

# BUILDING RESILIENT SUPPLY CHAINS, REVITALIZING AMERICAN MANUFACTURING, AND FOSTERING BROAD-BASED GROWTH

100-Day Reviews under  
Executive Order 14017

June 2021

*A Report by*  
The White House

*Including Reviews by*  
Department of Commerce  
Department of Energy  
Department of Defense  
Department of Health and Human Services



THE WHITE HOUSE  
WASHINGTON



**BUILDING RESILIENT SUPPLY CHAINS,  
REVITALIZING AMERICAN MANUFACTURING,  
AND FOSTERING BROAD-BASED GROWTH**

June 2021

# TABLE OF CONTENTS

INTRODUCTORY NOTE .....	4
EXECUTIVE SUMMARY FOR E.O. 14017 100-DAY REVIEWS .....	6
RECOMMENDATIONS.....	12
REVIEW OF SEMICONDUCTOR MANUFACTURING AND ADVANCED PACKAGING - DEPARTMENT OF COMMERCE.....	21
EXECUTIVE SUMMARY.....	22
INTRODUCTION.....	24
MAPPING THE SUPPLY CHAIN.....	26
RISK ASSESSMENT.....	53
GLOBAL FOOTPRINT.....	60
OPPORTUNITIES & CHALLENGES.....	66
RECOMMENDATIONS.....	74
ABBREVIATIONS.....	81
REVIEW OF LARGE CAPACITY BATTERIES - DEPARTMENT OF ENERGY.....	85
EXECUTIVE SUMMARY.....	86
INTRODUCTION.....	89
MAPPING OF THE SUPPLY CHAIN.....	93
RISK ASSESSMENT.....	119
GLOBAL FOOTPRINT.....	123
OPPORTUNITIES & CHALLENGES.....	129
RECOMMENDATIONS.....	134
ABBREVIATIONS.....	148
REVIEW OF CRITICAL MINERALS AND MATERIALS - DEPARTMENT OF DEFENSE .....	151
EXECUTIVE SUMMARY.....	152
INTRODUCTION.....	153
MAPPING THE SUPPLY CHAIN.....	155
GLOBAL FOOTPRINT.....	162
RISK ASSESSMENT.....	175
RECOMMENDATIONS.....	194
ABBREVIATIONS.....	204
REVIEW OF PHARMACEUTICALS AND ACTIVE PHARMACEUTICAL INGREDIENTS - DEPARTMENT OF HEALTH AND HUMAN SERVICES .....	207
EXECUTIVE SUMMARY.....	208
INTRODUCTION.....	210
MAPPING OF THE SUPPLY CHAIN.....	212
RISK ASSESSMENT.....	217
GLOBAL FOOTPRINT.....	233
OPPORTUNITIES & CHALLENGES.....	235
RECOMMENDATIONS.....	240
ABBREVIATIONS.....	250

# INTRODUCTORY NOTE

## FROM NATIONAL ECONOMIC COUNCIL DIRECTOR BRIAN DEESE AND NATIONAL SECURITY ADVISOR JAKE SULLIVAN TO THE PRESIDENT

Mr. President:

It is our privilege to transmit to you the first set of reports that your Administration has developed pursuant to Executive Order 14017, "America's Supply Chains." The enclosed reports assess supply chain vulnerabilities across four key products that you directed your Administration to review within 100 days: semiconductor manufacturing and advanced packaging; large capacity batteries, like those for electric vehicles; critical minerals and materials; and pharmaceuticals and advanced pharmaceutical ingredients (APIs).

The enclosed reports are the work of a task force that we convened across more than a dozen departments and agencies, consultations with hundreds of stakeholders, public comments submitted by industry and experts, and deep analytic research by experts from across the government. We would like to particularly thank the four agencies that took the lead in authoring each of the enclosed reports: the Department of Commerce on semiconductor manufacturing and advanced packaging; the Department of Energy on large capacity batteries; the Department of Defense on critical materials and minerals; and the Department of Health and Human Services, particularly the Food and Drug Administration, on pharmaceuticals and APIs. This work has complemented other work your Administration has undertaken to strengthen U.S. supply chains, including the work to dramatically expand the supply of COVID-19 vaccines and other products essential to American's health.

Departments and Agencies across your Administration have already begun to implement the reports' recommendations. These include steps to strengthen U.S. manufacturing capacity for critical goods, to recruit and train workers to make critical products here at home, to invest in research and development that will reduce supply chain vulnerabilities, and to work with America's allies and partners to strengthen collective supply chain resilience. Both the public and private sector play critical roles in strengthening supply chains, and your Administration will continue to work with industry, labor, and others to make America's supply chains stronger.

We have already launched the second phase of the supply chain initiative you directed in E.O. 14017, which reviews six critical industrial base sectors that underpin America's economic and national security: the defense industrial base, public health and biological preparedness industrial base, information and communications technology industrial base, energy sector industrial base, transportation industrial base, and supply chains for production of agricultural commodities and food products. We will report back to you on those sectors by February 24, 2022, the one-year mark of your signing E.O. 14017.

The 100-day reports make clear: more secure and resilient supply chains are essential to our national security, our economic security, and our technological leadership. The work of strengthening America's critical supply chains will require sustained focus and investment. Building manufacturing capacity, increasing job quality and worker readiness, inventing and commercializing new products, and strengthening relations with America's allies and partners will not be done overnight. We are committed to carrying this work forward across your Administration to ensure that America's critical supply chains are resilient and secure for the years to come.

JAKE SULLIVAN, Assistant to the President for  
National Security Affairs

BRIAN DEESE, Assistant to the President for  
Economic Policy and Director of the National  
Economic Council

# EXECUTIVE SUMMARY

## FOR E.O. 14017 REPORTS DUE JUNE 4, 2021

### I. Introduction:

The COVID-19 pandemic and resulting economic dislocation revealed long-standing vulnerabilities in our supply chains. The pandemic's drastic impacts on demand patterns for a range of medical products including essential medicines wreaked havoc on the U.S. healthcare system. As the world shifted to work and learn from home, it created a global semiconductor chip shortage impacting automotive, industrial, and communications products, among others. In February, extreme weather events—exacerbated by climate change—further exacerbated these shortages. In recent months the strong U.S. economic rebound and shifting demand patterns have strained supply chains in other key products, such as lumber, and increased strain on U.S. transportation and shipping networks.

On February 24, 2021, President Biden signed Executive Order (E.O.) 14017, "America's Supply Chains," in which he directed the U.S. government to undertake a comprehensive review of critical U.S. supply chains to identify risks, address vulnerabilities and develop a strategy to promote resilience. When the President signed the order, he invoked an old proverb: "For want of a nail, the shoe was lost. For want of a shoe, the horse was lost." And on, and on, until the kingdom was lost. Small failures at even one point in supply chains can impact America's security, jobs, families, and communities.

To undertake this comprehensive review, the Biden Administration established an internal task force spanning more than a dozen Federal Departments and Agencies. Administration officials consulted with hundreds of stakeholders from labor, business, academic institutions, Congress, and U.S. allies and partners to identify vulnerabilities and develop solutions. Federal Departments and Agencies received hundreds of written submissions in response to requests for public input into the supply chain initiative. Dozens of experts across the interagency have been conducting detailed studies of U.S. supply chains for critical products and developing policies that will strengthen resilience.

What follows summarizes the findings of the initial set of reviews of the supply chains of four critical products: semiconductor manufacturing and advanced packaging; large capacity batteries; critical minerals and materials and pharmaceuticals and active pharmaceutical ingredients (APIs).

#### *Why Resilient Supply Chains Matter*

More secure and resilient supply chains are essential for our national security, our economic security, and our technological leadership.

National security experts, including the Department of Defense, have consistently argued that the nation's underlying commercial industrial foundations are central to our security. Reports from both Republican and Democratic administrations have raised concerns about the defense industry's reliance on limited domestic suppliers;<sup>1</sup> a global supply chain vulnerable to disruption; and competitor country suppliers. Innovations essential to military preparedness—like highly specialized lithium-ion batteries—require an ecosystem of innovation, skills, and production facilities that the United States currently lacks. The disappearance of domestic production of essential antibiotics impairs our ability to counter threats ranging from pandemics to bio-terrorism, as emphasized by the FDA's analysis of supply chains for active pharmaceutical ingredients.

---

<sup>1</sup> Department of Defense, "Assessing and Strengthening the Manufacturing and Defense Industrial Base and Supply Chain Resiliency," 2018 (<https://media.defense.gov/2018/Oct/05/2002048904/-1/-1/1/ASSESSING-AND-STRENGTHENING-THE-MANUFACTURING-AND-DEFENSE-INDUSTRIAL-BASE-AND-SUPPLY-CHAIN-RESILIENCY.PDF>).

Our economic security—steady employment and smooth operations of critical industries—also requires secure and resilient supply chains. For more than a decade, the Department of Defense has consistently found that essential civilian industries would bear the preponderance of harm from a disruption of strategic and critical materials supply. The Department of Energy notes that, today, China refines 60 percent of the world's lithium and 80 percent of the world's cobalt, two core inputs to high-capacity batteries— which presents a critical vulnerability to the future of the U.S. domestic auto industry.

Finally, our domestic innovation capacity is contingent on a robust and diversified industrial base. When manufacturing heads offshore, innovation follows. The Department of Commerce notes that large-scale public investment in semiconductor fabrication has allowed Korean and Taiwanese firms to outpace U.S.-based firms. As the Department of Commerce warns, “ultimately, volume drives both innovation and operational learning; in the absence of the commercial volume, the United States will not be able to keep up [...] with the technology, in terms of quality, cost, or workforce.”

### *A New Approach*

A resilient supply chain is one that recovers quickly from an unexpected event. Our private sector and public policy approach to domestic production, which for years, prioritized efficiency and low costs over security, sustainability and resilience, has resulted in the supply chain risks identified in this report. That approach has also undermined the prosperity and health of American workers and the ability to manage natural resources domestically and globally. As the Administration sets out on a course to revitalize our manufacturing base and secure global supply chains, rebuilding for resilience at the national level requires a renewed focus on broad-based growth and sustainability.

America's approach to resilient supply chains must build on our nation's greatest strengths—our unrivaled innovation ecosystem, our people, our vast ethnic, racial, and regional diversity, our small and medium-sized businesses, and our strong relationships with allies and partners who share our values.

As multiple reports note, the United States maintains an unparalleled innovation ecosystem with world-class universities, research centers, start-ups and incubators, attracting top talent from around the world. The Administration must double-down on our innovation infrastructure, reinvesting in research and development (R&D) and accelerating our ability to move innovations from the lab to the marketplace.

American workers must be the foundation for resilience. Resilient production requires quick problem-solving, driven by the knowledge, leadership, and full engagement of people on the factory floor. Decades of focusing on labor as a cost to be controlled—not an asset to be invested in—have depressed real wages and driven down union-density for workers, while also contributing to companies' challenges finding and keeping skilled talent. We must focus on creating pathways for all Americans to access well paid jobs with the free and fair choice to organize and bargain collectively.

We must ensure that economic opportunities are available in all parts of the country and for women, people of color, and others who are too often left behind. Inequality in income, race, and geography is keeping millions of potential workers, researchers, and entrepreneurs from contributing fully to growth and innovation. Today, children with the talents to become inventors, are less likely to become patent holders if they are low-income, women, African American, Latino, or from disadvantaged regions<sup>2</sup>. The Administration's approach must provide access and pathways for these “lost Einsteins” — workers, researchers, and businesses-owners in the growing industries of the 21st century.

A robust and resilient supply chain must include a diverse and healthy ecosystem of suppliers. Therefore, we must rebuild our small and medium-sized business manufacturing base, which has borne the brunt of the hollowing out of U.S. manufacturing. We also need to diversify our international suppliers and reduce

---

<sup>2</sup> Alex Bell, Raj Chetty, Xavier Jaravel, Neviana Petkova, and John Van Reenan, “Who Becomes an Inventor in America? The Importance of Exposure to Innovation,” November 2018, Harvard University, ([http://www.equality-of-opportunity.org/assets/documents/inventors\\_summary.pdf](http://www.equality-of-opportunity.org/assets/documents/inventors_summary.pdf)).

geographic concentration risk. It is neither possible nor desirable to produce all essential American goods domestically. But for too long, the United States has taken certain features of global markets—especially the fear that companies and capital will flee to wherever wages, taxes and regulations are lowest—as inevitable. In the face of those same pressures, other countries successfully invested in policies that distributed the gains from globalization more broadly, including to workers and small businesses. We must press for a host of measures—tax, labor protections, environmental standards, and more—that help shape globalization to ensure it works for Americans as workers and as families, not merely as consumers. The Administration’s approach to resilience must focus on building trade and investment partnerships with nations who share our values—valuing human dignity, worker rights, environmental protection, and democracy.

Finally, a new set of risks confronts U.S. policy makers and business leaders. Technological change and the power of cyber-attacks to derail the critical industries—from energy to agriculture—require new public-private approaches to resilience. And, we must confront the climate crisis. Meeting U.S. decarbonization aims will involve a massive domestic build out of clean energy technology; for an issue so central to U.S. economic and national security, we cannot afford to be agnostic to where these technologies are manufactured and where the associated supply chains and inputs originate.

#### *A sector-by sector approach*

The Biden-Harris Administration has already begun to take steps to address supply chain vulnerabilities. The Administration’s COVID-19 Response Team has dramatically expanded the manufacture of vaccines and other essential supplies, enabling more than 137 million Americans to be fully vaccinated. The Administration has also worked with companies that manufacture and use computer chips to identify improvements in supply chain management practices that can strengthen the semiconductor supply chain over time. Just this year, the Department of Defense announced an investment in the expansion of the largest rare earth element mining and processing company outside of China. The Biden-Harris Administration is also working to address critical cyber vulnerabilities of U.S. supply chains and critical infrastructure, including issuing E.O. 14028 on “Improving the Nation’s Cyber Security” just last month. The recommendations we are releasing today build on this work and provide a path forward for greater investment and growth.

Not all recommendations will be relevant to all sectors, and a sector by sector approach will continue to be necessary. Methods of guarding against single-source risk in the critical minerals supply chain, for example, is limited in part by where natural resources exist. Tools including ally and friend-shoring, and stockpiling, along with investments in sustainable domestic production and processing will all be necessary to strengthen resilience. Sectors where we seek to advance our technological competitiveness—like high-capacity batteries—will require an ecosystem-building approach that includes supporting domestic demand, investing in domestic production, recycling and R&D, and targeting support of the U.S. automotive workforce.

The remainder of this executive summary covers the E.O. 14017 process, key vulnerabilities across the four initial critical supply chains; recommendations for securing these vulnerable supply chains; and immediate actions the administration should take to address transitory supply chain challenges.

## **II. Critical Supply Chains Identified in E.O. 14017:**

E.O. 14017 directed the government to focus initially on four key sets of products during the first 100 days following its signing. These initial priority products are:

- **Semiconductor manufacturing and advanced packaging:** Semiconductors are an essential component of electronic devices. The packaging, which may contain one or more semiconductors, provides an alternative avenue for innovation in density and size of products. Semiconductors have become ubiquitous in today’s world. They enable telecommunications and grid infrastructure, run critical business and government systems, and are prevalent across a vast array of products from fridges to fighter jets. A new car, for example, may require more than 100 semiconductors for touch screens, engine controls, driver assistance cameras, and other



systems.<sup>3</sup> The U.S. share of global semiconductor production has dropped from 37 percent in 1990 to 12 percent today, and is projected to decline further without a comprehensive U.S. strategy to support the industry.<sup>4</sup>

- **Large capacity batteries:** As the United States transitions away from fossil fuels for power generation and electrifies our automotive and trucking fleets, large capacity batteries for electric vehicles (EVs) and grid storage will be essential to U.S. economic and national security. Global demand for EV batteries is projected to grow from approximately 747 gigawatt hours (GWh) in 2020 to 2,492 gigawatt hours by 2025.<sup>5</sup> Absent policy intervention, U.S. production capacity is expected to increase to only 224 GWh during that period, but U.S. annual demand for passenger EVs will exceed that capacity.<sup>6</sup> Maintaining America's innovative and manufacturing edge in the automotive sector and other key industrial sectors will require the United States to undertake a concerted effort to shore-up sustainable critical material supply and processing capacity, expand domestic battery production, and support EV and storage adoption.
- **Critical minerals and materials:** The United States and other nations are dependent on a range of critical minerals and materials that are the building blocks of the products we use every day. Rare earths metals are essential to manufacturing everything from engines to airplanes to defense equipment. Demand for many of these metals is projected to surge over the next two decades, particularly as the world moves to eliminate net carbon emissions by 2050. For example, global demand for lithium and graphite, two of the most important materials for electric vehicle batteries, is estimated to grow by more than 4000 percent by 2040 in a scenario where the world achieves its climate goals, with graphite projected to grow nearly 2500 percent.<sup>7</sup> China was estimated to control 55 percent of global rare earths mining capacity in 2020 and 85 percent of rare earths refining.<sup>8</sup> The United States must secure reliable and sustainable supplies of critical minerals and metals to ensure resilience across U.S. manufacturing and defense needs, and do so in a manner consistent with America's labor, environmental, equity and other values.
- **Pharmaceuticals and active pharmaceutical ingredients (APIs):** The COVID-19 pandemic highlighted the critical importance of a resilient U.S. public health industrial base. We continue to address resilience challenges in the broader pandemic supply chain through actions prescribed in EO 14001, including a pandemic supply chain resilience strategy to be completed in July that will outline objectives and actions for long-term resilience. Thanks to the work by both government and the private sector, in less than a year the United States dramatically increased its capacity for vaccine production. But shortages of critical generic drugs and APIs have plagued the United States for years. Multiple factors, including lack of incentives to manufacture less profitable drugs and underinvestment in quality management, both at home and abroad, have resulted in

---

<sup>3</sup> Jack Ewing and Don Clark, "Lack of Tiny Parts Disrupts Auto Factories Worldwide," January 13, 2021, *The New York Times*, (<https://www.nytimes.com/2021/01/13/business/auto-factories-semiconductor-chips.html>).

<sup>4</sup> Antonio Varas, Raj Varadarajan, Jimmy Goodrich, and Falan Yinug, "Government Incentives and U.S. Competitiveness in Semiconductor Manufacturing," September, 2020, Boston Consulting Group and Semiconductor Industry Association, (<https://www.semiconductors.org/wp-content/uploads/2020/09/Government-Incentives-and-US-Competitiveness-in-Semiconductor-Manufacturing-Sep-2020.pdf>).

<sup>5</sup> "Lithium-Ion Battery Megafactory Assessment," Benchmark Mineral Intelligence, March 2021, (<https://www.benchmarkminerals.com/megafactories/>).

<sup>6</sup> Alice Yu and Mitzi Sumangil, "Top Electric Vehicle Markets Dominate Lithium-Ion Battery Capacity Growth," February 16, 2021, (<https://www.spglobal.com/marketintelligence/en/news-insights/blog/top-electric-vehicle-markets-dominate-lithium-ion-battery-capacity-growth>).

<sup>7</sup> International Energy Agency, "The Role of Critical Minerals in Clean Energy Transitions," May 2021, (<https://iea.blob.core.windows.net/assets/24d5dfbb-a77a-4647-abcc-667867207f74/TheRoleofCriticalMineralsinCleanEnergyTransitions.pdf>).

<sup>8</sup> Carl A. Williams, "China Continues Dominance of Rare Earths Markets to 2030, says Roskill," February 26, 2021, Mining.Com, (<https://www.mining.com/china-continues-dominance-of-rare-earths-markets-to-2030-says-roskill>).

fragile supply chains vulnerable to disruption. Further, 87 percent of generic API facilities are located overseas which has helped reduce costs by trillions of dollars in the past decade, but has left the U.S. health care system vulnerable to shortages of essential medicines.<sup>9</sup> While lack of data and supply chain transparency make it difficult to estimate the precise share of key U.S. drugs and APIs imported from abroad, China and India are estimated to control substantial parts of the supply chain.<sup>10</sup> A new approach is needed to ensure that Americans have reliable access to the life-saving medicines they need.

### III. Drivers of Supply Chain Vulnerability:

Across the four critical products—and the diverse supply chains that underpin them—the Administration assessed a wide range of supply chain risks and vulnerabilities. The Administration examined risks throughout the supply chains, from the sourcing of raw materials through the manufacture and distribution of finished goods. Across the reports, there are a set of inter-related themes and findings that contribute to supply chain vulnerabilities. These are:

1. **Insufficient U.S. manufacturing capacity:** U.S. manufacturing capabilities have declined over the several decades. The first decade of the century was particularly devastating for U.S. manufacturing with the loss of one-third of manufacturing jobs between 2000 and 2010.<sup>11</sup> Small and medium enterprises (SMEs) were particularly hard hit. Some of this decline can be attributed to competition from low wage nations—economists have estimated that about 25 percent of the job losses can be attributed to the rise of China, particularly following its entrance into the World Trade Organization.<sup>12</sup> But the United States has also seen productivity growth stagnate internally and compared to economic peers, for example, trailing Germany on average and in most industries.<sup>13</sup> Today, in the United States, SMEs are often less productive than large manufacturers. Counter to popular beliefs that “the robots are coming,” many SME manufacturers are underinvesting in new technology to increase their productivity.

Our loss of manufacturing capabilities has led to a loss in innovation capacity.<sup>14</sup> Manufacturing capabilities underpin innovation in a range of products and once lost, are challenging to build back. In recent decades, when production capacity headed overseas, the R&D and broader industrial supply chains often followed.

2. **Misaligned Incentives and short-termism in private markets:** All four reports make clear that current U.S. market structures fail to reward firms for investing in quality, sustainability or

---

<sup>9</sup> Food and Drug Administration, Testimony before the House Committee on Energy and Commerce, Subcommittee on Health regarding “Safeguarding Pharmaceutical Supply Chains in a Global Economy,” October 30, 2019, (<https://www.fda.gov/news-events/congressional-testimony/safeguarding-pharmaceutical-supply-chains-global-economy-10302019>).

<sup>10</sup> Yangzong Huang, “U.S. Dependence on Pharmaceutical Products from China,” August 14, 2019, Council on Foreign Relations Blog, (<https://www.cfr.org/blog/us-dependence-pharmaceutical-products-china>).

<sup>11</sup> Organization for Economic Cooperation and Development (OECD), “U.S. Manufacturing Decline and the Rise of New Production Innovation Paradigms,” 2016, (<https://www.oecd.org/unitedstates/us-manufacturing-decline-and-the-rise-of-new-production-innovation-paradigms.htm#:~:text=The%20number%20of%20manufacturing%20jobs,just%2012.3%20million%20in%202016>).

<sup>12</sup> David H. Autor, David Dorn, and Gordon H. Hanson, “The China syndrome: Local Labor Market Effects of Import Competition in the United States.” *American Economic Review* 103, no. 6, 2013 (<https://pubs.aeaweb.org/doi/pdfplus/10.1257/aer.103.6.2121>).

<sup>13</sup> Martin Neil Baily, Barry Bosworth, and Siddhi Doshi, “Productivity Comparisons: Lessons from Japan, the United States, and Germany,” 2019, The Brookings Institution (<https://www.brookings.edu/wp-content/uploads/2020/01/ES-1.30.20-BailyBosworthDoshi.pdf>).

<sup>14</sup> Gary P. Pisano and Willy C. Shih, Producing *Prosperity: Why America Needs a Manufacturing Renaissance* (Boston: Harvard Business Press, 2012).

long-term productivity. For example, about drug shortages over the past decade, the Department of Health and Human Services writes in its report, “the core of these failures is the inability of the market to reward quality.” A lower-wage and lower-skilled workforce may increase a firm’s quarterly earnings, but research suggests that “high-road” strategies can improve wages without harming profits.<sup>15</sup> Other kinds of investments—in capabilities for continuous improvement or in reducing lead time—incur an upfront cost, but lead to improved performance in both normal and crisis periods.<sup>16</sup> Under-investment in cyber security has left companies and critical infrastructure vulnerable to hacks and other cyberattacks.

A focus on maximizing short-term capital returns has led to the private sector’s underinvestment in long-term resilience. For example, firms in the S&P 500 Index distributed 91 percent of net income to shareholders in either stock buybacks or dividends between 2009 and 2018.<sup>17</sup> This has meant a declining share of corporate income going into R&D, new facilities or resilient production processes.

- 3. Industrial Policies Adopted by Allied, Partner, and Competitor Nations:** As U.S. investment in the domestic industrial base has declined, our allies, partners and competitors have adopted strategic programs to advance their own domestic competitiveness. The Department of Energy’s analysis of the advanced battery supply chain documents the European Union’s (EU) support for demand policies, investment incentives, and regulatory tools—at both the EU and member-state level—to stimulate domestic production of electric vehicles and lithium-ion batteries. After a 2019 EU report designating the battery of “strategic interest,” the EU announced a \$3.5 billion R&D fund to increase the industry’s competitiveness. The Department of Commerce’s analysis of the global semiconductor supply chain notes Taiwan—the global leader in production of the most advanced semiconductor chips—provides subsidies for fabrication facilities including 50 percent for land costs, 45 percent for construction and facilities and 25 percent for semiconductor, in addition to R&D investments and other incentives. South Korea’s and Singapore’s semiconductor subsidies reduce the cost of facility ownership by 25-30 percent.

Across all four reports, China stands out for its aggressive use of measures—many of which are well outside globally accepted fair trading practices—to stimulate domestic production and capture global market share in critical supply chains. Several strategies, including public investments in R&D, domestic demand incentives, and strategic international partnerships have been used to support both resilience and competitiveness of key economic sectors.

- 4. Geographic concentration in global sourcing:** To ensure resilient supply chains, it is essential that they be globalized. However, the search for low-cost production, combined with the effective industrial policy of key nations, has led to geographic concentrations of key supply chains in a few nations, increasing vulnerabilities for United States and global producers. Such concentration leaves companies vulnerable to disruption, whether caused by a natural disaster, a

---

<sup>15</sup> Thomas A. Kochan, Eileen Appelbaum, Jody Hoffer Gittel, and Carrie R. Leana, “The Human Capital Dimensions of Sustainable Investment: What Investment Analysts Need to Know,” February 22, 2013 ([https://papers.ssrn.com/sol3/papers.cfm?abstract\\_id=2222657](https://papers.ssrn.com/sol3/papers.cfm?abstract_id=2222657)).

<sup>16</sup> Suzanne de Treville and Lenos Trigeorgis, “It May Be Cheaper to Manufacture at Home.” *Harvard Business Review*, October 2010, (<https://hbr.org/2010/10/it-may-be-cheaper-to-manufacture-at-home>). JP MacDuffie, Daniel Heller, and Takahiro Fujimoto, “Building Supply Chain Continuity Capabilities for a Post-Pandemic World,” Wharton School Working Paper, 2021 (<https://mackinstitute.wharton.upenn.edu/2021/building-supply-chain-continuity-capabilities-for-a-post-pandemic-world>).

<sup>17</sup> William Lazonick, Mustafa Erdem Sakinç, and Matt Hopkins, “Why Stock Buybacks are Dangerous for the Economy,” *Harvard Business Review*, January 7, 2020 (<https://hbr.org/2020/01/why-stock-buybacks-are-dangerous-for-the-economy>).

geopolitical event or indeed, a global pandemic. From the studies conducted pursuant to E.O. 14017, it is clear in the Department of Commerce's report that the United States is dangerously dependent on specific countries for parts of the value chain of all of these products. The global economy depends on Taiwanese firms for 92 percent of leading-edge semiconductor production. China has over 75 percent of global cell fabrication capacity for advanced batteries, as noted in the Department of Energy's report. While the Department of Health and Human Services' data suggests India and China compete for market share of many U.S. medicines, industry analysis suggests India imports nearly 70 percent of its APIs from China.

- 5. Limited International Coordination:** Prior to the COVID-19 pandemic, the U.S. government under-invested in international diplomatic efforts to develop collective approaches to supply chain security. While expanded domestic production of critical goods must be part of the solution to America's supply chain vulnerabilities, the United States cannot manufacture all needed products at home. Moreover, the United States has a strong national interest in U.S. allies and partners improving the resilience of their critical supply chains in face of challenges—such as the COVID-19 pandemic, extreme weather events due to climate change, and geopolitical competition with China—that affect both the United States and our allies. Yet aside from a handful of pilot projects and other comparatively small diplomatic and multilateral initiatives to secure supply chains, the United States has not systematically focused on building international cooperative mechanisms to support supply chain resilience.

It will take a concerted effort over the short-, medium- and long-term to adequately address these and put U.S. supply chains on stronger footing. The following recommendations provide an overarching framework for doing so that will ensure the country's national and economic security as well as technological leadership going forward.

## RECOMMENDATIONS

The four reports delivered to the President today contain numerous recommendations to strengthen the individual product supply chains. There are also several cross-cutting themes and recommendations that, collectively, will not only strengthen the four prioritized supply chains, but also will rebuild the U.S. industrial base and innovation engine.

We divide the recommendations into six categories: 1) Rebuilding our production and innovation capabilities; 2) supporting the development of markets with high road production models, labor standards, and product quality; 3) leveraging the government's role as a market actor; 4) strengthening international trade rules, including trade enforcement mechanisms; 5) working with allies and partners to decrease vulnerabilities in the global supply chains; and 6) partnering with industry to take immediate action to address existing shortages.

### 1. Rebuild our production and innovation capabilities

Long-term competitiveness will require an ecosystem of production, innovation, skilled workers, and diverse small and medium-sized suppliers. Those ecosystems, grounded in regions across the country, are the infrastructure needed to spur private sector investment in manufacturing and innovation. But that infrastructure will not be rebuilt or sustained without the support and leadership of the federal government. Specific recommendations to rebuild our industrial base include:

*Enact new federal legislation that will strengthen critical supply chains and rebuild our industrial base—including transformative investments within the American Jobs Plan:*

- **Provide dedicated funding for semiconductor manufacturing and R&D:** We recommend that Congress support at least \$50 billion in investments to advance domestic manufacturing of leading edge semiconductors; expand capacity in mature node and memory production to

support critical manufacturing, industrial, and defense applications; and promote R&D to ensure the next generation of semiconductors is developed and produced in the United States.

- **Provide consumer rebates and tax incentives to spur consumer adoption of EVs:** We recommend Congress authorize new and expanded incentives to spur consumer adoption of U.S.-made electric vehicles. In addition, we recommend Congress approve \$5 billion to electrify the federal fleet with U.S.-made EVs and \$15 billion in infrastructure investment to build a national charging infrastructure to facilitate the nationwide adoption of EVs.
- **Provide financing across the full battery supply chain:** In line with the American Jobs Plan, we recommend that Congress establish new incentives to support battery cell and pack manufacturing in the United States, including grant programs that can help entrepreneurs who do not have the ability to access tax credits in the short run. In the immediate term, the Department of Energy's Loan Programs Office should use the Advanced Technology Vehicles Manufacturing Loan Program, which has approximately \$17 billion in loan authority, to expeditiously review applications from critical material and mineral refining and processing facilities and to re-equip, expand, or establish facilities for manufacturing advanced technology vehicle battery cells and packs in the United States.
- **Establish a new Supply Chain Resilience Program:** We recommend that Congress enact the proposed Supply Chain Resilience Program at the Department of Commerce, to monitor, analyze, and forecast supply chain vulnerabilities and partner with industry, labor, and other stakeholders to strengthen resilience. We recommend Congress back this program with \$50 billion in funding that will give the federal government the tools necessary to make transformative investments in strengthening U.S. supply chains across a range of critical products.
- **Deploy the Defense Production Act (DPA) to expand production capacity in critical industries:** We recommend establishing a new interagency DPA Action Group to recommend ways to leverage the authorities of the DPA to strengthen supply chain resilience to the extent permitted by law. The DPA has been a powerful tool to expand production of supplies needed to combat the COVID-19 pandemic, and has been used for years to strengthen Department of Defense supply chains. The DPA has the potential to support investment in other critical sectors and enable industry and government to collaborate more effectively.

*Increase public investments in R&D and commercialization of key products:*

- **Invest in the development of next generation batteries:** We recommend that the Energy Department and other federal agencies continue to support technologies that will reduce the critical mineral requirements of next generation electric vehicle and grid storage technologies, and that improve U.S. competitiveness in this critical sector. Among other priorities, the United States should focus on: (1) reducing or eliminating critical or scarce materials needed for EV or stationary storage, including cobalt and nickel; (2) accelerating battery technology advances including next generation lithium ion and lithium metal batteries and solid state design, and (3) developing innovative methods and processes to profitably recover "spent" lithium batteries, reclaim key materials, and re-introduce those materials to the battery supply chain.
- **Invest in the development of new pharmaceutical manufacturing and processes:** We recommend the Department of Health and Human Services, the Department of Defense, and other agencies increase their funding of advanced manufacturing technologies to advance continuous manufacturing and the biomanufacturing of APIs. American Rescue Plan funds

could be targeted to increase production of key pharmaceuticals and ingredients, including using both traditional manufacturing techniques and accelerating on-demand manufacturing capabilities for supportive care fluids, API and finished dosage form drugs in modular, highly portable platforms.

*Use immediate administrative authorities to support an ecosystem of producers and innovators including SMEs and skilled workers:*

- **Work with industry and labor to create pathways to quality jobs, with a free and fair choice to join a union, through sector-based community college partnerships, apprenticeships and on-the-job training:** The Department of Labor's Employment and Training Administration (ETA) should support sector-based pathways to jobs, for example in the semiconductor industry. We recommend that the Administration use ETA funds to work with industry and labor, community colleges, and non-profit partners to support pathways to advanced manufacturing employment through Registered Apprenticeship programs and by supporting other labor-management training programs.
- **Support small, medium and disadvantaged businesses in critical supply chains:** The Small Business Administration (SBA) should support the diversification of critical suppliers through a targeted effort to better coordinate SBA's range of investment and technical assistance programs for small businesses and disadvantaged firms in the four targeted industries and firms seeking to enter those industries. SBA lending and investment products provide vital capital to small businesses, and the Small Business Investment Company program offers long-term equity investment in critical competitiveness sectors. The Small Business Innovation Research and Small Business Technology Transfer competitive programs, will support a diverse portfolio of small businesses to meet research and development needs, and increase commercialization.
- **Examine the ability of the U.S. Export-Import Bank (EXIM) to use existing authorities to further support domestic manufacturing:** We recommend that EXIM develop a proposal for Board consideration regarding whether and how to implement a new Domestic Financing Program to support the establishment and/or expansion of U.S. manufacturing facilities and infrastructure projects in the United States that would support U.S. exports. The proposal would support and facilitate U.S. exports while rebuilding U.S. manufacturing capacity.

## **2. Support the development of markets that invest in workers, value sustainability, and drive quality**

The resilience of national supply chains is only as good as the resilience of supply chains at the firm level. Harnessing and unleashing the power and ingenuity of the private sector to improve resilience will lead to stronger national supply chain resilience. Standards and data are powerful tools that allow firms to differentiate their products and services on more than just price and create market "pull" toward a "race to the top". These reports identify key areas where government could play a more active role in setting standards and incentivizing high-road business practices. By establishing strong domestic standards or advocating for the establishment of global standards, the United States can support the private sector's ability to create and adopt resilient practices.

- **Create 21st century standards for the extraction and processing of critical minerals:** We recommend that the government, working with private sector and non-governmental stakeholders, encourage the development and adoption of comprehensive sustainability standards for essential minerals, such as lithium, cobalt, nickel, copper, and other minerals. We further recommend establishing an interagency team with expertise in mine permitting and environmental law to identify gaps in statutes and regulations that may need to be updated to ensure new production meets strong environmental standards throughout the lifecycle of the project; ensure meaningful community consultation and consultation with tribal nations,

respecting the government-to-government relationship, at all stages of the mining process; and examine opportunities to reduce time, cost, and risk of permitting without compromising these strong environmental and consultation benchmarks.

- **Identify potential U.S. production and processing locations for critical minerals:** We recommend that federal agencies, led by the Department of Interior with the support of the White House Office of Science and Technology Policy, establish a working group comprised of agencies such as the Department of Agriculture, the Environmental Protection Agency, and others to identify potential sites where critical minerals could be sustainably and responsibly produced and processed in the United States while adhering to the highest environmental, labor, community engagement, and sustainability standards. We recommend that federal agencies work with the private sector, states, tribal nations, and stakeholders—including representatives of labor, impacted communities, and environmental justice leaders—to expand sustainable, responsible critical minerals production and processing in the United States.
- **Improve transparency throughout the pharmaceuticals supply chain:** HHS should develop and make recommendations to Congress on providing the department with new authorities to track production by facility, track API sourcing, and require API and finished dosage form sources can be identified on labeling for all pharmaceuticals sold in the United States. Currently, there is little transparency into the origins of API within generic drugs, which represent, 90 percent of all pharmaceuticals consumed in the United States.

### 3. Leverage the government's role as a purchaser of and investor in critical goods

As a significant customer and investor, Federal Government has the capacity to shape the market for many critical products. The public sector can deploy this power in times of crisis—such as in the recent public-private partnerships to facilitate development and delivery of a COVID-19 vaccine—or in normal times. The Administration should leverage this role to strengthen supply chain resilience and support national priorities.

- **Use federal procurement to strengthen U.S. supply chains:** We recommend that, in connection with the Administration's "Made in America" process directed by E.O. 14005, the Biden Administration establish a list of designated critical products that it recommends receive additional preferences under the Buy American Act and FAR Council regulations to ensure that the federal government procures U.S.-made critical products. President Biden has directed the Administration to strengthen federal Buy American requirements, which require that U.S. taxpayer dollars generally be spent on products made in the United States. Federal procurement has the potential to support U.S. production of critical products by creating a stable source of demand for U.S.-made products—thereby providing an incentive for the private sector to invest in U.S. manufacturing.
- **Strengthen domestic production requirements in federal grants for science and climate R&D:** In line with the President's campaign commitments, we recommend that Biden-Harris Administration should update manufacturing requirements in federal grants, cooperative agreements and R&D contracts to ensure that taxpayer funded R&D leads to products made in the United States. We recommend that the Department of Energy immediately strengthen domestic manufacturing requirements for grants, cooperative agreements and R&D contracts, including those related to lithium batteries, using the Determinations of Exceptional Circumstances under the Bayh-Dole Act and other legal means. In addition, an interagency working group should be established to identify best-practices and develop and implement further improvements across the government.

- **Reform and strengthen U.S. stockpiles:** For too long, the strategic stockpiles of the United States have been neglected, and at times, its funds have been used to offset other costs. The rehabilitation of stockpiles of medical goods and devices, especially those to fight the ongoing COVID-19 pandemic, is already under way. However, similar action needs to be taken to recapitalize and restore the National Defense Stockpile of critical minerals and materials. In the private sector, we recommend that industries that have faced shortages of critical goods evaluate mechanisms to strengthen corporate stockpiles of select critical products to ensure greater resilience in times of disruption.
- **Ensure that new automotive battery production in the United States adheres to high labor standards:** Tax credits, lending and grants offered to businesses to produce batteries domestically should, to the extent permitted by law, ensure the creation of quality jobs with the free and fair choice to organize and bargain collectively for workers. In new appropriations, we recommend that Congress include prevailing wage requirements, similar to those included in the American Recovery and Reinvestment Act of 2009. We recommend that Congress also include standards that cover construction, such as: (1) mandated hiring percentages from registered apprenticeships and other labor or labor-management training programs; (2) project labor, community labor and local hire requirements; and (3) employer neutrality agreements. We recommend implementing similar standards for production workers. The resulting high productivity allows these firms both to pay high wages and be profitable.<sup>18</sup>

#### 4. Strengthen international trade rules, including trade enforcement mechanisms

While the Administration welcomes fair competition from abroad, in too many circumstances unfair foreign subsidies and other trade practices have adversely impacted U.S. manufacturing and more broadly, U.S. competitiveness. The practice of "pumping and dumping," in which countries heavily subsidize an industry, gain market share and then flood the market with cheaper products to wipe out competition, has been documented in a number of industries including pharmaceuticals and clean energy.<sup>19</sup> The U.S. government must implement a comprehensive strategy to push back on unfair foreign competition that erodes the resilience of U.S. critical supply chains and industries more broadly.

- **Establish a trade strike force:** We recommend the establishment of a U.S. Trade Representative-led trade strike force to identify unfair foreign trade practices that have eroded U.S. critical supply chains and to recommend trade actions to address such practices. We also recommend that supply chain resilience be incorporated into the U.S. trade policy approach towards China. We also recommend that the trade strike force examine how existing U.S. trade agreements and future trade agreements and measures can help strengthen the United States and collective supply chain resilience.
- **Evaluate whether to initiate a Section 232 investigation on imports of neodymium magnets:** Neodymium (NdFeB) permanent magnets play a key role in motors and other devices, and are important to both defense and civilian industrial uses. Yet the U.S. is heavily dependent on imports for this critical product. We recommend that the Department of Commerce evaluate whether to initiate an investigation into neodymium permanent magnets under Section 232 of the Trade Expansion Act of 1962.

---

<sup>18</sup> Susan Helper, Ryan Noonan, Jessica R. Nicholson, and David Langon, "The Benefits and Costs of Apprenticeship: A Business Perspective," Department of Commerce with Case Western Reserve University, November 2016 (<https://files.eric.ed.gov/fulltext/ED572260.pdf>).

<sup>19</sup> Chris Martin, "China Flooded U.S. with Solar Panels Before Trump's Tariffs," *Bloomberg*, February 16, 2018 (<https://www.bloomberg.com/news/articles/2018-02-16/china-flooded-u-s-with-solar-panels-before-trump-s-tariffs>).



## 5. Work with allies and partners to decrease vulnerabilities in the global supply chains

The United States cannot address its supply chain vulnerabilities alone. Even as we make investments to expand domestic production capacity for some critical products, we must work with allies and partners to secure supplies of critical goods that we will not make in sufficient quantities at home. Moreover, in an interconnected world, the United States has a strong interest in ensuring its allies and partners have resilient supply chains as well. We must work with America's allies and partners to strengthen our collective supply chain resilience, while ensuring high standards for labor and environmental practices are upheld.

- **Expand multilateral diplomatic engagement, including hosting a new Presidential Forum:** We recommend expanding multilateral diplomatic engagement on supply chain vulnerabilities, particularly through groupings of like-minded allies such as the Quad and G7. We also recommend that the President convene a global forum on supply chain resilience that will convene key government officials and private sector stakeholders from across key U.S. allies and partners to collectively assess vulnerabilities and develop collective approaches to supply chain resilience.
- **Leverage the U.S. Development Finance Corporation (DFC) and other financing tools to support supply chain resilience:** We recommend that the DFC increase capacity for investments in projects that will expand production capability for critical products, including critical minerals and other products identified pursuant to the E.O. 14017 process. U.S. development and international finance tools offer a powerful avenue for working with allies and partners to strengthen supply chains for key products. While the United States cannot manufacture or mine all products, it can use financial tools to ensure that the manufacturing and mining that takes place elsewhere supports supply chain resilience and upholds international standards of environmental and social performance.

## 6. Monitor near term supply chain disruptions as the economy reopens from the COVID-19 pandemic

The U.S. economic relief efforts, paired with the Administration's successful vaccination campaign, have helped to revive the U.S. economy after a historic pandemic. As the United States and the broader global economy emerge from the pandemic, we have already seen signs of new pressures on supply chains as shifts in demand and supply emerge, and as the global vaccination campaign continues.

While these short-term disruptions are to be expected, the Administration has the responsibility to monitor these developments closely and identify actions that can be taken to minimize the impacts on workers, consumers, and businesses.

Building off the lessons from the 100-day review, the Administration should:

- **Establish a Supply Chain Disruptions Task Force:** We recommend the Administration establish a new Supply Chain Disruptions Task Force that will provide an all-of-government response to address near-term supply chain challenges to the economic recovery. The Task Force will be led by the Secretaries of Commerce, Transportation, and Agriculture and will focus on areas where a mismatch between supply and demand has been noted over the past several months: homebuilding and construction, semiconductors, transportation, and agriculture and food. The Task Force will bring the full capacity of the federal government to address near-term supply/demand mismatches. It will convene stakeholders to diagnose problems and surface solutions—large and small, public or private—that could help alleviate bottlenecks and supply constraints.
- **Create a data hub to monitor near term supply chain vulnerabilities:** We recommend that the Commerce Department lead a coordinated effort to bring together data from across the federal government to improve the federal government's ability to track supply and demand

disruptions and improve information sharing between federal agencies and the private sector to more effectively identify near term risks and vulnerabilities.





**REVIEW OF SEMICONDUCTOR MANUFACTURING  
AND ADVANCED PACKAGING**

**DEPARTMENT OF COMMERCE**

## EXECUTIVE SUMMARY

Semiconductors are the material basis for integrated circuits that are essential to modern day life and are used by the typical consumer on a daily, if not hourly, basis. The semiconductor-based integrated circuit is the “DNA” of technology and has transformed essentially all segments of the economy, from agriculture and transportation to healthcare, telecommunications, and the Internet. The semiconductor industry is a major engine for U.S. economic growth and job creation. Semiconductors are used in virtually every technology product and underpin state-of-the-art military systems. Semiconductors are an integral part of a consumer’s everyday life and can be found in household items such as light switches, garage door openers, and refrigerators, as well as in more complex products such as mobile phones, computers, and automobiles.

The U.S. semiconductor industry accounts for nearly half of global semiconductor revenue, yet the share of semiconductor manufacturing capacity on U.S. soil has fallen from 37 percent 20 years ago and stands at about 12 percent of global production. U.S. companies, including major fabless semiconductor companies, depend on foreign sources for semiconductors, especially in Asia, creating a supply chain risk. Many of the materials, tools, and equipment used in the manufacture of semiconductors are available from limited sources, semiconductor manufacturing is geographically concentrated, and the production of leading-edge semiconductors requires multi-billion dollar investments.

The COVID-19 pandemic demonstrates the importance of semiconductors to meeting the world’s most urgent challenges including their use in enabling technology for finding treatments, caring for patients, working and studying from home, and ordering groceries and other essential products. Shortages of certain semiconductors during the pandemic also reveal the importance of ensuring stable, resilient supply chains for these vital products. The industry is currently undergoing a shortage due to multiple factors, including unexpected shifts in global demand following the COVID-19 pandemic and events that disrupted specific major semiconductor manufacturing centers, such as the early 2021 storms in Texas that caused a shutdown of several semiconductor manufacturing plants.

This report examines the semiconductor supply chain through five related essential segments: (1) design; (2) fabrication; (3) assembly, test, and packaging (ATP) and advanced packaging; (4) materials; and (5) manufacturing equipment.

- **Design:** The U.S. semiconductor design ecosystem is robust and world leading, but U.S. companies are highly dependent on sales to China for continued profit growth and domestic research and development (R&D) investment. In addition, U.S. design companies depend on limited sources of intellectual property (IP), labor, and manufacturing that are essential to bring products to market.
- **Fabrication:** The United States lacks sufficient capacity to produce semiconductors. The United States relies primarily on Taiwan for leading edge logic chips and relies on Taiwan, South Korea, and China to meet demand for mature node chips.
- **ATP and Advanced Packaging:** For relatively low-tech back-end semiconductor ATP, the United States is heavily reliant on foreign sources concentrated in Asia. Furthermore, as chips become increasingly complex, advanced packaging methods represent a potential area for significant technological advances. However, the United States lacks the necessary materials ecosystem and is also not a cost-effective location to develop a robust advanced packaging sector while massive Chinese investments threaten to upend the market.
- **Materials:** The production of semiconductors requires hundreds of materials, presenting challenges in manufacturing supply chains. Many of the gases and wet chemicals for semiconductors are produced in the United States, but foreign suppliers dominate the market for silicon wafers, photomasks, and photoresists.
- **Manufacturing Equipment:** The United States has a significant share of global production of most types of front-end semiconductor manufacturing equipment, with the notable exception of lithography

equipment production, which is concentrated in the Netherlands and Japan. With limited semiconductor manufacturing occurring in the United States, these equipment manufacturers are heavily reliant on sales outside of the United States.

This review identifies eight cross-cutting risks that encompass most of the identified threats to semiconductor supply chains: (1) fragile supply chains; (2) malicious supply chain disruptions; (3) use of obsolete and generations-old semiconductors and related challenges for continued profitability of companies in the supply chain; (4) customer concentration and geopolitical factors; (5) electronics production network effects; (6) human capital gaps; (7) IP theft; and (8) challenges in capturing the benefits of innovation and aligning private and public interests.

The following policy recommendations are designed to address the current semiconductor shortage and the risks identified in the report:

- 1. Promote investment, transparency, and collaboration, in partnership with industry, to address the semiconductor shortage.** While the private sector must take the lead in addressing the shortage in the near term, U.S. government can assist in mitigating the current shortage by redoubling partnerships with industry to facilitate information flow between semiconductor producers and suppliers and end-users; strengthening engagement with allies and partners to promote fair semiconductor chip allocations and increased investment and to increase production; and advancing the adoption of effective semiconductor supply chain management and security practices by companies.
- 2. Fund the Creating Helpful Incentives for Production of Semiconductors (CHIPS) for America provisions in the Fiscal Year (FY) 2021 National Defense Authorization Act (NDAA),** which authorized programs to: (1) incentivize manufacturing through federal financial assistance to construct, expand, or modernize semiconductor-related facilities to support semiconductor fabrication, ATP, and advanced packaging; and (2) advance R&D technology prototyping via a new National Semiconductor Technology Center (NSTC).
- 3. Strengthen the Domestic Semiconductor Manufacturing Ecosystem** through legislative action to implement the ideas put forth in President Biden's American Jobs Plan provide incentives to support key upstream—including semiconductor manufacturing equipment, materials, and gases—and downstream industries to offset high operational costs in the United States, continued support for investment in the United States through programs like the Department of Commerce International Trade Administration's SelectUSA; and support for manufacturing through a new Department of Commerce National Institute of Standards and Technology (NIST) Manufacturing USA Institute, as requested in the President's 2022 Budget.
- 4. Support Manufacturers, Particularly Small and Medium-Size Businesses** via R&D resources to prove emerging technologies and financing to move from the lab to market and address capital needs for growth.
- 5. Build a Diverse and Accessible Talent Pipeline for Jobs in the Semiconductor Industry** through significant investments to grow and diversify the STEM talent pipeline, the Department of Labor's Employment and Training Administration sector-based pathways and training programs, public/private investments to help fund workforce development, and changes in immigration policies to attract the world's best and brightest minds.
- 6. Engage with Allies and Partners on Semiconductor Supply Chain Resilience** by encouraging foreign foundries and materials suppliers to invest in the United States and other allied and partner regions to provide a diverse supplier base, pursuing R&D partnerships, and harmonizing policies to address market imbalances and non-market actors.
- 7. Protect U.S. Technological Advantage in Semiconductor Manufacturing and Advanced Packaging** by ensuring that export controls support policy actions to address national security and foreign policy concerns related to the semiconductor manufacturing and advanced packaging supply

chain and that foreign investment reviews consider national security considerations in the semiconductor and advanced packaging supply chain.

## INTRODUCTION

Semiconductors are the material basis for integrated circuits that are essential to modern day life and are used by the typical consumer on a daily, if not hourly, basis. The semiconductor-based integrated circuit is the “DNA” of technology and has transformed essentially all segments of the economy, from agriculture and transportation to healthcare, telecommunications, and the Internet. The semiconductor industry is a major engine for U.S. economic growth and job creation. Semiconductors are used in virtually every technology product and underpin state-of-the-art military systems. Semiconductors are an integral part of a consumer’s everyday life and can be found in household items such as light switches, garage door openers, and refrigerators, as well as in more complex products such as mobile phones, computers, and automobiles.

According to the most recent data from the Bureau of the Census, about 733 firms located in the United States were involved in semiconductor device manufacturing (North American Industry Classification System (NAICS) 334413)<sup>1</sup> in 2017, and an additional 140 firms manufactured the equipment used to make semiconductors (NAICS 333242).<sup>2</sup> The majority of these firms are small: only 69 semiconductor device manufacturers and 22 semiconductor machinery manufacturers have 500 employees or more.<sup>3</sup> Measured by value added, these two semiconductor industry sectors contributed \$35 billion to the U.S. economy in 2019, accounting for approximately 1.4 percent total U.S. manufacturing value added.<sup>4</sup>

The two semiconductor industry-related NAICS categories directly employed 207,400 workers in 2019, accounting for 1.6 percent of total U.S. manufacturing employment. These are high-quality, well-paying jobs: the semiconductor manufacturing workforce earned an average of \$163,871 per person in 2019, more than twice the average for all U.S. manufacturing workers (\$69,928).<sup>5</sup> Eighteen U.S. states have major semiconductor manufacturing operations, according to the Semiconductor Industry Association (SIA).

These statistics, however, capture only a portion of the overall semiconductor industry and therefore understate its importance to the U.S. economy. Information on the broader industry further highlights its importance to the U.S. economy. SIA estimates that the U.S. semiconductor industry had \$208 billion in annual sales in 2020, capturing nearly half of the world market. Despite the global COVID-19 pandemic, worldwide sales of semiconductors increased by 6.5 percent in 2020. SIA estimates the global semiconductor market will reach \$726 billion in annual sales by 2027, a compound annual growth rate of 4.7 percent. Further, SIA estimates that each direct job in the semiconductor industry supports nearly five additional jobs.<sup>6</sup> Semiconductors are also a major export for the United States with \$47 billion in export sales in 2020, ranking fourth overall, after aircrafts, refined oil, and crude oil.<sup>7</sup>

Semiconductors power virtually every sector of the economy—including energy, healthcare, agriculture, consumer electronics, manufacturing, defense, and transportation. Worldwide demand for semiconductors in 2019 by end use was: mobile phones (26 percent), information and communications infrastructure (including data centers, communications networks) (24 percent); computers (19 percent), industrial (12 percent),

---

<sup>1</sup> Note that NAICS 334413 also includes manufacturers of “related devices” such that are not the subject of this review, such as laser and light emitting diodes, fuel cells, and solar cells.

<sup>2</sup> Covered by NAICS 334413 and 333242, respectively.

<sup>3</sup> “2017 SUSB Annual Data Tables by Establishment Industry”, (U.S. Census Bureau, March 2020).

<sup>4</sup> “2019 Annual Survey of Manufactures (ASM), NAICS 333242 and 334413” (U.S. Census Bureau, 2019).

<sup>5</sup> Bureau of Labor Statistics, Quarterly Census of Earnings and Wages, NAICS 333242 and 334413.

<sup>6</sup> “Semiconductor Industry Association Briefing to the Bureau of Industry and Security”, (Semiconductor Industry Association, February 21 2021); “Chipping In: The Positive Impact of the Semiconductor Industry on the American Workforce and How Federal Incentives Will Increase Domestic Jobs”, (Semiconductor Industry Association, May 2021).

<sup>7</sup> Dataweb, “U.S. Census Trade Statistics”, (U.S. International Trade Commission, 2020).



automotive (10 percent), and consumer electronics (10 percent).<sup>8</sup> Among these diverse applications, those that directly support national security and critical infrastructure account for about nine percent of semiconductor demand. These critical semiconductor end uses include defense and aerospace, telecommunications networks, energy and utilities, healthcare, and financial services.<sup>9</sup> Defense and other government use is slightly over one percent of worldwide consumption of semiconductors.<sup>10</sup>

In addition to the central role they play in the U.S. economy, semiconductors are essential to national security. Semiconductors enable the development and fielding of advanced weapons systems and control the operation of the nation's critical infrastructure. They are fundamental to the operation of virtually every military system, including communications and navigations systems and complex weapons systems such as those found in the F-35 Joint Strike Fighter. They are key to the "must-win" technologies of the future, including artificial intelligence and 5G, which will be essential to achieving the goal of a "dynamic, inclusive and innovative national economy" identified as a critical American advantage in the March 2021 Interim National Security Strategic Guidance.<sup>11</sup> In addition, the development of advanced autonomous systems, cybersecurity, space and hypersonics, and directed energy is also dependent on semiconductor technologies.

The COVID-19 pandemic further increased the importance of semiconductors. Semiconductors have been an enabling technology for finding treatments, caring for patients, working and studying from home, and ordering groceries and other essential products, demonstrating the important role that semiconductors play in meeting both the nation's and the world's most urgent challenges and crises. Shortages of certain semiconductors during the pandemic also reveal the importance of ensuring stable, resilient supply chains for these vital products.

A sudden supply chain shock could have a far-reaching and unforeseen impact in any of these areas, not only for specific industries, communities, and workers, but also potentially affecting national security and critical infrastructure. For example, SIA estimates that a disruption in the production of logic chips at foundries in Taiwan could result in nearly \$500 billion in lost revenues for electronic devices manufacturers that depend on this supply.<sup>12</sup>

The semiconductor industry is currently undergoing just this type of supply disruption. In mid-2020, a global chip shortage began to emerge when automakers warned that relatively inexpensive semiconductors used in automobiles were becoming scarce and that this would potentially disrupt vehicle production. The initial disruption was due to major demand shocks from the COVID-19 pandemic. In the second quarter of 2020, at the height of the pandemic-related economic slowdown, auto parts suppliers cancelled orders for chips due to a six-week industry shutdown to mitigate the spread of the pandemic at vehicle and part manufacturing facilities. Parts suppliers also sought to limit inventories and costs in anticipation of a predicted fall in vehicle demand during a post-pandemic recession.<sup>13</sup> At the same time, the rapid shift to a work-from-home economy driven by the pandemic dramatically increased demand for electronic devices including video-game systems, computers, laptops, and other electronics and for the digital infrastructure and storage to support the increased on-line activity. Based on buyer demand and orders, semiconductor suppliers shifted production and foundry orders away from automotive-grade chips where demand was falling to business and consumer electronics chips where demand was spiking.

---

<sup>8</sup> Varas et al. "Strengthening The Global Semiconductor Supply Chain In An Uncertain Era", (Boston Consulting Group and Semiconductor Industry Association, April 2021).

<sup>9</sup> "Supply Chain Briefing to the U.S. Department of Commerce", (Semiconductor Industry Association, March 31 2021).

<sup>10</sup> Falan Yinug, "The 2020 SIA Factbook: Your Source for Semiconductor Industry Data", (Semiconductor Industry Association, April 23 2020).

<sup>11</sup> "Renewing America's Advantages: Interim National Security Strategic Guidance", (The White House, March 2021).

<sup>12</sup> Varas et al. "Strengthening The Global Semiconductor Supply Chain In An Uncertain Era"

<sup>13</sup> "Why is there a shortage of semiconductors?", (The Economist, February 25 2021).

In contrast to early projections, vehicle demand recovered much more quickly than expected in the second half of 2020. This sharp rebound impacted the auto industry in part due to its just-in-time supply chains and limited visibility into upstream suppliers. When auto parts suppliers returned to place orders for chips to meet the unanticipated surge in vehicle demand, semiconductor manufacturers had reportedly already utilized spare capacity to produce chips for electronics devices.<sup>14</sup> Because manufacturing a chip can take up to 26 weeks,<sup>15</sup> and sometimes much longer when supply is tight, production volumes are usually confirmed six months in advance, and it can take months to switch a production line from one type of chip to another. A further complication for the automotive industry is that automotive grade chips can only be produced by qualified producers and they require extensive testing to meet rigorous quality and vehicle safety requirements. These requirements are burdensome—both in time and cost—to the semiconductor producers, particularly when compared to the less stringent requirements for the relatively higher-margin chips for consumer good applications.

Further exacerbating the semiconductor supply shortage was a fire that occurred in March 2021 at a Japanese semiconductor plant that accounts for 30 percent of the market for microcontrollers used in cars. The company, Renesas Electronics Corporation indicated it would take at least 100 days for production to normalize at the plant.<sup>16</sup> In addition, the worst drought in half a century is affecting Taiwan, further straining semiconductor manufacturing, which requires vast quantities of water.<sup>17</sup> Finally, storms in February 2021 caused loss of utilities to semiconductor manufacturer NXP's two plants in Austin, Texas. It took nearly a month for NXP to resume normal operations.<sup>18</sup>

For the auto sector, which relies on chips for functions including braking, power steering, engine controls and safety systems, it means that vehicles cannot be assembled to completion. Automakers are idling plants and furloughing workers as they are unable to maintain production lines as they wait for parts. This shortage will cost the global automobile industry an estimated \$110 billion in 2021 and will lead to the production of nearly four million fewer vehicles than automakers had planned.<sup>19</sup>

In April 2021, reports began to indicate that the semiconductor shortage had expanded to other sectors. As of April 30<sup>th</sup>, Goldman Sachs estimated that a total of 169 U.S. industries were being directly affected by the shortage.<sup>20</sup> Scarce supply also means rising costs for industry and consumers. Given the reliance on microchips in nearly every industry, the widening shortage means a sustained loss of commercial opportunities just as consumer demand is poised to increase as much of the world is emerging from the pandemic. Several semiconductor companies predict that the shortage will last until 2022.<sup>21</sup>

## MAPPING THE SUPPLY CHAIN

There are three broad steps involved in the production of finished semiconductors: design, manufacturing, and ATP. The earliest semiconductor firms performed all three steps in-house and today are known as integrated device manufacturers (IDMs). IDMs continue to capture a majority of the semiconductor market

---

<sup>14</sup> Ziady, Hanna, "The global chip shortage is going from bad to worse. Here's why you should care." (CNN, May 4, 2021).

<sup>15</sup> Falan Yinug, "Chipmakers Are Ramping Up Production to Address Semiconductor Shortage. Here's Why that Takes Time", (Semiconductor Industry Association, February 26 2021).

<sup>16</sup> "Global auto recovery to take more hits from Japan chip plant fire, severe U.S. weather: HIS", (Reuters, March 31 2021).

<sup>17</sup> Stephanie Yang, "The Chip Shortage Is Bad. Taiwan's Drought Threatens to Make It Worse", (The Wall Street Journal, April 16 2021).

<sup>18</sup> NXP Press Release (<https://media.nxp.com/news-releases/news-release-details/nxp-resumes-operations-austin-texas-facilities-following-weather>)

<sup>19</sup> Dominick Reuter, "The ongoing chip shortage is expected to cost the auto industry \$110 billion this year, almost double analysts' estimate from January", (Business Insider, May 14 2021).

<sup>20</sup> Ziady, Hanna, "The global chip shortage is going from bad to worse. Here's why you should care." (CNN, May 4, 2021).

<sup>21</sup> Ziady, Hanna, "The global chip shortage is going from bad to worse. Here's why you should care." (CNN, May 4, 2021).

by revenue. Increasingly, though, each step is carried out separately, with different companies specializing in different steps of the process. In the fabless/foundry model, each of these three steps is performed by a different company that specializes in its role in the supply chain. In addition to these three fundamental steps, the semiconductor industry relies on sophisticated equipment and hundreds of materials used in the production process. Accordingly, this report examines the semiconductor supply chain through five related essential segments: (1) design; (2) fabrication; (3) ATP and advanced packaging; (4) materials; and (5) manufacturing equipment.

The semiconductor supply chain—from design to packaging to eventual incorporation into end products purchased by customers—is extremely complex and geographically dispersed. Due to the specialization of companies in specific steps, the typical semiconductor production process includes multiple countries, and the products may cross international borders 70 times.<sup>22</sup> The entire process takes up to 100 days, of which 12 days are for transit between supply chain steps. The figure below is a stylized representation of the supply chain.<sup>23</sup>



The small size and weight of semiconductors is a factor that enables such a geographically and logistically complex supply chain—the costs of transporting them is minimal compared with their value. However, it also implies that disruption of transportation routes could pose supply problems. Various forms of transport (e.g., airfreight, ocean freight, trucking) are used, depending on the stage and the distance to be travelled, as well as the nature of the product. In some cases, specialized handling is required, such as for hazardous and high-purity gases and chemicals used in the fabrication process, or to protect sensitive electronics from damage.<sup>24</sup>

## SEMICONDUCTOR DESIGN

### Semiconductor Design: Overview

The initial phase of semiconductor (chip) production—design—while historically carried out by IDMs (such as U.S.-based Intel and Texas Instruments) which control the entire production process, is increasingly carried out by more specialized “fabless” semiconductor design companies, which rely on a separate company to carry out the actual manufacturing of the semiconductor. The increased outsourcing of fabrication and the associated major capital investments has allowed for easier entry into the design stage of the process. This

<sup>22</sup> For chips going through the full Fabless, Foundry, and Packaging cycle; likely lower for IDMs.

<sup>23</sup> Nathan Associates, “Beyond Borders: The Global Semiconductor Value Chain”, (Semiconductor Industry Association, May 2016).

<sup>24</sup> “DHL Semiconductor Logistics”, (DHL, 2021).

results in significantly less industry concentration than in the fabrication and equipment stages, as well as a dependence on Taiwan for fabrication.

Despite lower barriers to entry, fabless design companies must coordinate closely with foundries to ensure the design fits the production process, and they are reliant on providers of IP—often other semiconductor companies which have developed key pieces of technology—and electronic design automation (EDA) software that enables the design process. These upstream and downstream stages are highly concentrated, with essential IP and EDA providers headquartered primarily in the United States—though with major portions of their workforce located outside the United States.

### *Industry Structure*

The structure of companies engaged in semiconductor design varies greatly depending on the types of semiconductors in question. The three primary types of integrated circuit semiconductors covered by this report—logic, memory, and analog—are reviewed here. For 2020, logic semiconductors were about 42 percent of the market,<sup>25</sup> memory about 26 percent,<sup>26</sup> analog about 14 percent, with the remainder of the market comprised of non-integrated-circuit semiconductors: discrete, optoelectronic, and sensor devices.

Logic chips, which are the building blocks of computing, comprise the largest category of semiconductors (according to the SIA, logic chips account for 42 percent of industry revenues).<sup>27</sup> In this category of semiconductors, market concentration and the number of design companies is highly dependent on the particular chip type. The markets for personal computer central processing units (CPUs), dedicated graphics processing units (GPUs), and field programmable gate arrays (FPGAs) are all essentially duopolies, while there is significantly more competition in the supplier base for application-specific integrated circuits (ASICs) and for mobile device processors based on ARM Ltd.'s (Arm) architecture. CPUs are the central processors for computers, GPUs are the processors for video rendering, FPGAs are designed to be configured by a customer or a designer after manufacturing, and ASICs are custom chips made for a particular use.

The United States is a world leader in semiconductor design, with many companies taking advantage of the lower capital expenditures enabled by outsourcing their manufacturing or locating their facilities outside of the United States. Essentially all personal computer CPUs are designed by U.S.-based companies Intel and AMD, though AMD relies on contract manufacturing.<sup>28</sup> These same companies may soon dominate the FPGA category, as AMD announced in October 2020 plans to acquire market leader Xilinx in a transaction valued at \$35 billion. Should the acquisition clear all regulatory hurdles, AMD-Xilinx and Intel would account for approximately 85 percent of global FPGA sales. Other U.S.-based suppliers Microchip Technology, Lattice Semiconductor, and Achronix Semiconductor constitute much of the remaining portion of the FPGA market. AMD also provides a major share of the world's dedicated GPUs, along with market leading U.S.-based NVIDIA.

---

<sup>25</sup> Varas et al. “Strengthening The Global Semiconductor Supply Chain In An Uncertain Era”

<sup>26</sup> Varas et al. “Strengthening The Global Semiconductor Supply Chain In An Uncertain Era”

<sup>27</sup> Varas et al. “Strengthening The Global Semiconductor Supply Chain In An Uncertain Era”

<sup>28</sup> Additionally, Apple's M-series processors, launched in late 2020, move Apple processors from Intel-based architecture to ARM-based architecture. These processors are designed by Apple and manufactured by TSMC.

Integrated Circuit Market Share Leaders, 2020						
Logic				Memory		Analog
PC CPU	Mobile CPU	GPU	FPGA	DRAM	NAND	
Intel - 78%	Qualcomm - 29%	NVIDIA - 82%	Xilinx - 52%	Samsung - 42%	Samsung - 33%	Texas Instruments - 19%
AMD - 22%	MediaTek - 26%	AMD - 18%	Intel - 36%	SK Hynix - 30%	Kioxia - 20%	Analog Devices - 10%
	HiSilicon - 16%		Microchip Technology - 7%	Micron - 23%	Western Digital - 14%	Infineon - 7%
	Samsung - 13%		Lattice - 5%		SK Hynix - 12%	Skyworks - 7%
	Apple - 13%				Micron - 11%	ST - 6%
					Intel - 9%	NXP - 5%

Based on data from Mercury Research, Counterpoint Research, Jon Peddie Research, Gartner, TrendForce, Mordor Intelligence, and IC Insights

There is significantly more competition in the ASICs supplier base with high demand for processors based on the ARM architecture for mobile devices. Chipmakers such as Samsung compete in the market for ASICs and mobile processors alongside fabless companies including U.S.-based Qualcomm and Broadcom as well as U.S. technology companies such as Apple, Alphabet, Amazon, and dozens of others that design some of their own chips. Apart from Intel and Microchip, most suppliers of CPUs, GPUs, FPGAs, and ASICs are fabless, relying on foundries for chip manufacturing.

Memory chips, which, according to SIA, account for 26 percent of industry revenues, are used for storing information needed for computing.<sup>29</sup> The memory category is commoditized and dependent on production volume and economies of scale, and memory is generally produced by IDMs. Korea-based Samsung and SK hynix lead the dynamic random-access memory (DRAM) segment along with U.S.-based Micron which holds about 23 percent of share. However, the market share leaders are developing advanced packaging technology (i.e., chip stacking) and other IP for leading edge products.<sup>30</sup> These three companies accounted for 95 percent of the \$70 billion global market in 2020.<sup>31</sup>

Flash memory (NAND) production is not quite as concentrated, with six companies accounting for an estimated 99 percent of the \$47 billion global market in 2020. Samsung is again a market leader, with slightly over one-third of the NAND market share, followed by Japan-based Kioxia (formerly Toshiba) (20 percent share), U.S.-based Western Digital (14 percent share), Korea-based SK hynix (12 percent share), U.S.-based Micron (11 percent share), and U.S.-based Intel (9 percent share).<sup>32</sup> The NAND segment appears poised for further consolidation, as Intel—with NAND revenue similar to that of Micron—announced in October 2020 that it plans to sell most of its NAND memory business to SK hynix. This sale would propel the combined company into the second place in NAND market share. There are also reports suggesting Western Digital and Micron may be pursuing an acquisition of Kioxia.<sup>33</sup> In addition, China-based Yangtze Memory Technologies (YMTC), formed in 2016, is focused on rapid expansion and has received an estimated \$24 billion in subsidies from Chinese government sources. The company may have the capacity to produce as

<sup>29</sup> Varas et al. “Strengthening The Global Semiconductor Supply Chain In An Uncertain Era”

<sup>30</sup> See section on “Advanced Packaging”.

<sup>31</sup> Avril Wu, “DRAM Revenue for 4Q20 Undergoes Modest 1.1% Increase QoQ in Light of Continued Rising Shipment and Falling Prices, Says TrendForce”, (TrendForce, March 4 2021).

<sup>32</sup> “NAND Flash Memory Market – Growth, Trends, COVID-19 Impact, and Forecasts (2021-2026)”, (Mordor Intelligence, n.d.).

<sup>33</sup> “SK hynix to Acquire Intel NAND Memory Business”, (Intel, October 19 2020); Jacky Wong, “Kioxia Is a Must-Have for Both Western Digital and Micron”, (The Wall Street Journal, April 1 2021).

many as 200,000 wafers per month by 2022, over twice Intel's current NAND production capacity, representing a potential low-cost threat to U.S.-based memory companies.<sup>34</sup>

Compared to memory chips, analog integrated circuit chips are less commoditized and are generally less reliant on using cutting edge manufacturing nodes. Specialized experience with the systems and end uses are a significant driver of value in analog chip production, allowing for less market concentration as companies can retain competitive advantages by specializing within the analog sector. The 10 largest analog integrated circuit suppliers accounted for 62 percent of the \$56 billion market in 2020, with only Texas Instruments exceeding 10 percent market share.<sup>35</sup> Many of the leading analog semiconductor companies operate as "fab-lite" producers, manufacturing some of the chips they design but outsourcing a significant portion as well.

Discrete, optoelectronic and sensors, the non-integrated circuit semiconductors, comprised \$79 billion in sales in 2020, nearly 18 percent of the total semiconductor market (\$440 billion).<sup>36</sup> Most of the semiconductors in this category are mature node technology chips, often only worth pennies each. This market is highly fragmented, with numerous manufacturers. Non-integrated circuit semiconductors include ABB Ltd., (Sweden/Switzerland), Infineon Technologies (Germany), STM Microelectronics (Italy/France), Toshiba (Japan), and U.S. companies Diodes Inc., Vishay Intertechnology, Qorvo, dPix, and Cree. Key driving technologies (and exceptions to mature node technology) for non-integrated semiconductors are innovations in power management and miniaturization, especially for discrete power semiconductors, with autos, especially electronic vehicles as a key end-use.<sup>37</sup> The U.S.-led R&D of gallium nitride (GaN), silicon carbide (SiC) and other compound semiconductor substrates is a key development for a variety of applications, including those for national security in power management and distribution, high-frequency power amplification, and optoelectronics (also exceptions to mature node technology). Flat panel display semiconductors are also in this category.

### *Process Steps*

The semiconductor design process itself contains several steps, often performed iteratively to reach a final design that best meets the end requirements. Basic process steps include specification, system level or architecture design, logic design, physical design, and verification/validation. These stages are briefly reviewed below.

- Specification: This step lays out the set of requirements for the chip necessary to fulfill its end uses. This involves translating user requirements to the chip's performance, meaning that having a deep understanding of the customer's needs provides an advantage to the designer. Proximity and access to the customers can thus be meaningful to semiconductor design operation.
- System level design: This step involves breaking out the basic semiconductor architecture. In many cases, the design can be created using pre-defined inputs that have already been specified and validated, either from past use within the company or licensed from another company. Known simply as IP or IP cores, the re-use of past designs in modular form allows for faster development of new features and decreased costs because the IP does not have to be re-developed for every new chip.
- Logic design and physical design: These steps are typically carried out using EDA software, which maps the register transfer level code to physical representations of the electronic components that will be manufactured on the chip.
- Verification and validation: This step, which is carried iteratively and in parallel to other design steps, involves testing the design. At this stage, the design is simulated via a "test bench," which is a virtual

---

<sup>34</sup> Alan Patterson, "China's YMTC is Poised to Lead in NAND Flash Technology", (EET Asia, November 11 2020).

<sup>35</sup> "Texas Instruments Remains World's Top Analog IC Supplier", (EPSNews, March 29 2020).

<sup>36</sup> "The Worldwide Semiconductor Market was up 6.8 percent in 2020, and is expected to show a double digit growth of 10.9 percent in 2021", (World Semiconductor Trade Statistics, March 17 2021).

<sup>37</sup> "Global Discrete Semiconductor Market - Growth, Trends, Covid-19 Impact, And Forecasts (2021 - 2026)", (Mordor Intelligence, 2020).

model of the chip and ensures it operates as expected. Verification can generate massive amounts of test data and take significant amounts of time, accounting for as much as half of the time to design a chip.<sup>38</sup>

For national security, the semiconductor technologies must also be qualified for use over the military temperature ranges (extended range) and harsh environments, including technology characterization for use in radiation environments when appropriate. Also, a more stringent and independent parts verification and validation is required. Semiconductors for automotive applications must likewise meet stringent durability and testing requirements to withstand harsh environmental conditions (e.g., extreme cold, heat and humidity). They must handle exposure to vibrations and shocks throughout the vehicle's entire expected lifespan of 10 to 20 years and exhibit a much lower failure rate in testing than semiconductors for consumer product applications to ensure they meet vehicle safety requirements. These requirements are expected to increase and be more stringent as vehicles become more autonomous and incorporate an increasing amount of light detection and ranging (LiDAR), sonar, radar, vision systems, and navigation and recognition technologies.

### **Semiconductor Design: Resilience**

#### *Resilience: Intellectual Property*

As noted above, the re-use of past designs—known as IP, IP cores, or IP blocks—from either within the design organization or licensed from another company—is a major factor enabling the rapid development of new chips. Representing an estimated \$5 billion market, these IP blocks represent designs for anything from minor internal processes to input/output interfaces such as Universal Serial Bus (USB) and Ethernet controllers, to full microprocessor instruction set architectures (ISAs).<sup>39</sup> IP is typically licensed for an up-front fee, but may also include sales-based royalties.

Recent years have seen increased market share in IP licensing from EDA providers as they expand to provide more complete design solutions and integration of IP cores into design software. In this context, the IP that is licensed includes patents, trademarks, industrial designs, copyrights, and trade secrets. In addition to ongoing growth in leading EDA providers U.S.-based Synopsys and Cadence as well as U.S.-based but German-owned Mentor Graphics, Samsung announced in May 2019 that it would license its semiconductor design IP through EDA provider Silvaco, boosting the U.S.-based company's integrated design offerings. This move highlights the value to foundries in enabling chip designers to design for their processes; with built-in foundry IP in the design, the cost of changing manufacturers serves to lock-in design customers.

The IP core sector historically has been led by companies headquartered in the United States and United Kingdom, with Arm Ltd. (U.K.) topping the list, along with EDA providers Synopsys and Cadence.<sup>40</sup> While headquartered in the United States and U.K., these companies have global workforces; over two-thirds of the employees of Synopsys, for example, were located outside of the United States in 2020.<sup>41</sup> Arm provides the IP that supports most of the world's mobile device processors, with hundreds of licensees representing over

---

<sup>38</sup> Aaron Aboagye, Mark Patel, and Nitin Vig. “Standing up to the semiconductor verification challenge”, (McKinsey, Autumn 2014).

<sup>39</sup> Jim Turley, “IP Market Large, Growing, and Strange Apart from One Big Winner, Fortunes are Decidedly Mixed”, (Electronic Engineering, September 25 2019).

<sup>40</sup> An additional area is the ongoing development of the RISC-V open standard ISA, which provides IP open source and license-free, is a relatively new phenomenon in the microprocessor IP licensing area. Initially developed at the University of California, Berkeley in 2010 with funding from Intel, Microsoft and others, the RISC-V IP is owned and maintained by the non-profit RISC-V Foundation, founded in the United States in 2015. In December 2018, the foundation announced intentions to re-incorporate in Switzerland, in part to “alleviate uncertainty” surrounding export restrictions from the United States and the goal of “calming concerns of political disruption to the open collaboration model.” To date, RISC-V IP has not made significant inroads on the microprocessor-enabling ISA space dominated by Intel and Arm. As the RISC-V Foundation states, it does not represent “a great new chip technology,” but rather is attractive to many because it is a common and open standard. See: “History of RISC-V”, (RISC-V, 2021).

<sup>41</sup> Synopsys Inc, “Form 10-K”, (U.S. Securities and Exchange Commission, October 31 2020).

150 billion chips sold.<sup>42</sup> Arm, which does not produce semiconductors and is currently owned by Japan-based Softbank, is in the process of being acquired by U.S.-based fabless design firm NVIDIA, raising concerns among competing semiconductor designers as well as investigations by several governments' antitrust regulators over continued access to essential IP.<sup>43</sup> In addition, in April 2021, the U.K. government initiated a national-security review of the proposed acquisition.<sup>44</sup>

Over the past several years, China has taken steps to increase its access to and control of semiconductor IP. In 2017, Canyon Bridge Capital Partners, a private equity fund with Chinese government ownership, purchased U.K.-based Imagination Technologies, estimated to be the fifth largest provider of semiconductor IP. In 2018, Arm China was formed as a 51 percent Chinese-owned joint venture with U.K.-based Arm Holdings.<sup>45</sup> Greater Chinese control over semiconductor IP may present a risk to U.S. industry by limiting the IP available to U.S. companies.

### *Resilience: Electronic Design Automation*

The use of EDA software that automates the layout of circuits in an electronic representation has become a critical input to the semiconductor design process as chips contain billions of transistors. The market for EDA tools historically represents about two percent of the overall semiconductor market, but has taken on increasing importance as shrinking semiconductor technology nodes drive design costs higher.<sup>46</sup> EDA provider Synopsys, for instance, estimated in 2019 that the cost to design a 5 nanometer (nm) chip would be twice that to design a 7 nm chip.<sup>47</sup> According to IBS, the cost of designing a 7 nm chip is \$297.8 million while that for a 5 nm chip is \$542.2 million.<sup>48</sup>

Since the mid-1990s, the EDA market has been dominated by three U.S.-based companies: Synopsys, Cadence, and Mentor Graphics (purchased by Germany-based Siemens in 2017). This dominance stems at least in part from a combination of the market leaders' ability to purchase and incorporate smaller EDA providers, the high costs to designers of switching EDA providers, and EDA companies' relationships with foundries, which often provide preferential access to process-specific design "kits" for new manufacturing processes in order to enable the EDA vendor to develop process-specific design flows. This level of integration highlights the importance of access to IP for semiconductor producers.

As the use of integrated circuit chips has become more ubiquitous and the value to end users of specially-designed chips has grown, EDA tools have enabled a broadening set of companies to enter the semiconductor design space, such as users of semiconductors called "systems" companies, including Apple, Alphabet (the parent company of Google), and Amazon. These companies are empowered by the research, development, and IP incorporated into EDA tools to design chips that best meet their specific requirements. The growing importance of chip design to downstream technology "systems" companies is reflected in industrial process giant Siemens' purchase of Mentor Graphics in 2017. The increased use of microelectronics throughout semiconductor end users' systems and the resulting increase in system design complexity provide avenues to expand the use of EDA to produce improved integration between semiconductors and end use systems.

---

<sup>42</sup> Dean Takahashi, "Simon Segars interview — Arm's CEO on competitive threats, custom instructions, and a far-off IPO", (VentureBeat, October 14 2019).

<sup>43</sup> David McLaughlin, Ian King, and Dina Bass, "Google, Microsoft, Qualcomm Protest Nvidia's Acquisition of Arm Ltd", (Bloomberg, February 12 2021).

<sup>44</sup> Stu Woo and Eric Sylvers, "Nvidia's \$40 Billion Deal for Arm Faces U.K. National-Security Probe", (The Wall Street Journal, April 19 2021).

<sup>45</sup> "Establishment of Joint Venture for China Business at Subsidiary Arm", (SoftBank Group, June 5 2018).

<sup>46</sup> Wally Rhines, "Chapter 7 – Competitive Dynamics in the Electronic Design Automation Industry", (SemiWiki.com, August 23 2019).

<sup>47</sup> "Synopsys Investor Day", (Synopsys, April 2 2019).

<sup>48</sup> Mark Lapedus, "Big Trouble at 3nm", (Semiconductor Engineering, June 21 2018).



## *Resilience: Workforce*

The U.S. semiconductor supply chain is heavily dependent on a high-skilled workforce. The size of the design-specific workforce is difficult to gauge, as design is carried out by IDMs such as Intel, by fabless semiconductor companies such as NVIDIA (which reports 7,500 U.S.-based employees), and by companies that are not strictly part of the semiconductor industry, such as Alphabet, Cisco, and Tesla. The EDA sector upon which design companies rely employs tens of thousands of additional workers; Synopsys alone employs more than 5,000 workers in the Americas, 80 percent of whom are engineers.<sup>49</sup> Further, the entire industry is supported by R&D carried out at universities across the United States with thousands of researchers contributing, and an estimated 250,000 students enrolled in semiconductor-related graduate programs.<sup>50</sup>

The ability of the United States to attract and retain talented workers to American universities and companies underpins the long-term competitiveness of the U.S. semiconductor industry. Since 1990, the number of American students enrolled in semiconductor related graduate programs has remained the same while that for international students has tripled over the same period. According to data from 2016-2017, about two-thirds of graduate students in electrical engineering and computer science are international students.<sup>51</sup>

### **Semiconductor Design: Risks**

The key design-specific risks are reviewed briefly below. Because semiconductor design affects every subsequent step in the manufacturing process, the risks reviewed below are largely applicable to the downstream process steps as well.

- **Need for High R&D Expenditures:** U.S. design companies typically invest major portions of their revenue in R&D; six of the seven leading companies in R&D intensity in 2019 were U.S.-based.<sup>52</sup> As design costs at the cutting edge continue to rise, the ability of design companies to continue to invest is dependent on sales growth, which has grown increasingly dependent on sales outside the U.S. and in China in particular.
- **Skilled Workers:** With international students making up an increasing majority of enrollment in U.S. semiconductor-related graduate programs, limits to the ability of foreign-born workers to remain and work in the United States and continued low levels of enrollment of U.S.-born workers present ongoing and long-term risks. In addition, although U.S. universities are consistently graduating more engineering and computer science students each year, the industry faces significant challenges in recruiting and retaining these graduates. Students in related programs are often more conversant in and drawn to software development opportunities than hardware. Companies serving defense needs face additional challenges in that they are unable to compete with the compensation packages common in commercial industry.
- **Access to Foundries:** Semiconductor design companies are enabled by EDA and IP companies, which in turn are enabled by access to and cooperation with fabrication facilities and downstream systems. As systems become increasingly connected and complex, cooperation between companies and access across the levels of the supply chain will continue to rise in importance. The increasing concentration of foundries in East Asia (discussed in the “fabrication” segment below) and the resulting potential for decreased access to and cooperation with manufacturers presents a risk to the continued ability of U.S. semiconductor design companies to lead the world in innovation.

In summary, the U.S. semiconductor design ecosystem is robust and world-leading, but depends on limited sources of IP, labor, and manufacturing that are essential to bring products to market. The needed IP cores

---

<sup>49</sup> Synopsys Inc, “Form 10-K”

<sup>50</sup> Will Hunt and Remco Zwetsloot, “The Chipmakers: U.S. Strengths and Priorities for the High-End Semiconductor Workforce”, (Center for Security and Emerging Technology, September 2020).

<sup>51</sup> Will Hunt and Remco Zwetsloot, “The Chipmakers: U.S. Strengths and Priorities for the High-End Semiconductor Workforce”

<sup>52</sup> Stephen Ezell, “Moore’s Law Under Attack: The Impact of China’s Policies on Global Semiconductor Innovation”, (Information Technology & Innovation Foundation, February 18 2021).

and EDA tools are available from U.S.-based companies, but these sectors are highly concentrated. The United States remains an attractive place for skilled engineers and other highly skilled workers, but the semiconductor design sector faces a shortage of skilled workers and is increasingly dependent on foreign-born labor as well as design teams based outside the United States. Restrictions on the ability of U.S. companies to recruit foreign-born workers or in universities to attract foreign-born students could have long-term impacts on the U.S. semiconductor design sector, as would a failure to increase the relevant educational and training opportunities for U.S.-born students. Furthermore, the U.S. fabless design sector is dependent on contract foundries, which are primarily located in East Asia, to manufacture their products and on sales to customers outside of the United States, particularly in China.

## **SEMICONDUCTOR FABRICATION**

### **Semiconductor Fabrication: Overview**

This section addresses the next step in the supply chain in which semiconductor designs are fabricated into component part types, such as logic, memory, or analog devices. During this process, semiconductor fabrication facilities (fabs) or foundries (also called pure-play foundries), make disc-shaped wafers (typically cut from an ingot of silicon) into individual chips (each the size of a fingernail). This is a complex and highly specialized capability that requires exact precision—there is no room for error in the processing steps of wafer fabrication. A semiconductor manufacturing plant involves thousands of process machines, lasers, ultra-precision optics, and advanced robotics. The fabrication process is one of the most advanced in the world, involving cutting-edge techniques and equipment, operating at subatomic-level precision. This stage of the semiconductor supply chain accounts for about 24 percent of the value added to the chip.<sup>53</sup>

#### *Industry Structure*

There are two basic industry models for fabs. The first are fabs operated by vertically integrated semiconductor companies or IDMs that perform all of the steps in the semiconductor manufacturing process—from design to final testing. IDMs account for about two-thirds of global semiconductor production capacity.<sup>54</sup> The majority of IDMs produce memory chips such as DRAMs, as well as discrete analog devices, although Intel, a leading U.S.-based IDM, produces primarily logic devices. In addition to Intel, the United States has several leading IDMs, including Analog Devices, Maxim Integrated Products, Microchip Technology, Micron, ON Semiconductor, and Texas Instruments. It is important to note that, while headquartered in the United States, these companies undertake semiconductor manufacturing in facilities across the world. Intel, for example, operates fabs in Israel, Ireland, and China in addition to the United States, while South Korean-based Samsung and other foreign-headquartered firms produce chips in the United States in addition to their international facilities. SIA reports that 44 percent of U.S.-based semiconductor companies' production capacity is located in the United States.<sup>55</sup> Overall, U.S.-based IDMs accounted for 51 percent of global IDM revenues in 2020, and the United States is especially strong in logic and analog chips.

Many U.S. leaders in semiconductors, such as AMD, Broadcom, NVIDIA, Qualcomm, and Xilinx, operate with a "fabless" business model, in which companies provide their designs to a separate company that specializes in contract manufacturing of semiconductors. These third-party foundries are categorized as "pure-play semiconductor foundries" because they do not design or sell any chips of their own, but act as contract manufacturers for fabless semiconductor firms (and sometimes provide additional capacity or otherwise produce certain chips for IDMs). Some IDMs, notably Samsung, also provide foundry services for fabless companies.

The fabless/foundry business model has become increasingly prevalent as the costs of building and maintaining a state-of-the-art semiconductor manufacturing facility has skyrocketed. Continued advances in

---

<sup>53</sup> Varas et al. "Strengthening The Global Semiconductor Supply Chain In An Uncertain Era"

<sup>54</sup> "Supply Chain Briefing to the U.S. Department of Commerce"

<sup>55</sup> "2020 State of The U.S. Semiconductor Industry", (Semiconductor Industry Association, 2020).

chip-making technology require entirely new, increasingly costly fabrication equipment. The cost of a state-of-the-art fab (at the 5 nm process node) is at least \$12 billion.<sup>56</sup> One extreme ultraviolet (EUV) lithography tool (necessary for manufacturing at or below 5 nm and also often used at 7 nm) alone can cost in the range of \$150 million, and many types of equipment are needed in a single fab. One estimate is that the investment that will be required for the next generation fab (that will operate at the 3 nm node) might exceed \$20 billion.<sup>57</sup> Moreover, once a new fab is established, operational costs are significant, and ongoing expensive capital investment is required to keep operating at state-of-the-art production nodes. Pure-play foundries benefit from economies of scale, which allow them to absorb the enormous costs of maintaining a semiconductor plant at the cutting edge of technology demanded by chip designers at efficient capacity utilization rates. According to SIA, pure-play foundries account for about one third of global chip production capacity, but nearly 80 percent of production capacity for logic chips.<sup>58</sup> Taiwan Semiconductor Manufacturing Company (TSMC) was the world's first pure-play semiconductor foundry, founded in 1987, and dominates the market today.

The contract foundry market is dominated by Taiwan-based companies, with TSMC alone accounting for 53 percent of the market share of the foundry market. In total, Taiwan-based companies account for 63 percent of the market share. South Korea has 18 percent and China six percent. U.S.-headquartered, Abu Dhabi-owned foundry GlobalFoundries has seven percent share, making up more than half of the remaining 13 percent share of the foundry market.<sup>59</sup>

While the U.S. share of IDM chip market is significant, it has only a 10 percent share of global foundry revenue; foundries in Asia account for an 80 percent share.<sup>60</sup> Taiwan alone accounted for 73 percent of global foundry business.<sup>61</sup> This means that, as noted above, while the U.S. is a leader in semiconductor design, domestic fabless firms are heavily dependent on foreign firms, mainly in Asia, for manufacturing. While this foundry business model is suited to high volume commercial applications, many defense-related applications are low volume, making access to advanced semiconductor manufacturing technologies challenging.

### *Process Steps*

The diagram below is a simplified representation of the complex semiconductor fabrication process. Starting with a set of photomasks imprinted with the chip design, and a prepared clean wafer, chip fabrication steps are performed. The steps include:

- lithography (a process used to create circuit patterns of the wafer);
- etching (removing materials from the wafer);
- doping (adding elemental impurities to modulate the electrical properties of the wafer);
- deposition (process for creating layers of insulating and conducting materials used to build a semiconductor device); and
- polishing or chemical mechanical planarization (a process for removing excess materials and creating a smooth surface on each layer).

The wafer will go through these processes multiple times; the entire process is automated and takes place in a sealed clean room. Fabrication of an advanced semiconductor device (at the 10 nm or below node) can take up to 15 weeks, with 11-13 weeks being the industry average. After the front-end processes in which the

---

<sup>56</sup> Willy Shih, "TSMC's Announcement of A New U.S. Semiconductor Fab Is Big News", (Forbes, May 15 2020).

<sup>57</sup> Matt Hamblen, "TSMC starts building 3nm plant in Taiwan worth \$20B", (Fierce Electronics, November 4 2019).

<sup>58</sup> "Supply Chain Briefing to the U.S. Department of Commerce"

<sup>59</sup> "Foundry Revenue Projected to Reach Historical High of US\$94.6 Billion in 2021 Thanks to High 5G/HPC/End-Device Demand, Says TrendForce", (TrendForce, April 15 2021).

<sup>60</sup> "2020 State of The U.S. Semiconductor Industry"

<sup>61</sup> "Semiconductors: U.S. Industry, Global Competition, and Federal Policy", (Congressional Research Service, October 26 2020).

design is transferred onto the wafer, the wafer is tested, polished, and diced into individual chips. The number of chips yielded varies; a 300 mm wafer might produce 600 or more individual chips.

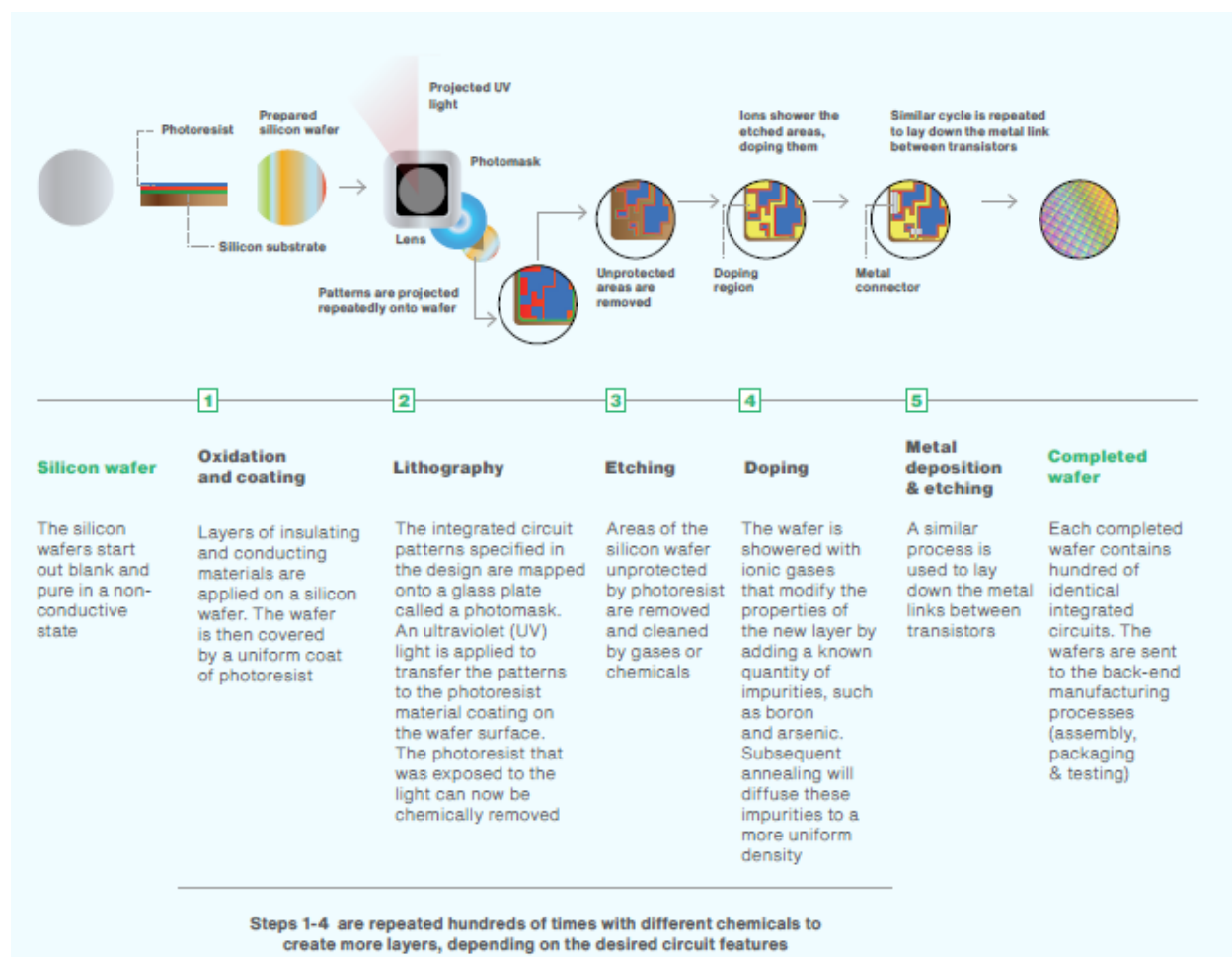

Source: SIA<sup>62</sup>

Semiconductor fabrication facilities require a substantial acreage and utility infrastructure – including access to ultrapure gases, dry air and nitrogen, ultrapure water, exhaust systems, and high-quality reliable electrical power. A large wafer fab can consume as much as 100 megawatts of power, making it more energy intensive than many automotive plants and oil refineries, and can use as much water as a small city. The water used in the fab undergoes an energy-intensive purification process in which all organic and inorganic contaminants are removed. The filtering and treatment process uses pumps, motors, drives and other infrastructure that moves the ultrapure water in and around the facility and wastewater out. Power outages and voltage irregularities can damage highly sensitive equipment, so reliability of the power supply is critical. Electricity can account for up to 30 percent of a wafer fab's operating costs. Savings through improved energy efficiency can help cut costs while reducing environmental impacts and improving sustainability.<sup>63</sup>

### Semiconductor Fabrication: Current Resilience

The vast majority of semiconductor manufacturing – by IDMs and pure-play foundries – takes place in (in order): Taiwan, South Korea, Japan, China, and the United States. U.S.-installed semiconductor production

<sup>62</sup> SIA, [https://www.semiconductors.org/wp-content/uploads/2021/04/SIA-BCG-Report\\_Strengthening-the-Global-Semiconductor-Supply-Chain\\_April-2021.pdf](https://www.semiconductors.org/wp-content/uploads/2021/04/SIA-BCG-Report_Strengthening-the-Global-Semiconductor-Supply-Chain_April-2021.pdf) (last accessed May 26, 2021).

<sup>63</sup> “Innovative Power Solutions for Semiconductor Fabrication Efficiency”, (SchneiderElectric, 2018).

capacity<sup>64</sup> accounts for approximately 12 percent of the global total, down from 37 percent in 1990.<sup>65</sup> In 2019, Taiwan accounted for 20 percent of global installed capacity, followed closely by South Korea with 19 percent. Japan accounted for 17 percent, China for 16 percent of capacity; and Europe nine percent. The remaining six percent of capacity is in Singapore, Israel, and the rest of the world.<sup>66</sup>

**U.S. Semiconductor Manufacturing Capacity as a Percent of Global Capacity**

**1990-2021 and 2030 Forecast**

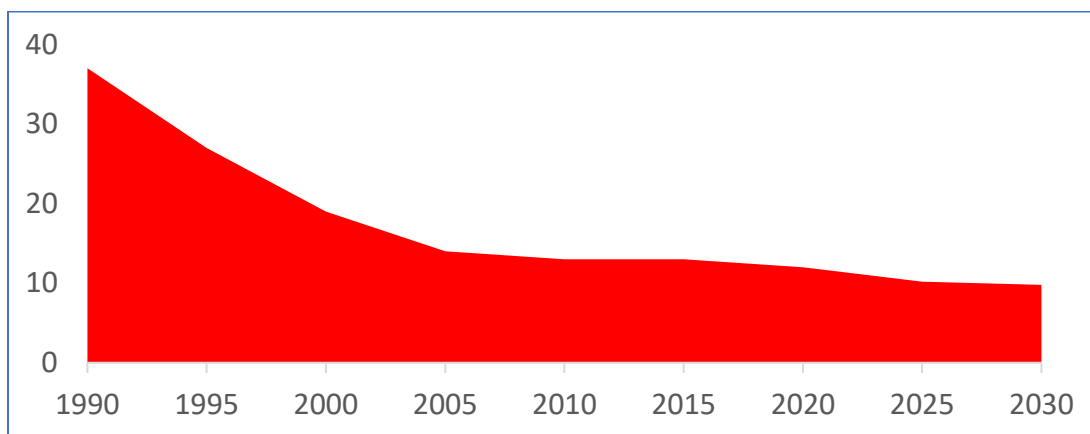

Source: SEMI, VLSI and BCG<sup>67</sup>

Of the 40 major semiconductor fabs located in the United States, half (20) produce using 300 mm (12 inch) wafers, which is the modern standard; the others produce using 200 mm (8 inch) wafers or below. Between 2009 and 2018, more than one hundred 150-200 mm fabs closed worldwide with 70 percent of the closure locations in the United States and Japan. According to IC Insights, many<sup>68</sup> of the fabs had been used for decades and had outlived their useful purpose. In some cases, they were replaced by more cost efficient or upgraded facilities. In other cases, the cost of fab ownership was too great, and the company moved to fab-lite or fabless business model.<sup>69</sup>

Six companies operate the twenty 300 mm fabs, and are located in eight U.S. states, as detailed in the following table. All but Skorprios also operate fabs overseas. As noted above, Intel has semiconductor production operations in Israel, Ireland, and China. Micron has fabs in Singapore, Japan, and Taiwan in addition to its U.S. facilities, while Texas Instruments has production in China, Malaysia, Taiwan, and the Philippines in addition to Texas. GlobalFoundries, the leading U.S. pure-play foundry, is owned by the Emirate of Abu Dhabi via sovereign wealth fund Mubadala and also has fabs in Germany and Singapore. In 2019, the company scrapped plans to open a fab in Chengdu, China.

<b>Company</b>	<b># of Fabs</b>	<b>Location</b>	<b>Products</b>
GlobalFoundries	2	Malta, NY	Foundry

<sup>64</sup> Maximum output that can be produced, see: Varas et al. “Strengthening The Global Semiconductor Supply Chain In An Uncertain Era”

<sup>65</sup> Varas et al. “Strengthening The Global Semiconductor Supply Chain In An Uncertain Era”

<sup>66</sup> Varas et al. “Strengthening The Global Semiconductor Supply Chain In An Uncertain Era”

<sup>67</sup> Varas et al. “Government Incentives and U.S. Competitiveness in Semiconductor Manufacturing”, (Boston Consulting Group and Semiconductor Industry Association, September 2020).

<sup>68</sup> “100 IC Wafer Fabs Closed or Repurposed Since 2009”, (IC Insights, March 26 2020).

<sup>69</sup> “100 IC Wafer Fabs Closed or Repurposed Since 2009”, (IC Insights, March 26 2020).

<b>Company</b>	<b># of Fabs</b>	<b>Location</b>	<b>Products</b>
GlobalFoundries	1	East Fishkill, NY <sup>70</sup>	Foundry
Intel	2	Chandler, AZ	IDM/Logic
Intel	4	Hillsboro, OR	IDM/Logic
Intel	2	Albuquerque, NM	IDM/Logic
Micron	1	Boise, ID	R&D/Pilot
Micron	1	Lehi, UT	IDM/Memory
Micron	2	Manassas, VA	IDM/DRAM
Samsung	2	Austin, TX	IDM/Foundry
Skorpios	1	Austin, TX	Pilot Fab
Texas Instruments	1	Richardson, TX	IDM/Analog
Texas Instruments	1	Dallas, TX	IDM/Analog

Source: Congressional Research Service.<sup>71</sup>

While U.S. chip production capacity has been relatively stable, capacity and production are growing outside of the United States, particularly in Asia. As a result, SIA predicts that, by 2030, the U.S. share of semiconductor production capacity will fall to 10 percent, while the Asian share will grow to 83 percent. In 2019, of six new semiconductor production facilities in the world, none were in the United States, while four were in China.

As noted in the discussion of the "design" segment, this report covers three primary types of chips: memory, logic, and analog. As can be seen in the diagram below, different regions of the world specialize in different sectors. For example, the United States produces only five percent of memory chips, while South Korea accounts for 44 percent, and China 14 percent.<sup>72</sup> In the memory segment, as noted above, China has focused on rapid expansion of YMTC, providing the company with \$24 billion in subsidies allocated just for its Wuhan factory.<sup>73</sup> The company's expansion and low-price offerings presents a direct threat to U.S. memory chip makers Micron and Western Digital.

In the logic chip segment (e.g., computer and cell phone microprocessors), the United States produces none of the leading edge (under 10 nm) chips while Taiwan accounts for 92 percent. At other logic chip nodes, the United States is stronger: it produces 43 percent of advanced (10-22 nm) logic chips, and the six to nine percent of prior generation (28 nm and above) logic chips while Taiwan between 31 and 47 percent and China between 19 and 23 percent. Finally, the United States produces 19 percent of analog/discrete chips while China 17 percent and South Korea 27 percent.<sup>74</sup>

<sup>70</sup> This facility has been acquired by ON Semiconductor for \$430 million; ON Semiconductor will gain full operational control of the East Fishkill fab at the end of 2022.

<sup>71</sup> Congressional Research Service. "Semiconductors: U.S. Industry, Global Competition, and Federal Policy". October 26 2020, p.22 <https://crsreports.congress.gov/product/pdf/R/R46581> (last accessed May 26, 2021).

<sup>72</sup> Varas et al. "Strengthening The Global Semiconductor Supply Chain In An Uncertain Era".

<sup>73</sup> Stephen Ezell, "Moore's Law Under Attack: The Impact of China's Policies on Global Semiconductor Innovation"

<sup>74</sup> Varas et al. "Strengthening The Global Semiconductor Supply Chain In An Uncertain Era"

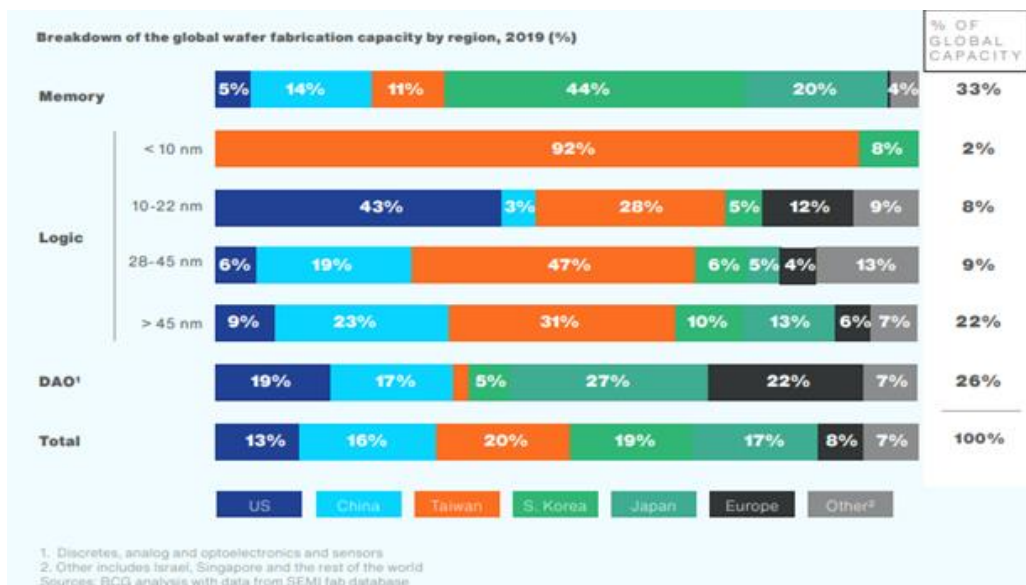

## Semiconductor Fabrication: Risks

The key fabrication-specific risks are reviewed briefly below.

- Lack of U.S. Production Capability at the Most Advanced Technology Levels:** The United States lacks semiconductor production capability at the most advanced semiconductor process node—currently 5 nm—at which only TSMC (Taiwan) and Samsung (South Korea) currently operate. The most advanced fabs in the United States are 10 nm<sup>75</sup> operated by Intel, which does not expect to enter full 7 nm production until 2023 and announced in January 2021 that it will be using TSMC’s “enhanced” 7 nm or less production line for its latest graphics chip.<sup>76</sup> As a result, U.S. fabless chip companies now rely almost exclusively on Asian producers (especially TSMC) for production of the most advanced (7 nm or less) chips. These are used in emerging industries, such as electrification, 5G, and Internet of things (IoT). Much of TSMC’s 5 nm (and in the future, 3 nm) production will be devoted to meeting the needs of companies such as Apple for utilization in mobile communications devices. In addition to supply chain risks due to the geographic concentration of production, the lack of domestic capability at the most advanced technology also raises concerns for national security, as secure access to state-of-the-art technology is needed to provide technical superiority for some military applications.
- Dependence on Geographically Concentrated Foreign Production for Mature Chips:** In addition to foreign reliance for leading edge chips, as reviewed above, the United States relies on sources concentrated in Taiwan, South Korea, and China to meet demand for various non-leading edge memory and logic chips that are used widely in myriad consumer and industrial applications. This impacts the U.S.’s ability to supply various sectors critical to its current and future national security and critical infrastructure needs. Trailing edge logic chips are used in many military and critical infrastructure applications, which can have significantly longer lifespans than consumer applications.
- Dependence on China for Sales Revenue:** Due to China’s dominance in the electronics assembly space, U.S. chipmakers are also heavily dependent on sales to China. China is the largest market for semiconductors, most of which are then re-exported when contained in end products, including consumer electronics and appliances. According to The Economist in 2018, for example, mobile phone chip provider Qualcomm generated two-thirds of its revenue from China, and memory maker Micron

<sup>75</sup> Some experts indicate that Intel’s 10 nm process is roughly equivalent to TSMC and Samsung’s 7 nm process; Daniel Nenni, “SEMICON West Intel 10nm and GF 7nm Update”, (SemiWiki.com, July 18 2018).

<sup>76</sup> “Intel plans to tap TSMC’s 7 nanometer process for ‘DG2’ graphics chip”, (DeccanHerald, January 12 2021).

generated 57 percent of its revenue from the country.<sup>77</sup> Intel reported in 2020 that China accounted for 26 percent of its revenue. Heavy reliance on sales to China provides the Chinese Government with economic leverage and the potential to retaliate against the United States.

- **China’s Aspirations to Lead the Semiconductor Industry:** China’s share of the global semiconductor industry is relatively small and its companies produce mostly low-end chips. China’s most advanced pure-play foundry, Semiconductor Manufacturing International Corporation (SMIC), can only produce at the 14 nm node, with limited capacity. However, the country is in the middle of major state-led effort to develop an indigenous, vertically integrated industry that leads in all segments by 2030. China’s share of semiconductor wafer capacity stood at 16 percent in 2019, but is expected to grow to 28 percent by 2030. The Chinese Government is devoting \$100 billion in subsidies to its semiconductor industry, including the development of 60 new manufacturing facilities.<sup>78</sup> As discussed in the discussion of “design” segment of the supply chain, China has moved aggressively with its subsidies to develop a home-grown memory chip maker to break its reliance on the world’s three main memory companies: Samsung (South Korea), SK hynix (South Korea), and Micron (U.S.). U.S. memory firm Micron is a direct competitor with YMTC and will likely be the first U.S. firm to see its future competitiveness and ability to innovate threatened as a result of Chinese subsidies funding its competitor.
- **Workforce Challenges:** The domestic semiconductor industry has experienced a “greying” of its workforce, coupled with difficulties in attracting and retaining younger workers with the necessary skills (for whom the semiconductor industry competes with other technology companies). Workers in fabs, such as factory technicians and line workers, account for about 38 percent of the domestic semiconductor workforce. These workers maintain and operate complex manufacturing equipment; the positions typically require at least an associate’s degree or skill-specific hands-on training.<sup>79</sup>
- **Rising Fab Costs:** As semiconductor technologies advance, the cost of building a next generation fab increases significantly. As noted above, the cost of a fab at the 5 nm node is approximately \$12 billion while that for a fab at the 3 nm node may exceed \$20 billion. In order to justify the initial and ongoing investment for a fab, the average fab utilization is 80 percent.<sup>80</sup> This is one reason that the small and medium sized semiconductor companies are mostly fabless, concentrating on the design and IP for semiconductors without having to maintain an ongoing fab business.
- **Unique Challenges of Developing New Manufacturing Knowledge:** Production IP, the manufacturing know-how that is created in the process of translating knowledge into products, is the critical link between R&D and all downstream economic benefits. A manufacturer that invests in developing production process IP only captures the benefits associated with that IP and the portion of the relevant market that they capture. The comparatively massive benefits associated with the IP and the rest of the market are generally lost forever. In some cases, that same IP gets re-developed by others. In other cases, that same IP gets stolen. Finally, sometimes the same problem gets solved through a different path. All three of those results capture some of that lost benefit. While this principle is true across all of manufacturing, it is much more acute in semiconductors due to the higher independence of processing technology from end-product application.

In summary, while U.S. production capacity has been stable, the United States lacks sufficient capacity on a relative basis to produce semiconductors and relies extensively on sources in Taiwan, South Korea, and China for production. The United States is heavily dependent on a single company—TSMC—for producing its

---

<sup>77</sup> “The semiconductor industry and the power of globalization”, (The Economist, December 1 2018).

<sup>78</sup> “Strengthening the U.S. Semiconductor Industrial Base”, (Semiconductor Industry Association, n.d.).

<sup>79</sup> “Comments of Semiconductor Industry Association to Request for Information, “Charting a Course for Success: America’s Strategy for STEM Education” 85 Fed. Reg. 55323 (Sept. 4, 2020)”, (Semiconductor Industry Association, October 19 2020).

<sup>80</sup> Falan Yinug, “Chipmakers Are Ramping Up Production to Address Semiconductor Shortage. Here’s Why that Takes Time”



leading edge chips and has significant dependence on China for mature node logic chips. Since semiconductors are such key components, the fragile supply chain for semiconductors puts virtually every sector of the economy at risk of disruption. Recent events affecting global supply chains, such as the COVID-19 pandemic, weather-related events, and the blockage of the Suez Canal demonstrate the importance of preparedness and supply chain resilience. The lack of domestic production capability also puts at risk the ability to supply current and future national security and critical infrastructure needs. U.S. production is also threatened by significant Chinese investments to expand its chip production capability and a greying of the U.S. workforce.

## SEMICONDUCTOR ASSEMBLY, TEST, AND PACKAGING AND ADVANCED PACKAGING

This section reviews the back-end segment of chip production, ATP, as well as the related U.S. supply base, and discusses the advanced packaging supply chain, including current resilience and risks.

### Semiconductor ATP: Overview

In the back-end ATP stage, chips are assembled into finished semiconductor components, tested, and packaged for incorporation into finished products. The ATP stage occurs under two models: (1) by IDMs and foundries or (2) by Outsourced Semiconductor Assembly and Test (OSAT) companies that specialize at the test and assembly business and provide services on contract. While U.S. companies have 28 percent of the market share of ATP revenues and 43 percent of the market share of IDM ATP revenues (followed by South Korea, Japan and Europe), as noted below, companies have outsourced ATP production to facilities outside the United States. Foundries such as TSMC (Taiwan), UMC (Taiwan), SMIC (China), and XMC (China) have entered the packaging business to increase the manufacturing services they offer to their fabless customers, especially the advanced packaging of chiplets. TSMC introduced its first advanced packaging solution in 2012.<sup>81</sup> In 2017, there were more than 100 different OSATs in the market.<sup>82</sup> There are eight large OSATs; most are small- to mid-sized players.

While there are some U.S. OSAT companies (notably Amkor), U.S.-based companies only represent 15 percent of OSAT business (Taiwan leads with 52 percent, followed by China with 21 percent), and Amkor, while headquartered in the United States, does not have a U.S. production facility.

ATP Market Share (by Revenue)

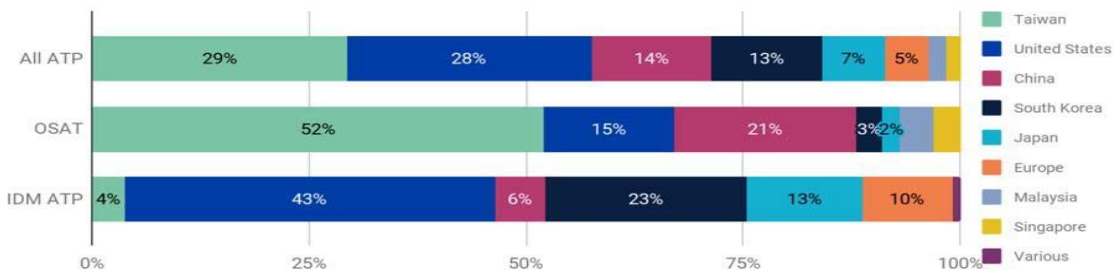

Source: CSET, VLSI Research

Traditionally, ATP has been an automated and lower value business that requires considerable floor space and employs mostly low-tech workers (this is changing with the introduction of advanced packaging techniques discussed below). Consequently, this was the first stage of production to be outsourced (starting in the 1970s), primarily into Southeast Asia. Today, the majority of ATP takes place in China, Taiwan and Southeast Asia (Singapore, Malaysia, Philippines, and Vietnam). SEMI and Techsearch identified more than 120 OSAT companies and 360 packaging facilities around the world for 2018. Of the 360 facilities, more than 100 were in China, around 100 in Taiwan, and 43 in Southeast Asia (the other facilities were in Europe

<sup>81</sup> Herb Reiter, "TSMC's Advanced IC Packaging Solutions", (SemiWiki.com, May 1 2020).

<sup>82</sup> Mark Lapedus, "What Next for OSATs", (Semiconductor Engineering, March 6 2017).

or the Americas).<sup>83</sup> China's OSAT production is current to the mainstream packaging technologies, but China is developing advanced packaging technologies."<sup>84</sup>

In addition, with respect to testing, for national security considerations, semiconductor technologies must be qualified and tested for use over military temperature ranges (extended range), radiation resistance, and harsh environments. This involves, among other things, single event effects (SEE) testing using heavy-ion radiation-testing infrastructure. The existing U.S. heavy-ion radiation-testing infrastructure is fragile and cannot meet current or future SEE testing demand. Customers are already experiencing long wait times and rising testing prices, and it could easily suffer major strains if even a single major facility closes down suddenly. "There are fewer than half a dozen accelerator laboratories that can produce ion beams with sufficient ion species and energies to meet the needs of SEE testing."<sup>85</sup> This impacts availability of testing to support future space missions among space agencies and industry, including satellites.

### **Semiconductor ATP: Risk**

Today, the United States only has three percent of worldwide semiconductor packaging capacity (this does not include testing capacity)<sup>86</sup> mostly provided by IDMs, which often have their ATP facilities outside the United States. While this has been a historically low-tech component of the supply chain, it is a critical step. The United States' dependence on ATP production in Southeast Asia, Taiwan and China exposes the U.S. supply chain to disruptions.

### **Semiconductor Advanced Packaging: Overview**

While, as noted above, ATP has historically been a low-value component of the supply chain, packaging is increasingly becoming more advanced. For decades, the semiconductor industry has followed Moore's Law, which provides that the number of transistors on a semiconductor doubles roughly every two years. Today, the power and performance benefits of chip scaling are diminishing at each new node while the cost per transistor has been increasing. While scaling remains an option, as it becomes more expensive and difficult, the semiconductor industry is searching for alternatives, including putting chiplets and/or more than one integrated circuit into one package. This is known as advanced packaging.<sup>87</sup> Advanced packaging represents both an alternative and complementary technology to linewidth shrinks as it offers higher chip density at the packaging instead of the chip level and allows for integration of different chip functions in a single package. Advanced packaging also allows for increased use of commercial-off-the-shelf (defense approved) chips for custom solutions.

Advanced packaging types include chip stacking technologies—especially for memory chips— and embedded die, fan-out wafer-level packaging and system-in-package (combining chiplets or multiple chips in one package).<sup>88</sup> One approach with logic chips has been to separate standardized IP functions into distinct, smaller chips, called "chiplets" that are connected via standard interfaces on a single package. A chiplet functions with other chiplets, so the design must be co-optimized and the silicon cannot be designed in isolation.<sup>89</sup> The Defense Advanced Research Projects Agency (DARPA) and the Department of the Navy as well as industry participants (AMD, Marvell, and Intel) have had a number of projects exploring this approach. Advanced packaging has significant value for national security to enable disaggregation of

---

<sup>83</sup> SEMI, "Industry's Only Worldwide OSAT Manufacturing Sites Database Now Tracks 360 Facilities, Expands Test Site Coverage", (PR Newswire, November 20 2019).

<sup>84</sup> Mark Lapedus, "China Speeds Up Advanced Chip Development", (Semiconductor Engineering, June 22 2020).

<sup>85</sup> "Testing at the Speed of Light", (The National Academies of Sciences Engineering, and Medicine, 2018).

<sup>86</sup> SEMI, "Public Comment 52. SEMI. Kim Ekmark. 04/05/21", (Regulations.gov, April 5 2021).

<sup>87</sup> Mark Lapedus, "Shortages, Challenges Engulf Packaging Supply Chain", (Semiconductor Engineering, February 18 2021).

<sup>88</sup> "Advanced Packaging: A collection of approaches for combining chips into packages, resulting in lower power and lower cost", (Semiconductor Engineering, n.d.).

<sup>89</sup> TechSearch International, "TechSearch International Quantifies Heterogeneous Integration Market Growth", (3DInCities, February 24 2021).

functional, security, volume, environmental performance, thus allowing customizable device for unique national security applications.

In 2019, advanced packaging made up 42.6 percent of total semiconductor packaging by value and is expected to reach nearly half of the total semiconductor packaging market by 2025.<sup>90</sup> This would be a compound annual growth rate (CAGR) of 6.1 percent from 2014 to 2025, more than doubling advanced packaging revenue from \$20 billion in 2014 to roughly \$42 billion in 2025. This is almost triple the expected growth for the traditional packaging market, estimated at a 2.2 percent CAGR from 2014 to 2025.<sup>91</sup>

### **Advanced Packaging: Current Resilience**

The top 10 advanced packaging companies include: two IDMs (Intel (U.S.) and Samsung (South Korea)); a foundry (TSMC (Taiwan)); the top five global OSATs (ASE Group (Taiwan), SPIL (Taiwan), Amkor (U.S.), Powertech Technology (Taiwan), and JCET (China)) and two smaller OSATs: Nepes Display (South Korea) and Chipbond (Taiwan)). These 10 companies process approximately three-fourths of all advanced packaged chips.<sup>92</sup>

Advanced packaging in the United States is primarily provided by IDMs, including Intel, Texas Instruments, and Micron.<sup>93</sup> One U.S.-based foundry, GlobalFoundries also provides advanced packaging services.<sup>94</sup> In addition, smaller companies, such as Micross, Skywater and Qorvo, provide advanced packaging services to supply niche defense and industrial needs.<sup>95</sup>

While China does not currently have strong advanced packaging capabilities, as noted above, it is developing advanced packaging capabilities in order to compensate for its lack of production of leading-edge semiconductors.<sup>96</sup>

In addition, as capabilities and demand for advanced packaging grow, comments submitted in response to the Federal Register Notice of Inquiry (NOI) note that the United States' lack of capabilities in advanced packaging substrates (which are based on printed circuit board technologies) and related supply chains present vulnerabilities.<sup>97</sup> Suppliers for substrates are based in Asia. Key substrate companies include: Ibiden (Japan), Nanya (Taiwan), Shinko (Japan), Samsung (South Korea), Unimicron (Taiwan), Shennan Circuits (China), Zhuhai Yueya (China), and AKM Electronics Industrial (China).<sup>98</sup> In addition, printed circuit board

---

<sup>90</sup> Kumar et al., “Webinar: Trends and Challenges in Semiconductor Advanced Packaging”, (Semiconductor Industry Association, September 29 2020).

<sup>91</sup> Santosh Kumar, Favier Shoo, and Vaibhav Trivedi, "Status Of The Advanced Packaging Industry 2020: Market & Technology Report - July 2020", (Yole Development, July 2020).

<sup>92</sup> “Advanced Packaging Current Trends & Challenges”, (Yole Development, 2020).

<sup>93</sup> Kumar et al., “Webinar: Trends and Challenges in Semiconductor Advanced Packaging”

<sup>94</sup> Mark Lapedus, “The Next Advanced Packages”, (Semiconductor Engineering, June 18 2020).

<sup>95</sup> “Advanced Interconnect Technology”, (Micross, 2021); “Advanced Packaging: Qorvo's Centers of Excellence”, (Qorvo, 2021); “SkyWater’s Florida Expansion Accelerates Domestic Advanced Packaging Capabilities for Microelectronics Manufacturing”, (Skywater, n.d.).

<sup>96</sup> Seunghyuk Choi, Christopher Thomas, and Florian Weig, “Advanced-packaging technologies: The implications for first movers and fast followers”, (McKinsey, Autumn 2014).

<sup>97</sup> Chipletz Inc, “Public Comment 34. Chipletz Inc. Jay Owen. 04/05/21”, (Regulations.gov, April 6 2021); TTM Technologies, “Public Comment 15. TTM Technologies. Thomas Edman. 04/02/21”, (Regulations.gov, April 6 2021); IPC and USPAAE, “Public Comment 91. IPC and USPAAE. Chris Mitchell. 04/05/21”, (Regulations.gov, April 6 2021); Calumet Electronics Corporation, “Public Comment 89. Calumet Electronics Corporation. Todd Brassard. 04/05/21”, (Regulations.gov, April 6 2021); Purdue University, “Public Comment 93. Purdue University. Carol Handwerker. 04/05/21”, (Regulations.gov, April 6 2021); Flextech Alliance, “Public Comment 77. Flextech Alliance Inc DBA NextFlex. Malcolm Thompson. 04/05/21”, (Regulations.gov, April 6 2021).

<sup>98</sup> Saif M. Khan, Alexander Mann, and Dahlia Peterson, “The Semiconductor Supply Chain: Assessing National Competitiveness”, (Center for Security and Emerging Technology, January 2021).

manufacturing has shifted to China, making China a more attractive market for substrate suppliers.<sup>99</sup> IPC/U.S. Partnership for Assured Electronics (USPAE) estimates the United States is 20 years behind Asia in printed circuit board manufacturing technologies necessary for next-generation electronics applications and 30 years behind in the capability to manufacture the printed circuit board manufacturing-like substrates necessary for advanced microelectronics packaging.<sup>100</sup> The U.S. printed circuit board manufacturing industry, which once accounted for more than 30 percent of total global production, today accounts for less than five percent.<sup>101</sup>

### **Semiconductor Advanced Packaging: Risks**

Key risks pertaining to advanced packaging are reviewed below.

- **Chinese Investments in Advanced Packaging Threaten to Upend the Market in the Future:** While China lacks strong advanced packaging capabilities, the Chinese government has made significant investments in advanced packaging. For the past several years, advanced packaging has been a technology priority for the Chinese semiconductor industry, with the State Council aiming to have advanced packaging account for about 30 percent of all packaging revenues earned by Chinese vendors by 2015.<sup>102</sup> In January 2021, SMIC's newly hired vice chairman said that Chinese companies should focus on advanced packaging to overcome their weakness in reducing semiconductor linewidth, probably signaling that SMIC will be aggressively moving into advanced packaging.<sup>103</sup> Stephen Hiebert, senior director of marketing at U.S. semiconductor packaging equipment company KLA reported in 2018 " ... we see strong O S A T investment in China as advanced packaging capacities ramp to match Chinese front-end fab projects." <sup>104</sup>
- **Lack of Capabilities in Materials for Advanced Packaging:** Advanced packaging substrates, which are based on printed circuit board technologies, and printed circuit board manufacturing is primarily based in Asia, with the latter based primarily in China. This creates challenges for companies seeking to invest in advanced packaging in the United States.
- **Defense Needs Alone Are Insufficient to Keep Advanced Packaging Onshore:** A handful of U.S. companies provide advanced packaging solutions for defense needs, which comprise a small share of the market. As advanced packaging capabilities continue to grow outside the U.S., they will soon overwhelm the volume of defense needs and market forces will draw leading-edge capabilities offshore. Ultimately, volume drives both innovation and operational learning; in the absence of the commercial volume, the United States will not be able to keep up either with the technology, in terms of quality, cost, or workforce.

In summary, the United States relies on foreign sources concentrated in Asia for back-end ATP capabilities, creating supply chain disruption risks in this segment of the supply chain. Packaging is becoming more advanced as the industry is pursuing new approaches to compensate for the complexity, lower yield, and diminishing marginal returns of ever-smaller feature sizes at the most advanced or smallest nodes. While the United States and its partners have advanced packaging capabilities, China's massive investments in advanced

---

<sup>99</sup> The loss of technological leadership in printed circuit boards shows weaknesses in the electronics supply chain beyond semiconductors that is not the subject of this report, but as commenters to the federal register notice have indicated, are weaknesses that also need to be addressed to ensure a strong supply chain.

<sup>100</sup> IPC and USPAE, "Public Comment 91. IPC and USPAE. Chris Mitchell. 04/05/21", (Regulations.gov, April 6 2021).

<sup>101</sup> IPC and USPAE, "Public Comment 91. IPC and USPAE. Chris Mitchell. 04/05/21"

<sup>102</sup> Seunghyuk Choi, Christopher Thomas, and Florian Weig, "Advanced-packaging technologies: The implications for first movers and fast followers"

<sup>103</sup> Che Pan, "SMIC urges China's chipmakers to embrace advanced packaging as Moore's Law slows nanometre node progress and US sanctions bite", (Yahoo News, January 25 2021).

<sup>104</sup> Mark Lapedus, "Packaging Challenges For 2018", (Semiconductor Engineering, January 8 2018).

packaging threaten to upend the market in the future. In addition, the United States lacks the ecosystem for developing advanced packaging technologies.

## **Semiconductor Materials**

As described above, modern chip manufacturing is an incredibly complex process, involving hundreds of steps completed over several months. Among the essential inputs for semiconductor manufacturing are hundreds of materials that are used in various stages of the fabrication process. It is beyond the scope of this 100-day review to evaluate all of the inputs for the semiconductor manufacturing process.<sup>105,106</sup> One market research firm estimates that the global market for electronic materials and chemicals and gases for the semiconductor industry was valued at \$18.3 billion in 2020 and is predicted to grow to \$26.2 billion by 2025.<sup>107</sup> However, the following provides a brief review of the supply chain for certain key semiconductor materials.

### *Polysilicon*

The process of manufacturing semiconductors starts with silicon, which is the second most abundant element in the earth's crust. Although most silicon is used in the steel and aluminum industries, metallurgical grade silicon is used to produce polysilicon, a high purity form of silicon used in the electronics and solar industries. The semiconductor supply chain begins with polysilicon of ultra-high purity – 99.9999999999 percent pure. It is often referred to as “11 Nines” — with impurities equivalent to just one grain of sand in 16 Olympic-sized swimming pools. To produce the ultrahigh purity polysilicon, silicon is combined with chemicals such as trichlorosilane gas in a very energy intensive process. Polysilicon used in the solar industry is of a lesser grade, known as “9 Nines” pure, and solar applications account for 90 percent of demand for polysilicon.<sup>108</sup>

There are several manufacturers of electronics-grade polysilicon with manufacturing in the United States, including Hemlock Semiconductor (Michigan), Norway-based REC Silicon, Germany-based Wacker Polysilicon, and Japan-based Mitsubishi Materials America. U.S.-based Hemlock Semiconductor indicated that it has the capacity to increase polysilicon production by 50 percent, yielding up to 35,000 tons of polysilicon per year.<sup>109</sup> Although the U.S. currently has production capacity, according to the domestic producers, U.S. technological leadership and production of semiconductor-grade polysilicon is at risk due to China's actions to increase its dominance of both the semiconductor and solar supply chains. As a result of these actions, which include a high tariff on polysilicon imported to China, U.S. polysilicon producers have been cut off from the Chinese market, which represents over 95 percent of the global solar-grade polysilicon market. Direct and immediate customers in the solar industry currently do not exist in the United States. Because the production processes for semiconductor grade and solar grade polysilicon are closely related, U.S. producers must be able to take advantage of a robust global market for solar energy products to ensure continued production of material for semiconductors.<sup>110</sup> According to these producers, China now accounts for over 70 percent of polysilicon production capacity, and U.S. producers, nine percent.<sup>111</sup>

---

<sup>105</sup> In response to the Notice of Inquiry, several of those commenting noted supply chain vulnerabilities for specific materials used in the semiconductor manufacturing process, including ABF substrate, lanthanum, cerium, scandium, cesium, hydrogen fluoride, and helium.

<sup>106</sup> For more information on specific semiconductor materials see: Saif M. Khan, Alexander Mann, and Dahlia Peterson, “The Semiconductor Supply Chain: Assessing National Competitiveness”

<sup>107</sup> “Electronic Chemicals and Materials: The Global Market”, (BCC Research, January 2021).

<sup>108</sup> Johannes Bernreuter, “Polysilicon Uses: The lion's share has shifted from semiconductor to solar”, (Bernreuter Research, June 29 2020).

<sup>109</sup> Taylor DesOrmeau, “Hidden in the cornfields, Michigan has its own little silicon valley”, (MLive, April 6 2021).

<sup>110</sup> “Transcript: Virtual Forum for Risks in the Semiconductor Manufacturing and Advanced Packaging Supply Chain”, (Bureau of Industry and Security, April 8 2021).

<sup>111</sup> “65% surge in polysilicon prices triggers unexpected increase in module production costs and affects solar installation outlook in 2020”, (IHSMARKIT, September 2 2020).

## *Semiconductor Wafers*

After the polysilicon is produced it must be grown into ingots, the ingots are then sliced to make the thin disk-shaped silicon wafers from which the chip manufacturing process begins. The United States lacks the manufacturing capacity to transform polysilicon into polished, blank wafers. As most semiconductors are made of silicon, this is a key vulnerability.

The major players in the silicon wafer market—which are capable of producing 300 mm wafers used in state-of-the-art semiconductor fabs—are headquartered in Japan, Taiwan, Germany, and South Korea. Japanese firms are dominant in this sector, with an estimated 56 percent share of the market, followed by Taiwan (16 percent), Germany (14 percent), and South Korea (10 percent). Only small U.S. firms, such as Virginia Semiconductor, manufacture silicon wafers, although some of the foreign (German, Japanese, and Taiwanese) firms have production facilities in the United States. China is not a major player in this market, and has very limited capability to make 300 mm wafers; the estimated market share of Chinese firms is less than five percent.<sup>112</sup>

The global semiconductor industry has been constantly increasing the diameter of silicon wafers used as the larger the diameter of the wafer, the more real estate of silicon is available for manufacturing. At present, the semiconductor industry is widely making use of 300 mm wafers; investments for 450 mm wafer production were explored by a collection of leading manufacturers, but significantly higher manufacturing costs for semiconductor processing tools and lower expected returns on investment led to the abandonment of this approach. Two hundred mm wafers also continue to have a large market, especially for commodity semiconductors.

With respect to silicon wafer manufacturing equipment, according to comments submitted in response to the NOI, most of the specialized equipment, including the special furnaces used to grow ingots from polysilicon called Czochralski, or CZ pullers; and the special materials used to transform polysilicon into wafers, including quartz crucibles, graphite parts, and slicing wire; are sole-sourced or not produced in the United States.<sup>113</sup>

Although the vast majority of commercial semiconductors are produced from silicon wafers, compound semiconductors, which feature a thin coating of a material with different physical and conductive properties, are better suited to key emerging applications in 5G communications, autonomous vehicles, renewable energy and military systems. These materials, which include germanium, gallium arsenide (GaAs), GaN, and SiC, continue to function well beyond the temperature threshold of silicon, and can thus deliver superior performance with lower size, weight and power requirements. Compound semiconductors have historically been developed for military or specialty communications and optoelectronics applications and have been more expensive. However, as they are increasingly being used commercially and there have been developments in GaN and SiC, the cost differential has decreased.

The United States currently has a leadership position in GaN microwave electronics for radar, electronic warfare and communications. Other countries, especially China, are making large national investments to create their own GaN electronics capabilities.<sup>114</sup>

The Department of Energy has long recognized the importance of developing compound semiconductors for power electronics, having established Power America, a Manufacturing USA Institute in 2015. Power America is a consortium of 60 companies, universities and federal laboratories focused on accelerating the adoption of U.S.-made SiC and GaN in applications such as electric vehicles, renewable energy, grid

---

<sup>112</sup> Saif M. Khan, Alexander Mann, and Dahlia Peterson, “The Semiconductor Supply Chain: Assessing National Competitiveness”

<sup>113</sup> Linton Crystal Technologies, “Public Comment 9. Linton Crystal Technologies. Todd Barnum. 03/31/21”, (Regulations.Gov, March 31 2021); SEMI, “Public Comment 52. SEMI. Kim Ekmark. 04/05/21”

<sup>114</sup> PowerAmerica, “Public Comment 45. PowerAmerica. Victor Veliadis, Ph.D.. 04/05/21”, (Regulations.gov, April 6 2021).

resilience, and mass transit systems.<sup>115</sup> In addition, DARPA has funded numerous programs focused on indium phosphide, GaAs, SiGe, SiC, GaN and aluminum nitride plus recent work on ultra-wide bandgap semiconductors.<sup>116</sup> Beyond this investment in research, however, there remains a significant need for a domestic foundry, as foundry services for SiC and GaN are mainly offshore.<sup>117</sup>

The United States is a global leader in deployment of SiC, making it a true competitiveness success story, due in large part to consistent and substantial U.S. Government investments over decades. The United States has homegrown SiC companies and has also attracted significant foreign direct investment. Cree Power (U.S.) is perhaps the best-known example of the former. With regard to foreign direct investment, Infineon (Germany) has dramatically increased its U.S. presence in recent years with the acquisitions of American companies International Rectifier in 2015 and Cypress Semiconductors in 2020.

#### *Photomasks and Photoresists*

Photomasks, including reticles, are plates that contain the pattern used to produce integrated circuits. Since custom photomasks are usually identified by end-user, they are one of the areas of the semiconductor supply chain that pose the most risk for malicious tampering.

As transistors have become smaller and smaller, photomasks have also become more complex in order to accurately transfer increasingly complex patterns onto the silicon wafers. Masks are made using a process similar to that used to make the chips themselves, using e-beam lithography and laser lithography machines. During the photolithography step of the semiconductor fabrication process, light is shined through the photomasks to produce a pattern on the wafer. A photoresist, which is a light sensitive organic material used to form a pattern, is then applied to the wafer, which is then exposed to light using a photolithography tool. The pattern created in the photoresist is then etched in the wafer to create the minute, highly complex circuit patterns of the semiconductor design. Photomasks for state-of-the-art chip manufacturing, using EUV technology, are significantly different than conventional photomasks. EUV masks work by reflecting light, rather than blocking light and use a silicon and molybdenum layered substrate rather than chromium and quartz.

Captive production of photomasks is common among large semiconductor firms. Intel (U.S.), Samsung (South Korea), TSMC (Taiwan), and SMIC (China) all have in-house mask making operations. Fabless semiconductor companies, however, rely on merchant photomask manufacturers, leaders of which are headquartered in Japan, the United States, and Taiwan. The Center for Security and Emerging Technology (CSET) estimates that Japanese firms control 53 percent of the merchant mask market, while U.S. firms have 40 percent, and Taiwanese firms, seven percent.<sup>118</sup>

According to the CSET supply chain study, Japanese firms also dominate the semiconductor photoresist market, with an estimated 90 percent share. The remaining 10 percent is held primarily by firms based in the United States and South Korea. China has little indigenous capacity to produce advanced photoresists.

#### *Ultra-Pure and Regular Chemicals and Gases*

There are many providers of chemicals and gases for the semiconductor industry, with leading companies based in the United States, Japan, and Europe. Foreign companies usually have a presence in the United States. The bulk of the business of most chemical and gases providers is outside of the semiconductor industry.

---

<sup>115</sup> PowerAmerica, “Public Comment 45. PowerAmerica. Victor Veliadis, Ph.D.. 04/05/21”

<sup>116</sup> National Defense Industrial Association, “Public Comment 73. National Defense Industrial Association (NDIA). Nick Jones. 04/05/21”, (Regulations.gov, April 6 2021).

<sup>117</sup> PowerAmerica, “Public Comment 45. PowerAmerica. Victor Veliadis, Ph.D.. 04/05/21”

<sup>118</sup> Saif M. Khan, Alexander Mann, and Dahlia Peterson, “The Semiconductor Supply Chain: Assessing National Competitiveness”

The United States, Japan, and France produce semiconductor gases. Currently, the six largest suppliers – Versum Materials (U.S.), SK Materials (South Korea), MTG/TNS (Japan), Air Liquide (France), Linde/Praxair (U.K./U.S.), and KDK (Japan) – control about half of the overall market, with about 50 suppliers accounting for the other half of the market.<sup>119</sup>

The United States, Germany and Japan are leading producers of wet chemicals. KMG Chemicals (U.S.), Avantor (U.S.), Honeywell (U.S.), BASF (Germany), and Kanto Chemical (Japan) have more than 60 percent of the market share of wet chemicals.<sup>120</sup>

### *Raw Materials*

The raw materials used to produce wafers – including silicon and gallium– are concentrated in China. Helium gas is also in shortage. The U.S. is a source of helium however, it is a by-product of natural gas production and therefore subject to gas prices.<sup>121</sup>

Some of the critical materials, minerals, and rare earth elements discussed in the critical minerals and materials' supply chain review required under Executive Order (E.O.) 14017 are used in semiconductor manufacturing (including gallium and polysilicon). However, although these materials are critical to the semiconductor manufacturing process, other uses of these materials are consumers of these materials,<sup>122</sup> and the issues for these materials are not particular to the semiconductor industry.

### **Semiconductor Materials: Risks**

- **Variety of Materials Required:** The incredibly complex semiconductor manufacturing process requires hundreds of essential inputs, many of which are raw materials, chemicals, and gases. These materials have their own complex supply chains, and likely contain hidden choke points that could disrupt production. In addition to the raw materials, compound semiconductor materials are increasingly important to commercial and military applications. Global leadership in automated vehicles, renewable energy, and cloud computing will require sustained investment in materials research, both to understand and characterize unique material properties, and to utilize them in such a manner that effectively exploits those properties.<sup>123</sup>
- **Dependence on Foreign Sourcing:** Many of the materials used in semiconductor manufacturing have limited production in the United States. The majority of silicon wafers are manufactured in Japan, with an additional quarter of the supply filled by nearby Taiwan and South Korea. In addition, some raw materials, including silicon and gallium, are primarily sourced from China. Certain specialty inputs such as certain electronic grade gases and chemicals, also have limited domestic sourcing, if any.<sup>124</sup> A disruption in the supply of any of these materials could have far-reaching impacts on semiconductor production.
- **Geographic Concentration of Suppliers:** In addition to a dependence on non-U.S. sources, many of the foreign sources of materials for semiconductor manufacturing are concentrated in East Asia. As noted above, gallium and indium are primarily sourced from China, and silicon wafers, photomasks, and

---

<sup>119</sup> Mike Corbett and Andy Tuan, “Opportunities in Electronic Specialty Gases”, (SEMI, October 9 2019).

<sup>120</sup> Saif M. Khan, Alexander Mann, and Dahlia Peterson, “The Semiconductor Supply Chain: Assessing National Competitiveness”

<sup>121</sup> “U.S. Geological Survey, Mineral Commodity Summaries: Helium”, (U.S. Geological Survey, January 2021).

<sup>122</sup> An illustrative list of raw materials used in semiconductor manufacturing can be found on page 54 of Saif M. Khan, Alexander Mann, and Dahlia Peterson, “The Semiconductor Supply Chain: Assessing National Competitiveness”

<sup>123</sup> Brewer Science, “Public Comment 56. Brewer Science. A. Freedman. 04/05/21”, (Regulations.gov, April 6 2021).

<sup>124</sup> SEMI, “Public Comment 52. SEMI. Kim Ekmark. 04/05/21”; Pure Helium LLC, “Public Comment 25. Pure Helium LLC. Alex Cranberg. 04/05/21”, (Regulations.gov, April 6 2021).



photoresist are primarily sourced from Japan. Additional sources of supply are largely concentrated in Taiwan and South Korea.

- **Safety, Availability, and Transportation of Chemicals and Gases:** Long distance supply chains for chemicals and gases can present a safety and material purity concern, and semiconductor manufacturing requires the constant input of certain gases and chemicals. Gases and chemicals companies often have production/services near semiconductor fabs for this reason. The high-purity wet chemicals are already in short supply, as, according to public comments, the low margins leave no incentive to expand production capacity.<sup>125</sup>

In summary, foreign suppliers dominate the market for silicon wafers, photomasks and photoresists. Japanese companies are especially strong in these industry sectors. The products, however, are manufactured in various locations throughout the world, and many of the foreign-headquartered companies have production facilities in the United States to serve domestic semiconductor manufacturers. The United States and ally countries produce gases and wet chemicals for semiconductors. China does not have competitive, technologically advanced indigenous production capability for wafers, photomasks, or photoresists. However, China is the leading global supplier for gallium, one of the base elements for gallium nitride and gallium arsenide semiconductors.

## **SEMICONDUCTOR MANUFACTURING EQUIPMENT**

### **SME: Overview**

There are multiple categories of SME, each used in a different step of semiconductor production line. There are equipment types specific to manufacturing bare wafers (covered under "Materials" above), processing the bare wafer to semiconductors on a wafer (Front-end), packaging (Back-end), and equipment for manufacturing photomasks (mask manufacturing). Chip manufacturers need all the categories of front-end equipment in their manufacturing line. The cost of complex front-end semiconductor manufacturing equipment is a major reason (along with construction costs) for the high cost of a semiconductor fab.<sup>126</sup>

Front-end SME include equipment for fabrication steps, including lithography, etching, doping or ion implantation, deposition, and polishing or chemical mechanical planarization. Of particular note is metal organic chemical vapor deposition (MOCVD) equipment, a specific type of deposition equipment that deposits thin layers of certain metals, used primarily for the production of compound semiconductors, including those based on GaAs and GaN. Back-end SME includes equipment for ATP and advanced packaging.

### *SME: Current Resilience*

The SME industry is dominated by companies in the United States (41.7 percent share by revenue), Japan (31.1 percent share), and the Netherlands (18.8 percent share). South Korea has 2.2 percent share, and the rest is shared among China, Germany, Taiwan, Israel, Canada, and additional countries in Southeast Asia and Europe.<sup>127</sup> Many of the South Korean SME companies are owned by Samsung or SK hynix, or one of these South Korean semiconductor companies is their primary customer.<sup>128</sup> Although there is a Chinese company producing every category of semiconductor manufacturing equipment, Chinese companies do not have a notable share of any category except assembly and packaging equipment and MOCVD.

---

<sup>125</sup> SEMI, "Public Comment 52. SEMI. Kim Ekmark. 04/05/21"

<sup>126</sup> Saif M. Khan, Alexander Mann, and Dahlia Peterson, "The Semiconductor Supply Chain: Assessing National Competitiveness"

<sup>127</sup> Saif M. Khan, "Securing Semiconductor Supply Chains", (Center for Security and Emerging Technology, January 2021).

<sup>128</sup> Hyeryung Kang, "South Korean Semiconductor Equipment Makers Benefit from Samsung Electronics' New Investments While Display Equipment Makers Look towards the Chinese Market for Opportunities", (Korea IT News, May 28 2020).

The top five semiconductor manufacturing equipment companies for 2019 were Applied Materials (U.S. – 18.8 percent world market share), ASML (Netherlands – 16.8 percent), Tokyo Electron (Japan – 13.4 percent), Lam Research (U.S. – 11.8 percent) and KLA Corporation (U.S. – 6.8 percent),<sup>129</sup> for a total 67.6 percent of the world market (by value).

As indicated in the figure below, while the United States has significant market share in the production of most front-end SME, the notable exception is for lithography scanning/stepper equipment, which is almost all manufactured by the Dutch company ASML and Japanese companies Nikon and Canon.

One piece of SME can have over 100 parts, and parts of and accessories for SME (HS 848690) is the largest trade category for this industry. According to the Census Survey of Manufacturers, half of the revenue for sales of U.S. semiconductor manufacturing equipment is spent on parts and other materials.<sup>130</sup> U.S. companies provide key parts for equipment sold by foreign companies. Notably, Cymer (U.S.) manufactures the lasers for ASML's EUV stepper/scanner lithography machines. ASML acquired Cymer in 2013, but Cymer remains a separate operating unit in ASML located in the United States. Also, some of the minerals and materials referred to in the "Materials" section above are used in the manufacture of semiconductor manufacturing equipment.

Due to the limited market and customers and the cyclical nature of sales, most of the large equipment companies manufacture more than one type of equipment so they can offer a full suite of devices and upkeep options to customers. Lithography stepper/scanner equipment companies such as ASML are an exception to this rule because of the unique technologies of the equipment. Lam Research specializes in deposition and etch, Tokyo Electron (TEL) in deposition and etch, and KLA in metrology and inspection.<sup>131</sup>

---

<sup>129</sup> "2019 Top Semiconductor Equipment Suppliers; The year was won by ALD, Process Control, EUV, and SOC Test"

<sup>130</sup> "2019 Annual Survey of Manufactures (ASM)" (U.S. Census Bureau, 2019).

<sup>131</sup> Peter Clarke, "ASML loses its crown in semiconductor manufacturing equipment", (EENews Europe, November 30 2020).

## IC Manufacturing Equipment Market Shares

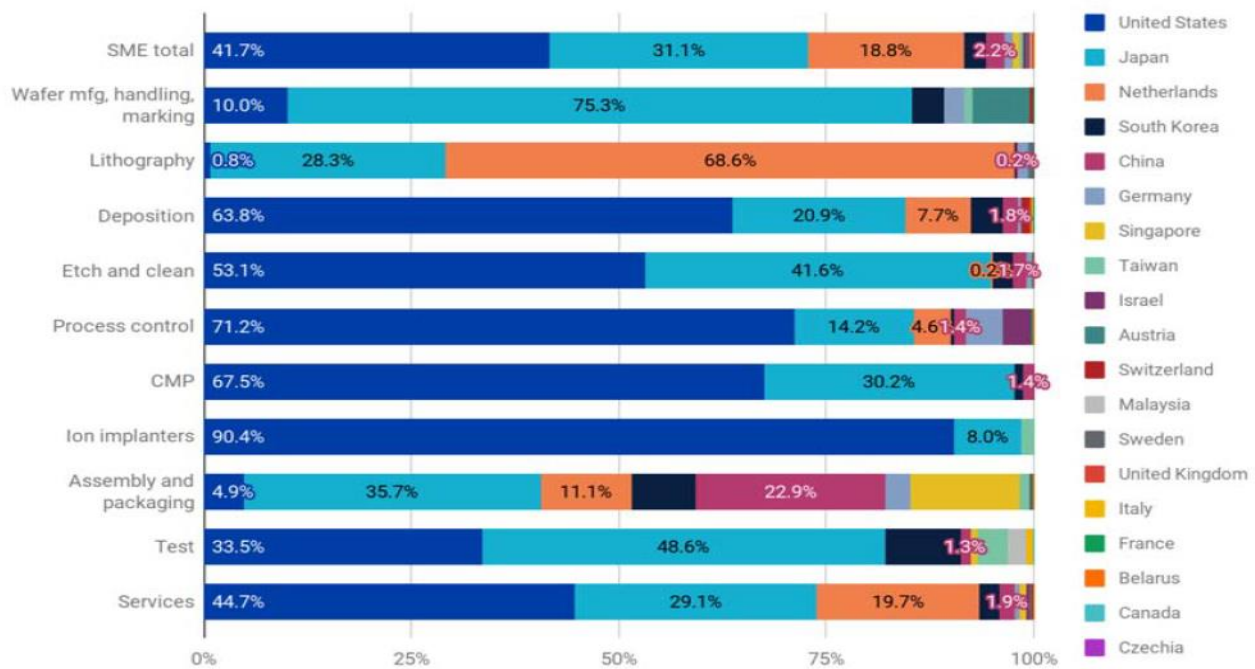

Source: VLSI Research

Source: CSET (based on VLSI Research data)<sup>132</sup>

As indicated above, for lithography, ASML (Netherlands) is the sole producer of EUV stepper/scanners, which are essential for producing integrated circuits with a linewidth of 5 nm or less. However, only two semiconductor manufacturers, TSMC and Samsung, currently use EUV machines in production, which cost more than \$100 million. Both ASML and Nikon produce Deep Ultra-Violet (DUV) photolithography machines that cast a beam of light through a photomask and creates a small image of the photomask's pattern onto a wafer. Outside of the Netherlands and Japan, the United States and other countries' share in lithography equipment is primarily in lithography equipment for specific lower volume chips or for making photomasks.

An exception to Japanese and Dutch leadership is MOCVD equipment, which is used in the production of semiconductors made from materials other than silicon (such as GaN and GaAs), including LEDs, laser diodes and other photonic chips, power/RF devices, and solar cells. As mentioned above, there are defense implications for GaN chips. MOCVD equipment is manufactured by Veeco (U.S.), Aixtron (Germany) and AMEC (China). China attempted to gain market share in the MOCVD market through acquisitions. In 2016, Chinese entity Fujian Grand Chip Investment Fund, a company formed for the transaction that included state-and regional owned bodies, tried to buy Aixtron, but the prospective acquirer dropped its takeover bid after the deal was blocked by President Obama after a review conducted by the Committee on Foreign Investment in the United States (CFIUS).<sup>133</sup>

<sup>132</sup> Saif M. Khan, Alexander Mann, and Dahlia Peterson, "The Semiconductor Supply Chain: Assessing National Competitiveness"

<sup>133</sup> Maria Sheahan, "China's Fujian drops Aixtron bid after Obama blocks deal", (Reuters, December 8 2016); The White House, Presidential Order -- Regarding the Proposed Acquisition of a Controlling Interest in Aixtron SE by Grand Chip Investment GMBH, Dec. 2, 2016.

The top three companies for etching equipment are Lam Research (U.S.), Tokyo Electron (Japan), and Applied Materials (U.S.).<sup>134</sup> Chinese companies, including AMEC, have developed some expertise in etch and can compete in most segments except leading edge, however their market share is only around one percent.<sup>135</sup>

In contrast to front-end SME, the United States has a relatively small market share (4.9 percent) in back-end packaging SME. Japan has the largest share of packaging equipment (35.7 percent), followed by China (22.9 percent) and the Netherlands (11.1 percent). However, U.S.-based Kulicke and Soffa is a leading SME packaging company. The United States and Japan are leaders in back-end test equipment (for ATP), with 33.5 and 48.6 percent of the market share, respectively.

#### *SME: Risks*

Key SME-specific risks are reviewed briefly below.

- **Dependence on Foreign Sales:** While the United States has a significant share of the SME production market, U.S. producers are highly dependent on foreign sales. As the largest manufacturers of semiconductors, Taiwan, China, and South Korea are the largest markets for SME.<sup>136</sup> Although Taiwan is expected to regain its position as top market for SME for 2021 and 2022,<sup>137</sup> due to significant spending in chip production, China's consumption of SME is expected to increase steadily.<sup>138</sup> For example, U.S.-based Applied Materials and Lam Research report that approximately 90 percent of their total revenue in 2020 resulted from non-U.S. sales, with China growing from 16 percent of Lam Research's revenue in 2018 to 31 percent in 2020.<sup>139</sup> Accordingly, U.S. SME producers are at risk of being significantly impacted by trade restrictions between the United States and China or unexpected demand shifts in Asia. The resulting impacts could last far beyond current revenue declines, as semiconductor manufacturers experience some degree of equipment lock-in, with changing equipment providers requiring costly redesigns. Lam Research, for instance, noted in its 2020 annual report that "once a semiconductor manufacturer commits to purchase a competitor's semiconductor manufacturing equipment, the manufacturer typically continues to purchase that competitor's equipment, making it more difficult for us to sell our equipment to that customer." Also, sales of SME are limited to semiconductor companies with fabs, universities, and semiconductor industry consortia—SME companies cannot increase their customer base beyond these categories as this equipment is unique to the semiconductor industry.
- **Chinese Subsidies for SME Production Distort the Market:** In addition, China plans to provide significant subsidies to fund SME production in the country. Phase II of China's National Integrated Circuit Industry Investment Fund, discussed below, focuses on etching machines, deposition, test, and wafer cleaning equipment with funding from \$28.9 to \$47 billion.<sup>140</sup> Subsidies keep the Chinese companies in business even though most do not appear to be making a profit. For example, according to Organization for Economic Co-operation and Development (OECD), "Government equity injections have had discernable effects on the financial performance" of Chinese semiconductor producers where increases in firm assets are not matched by any increase in profitability.<sup>141,142</sup> The subsidies provide

---

<sup>134</sup> Dixuan Lu, Ian Platonov, "China's AMEC – from Etching to MOCVD (and Back?)", (EqualOcean, July 9 2020).

<sup>135</sup> Saif M. Khan, Alexander Mann, and Dahlia Peterson, "The Semiconductor Supply Chain: Assessing National Competitiveness"

<sup>136</sup> "Semiconductor Equipment Consensus Forecast – Record Growth Ahead, SEMI Reports", (SEMI, December 14 2020).

<sup>137</sup> SEMI, "Public Comment 52. SEMI. Kim Ekmark. 04/05/21"

<sup>138</sup> "Semiconductor Equipment Consensus Forecast – Record Growth Ahead, SEMI Reports"

<sup>139</sup> Applied Materials Inc, "Form 10-K", (U.S. Securities and Exchange Commission, October 25 2020); Lam Research Corporation, "Form 10-K", (U.S. Securities and Exchange Commission, June 28 2020).

<sup>140</sup> Christopher Taylor, "Self-sufficiency for China at the Important 28 nm CMOS node: The Plan Can Succeed", (StrategyAnalytics, October 27 2020).

<sup>141</sup> OECD, "Measuring distortions in international markets: The semiconductor value chain", (OECDiLibrary, December 12 2019).

<sup>142</sup> OECD, "Measuring distortions in international markets: The semiconductor value chain"

Chinese companies with access to funds to invest in R&D for the next generation semiconductor manufacturing, affording significant advantages to these companies relative to non-Chinese companies that do not receive such subsidies. In view of the massive R&D and capital expenditure to manufacture SMEs and uncertainties with respect to the timing and location of leading edge chip production, unlike in the past, today, SME makers are reluctant to invest in R&D for the next generation wafer size without a commitment from top semiconductor companies.

- **Shortage of SME for Smaller Wafer Sizes:** Even with widespread use of newer technologies like 300 mm lines, many types of semiconductors especially small surface area discrete semiconductors, compound semiconductors, and mature node integrated circuit semiconductors were designed to be produced on 200 mm or even smaller wafers. As a result, foundries usually have both 200 mm and 300 mm lines, and a notable share of semiconductors production is on 200 mm wafers or even smaller. There is currently a shortage of 200 mm equipment, which shows no sign of abating. More than 200 fabs currently in operation produce semiconductors on 200 mm wafers, mostly for mature node chips (350 nm to 90 nm). Automotive, consumer (gaming), wireless communications, 5G smartphones and LED's are cited as driving demand for 200 mm capacity. In addition, analog, display drivers, power management integrated circuits and radio frequency devices utilize 200 mm wafers or smaller and industrial and power semiconductors—especially GaN or other compound semiconductor often utilize such wafers. An SME company reported that although sales of 200 mm wafer equipment declined from 2010 to 2015 toward a 50-50 split between 200 and 300 mm as expected, demand reversed to 2010 levels. SEMI reports that, in 2019, there were five new 200 mm fabs and seven began construction in 2020 (three in China, and one each in the United States, Japan, and Taiwan). Although equipment for 200 mm used to be available as used equipment, this market has dried up. New equipment at 200 mm is also hard to come by, especially lithography equipment.<sup>143</sup>
- **Industry Consolidation:** Today, new equipment buys will be due to new fabs, technology, features or need to increase output, increasing the importance of services and upgrades and the consolidation of the industry toward large providers with a wide range of products, such as Applied Materials, Tokyo Electron, and Lam Research. This also puts the smaller equipment companies in danger of being absorbed by larger companies or losing sales to subsidiaries of the larger companies.

In summary, the United States has a significant share of global production of most front-end SME with the notable exception of lithography equipment production, which is concentrated in the Netherlands and Japan. The United States also has a significant share of global production of back-end testing equipment. By contrast, the United States has a relatively small market share in global back-end SME packaging equipment while China has a significant share. While China is currently highly dependent on non-Chinese sources for SME (with the exception of packaging and MOCVD), it is providing significant investments focused on production such equipment. These investments afford significant advantages to the beneficiary companies relative to other companies in terms of investments in R&D to produce equipment for leading edge chips.

## RISK ASSESSMENT

The semiconductor manufacturing supply chain is so broad and includes so many materials and processes that identifying risks to the semiconductor supply chain is virtually synonymous with identifying all risks to manufacturing in general. The SIA notes, for example, that one of its members has over 16,000 suppliers, more than half outside the United States, and that a semiconductor may cross international borders as many as 70 times before reaching its final destination.<sup>144</sup> The risks addressed in this report will accordingly not be exhaustive, but represent an attempt to broadly categorize and summarize key risks facing the U.S. semiconductor industry.

---

<sup>143</sup> Mark Lapedus, “200mm Demand Surges”, (Semiconductor Engineering, December 17 2020).

<sup>144</sup> Alam et al. “Globality And Complexity of the Semiconductor Supply Ecosystem”

The many category-specific risks identified above are often symptoms of more general supply chain challenges. The Department of Commerce has identified broad risks that encompass most of the identified threats to semiconductor supply chains: (1) fragile supply chains; (2) malicious supply chain disruptions; (3) use of obsolete and generations old semiconductors and related challenges for continued profitability of companies in the supply chain; (4) customer concentration and geopolitical factors; (5) electronics production network effects; (6) human capital gaps; (7) IP theft; and (8) challenges in capturing the benefits of innovation, aligning private and public interests.

### **Fragile Supply Chains: Many Inputs, Industry Concentration, and Geographic Concentration**

The supply chains for semiconductor manufacturing are immense. Aside from the immediately apparent inputs such as wafers and photomasks, the manufacturing of semiconductors requires hundreds of chemicals and dozens of gases. A 2018 study of chemical use in two memory device fabrication facilities found they each used over 400 chemical products weighing over 45,000 tons per year.<sup>145</sup> According to NIST, as many as 49 gases alone may be used in semiconductor production.<sup>146</sup> Many of these chemicals have their own extensive supply chains that often originate outside of the United States or may depend on limited or single sources of supply.

While not commonly thought of as manufacturing inputs, assured sources of water and energy are essential to semiconductor manufacturing. One commenter responding to the NOI noted that “a typical semiconductor production facility uses two to five million gallons of water per day.” TSMC recently announced plans to build an industrial water treatment facility to better insulate itself from droughts or other water-related disruptions, aiming to satisfy over 40 percent of the company’s water usage of 156,000 tons per day by 2024.<sup>147</sup>

Energy demands are also high for semiconductor fabrication. Facilities may require as much as 100 megawatt-hours of power each hour of operation,<sup>148</sup> equivalent to the amount of power consumed by the average U.S. household in nine years.<sup>149</sup> With electricity amounting for up to 30 percent of fabrication operating costs, access to reliable and affordable energy is essential for semiconductor manufacturers to be competitive.<sup>150</sup> The sudden cessation of water or electricity into a fab ruins wafers currently in the production line, at a high cost to the manufacturer.

For inputs that can be kept in inventory, efforts to gain cost savings through reduced inventories increase vulnerabilities to supply chain disruptions. While many companies seek multiple suppliers to reduce the risk of disruption, for some items, this may not be possible. As discussed above, many segments of the semiconductor supply chain are highly concentrated, with one or a handful of suppliers dominating a particular process or area of focus. One of the most visible such areas is in photolithography equipment, where only ASML supplies EUV equipment, and the top three providers (ASML, Nikon, Canon) account for virtually all of the overall market share.

The United States leads the world in fabless semiconductor design, which introduces the additional supply constraint of outsourced manufacturing services. As noted above, 80 percent of the foundry market share is located in Asia, nearly all located in Taiwan. With a limited number of potential suppliers of chip fabrication

---

<sup>145</sup> Kim et al. “Chemical use in the semiconductor manufacturing industry”, (*International Journal of Occupational and Environmental Health*, October 24 2018).

<sup>146</sup> Fluid Metrology Group, “Index of Semiconductor Process Gases”, (*National Institute of Standards and Technology*, August 21 2020).

<sup>147</sup> Cheng Ting-Fang, “TSMC tackles Taiwan drought with plant to reuse water for chips”, (*Nikkei Inc*, April 22 2021).

<sup>148</sup> Steve Chen, Apoorv Gautam, and Florian Weig, “Bringing Energy Efficiency to the Fab”, (*McKinsey*, Autumn 2013).

<sup>149</sup> “Use of energy explained: Energy use in homes”, (*U.S. Energy Information Administration*, May 9 2019).

<sup>150</sup> Steve Chen, Apoorv Gautam, and Florian Weig, “Bringing Energy Efficiency to the Fab”

services and severe geographic concentration, a single event such as a natural disaster can result in significant disruption across the supply chain.

Indeed, the globalized and highly specialized structure of the semiconductor manufacturing supply chain, combined with the economic benefits of geographic manufacturing clusters, raises the risks of disruption from natural and human-made disasters. For example, in December 2020, a one-hour long power outage in a memory fab in Taiwan impacted 10 percent of global DRAM supply.<sup>151</sup> In a more recent example, the 2021 cold weather-related power outages in Texas led to short term closures of three chip manufacturing facilities in Austin, further straining supply chains that had been impacted by COVID-19.<sup>152</sup> In addition, following a fire at its facility in March 2021, Japanese chip producer, Renesas Electronics Corporation, said that it would take 100 days for the plant to return to normal production. This further exacerbated the automotive chip shortage because two-third of the output of the impacted production line supplied automotive chips.<sup>153</sup> With East Asia hosting significant concentrations of critical material inputs and manufacturing processes, and U.S. semiconductor manufacturing concentrated in Texas, Arizona, and Oregon, the potential for a single event to have large impacts is heightened.

Domestic manufacture, processing, and distribution of semiconductors and materials and equipment related to semiconductor manufacturing could potentially be impacted by current and future regulations under environmental statutes. Regulated entities, including those in the semiconductor industry, may need to identify specific chemicals in their supply chain and engage in R&D to reduce or replace those chemicals as necessary. Given the complexity and challenges of the supply chain outlined in this document, this could, in some cases, be a significant undertaking. The U.S. Environmental Protection Agency is aware of these issues, including those raised by commenters regarding specific actions under the Toxic Substances Control Act,<sup>154</sup> and has been in constant communication with the semiconductor industry regarding how supply chain impacts can be considered during development of future regulations.

### **Malicious Supply Chain Disruptions: Insertions and Counterfeits**

The risk of malicious disruptions to semiconductors and their supply chains has risen in concert with increased chip complexity, process separation, and outsourcing. According to the Department of Defense's (DoD) Defense Science Board Cyber Supply Chain Task Force, "insertion of a malicious microelectronic vulnerability via the supply chain can occur at any time during production and fielding of a weapons system or during sustainment of the fielded system."<sup>155</sup> The design step is particularly vulnerable to alteration of insertion. Such attacks would not need to be targeted at a particular end user; as designs and IP blocks can be used across millions of chips a modified design could insert a back door across all chips using it, with a malicious actor then able to target the system using the chip, specialized designs for known end-users could be especially vulnerable. The end-user is also easily identified during the fabrication of the specialized photomasks and packaging.

Counterfeiting and re-use of semiconductors presents an additional risk. Beyond the revenue loss experienced by the victims of counterfeits—estimated at \$100 billion annually for the entire electronics sector—systems and end users can experience early or catastrophic failure as a result of counterfeit semiconductors.<sup>156</sup> Defense systems and critical infrastructure are particularly at risk from counterfeits, as these uses often place more stress on components and have more dire ramifications for failure. Inspection,

---

<sup>151</sup> Varas et al. "Strengthening The Global Semiconductor Supply Chain In An Uncertain Era"

<sup>152</sup> Ian King and Bloomberg, "Texas power failures shut down chip factories, which could send shock waves up the supply chain", (Fortune, February 17 2021).

<sup>153</sup> Eimi Yamamitsu, "Renesas says normal production at fire-hit chip plant to take 100-120 days", (Reuters, March 29 2021).

<sup>154</sup> For example, see public comments from Hitachi High-Tech America, Inc. and American Chemistry Council.

<sup>155</sup> Defense Science Board, "Task Force on Cyber Supply Chain", (Office of the Under Secretary of Defense For Acquisition, Technology, and Logistics, April 2017).

<sup>156</sup> Guin et al. "Counterfeit Integrated Circuits: A Rising Threat in the Global Semiconductor Supply Chain", (IEEE, August 2014).

sensing, and monitoring also is at particular risk because a counterfeit semiconductor may not detect failures and problems or may induce mis-calibration of equipment due to faulty readings. The simplest form of counterfeiting in this case is the re-packaging or remarking of a used, mis-branded or not to spec semiconductor. Semiconductor companies have developed sophisticated product markings and other counters to this.

The DoD instituted the Trusted Foundry program in 2003 to focus on assuring the integrity of the semiconductor supply chain for the U.S. Government. To this end, DoD Instruction 5200.44 requires that “In applicable systems, integrated circuit-related products and services shall be procured from a trusted supplier accredited by the Defense Microelectronics Activity (DMEA) when they are custom-designed, custom-manufactured, or tailored for a specific DoD military end use (generally referred to as application-specific integrated circuits (ASICs)).” With no leading-edge semiconductor manufacturers in the United States or other members of the National Technology and Industrial Base,<sup>157</sup> the DoD is currently unable to ensure its access to secure supply chains. Similarly, the Department of Energy’s Argonne National Laboratory’s planned Aurora supercomputer has had to switch from using Intel to TSMC due to Intel’s delays in starting 7 nm production.<sup>158</sup>

### **Use of Obsolete and Generations Old Semiconductors and Related Challenges to Continued Profitability of Companies in the Supply Chain**

Beyond access to leading edge chips for new systems, the United States has significant ongoing requirements for mature node and obsolete semiconductors. Many defense systems in particular are in service for many decades beyond their initial design, and sustainment of these systems requires a continued ability to manufacture and replace parts that are no longer cutting edge. The chips used in the B-2 bomber, for example, were obsolete just seven years after it came into service; replacing the obsolete electrical components ended up costing nearly 40 percent of what it would have cost to replace the entire electrical system.<sup>159</sup> With defense and other critical systems often having lifespans counted in decades and semiconductors doubling in density every two years, U.S. national security can depend on semiconductors that are generations old.

In addition, for consumer applications, there is continued demand for chips that are years removed from leading edge, creating challenges for continued profitability and production of components. For example, mature node chips (those chips with larger line-widths) that are ubiquitous in autos and other electronic devices throughout the electronics ecosystem are severely impacted by the current shortage. These are relatively low-cost processors that carry out tasks within many different types of end-uses, especially microcontrollers.<sup>160</sup> Despite continued demand, the relative cost of building and operating new fabrication facilities focused on older technologies is high and is complicated by the limited supply of semiconductor equipment suppliers for mature node production.

### **Customer Concentration and Geopolitical Factors: Dependence on China and Potential for International Conflict**

While the United States no longer leads the world in semiconductor manufacturing capabilities, it does play a dominant role in the crucial EDA, IP, and SME segments. With much of the world’s semiconductor

---

<sup>157</sup> The National Technology and Industrial Base (NTIB), established by 10 U.S.C. §2500, includes national security and dual-use activities in the United States, Canada, the U.K., and Australia

<sup>158</sup> Odell et al. “Supply Chain Risk in Leading-Edge Integrated Circuits”, (Institute For Defense Analysis, March 2021).

<sup>159</sup> Peter Sandborn, “Trapped on Technology’s Trailing Edge”, (IEEE Spectrum, April 1 2008).

<sup>160</sup> A microcontroller is integrated circuit used for controlling the digital, analog, and memory functions of an electronic system. They are small, versatile, and inexpensive type of semiconductor. Robert Keim, “What Is a Microcontroller? The Defining Characteristics and Architecture of a Common Component”, (All About Circuits, March 25 2019); Song Jung-a and Eleanor Olcott, “Global chip shortage spreads to toasters and washing machines”, (Financial Times, April 24 2021).



manufacturing carried out in Asia, these companies are highly dependent on manufacturing outside the United States for production of their chips. They also substantially rely on sales outside the United States for revenue, which in turn funds continued development of leading-edge chips to maintain their market lead. As noted above, U.S. equipment companies are nearly entirely dependent on non-U.S. sales, with sales to China accounting for an increasingly large percentage. Losing access to these customers in the short run can have permanent effects, as manufacturers redesign their processes based on their equipment suppliers.

U.S. semiconductor companies, particularly equipment providers and EDA suppliers, thus have the potential to be significantly impacted by trade restrictions between the United States and China, with major portions of their revenue at risk of long-term disruption. Based on the Chinese Government's ambitions in regard to the semiconductor industry, these revenue sources may be at risk in the long run regardless, but given that their ability to reinvest in their businesses is immediately dependent on sales to China, their long-term viability is immediately affected by actions that decrease sales. The current dependence of U.S. companies on sales to China, in addition to plans by the Government of China to become a world leader in semiconductor production, represent one of the largest, most concerted risks to the U.S. semiconductor industry. This short-term dependence and long-term vulnerability highlights the importance of a holistic approach to addressing increasing concentration of semiconductor production activities in China. China's plans and actions more fully explored in the "Competitor Actions" section below.

Beyond China's semiconductor-specific plans, it must be noted that the bulk of worldwide state-of-the-art semiconductor fabrication facilities are in territory subject to geopolitical and geological risk. The fact that many fabrication facilities are in China and Taiwan and are owned by entities in these two economies puts the world semiconductor community at great risk from geopolitical actions. Even a minor conflict or embargo could have immediate major disruptions to the United States and long-term implications for U.S. supply chain resilience.

### **Electronics Production Network Effects: Ongoing Erosion of U.S. Microelectronics Ecosystem**

The production of electronics in general, and semiconductors in particular, benefit from so-called "manufacturing clusters." Regional clustering of similar companies provides the companies in the cluster agglomeration benefits via shared infrastructure and suppliers, building a large talent pool for their workforce, and facilitating shared innovation.<sup>161</sup> In establishing itself as the primary immediate customer for semiconductors, China has established a market position that, if unchecked, will allow it increasing power over the global semiconductor industry.

With many of their largest customers already in China, semiconductor companies have an incentive to establish a nearby presence, which in turn serves to increase the attractiveness of setting up a semiconductor-related business there. A 2017 Department of Commerce survey of the U.S. semiconductor industry found that of the companies with suppliers or customers in China, 42 percent also outsourced some design or manufacturing to China, compared to 18 percent of those with no suppliers or customers in China.

One instructive example is the printed circuit board industry, as highlighted in the 2018 DoD report *Assessing and Strengthening the Manufacturing and Defense Industrial Base and Supply Chain Resilience of the United States*:

The case of printed circuit boards likewise highlights the growing risks to the industrial base. The printed circuit board sub-sector provides the substrate and interconnects for the various integrated circuits and components that make up an electronic system. Today, 90% of worldwide printed circuit board production is in Asia, over half of which occurring in China; and the U.S. printed circuit board sub-sector is aging, constricting, and failing to maintain the state of the art for rigid and rigid-flex printed circuit board production capability.

Indeed, one major printed circuit board producer reported to the Department of Commerce in 2016 that it could build a new production bare printed circuit board site in China or the United States for approximately

---

<sup>161</sup> Ryan Donahue, Joseph Parilla, and Brad McDearman, "Rethinking Cluster Initiatives", (Brookings, July 2018).

the same cost, but that the presence of the upstream and downstream supply chain in China made it more logical and profitable to establish the new facility in China. In the same way that it has now become a better business choice to manufacture circuit boards in China even given the same cost basis, the risk to the U.S. semiconductor industry will continue to rise as China accounts for an increasing share of the semiconductor ecosystem.

### **Human Capital Challenges**

The United States has an immediate need for highly skilled workers in the semiconductor industry. A 2017 industry survey by Deloitte and SEMI found that 77 percent of surveyed semiconductor executives thought the industry was facing a critical talent shortage, with another 14 percent expecting a severe talent shortage.<sup>162</sup> A 2017 Department of Commerce survey similarly found that 71 percent of facilities identified “finding qualified workers” as one of their top three expected workforce issues between 2018 and 2022, with nearly half of respondents listing it as their single most pressing workforce issue.

With such intense competition for skilled labor, the U.S. semiconductor industry is highly dependent on immigration, with an estimated 40 percent of high-skilled workers born abroad.<sup>163</sup> Intel and Micron both reported in 2020 that restrictions to immigration were a challenge in hiring and retaining talent, and accordingly a risk to their businesses.<sup>164</sup>

Universities in the United States are a primary attraction for and source of talent for the semiconductor industry. International students in 2020 accounted for approximately 60 percent of enrollment in semiconductor-related graduate programs.<sup>165</sup> As China increasingly seeks out foreign talent, retaining these students in the United States serves to both bolster the domestic semiconductor industry and prevents competitors from acquiring the talent necessary to surpass the United States.

The Semiconductor Research Corporation (SRC) and the industry association SEMI reported in their public comments on the semiconductor supply chain Executive Order Notice of Inquiry their outreach, education and training programs specific to the semiconductor supply chain and recommendations.<sup>166</sup>

### **IP Theft**

In addition to seeking to acquire skilled semiconductor workers, there are indications that, as the Information Technology and Innovation Foundation writes, “the acquisition of foreign semiconductor technology through IP theft has been a key pillar of Chinese strategy.”<sup>167</sup> Multiple Chinese semiconductor companies have been accused of and charged with stealing trade secrets, including by state-owned Fujian Jinhua Integrated Circuit, Co.<sup>168</sup> Illicit pursuit of IP is not limited to China: from 2012 to 2016, an average of just over 100 lawsuits per year involving semiconductor patents were brought before U.S. District Courts, with a similar number of semiconductor-related petitions brought before the Patent Trial and Appeal Board in 2016 via the *inter partes* review procedure (launched in 2012).<sup>169</sup> The semiconductor industry relies on protection of and reasonable access to IP. Semiconductor design and the associated EDA tools are essentially applications

---

<sup>162</sup> Will Hunt and Remco Zwetsloot, “The Chipmakers: U.S. Strengths and Priorities for the High-End Semiconductor Workforce”

<sup>163</sup> Will Hunt and Remco Zwetsloot, “The Chipmakers: U.S. Strengths and Priorities for the High-End Semiconductor Workforce”

<sup>164</sup> Intel Corporation, “Form 10-K”, (U.S. Securities and Exchange Commission, December 26 2020); Micron Technology Inc, “Form 10-K”, (U.S. Securities and Exchange Commission, September 3 2020).

<sup>165</sup> Will Hunt and Remco Zwetsloot, “The Chipmakers: U.S. Strengths and Priorities for the High-End Semiconductor Workforce”

<sup>166</sup> SEMI, “Public Comment 52. SEMI. Kim Ekmark. 04/05/21”

<sup>167</sup> Stephen Ezell, “Moore’s Law Under Attack: The Impact of China’s Policies on Global Semiconductor Innovation”

<sup>168</sup> “PRC State-Owned Company, Taiwan Company, and Three Individuals Charged With Economic Espionage”, (U.S. Department of Justice, November 1 2018).

<sup>169</sup> “Trends in Semiconductor Industry Patent Prosecution and Litigation 2017”, (Jones Day, February 2017).

of IP, and the United States' ability to continue to lead in these areas is dependent on adequate protection of IP.

Related areas of concern are forced technology transfer and IP leakage that results from outsourcing of semiconductor production processes. Within Chinese government plans to promote their semiconductor industry are policies that encourage or require the transfer of IP to China-based businesses, including through joint-venture requirements with Chinese businesses. Increased activity by U.S. semiconductor businesses—as well as the Taiwan- and South Korea-based companies U.S. semiconductor design companies depend on for production—in China may result in an acceleration of transfer of IP from U.S.-based companies to China-based companies.

Aggressive pursuit and defense of IP is reflective of the overall level of competitiveness in the semiconductor industry and importance of maintaining competitive edges. The semiconductor industry is second only to biopharmaceuticals as the world's most R&D-intensive industry; the ability to reap the benefits of R&D spending to enables continued future innovation.<sup>170</sup> The same dynamic exists with capital expenditures, as the costs of building cutting edge fabs is rapidly increasing; Moore's Second Law holds that the cost of constructing a semiconductor fabrication facility doubles every four years. For companies aiming to produce at the cutting edge, failure to capitalize on current technology can result in an inability to invest in future technology.

### **Challenges in Capturing the Benefits of Innovation, Aligning Private and Public Interests**

Under optimal conditions, private companies—particularly ones that do not receive massive state-subsidies—optimizing their individual business conditions will lead to efficient markets and sustainable growth. However, the massive R&D and capital expenditures required to manufacture semiconductors and the speed at which the leading edge advances mean that private incentives and the public interest can easily become misaligned. Multi-billion dollar investments take a minimum of several years to show any return, and rising investment needs decrease the appetite for investment by the private sector, particularly in the face of uncertain demand.

Even with the robust private spending on R&D in semiconductor industry, expenditures are targeted at the “D” side: applied research and product development that have closely hewed to advancing Moore's Law scaling.<sup>171</sup> Many individual firms do not have the risk-tolerance necessary to undertake the long-term, high-rate-of-failure basic research projects that will be necessary to advance radically new chip designs and manufacturing processes to support emerging computing methods.<sup>172</sup> Even in the event of a successful outcome, it is difficult for a single firm to capture all of the economic benefits associated with a breakthrough in fundamental science, making them even less interested to try.<sup>173</sup>

In light of the benefits of clustering and network effects discussed above, an individual decision to cease investing or begin offshoring can have negative effects on the rest of the industry. The decision of GlobalFoundries in 2018, for instance to cease work on 7 nm production was “not based on technical issues that the company faced, but on a careful consideration of the business opportunities the company had with its 7 LP platform as well as financial concerns.”<sup>174</sup> The decision to stop work on 7 nm production may have been the most profitable business decision for GlobalFoundries, but left the United States without any cutting edge foundries for the near term.

---

<sup>170</sup> Stephen Ezell, “Moore's Law Under Attack: The Impact of China's Policies on Global Semiconductor Innovation”

<sup>171</sup> “Winning the Future: A Blueprint for Sustained U.S. Leadership in Semiconductor Technology”, (Semiconductor Industry Association, April 2019).

<sup>172</sup> “The Future of Computing”, (Potomac Institute for Policy Studies, January 2020).

<sup>173</sup> Matt Hourihan and David Parkes, “Federal R&D Budget Trends: A Short Summary”, (American Association for the Advancement of Science, January 2019).

<sup>174</sup> Anton Shilov and Ian Cutress, “GlobalFoundries Stops All 7nm Development: Opts To Focus On Specialized Processes”, (AnandTech, August 27 2018).

This lack of domestic capacity may soon be mitigated by proposed investments in the United States for new fabrication facilities in the United States (discussed below). In the same way that the decision of GlobalFoundries to cease work on 7 nm production limited the options of domestic design companies, unilateral investments by Intel, TSMC, or Samsung in a domestic foundry can have positive ripple effects throughout the semiconductor supply chain.

The broader external impacts of such individual decisions are amplified in the semiconductor manufacturing industry, which is highly consolidated and features significant government intervention, particularly in China. While U.S. companies must typically cut back on hiring, capital expenditures, and R&D when faced with uncertain future demand, companies in China, both with and without direct government ownership, are able to continue to invest based on the knowledge that the Government of China will be contributing billions of dollars to the industry.

## GLOBAL FOOTPRINT

### CHINA

China is implementing a comprehensive strategy to build an indigenous semiconductor sector. The billions of dollars in state-directed subsidies and other financial support given to domestic entities comprise the key pillar of China's overall industrial policy approach since 2014, which aims to indigenize and place under state control or ownership its entire semiconductor supply chain.

China's novel subsidy strategy – primarily in the form of government equity “investments” – aggressively exploits gray areas in international trade rules in World Trade Organization (WTO) disciplines.<sup>175</sup> Government and industry stakeholders across the global semiconductor supply chain are deeply concerned by China's market-distorting behavior. The following is a catalogue of the scale and structure of China's subsidies program, where China is spending its money, and the current and potential impacts of the subsidies.

The government of China declared its desire to build a globally superior, self-sufficient domestic semiconductor industry with its June 2014 publication of the *Guidelines*.<sup>176</sup> China's industrial policy in the semiconductor sector is funded at a magnitude significantly larger than in previous sector development campaigns. “China routinely cranks out economic plans: what counts is not the plan but the money,”<sup>177</sup> meaning that what matters with this policy is not the plan itself, but the amount of money being doled out.

In conjunction with release of the *Guidelines*, China established the National Integrated Circuit (IC) Fund, incorporated as a majority government-owned investment company. Launched in 2014, the first phase of the National IC Fund had as its main shareholders China's Ministry of Finance and the China Development Bank, which held almost 60 percent of the shares combined, while central and local level government state owned enterprises (SOEs) held the vast majority of remaining shares. According to China's National Enterprise and Credit Information Publicity System,<sup>178</sup> the registered capital for the first phase of the National IC Fund was \$21 billion. Announced in October 2019, the second phase of the National IC Fund included \$29 billion and will likely increase.

China's “venture capital” model is designed to funnel massive state subsidies into China's domestic semiconductor industry. By characterizing the National IC Fund as a private, market-driven investment fund

---

<sup>175</sup> WTO Subsidies and Countervailing Measures (SCM) Agreement requires all members to notify all government subsidies to the SCM Committee which are then subject to extensive review to determine, *inter alia*, whether said subsidy is prohibitive and caused injury: “Agreement on Subsidies and Countervailing Measures (“SCM Agreement”); (World Trade Organization, n.d.).

<sup>176</sup> “Ensuring Long-Term U.S. Leadership in Semiconductors”, (President's Council of Advisors on Science and Technology, January 2017).

<sup>177</sup> James Andrew Lewis, “China's Pursuit of Semiconductor Independence”, (Center For Strategic & International Studies, February 27 2019).

<sup>178</sup> “国家职业信用信息公示 National Enterprise Credit Information Publicity System”, (State Administration of Market Supervision and Administration, n.d.).

free from government intervention, China is avoiding the transparency requirements of the WTO subsidy regime and is likely seeking to avoid future WTO dispute settlement. With clear guidance and support from China's central government, this "venture capital" model has been replicated across Chinese provinces and municipalities. The Chinese government has consistently maintained that the investment fund is run on a commercial basis without government interference. However, the reality is that these fund managers, in all likelihood, serve as proxies to carry out the government of China's policy to strengthen indigenous innovation, replace imports and support China's industrial policy and military-civil fusion objectives.<sup>179</sup>

Now that China is eight years into its plan, it is clear that that China's government designed its "venture capital" model to facilitate a massive subsidy campaign to develop its domestic semiconductor capability to avoid any WTO oversight. Indeed, the OECD recently concluded that this "could explain in part the recent proliferation of government funds investing in semiconductor firms, which may allow governments to continue /supporting their domestic industry while limiting the risk of a WTO challenge," obliquely referring to China.<sup>180</sup>

Central government funding also signals where municipal and provincial level officials should invest, thus amplifying the effect of central-level subsidies.<sup>181</sup> The value of subsidies provided by non-central government entities to China's semiconductor industry has been estimated at \$145 billion for the 2015-2025 time frame.<sup>182</sup> Combined, Chinese government support to its domestic industry during this time frame could be as high as \$200 billion, though lack of transparency makes determining the true scale of Chinese government financial support difficult.

In addition to subsidies, Chinese policies have lowered income tax rates for semiconductor companies that use specific technology nodes and there are specific concessions on value-added tax. Several potential domestic champions, including Tsinghua Unigroup (Beijing) and SMIC (Shanghai), have received loans at below-benchmark rates from China's policy banks (e.g. China Development Bank) and the "big four" state-owned banks.<sup>183</sup> Semiconductor sector development is one of China's most well-funded industrial policies, highlighting the seriousness with which China is challenging established global players.

### **Semiconductor Subsidy Support Vectors**

China's support for its domestic semiconductor industry is being implemented in various ways.

In the early stages of implementation, China focused on semiconductor industry mergers and acquisitions. In 2015, China began by funding the consolidation of myriad of domestic companies into larger ones, giving potential "national champions" the scale to compete with foreign companies. The most prominent example was the acquisition of RDA Microelectronics (China) and Spreadtrum (China) by Tsinghua Unigroup. These acquisitions put Tsinghua Unigroup in lead position for China's semiconductor industry development.

In the *Guidelines*, China acknowledged that it could not develop its semiconductor industry without foreign assistance and technological expertise and therefore emphasized the importance of international engagement. For example, the *Guidelines* provided the objective to "further improve the [semiconductor] development environment, vigorously attract foreign capital, technology and talent; encourage international IC companies to establish R&D, manufacturing and operations in China." Armed with billions in subsidies, the Chinese government went on a buying spree for foreign semiconductor companies. Globally China went from zero semiconductor company acquisitions prior to 2014 to over 25 potential and completed deals in 2015. This

---

<sup>179</sup> Dieter Ernst, "China's Bold Strategy For Semiconductors--Zero-Sum Game Or Catalyst For Cooperation?", (East-West Center, September 2016).

<sup>180</sup> OECD, "Measuring distortions in international markets: The semiconductor value chain"

<sup>181</sup> OECD, "Measuring distortions in international markets: The semiconductor value chain"

<sup>182</sup> According to SIA estimates of publicly available information. Poor transparency makes the true scale of financial support challenging to predict

<sup>183</sup> OECD, "Measuring distortions in international markets: The semiconductor value chain"

does not include the more than a dozen unrecorded and informal approaches that took place during this period.<sup>184</sup>

Talent recruitment is another focus in China's semiconductor strategy. Under its "Thousand Talents Plan," China aims to recruit top science and engineering experts from abroad to support Made in China 2025.<sup>185</sup> This has been evident in the semiconductor sector as China has poached semiconductor engineers from across the world, with a particular focus on South Korea and Taiwan. China is targeting two groups of engineers: senior industry veterans in their 40s and 50s who have in-depth knowledge of current manufacturing processes and very young talent just out of university. For example, in South Korea there are reports of successful use of "1/5/3" recruiting tactics to entice local talent – industry veterans are offered five times their salary for three years of work if they accept employment in China.<sup>186</sup> China has also reportedly lured away 3,000 Taiwanese chip engineers over the past several years by offering two to three times their current salary.<sup>187</sup> Paying above-market rates for industry talent is another example of China's aggressive behavior supported by state subsidies.

A large proportion of Chinese subsidies in the semiconductor sector are going towards construction of Chinese fabs. Modern fabs are expensive to build and equip (\$12-\$20 billion) and extremely complex to operate. Consequently, since 2014, the Chinese government has played a central role in co-financing a domestic semiconductor fab building boom through complex ownership structures that involve local and central government funds as well as certain SOEs. Increasing domestic fab capacity is a hallmark of China's industrial policy to achieve its goal of self-reliance in the semiconductor sector. In 2018, China alone accounted for more than half of worldwide construction spending on fabs, reaching \$6.2 billion.<sup>188</sup> In 2019, total announced Chinese investments in fabs exceeded \$215 billion. Industry estimates that government-financed fabs in China could number 70 or more by 2023 compared with roughly two dozen now.<sup>189</sup> The Chinese government is also ensuring that the pace of China's semiconductor fab construction moves ahead unimpeded. Signaling the Government's resolve, the National IC Fund recently pledged to commit further capital to projects during the COVID-19 outbreak in China, including the YMTC 3D-NAND flash memory fab in Wuhan.<sup>190</sup>

There is an expanding global demand for memory chips and China hopes to use lessons from developing this technology as a stepping stone to produce more sophisticated products, as Japan and South Korea did in the 1980s and 1990s.<sup>191</sup> China understands that emerging applications and technologies will require unparalleled memory capabilities. Its strong push into memory is a strategic move to achieve its ultimate goal of cyber sovereignty and establishing first-mover advantage in "new generation information technology."

China's memory projects are the most mature of all its efforts across the semiconductor spectrum. YMTC, a subsidiary of Tsinghua Unigroup, is emerging as China's national champion memory chip producer. Even though YMTC's 3D-NAND memory technology is untested and significantly less advanced than global leaders, it still represents a watershed moment in China's semiconductor ambitions, especially because YMTC

---

<sup>184</sup> Thilo Hanemann and Daniel H. Rosen, "Chinese Investment in the United States; Recent Trends and the Policy Agenda", (Rhodium Group, December 9 2016).

<sup>185</sup> Kathrin Hille, "US fears attempts by Chinese chipmakers to grab top talent", (Financial Times, November 2 2018).

<sup>186</sup> Blouin et al. "2016 Top Markets Report Semiconductors and Related Equipment", (U.S. Department of Commerce, International Trade Administration, July 2016).

<sup>187</sup> Keoni Everington, "China poaches 3,000 chip engineers, but Taiwan winning from trade war", (Taiwan News, December 3 2019).

<sup>188</sup> James Andrew Lewis, "China's Pursuit of Semiconductor Independence"

<sup>189</sup> OECD, "Measuring distortions in international markets: The semiconductor value chain"

<sup>190</sup> Ahmad et al. "Semicon China 2017", (Credit Suisse, March 22 2017).

<sup>191</sup> James Andrew Lewis, "China's Pursuit of Semiconductor Independence"

was only founded in July 2016. YMTC has received an estimated \$24 billion in subsidies from Chinese government sources, which was essential to the firm's rapid development.<sup>192</sup>

## China National IC Fund Phase II

Undeterred by foreign competitors' and governments' complaints about the market-distorting effects of its subsidies<sup>193</sup> as well as U.S. export restrictions of advanced semiconductor technology and machinery that may assist Chinese companies, China is accelerating its industrial policy. As illustrated above, China is signaling its commitment to the development of its semiconductor industry and confidence that these policy tools are working despite at least six multi-billion dollar semiconductor projects in China utilizing state funds failing over the past two years,<sup>194</sup> on-going overinvestment in China's domestic IC market,<sup>195</sup> and the fact that even state champion Tsinghua Unigroup is struggling to meet its debt obligations.<sup>196</sup> Announced in late 2019, the second phase of the National IC Fund is largely the same as the original, but looks to support the indigenization of a broader swathe of the semiconductor supply chain, including SME as discussed above. The second phase also includes sharp increases in the amount of funds from local governments, especially from the southwest provinces. Genuine private-sector investment is almost non-existent.<sup>197</sup>

Ding Wenwu, President of the National IC Fund (former Director of Electronic Information Division in the China's Ministry of Industry and Information Technology), announced that, while the first phase was focused "almost exclusively on manufacturing projects, phase two will increase the proportion of investment in the IC design industry, IC equipment and materials, and will also focus on *subsidizing the adoption of domestic ICs by Chinese electronics companies.*"<sup>198</sup> He highlighted China's design weaknesses in advanced chips, such as CPUs, GPUs, FPGAs, and microelectromechanical systems (MEMS). Through mastery of these types of chips, China aims to dominate emerging industries, including autonomous vehicles, smart grid, IoT, 5G and AI, which could address its strategic technology gap with the United States.

## SOUTH KOREA

South Korea plays a major role in the global semiconductor supply chain. In 2019, South Korea-based companies accounted for nearly 20 percent of global sales, second only to the United States. This market share is predominantly represented by Samsung and SK hynix. It also has a small but consistent role in the manufacture of semiconductor manufacturing equipment.

Given the predominance of Samsung and SK hynix in the global supply chain, most South Korean Government support, while limited, is provided to those two firms. From 2014-2018, the South Korean Government provided a total of \$8 billion to Samsung and less than \$1 billion to SK hynix, representing less than one percent of revenue for both companies mostly through R&D support and tax concessions.<sup>199</sup> Most recently, the South Korean Government announced two programs aimed at improving the semiconductor workforce and artificial intelligence (AI) chips.

---

<sup>192</sup> Cheng Ting-Fang, "China's top maker of memory chips plans to double output in 2021", (Nikkei Inc, January 12 2021).

<sup>193</sup> According to Taiwan News, there were approximately 45,300 companies in China supposedly dedicated to chip production or design as of July 20, 2020. Sophia Yang, "Six of China's largest semiconductor projects now halted", (Taiwan News, October 5 2020).

<sup>194</sup> Emily Feng, "A Cautionary Tale For China's Ambitious Chipmakers", (National Public Radio, March 25 2021).

<sup>195</sup> Nuying Huang and Willis Ke, "China moving to prevent blind investment in third-generation semiconductors", (DigiTimes, December 28 2020).

<sup>196</sup> Josh Horwitz, "Analysis: China's would-be chip darling Tsinghua Unigroup bedevilled by debt and bad bets", (Reuters, January 19 2021).

<sup>197</sup> Xinzhiyun Rurouni Sword, "芯智讯 注册资本2041.5亿·大基金二期来了!", (Weixin, October 25 2019).

<sup>198</sup> "丁文武解读大基金二期规划·将布局哪些新兴行业", (EEFocus, March 19 2018).

<sup>199</sup> OECD, "Measuring distortions in international markets: The semiconductor value chain"

Samsung produces a wide array of semiconductor products and its competitive advantage lies in logic, memory, and image sensors. In 2020, Samsung was rated the second leading semiconductor company by sales, just behind Intel, driven primarily by memory and leading edge logic.<sup>200</sup> Samsung is one of only two companies that are producing volume in the leading edge 7 nm and 5 nm chips. The firm is using its manufacturing and technology edge to push its manufacturing capacity, thus further cementing its growing leadership over other rivals. In 2020, Samsung was ranked number one in total global 300 mm capacity at 21 percent.<sup>201</sup> Samsung continues to make significant investments to increase its production capacity and is forecasted to spend an additional \$30 billion in 2021.<sup>202</sup>

South Korea's dominant market share is also driven by South Korean companies' strong memory business. In 2019, Samsung was the global market share leader in DRAM (46 percent) and NAND flash (35 percent).<sup>203</sup> SK hynix is also a dominant player in the memory market with 29 percent of the DRAM and 10 percent of the NAND Flash market during the same timeframe. In 2019, strong memory sales and rising prices helped Samsung and SK hynix take the number two and four spots, respectively, for top global semiconductor firms by revenue.<sup>204</sup>

The Government of Korea provides several types of incentives to support its domestic semiconductor-manufacturing base. Not only does the Korean Government provide subsidies to lower the cost of infrastructure development and utilities, but it also supports semiconductor companies by identifying and providing favorable locations for new fabs. In addition, the government has enacted simplified or expedited procedures and has eased regulations to lower administrative burdens on the South Korean semiconductor industry. According to one source, incentives and subsidies provided by the Government of Korea effectively lower the total cost of ownership of a semiconductor fab by approximately 25-30 percent.<sup>205</sup>

## **EUROPEAN UNION (EU)**

In December 2020, 20 EU member states signed a joint declaration to work together to "reinforce the processor and semiconductor ecosystem and to expand industrial presence across the supply chain." The declaration states its aims as "creating synergies among national research and investment initiatives" and building and expanding upon existing microelectronics projects. The Declaration notes a requirement of investments from the EU budget, national budgets, and the private sector. Microelectronics was identified as a key area for investment under the EU Recovery and Resilience Facility. In its March 2021 release of a new "Digital Compass," the EU Commission has called for Europe to account for 20 percent of global production by value of "cutting-edge and sustainable semiconductors" by 2030. The announcement of the new Digital Compass promised investments from the EU budget to support its goals, including support from the Recovery and Resilience Facility. The EU Commission has set aside \$173 billion to support member states' digital infrastructure projects in its 2021-2027 budget. Also of note is the industry-academic consortia IMEC,<sup>206</sup> with two state-of-the-art cleanrooms and one 200 mm, advanced packaging equipment and 4,000 employees. Industry supplies 80 percent of the funding, and 20 percent by the local government. There are also regional efforts such as Silicon Saxony.<sup>207</sup>

---

<sup>200</sup> "Intel to Keep Its Number One Semiconductor Supplier Ranking in 2020", (IC Insights, November 23 2020).

<sup>201</sup> "TSMC Ranks in Top-10 For Capacity in Three Wafer Size Categories", (IC Insights, February 24 2021).

<sup>202</sup> Kotaro Hosokawa, "Samsung to pour \$30bn into booming chip business", (Nikkei Inc, January 9 2021).

<sup>203</sup> Cheng Ting-Fang and Lauly Li, "China memory chip output zooms from zero to 5% of world total", (Nikkei Inc, November 20 2019).

<sup>204</sup> Kim Eun-Jin, "Samsung Electronics Tops Global NAND Flash Market in 4Q20 with 32.9% Share", (Business Korea, March 5 2021); Yonhap, "Samsung's presence in DRAM market slightly down in Q1: report", (The Korea Herald, May 12 2021).

<sup>205</sup> Note: different sources report varying levels of support provided by other governments: Varas et al. "Government Incentives and US Competitiveness in Semiconductor Manufacturing".

<sup>206</sup> "About Imec", (IMEC, n.d.).

<sup>207</sup> Silicon Saxony, "About Silicon Saxony", (SiliconEurope, n.d.).



## JAPAN

In response to the COVID-19 global pandemic, under a program approved by Japan's National Diet, the Ministry of Economy, Trade, and Industry allocated \$2.8 billion to support Japanese companies moving manufacturing capacities with an overreliance on one country (e.g., China) back to Japan or to Southeast Asian countries.<sup>208</sup> Subsidies initially targeted the costs of shifting production for medical products in short supply, and subsequent rounds target critical technology and green goods.<sup>209</sup> In addition, recent press reports indicate that additional support for semiconductor manufacturers will be included in an economic growth strategy developed by the Government of Japan.<sup>210</sup>

## TAIWAN

In Taiwan, current incentives for semiconductor companies included 50 percent for land costs, 45 percent for construction and facilities and 25 percent for semiconductor manufacturing equipment.<sup>211</sup> Science parks sponsored by the Taiwan authorities provide semiconductor companies with access to land, electricity, and water and lower operating costs by enabling several members of the semiconductor supply chain to operate within the same facility. In total, according to one source, these incentives and subsidies effectively lower the total cost of ownership of a semiconductor fab by approximately 25-30 percent.<sup>212</sup> Other amenities at industrial parks include land for lease only, transportation infrastructure, no commercial or business taxes for machines used for production, raw materials, fuel, or semi-finished products, grants for industry-academic cooperation programs, reduction in R&D taxes, and a one-stop shop for services including talent cultivation, R&D grants application and customs services.<sup>213</sup>

In addition, in June 2020, Taiwan announced a \$1.3 billion annual fund to attract foreign companies to establish semiconductor R&D projects in Taiwan, subsidizing up to half of all R&D costs incurred by global chip companies that build a presence on the island.<sup>214</sup> It also announced that the government would invest \$335 million to incentivize foreign companies to establish semiconductor R&D facilities in Taiwan. The program aims to subsidize half of all R&D costs incurred by global chip companies that build on the island.<sup>215</sup> In addition, Taiwan authorities announced small-scale programs focused on AI applications.<sup>216</sup>

To combat China's efforts on attracting semiconductor engineers and designers, Taiwan has a law prohibiting Chinese firms from conducting business activities—including recruitment—without prior approval from the Taiwanese authorities.<sup>217</sup> In March 2021, Taiwanese prosecutors relied on this law to investigate accusations that Beijing-based Bitmain had established front companies in Taiwan to poach semiconductor designers.<sup>218</sup>

## SINGAPORE

In Singapore, the total cost of ownership of an advanced memory fab is approximately 21 percent lower than it would be in the United States, with 63 percent of this gap attributed to government incentives provided to

---

<sup>208</sup> Yuko Takeo, Emi Urabe, "Japan Allocates \$2.4 Billion to Beef Up Supply Chains", (Bloomberg, November 20 2020).

<sup>209</sup> "Successful Applicants Selected for the Program for Promoting Investment in Japan to Strengthen Supply Chains", (Government of Japan: Ministry of Economy, Trade, and Industry, November 20 2020).

<sup>210</sup> Rieko Miki, Takashi Tsuji, and Kosuke Takeuchi, "Japan to pour cash into domestic chipmaking, following US and China", (Nikkei Inc, May 19, 2021).

<sup>211</sup> Varas et al. "Government Incentives and US Competitiveness in Semiconductor Manufacturing"

<sup>212</sup> Varas et al. "Government Incentives and US Competitiveness in Semiconductor Manufacturing"

<sup>213</sup> "Why Hsinchu Science Park", (Hsinchu Science Park Bureau, Ministry of Science and Technology, November 30, 2020).

<sup>214</sup> Debby Wu and Cindy Wang, "Taiwan Draws Up Plan to Woo \$1.3 Billion of Annual Tech Research", (Bloomberg, July 4 2020).

<sup>215</sup> Debby Wu, "Taiwan Dangles \$335 Million to Woo Foreign Chipmakers", (Bloomberg, June 3 2020).

<sup>216</sup> Taiwan Today, "MOST unveils plan for AI research centers", (Ministry of Foreign Affairs Republic of China (Taiwan), July 7 2017).

<sup>217</sup> Debby Wu, "Taiwan Probe Spurs Fears of China Poaching Top Chip Talent", (Bloomberg, March 9 2021).

<sup>218</sup> Kathrin Hille, "Taiwan accuses Bitmain of poaching its top chip engineers", (Financial Times, March 10 2021).

semiconductor companies. These incentives include significant subsidies that lower land procurement and development costs. In addition, the government supports special economic zones and science parks, enabling other members of the semiconductor supply chain to operate within the same facility as the fab that they support. In total, according to one source, these incentives and subsidies effectively lower the total cost of ownership of a semiconductor fab by approximately 25-30 percent.<sup>219</sup>

## **ISRAEL**

While Israel currently lacks significant semiconductor manufacturing capacity, the Government of Israel provides strong incentives and subsidies to encourage the development of its semiconductor-manufacturing base. These incentives include subsidies on land development, facility construction, and equipment procurement. In total, according to one source, government incentives effectively lower the total cost of ownership of a semiconductor fab by approximately 30 percent.<sup>220</sup>

## **OPPORTUNITIES & CHALLENGES**

### **Opportunity: Foster Investment in Domestic Semiconductor Manufacturing**

As noted earlier, the U.S. share of semiconductor production and manufacturing capacity has fallen from 37 percent 20 years ago and stands at about 12 percent (by total capacity wafers per month) of global production. U.S. companies, including major fabless semiconductor companies, depend on foreign sources for semiconductors, especially in Asia, creating an obvious supply chain risk. Also, of concern is the fact that the U.S. semiconductor industry does not currently build high volume cutting edge integrated circuits in the United States but relies on Taiwan to manufacture these leading-node semiconductors. These cutting-edge chips are the foundation of paradigm-shifting technologies, such as AI and 5G, which have been identified by DoD as national security priorities. The United States also relies on foreign sources for materials.

To address these concerns, the U.S. Government has an opportunity to promote investment in domestic semiconductor manufacturing facilities as well as manufacturing of key inputs for semiconductors. There is promising evidence that this is already happening: TSMC, Samsung, Intel, and GlobalFoundries have all announced proposals for investments in semiconductor manufacturing operations in the United States.

- TSMC announced plans last year to build an advanced chip foundry in the Phoenix, Arizona area, a \$12 billion investment with completion scheduled in 2024.<sup>221</sup> The plant will produce 5 nm chips with a capacity of 20,000 wafers per month and will employ 1,600 workers.<sup>222</sup>
- Samsung is considering a \$17 billion investment to expand its production capacity in the United States, which would create 3,000 additional jobs<sup>223</sup> and is expected to commence operations in 2023.<sup>224</sup> Technical details on the plant expansion are unclear; one report indicates that the facility would be capable of producing at the 3 nm node. The company is seeking a 20-year property tax reimbursement to locate in Austin, Texas and has stated it is also considering locations in the United States (Arizona and New York) and in South Korea.

---

<sup>219</sup> Kathrin Hille, “Taiwan accuses Bitmain of poaching its top chip engineers.”

<sup>220</sup> Varas et al. “Government Incentives and US Competitiveness in Semiconductor Manufacturing.”

<sup>221</sup> “Chipmaker TSMC eyeing expansion of planned Arizona plant –sources”, (Reuters, May 4 2021).

<sup>222</sup> “TSMC Announces Intention to Build and Operate an Advanced Semiconductor Fab in the United States”, (TSMC, May 15 2020).

<sup>223</sup> Tribune News Service, “Samsung seeks \$1 billion in tax breaks to build new \$17 billion chip plant in Austin”, (The Dallas Morning News, February 5 2021).

<sup>224</sup> Sohee Kim and Ian King, “Samsung Considers \$10 Billion Texas Chipmaking Plant, Sources Say”, (Bloomberg, January 22 2021).

- Intel announced in March 2021 that it will invest \$20 billion to expand its manufacturing capacity through construction of two new fabs at its Chandler, Arizona campus. The fabs will not only serve Intel's requirements but will also provide foundry capacity for fabless customers. The investment is expected to create 3,000 permanent, high wage jobs.<sup>225</sup>
- GlobalFoundries is seeking federal and state support in the form of subsidies or incentives to build a fab adjacent to its existing fab (Fab 8) in Malta, New York. Fab 8 recently implemented export control security measures to allow for the manufacturing of 12 nm devices subject to the International Traffic in Arms Regulations or the Export Administration Regulations.<sup>226</sup>

Not only would increasing domestic semiconductor production capacity help address supply chain vulnerabilities in all segments of the semiconductor supply chain, it could also be the source of high quality, high paying jobs. SIA has estimated that each direct job in the semiconductor industry generates four to five indirect jobs. In addition, expanding production in the United States would help ensure that to maintain a domestic core of trained workforce. Absence of production at the cutting edge can lead to a lack of experience among American engineers working at the cutting edge, risking the U.S. lead in design expertise.

A semiconductor production facility could also support jobs in upstream and downstream sectors – such as electronic materials and packaging and testing. Electronic materials manufacturers already have production facilities in the United States; increased semiconductor production will encourage additional capacity and jobs in these and other critical steps in the supply chain. Several responses to the NOI were from current suppliers to semiconductor fabrication facilities outside the United States, and indicated that they would be interested in establishing U.S. locations to support new domestic fabrication facilities.<sup>227</sup>

In addition, as noted above, the United States also lacks back end chip processing capacity— ATP. This phase of the semiconductor production process is less technologically demanding than fabricating the chip, and the barriers to entering this sector are lower. It is nonetheless a vital step in the chip manufacturing process and an area in which China has both capability and market share and thus ability to willfully or accidentally interrupt supply chains. Government policies to incentivize advanced chip packaging and testing in the United States could also enhance supply chain resilience. These incentives could be targeted at marginalized or economically depressed communities, which are not reaping the benefits of newly announced planned investments in chip production. Most production is in the Austin, Texas and Phoenix, Arizona areas—already technologically prosperous regions.

The Small Business Administration (SBA); several Department of Commerce bureaus, including the Economic Development Administration, Minority Business Development Agency, and NIST Manufacturing Extension Partnership program; and the Export-Import Bank of the United States (EXIM) all have programs, expertise, and resources that could be utilized to achieve the goal of expanding domestic production of semiconductors.

### *Challenges*

The biggest challenge to increasing domestic semiconductor production is cost, both absolute and relative to other countries as discussed in the “Fabrication” and the “Competitor Actions” and “Ally/Partner Country Actions” sections. A large volume 300mm fab anywhere in the world can cost billions of dollars, and tens of billions for a leading edge fab. The most critical factors for determining the best location to manufacture semiconductors include synergies with an existing semiconductor ecosystem/footprint, access to skilled talent, protection for intellectual property, labor costs, and government incentives. While the United States

---

<sup>225</sup> “Intel Announces \$20 Billion Investment for Two New Arizona Fabs”, (Intel Corporation, March 23 2021).

<sup>226</sup> “GlobalFoundries to Implement ITAR and Strict Security Assurances at its Advanced U.S. Semiconductor Manufacturing Facility”, (GlobalFoundries, May 20 2020).

<sup>227</sup> Bureau of Industry and Security, “86 FR 14308 Semiconductor Manufacturing and Advanced Packaging Supply Chain NOI published 3-15-21\_comments due 4-5-21”, (Regulations.gov, March 15 2021).

fares well on the first three factors, the costs of labor are higher and there have been significantly fewer government incentives. As a result, the 10-year cost of a new fab in the United States may be 30 percent—\$6 billion on average—higher than building the same fab in Taiwan, South Korea or Singapore, and up to 50 percent higher than in China. Much of the cost differential (estimated 40-70 percent) is specifically due to government incentives.<sup>228</sup>

Given the fact that global demand for semiconductors is forecast to grow, resulting in a need for an increase in semiconductor manufacturing capacity of more than 50 percent between 2020 and 2030, there is an opportunity for the U.S. to regain a higher share of fab capacity.

### **Opportunity: Maintain and Advance U.S. Leadership in Semiconductor Technologies through R&D**

The United States has led the world in semiconductor innovation, driving transformative advances in nearly every modern technology from computers to mobile phones to the Internet itself. While the U.S. semiconductor design ecosystem is robust and world leading, this segment of the supply chain faces a number of challenges as discussed above. Specifically, the U.S. design ecosystem is robust and world leading, but depends on limited sources of IP, labor, and manufacturing that are essential to bring products to market as well as continued ability to make significant R&D investments. This section focuses on R&D-related opportunities.

The U.S. Government can and must play a vital role in sustaining U.S. leadership in semiconductor technology through supporting R&D and address areas in which there are shortcomings. Federal investments in semiconductor-related research has the potential to add significantly to U.S. gross domestic product and create thousands of high-quality jobs.

Federal scientific and research agencies, including DARPA, the National Labs and NIST, can take the lead on building public-private partnerships and consortia to advance semiconductor innovations across the spectrum of scientific fields—materials, designs, architecture, and manufacturing technology. Market failures in private funding for basic science research have meant that disruptive technology breakthroughs are more commonly associated with government research programs and federally funded academic studies.<sup>229</sup> In addition, according to industry, public/private partnerships connect industry, academia and government and keep industry members updated with novel ideas and discoveries, and new materials, from around the world. However, they are not as successful in translating these technologies to the industrial production phase.

The importance of maintaining U.S. semiconductor leadership and the potential for U.S. government labs to leverage their technological expertise in this regard has been increasingly recognized in bipartisan legislation, such as the CHIPS Act. A broad, well-coordinated, well-funded federal initiative can build upon this growing consensus.

The United States could further explore semiconductor-related R&D opportunities with key partners, such as Taiwan, Europe, Japan, and South Korea, with which the United States has existing Science and Technology agreements. Pooling resources of multiple nations could help boost R&D investments and diversify the risk of investments across multiple countries. An example of a successful multinational R&D effort was EUV technology and equipment, which involved U.S., Japanese, and European participation over the course of three decades.

#### *Challenges*

Funding is a major challenge to developing next generation semiconductor technologies. Semiconductor design and production are already highly sophisticated and take place at the subatomic level. Technology advancements are pushing against the barriers of physics, and breakthroughs to move beyond current limits will involve massive costs. For this reason, it is vital that there be a broad partnership of government, industry and academia to work together to achieve these goals, as it is increasingly difficult for companies to

---

<sup>228</sup> Varas et al. “Government Incentives and US Competitiveness in Semiconductor Manufacturing”

<sup>229</sup> Matt Hourihan and David Parkes, “Federal R&D Budget Trends: A Short Summary.”

do so alone. U.S. investments in semiconductor-related research will need to be increased significantly over current levels. Research is critical to advancing semiconductor design, and federal investment in semiconductor research accounts for only a small fraction of total R&D. In contrast, other governments – including China – are increasing their research investments.

Another challenge will be to ensure coordination among the various federal players (and private sector participants) to minimize duplication of effort and maximize potential return on investments.

**Opportunity: Create Pathways to Support Domestic Semiconductor Jobs along the Supply Chain**

The semiconductor industry provides employment opportunities at all levels, from scientists and engineers to manufacturing workers. Expansion of domestic semiconductor production and maintaining its technological edge will require a robust domestic workforce. There are opportunities, in both direct and indirect jobs, for workers with an Associate's degree or less. Some of these opportunities will require specialized training through apprenticeships, and career and technical education programs.

The lion's share of direct jobs, particularly in leading edge production, require Bachelor's degrees or advanced degrees and pay upwards of \$170,000 annually.<sup>230</sup>

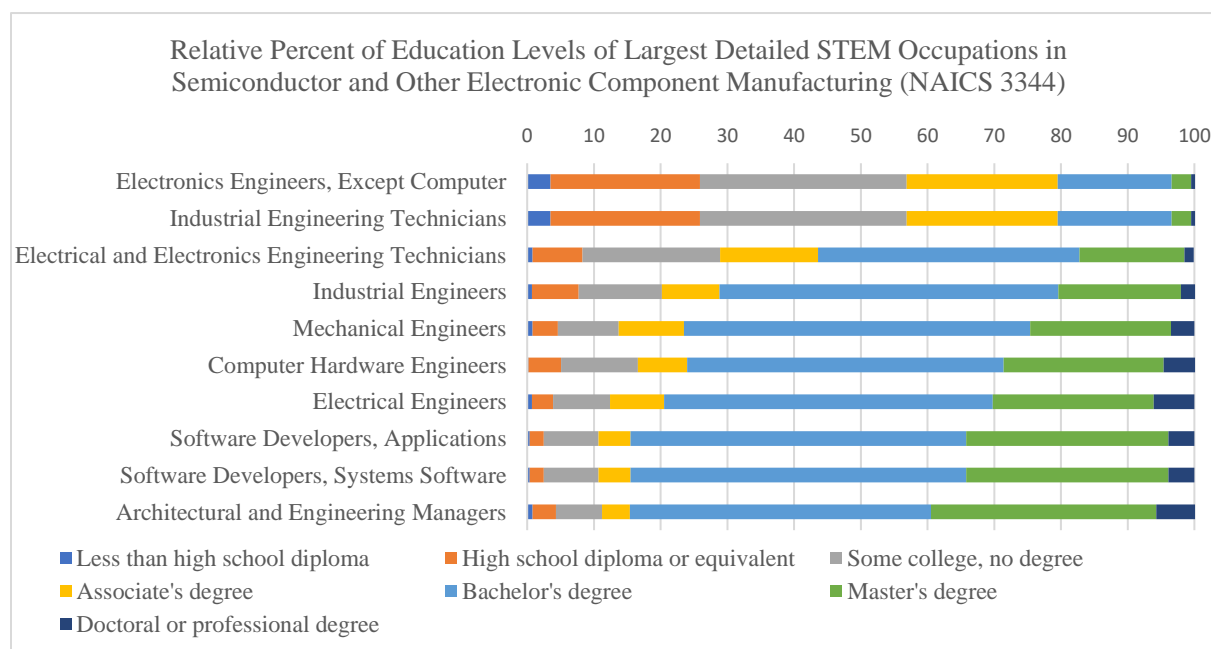

Source: 2015 and 2016 American Community Survey Public Use Microdata, U.S. Department of Commerce<sup>231</sup>

Manufacturing jobs include electrical technicians, assemblers, testers, mechanics, and front-line supervisors. These jobs may be well-suited to registered-apprenticeship and community college programs. Semiconductor companies, working with community colleges, can develop production-line specific training programs that will benefit industry, local communities, and individuals. A share of the training programs, employment opportunities, and semiconductor production jobs should be available to traditionally underrepresented populations and in economically depressed or deindustrialized regions of the country.

To better prepare students for postsecondary programs, companies can also collaborate with career and technical education (CTE) programs at the state and local levels to develop technical preparation programs.

<sup>230</sup> “Chipping in to support stronger U.S. job growth.”, (Semiconductor Industry Association, May 2021).

<sup>231</sup> 2015 and 2016 American Community Survey Public Use Microdata, U.S. Department of Commerce, U.S. Census Bureau, Table 1.11 Educational attainment for workers 25 years and older by detailed STEM occupation, 2015-2016, Data collected for largest populated STEM occupations in NAICS 3344.

Most CTE programs are available to all high school students in a school or district and develop the academic, technical, and employability skills to prepare students to succeed in the workforce and postsecondary education.

Construction of new fabs creates jobs for skilled construction labor. If the CHIPS Act were fully funded, fab expansion, upgrades and construction is expected to create more than 22,000 jobs. Further, the investment is projected to create tens of thousands of indirect jobs.<sup>232</sup>

Overall, industry analysis suggests 1 in 5 jobs in the industry do not require a college degree.<sup>233</sup> However, as fab tools and processing become increasingly advanced, manufacturing jobs increasingly require lengthy education and training investments. Leading edge fabs are largely dependent on workers with Bachelor's degree or higher. Proprietary data suggest 75 to 90 percent of the workforce in leading edge fabs holds a Bachelor's degree or higher, with 50 to 60 percent of engineers holding advanced degrees.

The U.S. holds advantages in the high-skilled workforce. Universities are already strong in technical fields, including microelectronics, and the U.S. National Labs are world class. Many of these institutions rely on foreign-born students and workers.

### *Challenges*

The United States has an immediate need for highly skilled workers in the semiconductor industry and increased investments in leading edge production will increase this need. There is a particular shortage of electrical engineers, one of the largest categories of semiconductor workers. A 2017 industry survey by Deloitte and SEMI found around 60 percent of respondents identified difficulty filling open Electrical Engineering positions. Other positions identified as difficult to fill included Computer Scientists, Software Engineering, Mechanical Engineering, Computer System Engineering, Materials Science & Chemicals.<sup>234</sup>

The U.S. has relied on foreign-born workers to fill many of these gaps. More broadly, 40 percent of high-skilled workers in the U.S. semiconductor industry are born abroad.<sup>235</sup> Many students pursuing these degrees within U.S. institutions are foreign born, especially in advanced degrees. International students in 2020 accounted for approximately 60 percent of enrollment in semiconductor-related graduate programs.<sup>236</sup>

---

<sup>232</sup> Note: U.S. Department of Commerce analysis incorporates EPI statistics, see: Josh Bivens, "Updated employment multipliers for the U.S. economy", (Economic Policy Institute, January 23 2019).

<sup>233</sup> "Chipping in to support stronger U.S. job growth." 2021. Semiconductor Industry America.

<sup>234</sup> Mark Lapedus, "Engineering Talent Shortage Now Top Risk Factor", (Semiconductor Engineering, February 25 2019).

<sup>235</sup> Will Hunt and Remco Zwetsloot, "The Chipmakers: U.S. Strengths and Priorities for the High-End Semiconductor Workforce"

<sup>236</sup> Will Hunt and Remco Zwetsloot, "The Chipmakers: U.S. Strengths and Priorities for the High-End Semiconductor Workforce"

Discipline	Bachelor's degrees		Master's degrees		Doctoral degrees	
	Total recipients	Percent foreign	Total recipients	Percent foreign	Total recipients	Percent foreign
Computer and Information Sciences/Programming/Computer Systems Analysis	56,090	8%	33,437	73%	1,752	59%
Electrical, Electronics, and Communications Engineering/Computer Engineering	28,645	12%	18,787	74%	2,686	48%
Mechanical Engineering/Mechatronics	35,780	9%	8,542	53%	1,507	56%
Physics/Engineering Physics	8,508	8%	2,006	38%	1,909	45%
Chemistry/Chemical Engineering/Materials Science/Materials Engineering	28,903	8%	5,650	44%	4,761	42%
<b>Total</b>	<b>157,926</b>	<b>9%</b>	<b>68,422</b>	<b>67%</b>	<b>12,615</b>	<b>48%</b>

Source: CSET analysis of 2016–17 Integrated Postsecondary Education Data System (IPEDS).

By dramatically increasing demand for trained workers, the CHIPS Act provisions will likely create an immediate call from industry for more foreign-born students and workers. Electrical engineers are expected to be in high demand across a range of industries in the United States, and new engineers require substantial academic and on-the-job training. The CHIPS Act provisions, however, also create an opportunity, if not an impetus, for bringing semiconductor manufacturers together to solve jointly the most acute skills shortages that they face. The current geographic concentration of semiconductor manufacturing, principally in Arizona, California, Oregon, and Texas, could facilitate collaboration to identify common skills needs and pathways. Constructing new semiconductor factories is multiyear endeavor and in parallel the companies could establish education and training programs needed to prepare U.S. workers and address the significant under-representation of African Americans, Latinos and women in semiconductor technology fields.

Workers with science, technology, engineering, and math (STEM) degrees are highly coveted in the U.S. labor market, with the country having among the highest diversion rates of STEM graduates in the world. Even many U.S. electrical engineering students, for example, will take jobs outside of the field, such as in consulting or banking. Hiring foreign-born, U.S.-trained electrical engineers and other STEM workers is one option to ensure hiring challenges do not undermine an expansion supported by the CHIPS Act provisions. Furthermore, as China increasingly seeks out foreign talent, retaining these students in the United States serves to both bolster the domestic semiconductor industry and prevents competitors from acquiring the talent necessary to surpass the United States. Intel and Micron both reported in 2020 that restrictions to immigration were a challenge in hiring and retaining talent, and accordingly a risk to their businesses.<sup>237</sup> Strategic hiring of foreign-born staff must be balanced with employer-driven, public-private investments in training U.S. workers.

<sup>237</sup> Intel Corporation, “Form 10-K.” Micron Technology Inc, “Form 10-K.”

### **Opportunity: Enhance International Engagement and Cooperation on Range of Semiconductor-Related Issues**

The fact that most advanced technology links in the semiconductor supply chain are concentrated among countries that are U.S. allies and partners creates an opportunity to forge a cooperative, multilateral approach to semiconductor-related issues. These countries share many of the same concerns, including supply chain vulnerabilities, the importance of technological leadership, and countering China's aspirations. Ongoing engagement with these like-minded countries will foster harmonization of export control policies, international research partnerships, and amelioration of supply chain vulnerabilities by establishing a diverse supplier base. International engagement on these issues is necessary to promote a "level playing field" for U.S. industry. While industrial supply chains and investment are almost exclusively the purview of the private sector in the United States, the same is not true for Japan, South Korea, and Taiwan who have a long history of industrial coordination between the government and the private sector. As such, direct U.S. government involvement in coordinating efforts to build industrial partnerships between U.S. business and industrial partners in Japan, Taiwan, and South Korea is critical.

### **Opportunity: Encourage Private Sector Development and Implementation of "Best Practices" for Mitigating Semiconductor Supply Chain Risks**

Increasing awareness by private sector firms in both the semiconductor industry and in end user sectors of the importance of a comprehensive supply chain review can help identify sole/single sources for key materials and diversify suppliers/plants/geographies.

Many profit-seeking companies base their supplier decisions with the goals of minimizing costs, reducing inventories, and increasing utilization. This approach, however, may not allow for the flexibility to absorb disruptions in their supply chain. Moreover, companies may not be fully aware of the vulnerability of their supply chains to potential global shocks caused by natural or political phenomena. Given the number of locations from which materials are sourced, geographies where manufacturing operations take place, and transportation routes, supply chain risk management can be complex.

A "Best Practices" supply chain approach could assist companies in identifying and prioritizing risks and then developing policies to monitor and manage them. Better transparency and understanding of global supply chains can also allow for an evaluation with regard to such factors as workers' rights and environmental responsibility.

### **Opportunity: Domestic Production of Emerging Technologies Can Drive Demand for Semiconductors in the United States**

As noted above, U.S. semiconductor companies at various segments of the supply chain, including EDA suppliers, SME providers, and chip-makers, are highly dependent on foreign sales, particularly to China. This is because chip production is concentrated in East Asia and China is a leading consumer of semiconductors. According to the SIA, China accounts for approximately 24 percent of global consumption of semiconductors and the United States accounts for approximately 25 percent, making the United States and China the top two global consumer of semiconductors.<sup>238</sup> While current demand in the United States and China is roughly equivalent, in the next five years, demand in China is forecasted to continue to increase and to outperform the rest of the world.<sup>239</sup> This would increase U.S. semiconductor manufacturers' dependence on sales to China, risking financial vulnerabilities in the short- and long-term as discussed above.

The DoD market for trusted microelectronics is miniscule compared to the commercial market. But the *need for security* in microelectronics goes well beyond the fraction of DoD purchases that require trusted components. With some combination of increased market awareness and the associated risk mitigation, the market for "trustworthy" microelectronics could expand several times. In other words, if critical

---

<sup>238</sup> Varas et al. "Strengthening The Global Semiconductor Supply Chain In An Uncertain Era."

<sup>239</sup> Varas et al. "Strengthening The Global Semiconductor Supply Chain In An Uncertain Era."



infrastructure, mass transportation, 5G networks, industrial IoT, connected vehicles, and medical devices developed greater security requirements, market and cost structure would change substantially.

As the United States pursues leadership in next generation technologies and invests in key infrastructure projects such as high-speed broadband infrastructure, electric vehicles, electric grid resilience, and power generation modernization demand for semiconductors that are the linchpin of these technologies will increase, and that demand can be met in part with domestic production. Cultivating domestic development, production, and demand for these leading edge industries will provide an “anchor” for leading edge semiconductor technology and production. This will be beneficial for the DoD and national security, as defense needs alone are small compared with commercial markets. As semiconductors become increasingly embedded in and essential to technologies throughout the economy, secure supply chains are of growing importance to U.S. economic and national security.

### **Opportunity: Meeting the Climate Challenge**

The semiconductor industry is essential to meeting the climate challenge facing the United States and the world as a whole. The electric grid of the future—using 100 percent clean energy—will be built on semiconductor technology. By investing in domestic semiconductor research, development and production, the United States will be in the position to be a leader in the race to meet zero-emission goals, as well as competitive supplier of the products, equipment and technologies that will be needed to meet these goals.

Similarly, semiconductors are the key to more computationally-intensive electric vehicles of the future. A robust semiconductor supply chain that will accelerate the ability for the United States to manufacture clean cars and put those cars on U.S. and global roads.

### **Opportunity: Leverage Pollution Prevention Programs to Increase the Sustainability of Semiconductor Manufacturing**

U.S. semiconductor manufacturers and their suppliers can build markets and increase resilience by increasing their participation in efforts that seek to reduce the environmental footprint of their industry. There are several efforts that help to reduce or offset emissions from the industry.

Semiconductor manufacturers can improve their fluorinated greenhouse gas (F-GHG) destruction efficiency and implement process improvements to reduce those emissions. Electronic Product Environmental Assessment Tool (EPEAT), a global ecolabel that helps purchasers identify and procure more sustainable electronics, incentivizes the use of semiconductors made in 300 mm fabs that have reduced their F-GHG emissions on a metric ton CO<sub>2</sub>e basis in EPEAT registered computer products. Semiconductor manufacturing uses, and can emit, a variety of F-GHGs. Some of these F-GHGs are highly potent greenhouse gases that, pound-for-pound, trap up to 23,000 times as much heat as carbon dioxide in the atmosphere, where they can remain for thousands of years. Under the EPEAT program, computers can receive additional points and higher levels of registration (Silver or Gold) for using semiconductors from fabs with reduced F-GHG emissions, reducing the amount of F-GHGs emitted during the manufacturing process by over 90 percent. The U.S. Government is one of the largest purchasers of information technology (IT) products in the world, and is required to procure EPEAT registered products, sending a strong demand signal to the IT sector to incentivize manufacture and sale of more sustainable electronic goods. Purchasers around the globe have followed the U.S. federal government example and are also seeking out EPEAT products as part of their sustainable procurement programs. The Environmental Protection Agency conservatively estimates that reducing FGHGs released to the atmosphere during semiconductor manufacturing could result in a reduction of around 10 million metric tons of CO<sub>2</sub>e globally and around 2 million metric tons of CO<sub>2</sub>e in the United States from the baseline.

The Green Power Partnership program reduces pollution and the corresponding negative health and environmental impacts associated with conventional electricity use. The three semiconductor industry companies that were identified on the Partnership's top 100 Partners list used a total of 6,581,859,722 kWh of

green energy in the 2020 reporting year; two semiconductor manufacturers are using green power for 100 percent of their electricity.

Pollution Prevention centers across the United States can be funded to expand their mission to include research and outreach on preventing pollution at semiconductor fabs or in the industry's supply chain. The planned update of the EPEAT criteria will provide an opportunity to further incentivize shifts to more sustainable manufacturing of semiconductors. Efforts from allied industries to reduce carbon emissions, of which the Ultra-Low Carbon Solar Alliance is one, should be looked at for translation to the semiconductor industry. This effort aims to reduce the embedded carbon in solar materials. Similar materials and processes are used in semiconductor manufacturing and there may be opportunities here for environmental gains. New sources of funding should be considered to research recycling and reuse of semiconductor industry waste streams for this and other industries.

As domestic semiconductor-related plants are constructed or expanded to address supply chain vulnerabilities and to ensure continued U.S. leadership in this critical technology, there is also the opportunity to build them as next-generation facilities, where the energy they consume is moving toward clean power from zero carbon sources such as wind and solar (Clean Energy Standard).

## RECOMMENDATIONS

A secure and resilient semiconductor supply chain will require a whole-of-country effort, bringing together the resources and ingenuity of the private sector, the government, universities and other non-profits, and workers. This report makes seven major sets of recommendations to expand and secure the U.S. semiconductor supply chain:

1. Promote investment, transparency and collaboration, in partnership with industry, to address the current shortage
2. Fully fund the CHIPS for America provisions to promote long-term U.S. leadership
3. Strengthen the domestic semiconductor manufacturing ecosystem
4. Support SMEs and disadvantaged firms along the supply chain to enhance innovation
5. Build a talent pipeline
6. Work with allies and partners to build resilience
7. Protect the U.S. technological advantage

### **1. Promote investment, transparency and collaboration, in partnership with industry, to address the current semiconductor shortage:**

The current semiconductor shortage is the result of multiple factors, including unexpected shifts in global demand related to the COVID-19 crisis and events that disrupted specific major semiconductor manufacturing centers, such as the early 2021 storms in Texas that caused a shutdown of several semiconductor manufacturing plants. U.S. and global production continue to adjust to address the shortage; however, the shortage continues to negatively impact U.S. workers and consumers and is a persistent headwind to the U.S. economic outlook. While the private sector must take the lead in addressing the shortage in the near term, U.S. government can assist in mitigating the current shortage by facilitating investment, transparency, and collaboration with industry and with partners and allies.

- **The Department of Commerce should redouble its partnership with industry to facilitate information flow between semiconductor producers and suppliers and end-users:** In April, the Department of Commerce launched an initiative to convene industry stakeholders along the supply chain to increase communication and transparency. Through these meetings, industry has recognized that government can play a useful and supportive role accelerating information flow and identifying data gaps and investment opportunities. The Department of Commerce should bolster this work, potentially leveraging the convening power of the Department of Commerce's Advisory Committee on Supply Chain Competitiveness, Department of Homeland Security's Cybersecurity

and Infrastructure Security Agenda's Sector Coordination Councils, or other efforts. The private sector should continue to play a leading role, including through identifying ways to incentivize information-sharing across companies in these supply chains.

- **The Administration should strengthen engagement with allies and partners to promote fair semiconductor chip allocations, increase production, and encourage increased investment:** To date, U.S. government agencies have undertaken broad and high-level diplomatic outreach to ensure fair chip allocation and to affirm that the semiconductor manufacturing capacity in ally and partner countries is maximized. The U.S. government should continue engaging with allies and partners to encourage increased production and a fair allocation of supplies to American firms, while discouraging hoarding and other activities that will likely prolong the current shortage. The Administration should also continue its commercial diplomacy to promote investments by foreign firms in the domestic semiconductor industry. Such efforts have recently yielded success, for example resulting in the announcement of a partnership between the U.S. and South Korea to increase the global supply of mature node chips for automobiles and support leading-edge manufacturing in both countries.
- **Over the medium term, the Administration should advance the adoption of effective supply chain management and security practices by companies:** Companies—both semiconductor manufacturers and suppliers as well as in end-user industry sectors—can reduce the risk that a natural disaster or event can create a chokepoint that slows down or stops the entire supply chain. In addition, as discussed in this report, due to the complex supply chains, semiconductors are at risk of malicious insertions and counterfeiting. Specific recommendations to address these risks are as follows:
  - Companies should (1) make reasonable efforts to conduct scenario planning for disrupted supply and diversify sources to include multiple or lower-risk regions; (2) consider evolving product designs to allow more flexibility in chip use; (3) have faster upgrade cycles in products to reduce long-tail risk of stranded products; (4) ensure backward compatibility of form and function so that newer chips can be substituted for older ones; and (5) enter into contracts that allow for options to adjust quantities based on unexpected changes in demand.
  - To reduce the impacts of transportation and logistics issues, prior to making orders, companies should create scenarios of risk-adjusted demand so that the different scenarios can be factored into decisions regarding quantities of orders. To further assist in these efforts, companies can utilize technology platforms that provide better visibility into available logistics capacity.
  - NIST should continue to work with industry partners to identify supply chain challenges and provide potential solutions, including through its collaboration with industry on Supply Chain Assurance, which will produce example implementations to demonstrate whether purchased computing devices are genuine and unaltered during manufacturing and distribution processes.

## **2. Advance Long-Term U.S. Leadership and Resilience by Fully Funding the CHIPS for America Provisions in the FY 2021 NDAA.**

The Biden-Harris Administration applauds Congress for recognizing the importance of a robust domestic semiconductor manufacturing and research and development capability by authorizing the bipartisan CHIPS for America provisions in the FY2021 NDAA. As an initial step, Congress should fund the CHIPS provisions with at least \$50 billion in funding. Production incentives should support U.S. leadership in

leading edge chip production, secure mature node supply chains for critical industries, and ensure the safety and security of products produced domestically and by allies and partners.

- **Manufacturing:** Consistent with the American Jobs Plan proposals, federal incentives to build or expand semiconductor facilities are necessary to counter the significant subsidies provided by foreign allies and competitors. The NDAA authorized the Department of Commerce to award financial assistance to private entities or public-private consortia to finance, construct, expand, or modernize facilities to support semiconductor fabrication, ATP, and advanced packaging. These incentives should support production across multiple nodes. Investment should support production of leading edge logic production necessary to maintain competitiveness in the semiconductor industry, along with production of mature node logic chips and analog and discrete chips essential to critical industries and defense needs, and production of memory chips, which require support in the face of increased Chinese investment in the memory industry.
- **Research and Development:** Congress should also fund essential investments in R&D. As authorized by the NDAA, these funds could support an NSTC, to advance the next phase of innovation, advanced packaging and integration, research into new materials, architectures, processes, devices, and applications, and most importantly, bridges the gap between R&D and commercialization. The funds could support NIST in establishing new programs to foster the development of Advanced Packaging and Test capabilities onshore. Appropriations for may also support new or expanded R&D programs at the DoD. For example, DoD funds can be used to continue or expand R&D in DARPA's Electronics Resurgence Initiative, including for laboratory to fabrication programs. These efforts should be closely aligned with the NSTC R&D programs and priorities.
- **Multilateral Fund:** The NDAA authorized a Multilateral Semiconductors Security Fund which, if funded, should support the development and adoption of secure semiconductors and secure semiconductors supply chains. This should include joint R&D programs with allies. The Fund, operated by the Department of State, would support diplomatic efforts with foreign partners to align policies on export controls, foreign direct investment screening, supply chain security, intellectual property protection, and transparency requirements on subsidies.

### 3. Strengthen the Domestic Semiconductor Manufacturing Ecosystem

As discussed in this report, an ecosystem for semiconductor manufacturing is critical for fostering a robust and sustainable commercial semiconductor industry. The U.S. government should undertake the following measures to advance this goal:

- **Invest in the infrastructure needed to support semiconductor manufacturing:** Congress should pass recommendations in President Biden's American Jobs Plan, which, in addition to the requests for semiconductor research and manufacturing and for critical supply chain efforts, will drive U.S. demand for semiconductors through investments in key semiconductor using industries— including power generation transmission, clean energy, broadband, and electric vehicles— and, in turn, help incentivize private sector investments. In addition, investments in clean energy and water sources should offset the cost of energy for new semiconductor fabrication facilities – both are key inputs in semiconductor manufacturing.
- **Support private sector investments across the semiconductor manufacturing supply chain.**
  - Congress should authorize and fund incentives to support key upstream— including semiconductor manufacturing equipment, materials, and gases— and downstream industries throughout the supply chain. With additional authorized funds, the Department of Commerce could provide financial support for such facilities, EXIM could potentially provide loans or loan guarantees for those facilities where there is a sufficient export nexus, and SBA loans and programs could support small domestic suppliers.

- SelectUSA services to foreign-located businesses of international and U.S. origins seeking to invest in the United States can be used to attract investment in semiconductor manufacturing supply chains. SelectUSA services include market research products like Research and Locations Report services, investment counselling, introductions to state-level Economic Development Organizations to assist with organizing land and associated infrastructure, educational and matchmaking events, and assistance navigating the federal regulatory system.
- **Provide focused support for domestic chip production related to national security needs:**
  - DoD should support a study that analyzes SEE test requirements to determine whether additional investments are needed for construction of new SEE test facilities.
  - With additional resources, DoD should increase investments to upgrade SEE testing capacity at existing facilities to meet demand and through purchasing block-buys of SEE testing.
  - DoD should invest in radiation hardened microelectronics data collection, storage, analytics services to support a coordinated, centralized DoD SEE test resource management activities.

#### 4. Support Small and Medium-Size Semiconductor Businesses, including Disadvantaged Businesses

Small and medium sized suppliers represent the majority of U.S. firms involved in semiconductor and related device manufacturing and would benefit from specialized support to increase their market share and resilience. Their needs are diverse, ranging from R&D funding to prove emerging technologies, financing to support commercialization, and support in resisting predatory foreign acquisition practices. The Administration should help small businesses scale and connect to commercial production— including through existing SBA programs— by targeting promising areas of the semiconductor supply chain, such as design, semiconductor manufacturing equipment, materials, production services, fabrication, materials, ‘assembly, test and packaging’ and advanced packaging. Further, the Administration should help commercialize new technology by targeting investments to promising late-stage innovators.

- **R&D funding:** The Small Business Innovation Research/Small Business Technology Transfer (SBIR/STTR) program should be used in a consistent and coordinated manner by large Federal R&D agencies (Departments of Defense, Commerce, Energy) to signal commitment and interest in U.S. innovation and emerging technologies, especially for startups and small businesses in fields related to the semiconductor industry. This can be used to establish a wide community of practice that intentionally incorporates innovative small businesses, and expands connections with Accelerators at universities, including at historically black college and universities (HBCUs) and minority-serving institutions (MSIs), to pull technology forward.
- **Support for commercialization:** Promising small businesses should be supported by Federal agencies to scale their businesses, connecting these firms to the commercial value chain via a clearly mapped “growth chain.”
- **Address capital needs for growth:** SBA should assist U.S. small semiconductor firms by drawing the attention of private investors in the Small Business Investment Companies program as a potential source of debt and equity investment; and assisting these firms in making use of low-cost loan programs to obtain working capital, build inventory, drive domestic demand, buy out foreign owners and investors, finance equipment purchases and expand facilities.
- **EXIM can also assist with capital needs:** EXIM could provide loans or loan guarantees for capital investment for those facilities where there is a sufficient export nexus and provide loans and loan guarantees for exported U.S. goods and services.

## 5. Build a Diverse and Accessible Talent Pipeline for Jobs in the Semiconductor Industry

The Administration and Congress should make significant investments to grow and diversify the STEM talent pipeline, which is essential for semiconductor manufacturing and many other industries in the United States. It should also expand sectoral partnerships through which employers work in partnership with training providers, intermediaries, labor unions and community-based organizations to create pathways to job opportunities. Training should be paired with strong labor standards, including the free and fair choice to join a union and bargain collectively.

- **The Department of Labor's (DoL) Employment and Training Administration (ETA) should support sector-based pathways to jobs in the semiconductor industry.** To that end, ETA should continue to provide training grants and tools to partnerships that prepare workers for high-skill employment, including:
  - ETA should provide H-1B Skills Training Grants, which support training partnerships in key fields, which can include semiconductor manufacturing. These grants should target veterans, military spouses, transitioning service members, and underrepresented populations in the applicable sectors, including women, people of color, justice-involved individuals, individuals with disabilities, and other populations with employment barriers that hinder movement into middle- to high-skilled H-1B occupations.
  - The Administration should use ETA funds to work with industry and labor, community colleges, and non-profit partners to support pathways to semiconductor employment through its Registered Apprenticeship programs. Through industry and labor-driven partnerships, apprenticeships provide high-quality career pathways.
  - ETA should continue to promote and provide technical assistance on the use of semiconductor industry-related competency models, such as the Advanced Manufacturing Competency Model developed in collaboration with SEMI and other subject-matter experts. In consultation with ETA, SEMI is currently developing an additional level of detail for the Advanced Manufacturing Competency Model, describing the industry-sector technical competencies specific to the semiconductor sector. In the coming months, ETA plans to publish the updated model on its Competency Model Clearinghouse website.
  - The American Jobs Plan creates The Sectoral Employment through Career Training for Occupational Readiness program. Congress should fund these investments, which will be targeted to high-growth industries and sectors such as semiconductor manufacturing. Investments will support the formation of sector partnerships, development and scaling of sector training programs, and establishment of sector-focused career centers. The program will also provide supports to modernize the delivery of training, including using on-line modalities. The Department of Labor will make grants to consortia of workforce system entities, education providers, employers/industry groups, labor-management partnerships, community-based organizations, and unions. Investments can also be used to provide wraparound services and supports to help workers successfully complete the training programs. While this program will primarily target workers early in their career trajectory, it can be used to bring more underrepresented communities into this skilled workforce and begin building the pipeline
  - DoD should invest in a strategic Public-Private-Academic partnership workforce development model with a focus on 1) tailored curriculum to meet defense microelectronics talent needs; and 2) recruitment into the defense industry base and U.S. agencies.
- **Retain and support foreign workers filling essential gaps in the semiconductor workforce:** Losing top STEM talent to competitor nations is detrimental to U.S. competitiveness and especially counterproductive when the workers were educated at U.S. universities. Concurrent with funding semiconductor production incentives, Congress should address the immediate need for high-skilled semiconductor workers, including engineers and computer scientists, by increasing the number of

high-skilled visas, eliminating limits on employment-based visas by country and exempting highly-skilled STEM talent from employment-based visa caps. Congress should pass the U.S. Citizenship Act proposed by President Biden on January 20, 2021. Relevant measures of the bill:

- Increases the total number of available of employment-based visas and exempts spouses and minor children visa-holders from green card caps. By increasing the number of visas issued annually, and recapturing unused visas, the bill will clear the employment-based visa backlog and reduce wait times that can stretch decades.
  - Eliminates per-country visa caps to ultimately increase opportunities for high-skilled persons from larger nations like China and India.
- **Build a diverse pipeline of engineers and computer scientists, which require years of STEM education:**
    - Congress should invest in evidence-based CTE programs in middle and high schools to ensure that students are prepared to be successful in a variety of fields, including in advanced STEM fields. Funds should increase access to computer science and create high quality career pathway programs in middle and high schools, prioritizing models that allow students to earn college credit or result in a credential, and that connect underrepresented students to STEM and in-demand sectors, including programs that leverage partnerships between schools, community colleges and employers.
    - Congress should increase investments in the institutions with a track record of closing racial inequities in STEM fields. HBCUs and Tribal Colleges and Universities (TCUs), and MSIs such as Hispanic-serving institutions and Asian American and Native American Pacific Islander-serving institutions collectively enroll more than 6 million undergraduate students, of which 4 million are students of color. Appropriations should: include research and development grants specifically for HBCUs, TCUs, and MSIs; ensure students at HBCUs, TCUs, and MSIs have state of the art equipment, including upgraded brick-and-mortar laboratories and computing capabilities and networks; create 200 centers of excellence that serve as research incubators at HBCUs, TCUs, and MSIs to provide graduate fellowships and other opportunities.

## **6. Engage with Allies and Partners on Semiconductor Supply Chain Resilience**

Deepen engagement with allies and partners in support of a more resilient global semiconductor supply chain and shared benefits of additional research and development, beginning with the countries that are most integral to global semiconductor manufacturing. Specific recommendations are as follows:

- The Department of Commerce should encourage allied and partner foundries and materials suppliers to invest in the United States and allied and partner regions to provide a diverse supplier base.
- The interagency should promote research and development partnerships and harmonization of policies to address unfair trade practices and industrial policies.
- The interagency should continue to collaborate with allies and partners on supply chain concerns. This includes through the Quadrilateral Security Dialogue (United States, India, Australia, and Japan), which recently announced a dialogue on semiconductor supply chains, and through bilateral engagement with the Republic of Korea to facilitate mutual and complementary investment in semiconductors.

## 7. **Protect U.S. Technological Advantage in Semiconductor Manufacturing and Advanced Packaging Supply Chain**

- **Ensure that Export Controls Support Semiconductor Manufacturing and Advanced Packaging Supply Chain:** Export controls protect U.S. national security through identification of technologies that can enhance military, intelligence and security capabilities; and contribute to U.S. and allied and partner country technology leadership. Specific recommendations are as follows:
  - The Administration should target and implement export controls that can support policy actions to identify and address vulnerabilities in the semiconductor manufacturing and advanced packaging supply chain.
  - The Administration should target and implement export controls on critical semiconductor equipment and technologies to address certain supply chain vulnerabilities. The Administration should also make efforts to collaborate and coordinate with key supplier allies and partners on effective multilateral controls. Together, such controls will protect U.S. national security interests by limiting advanced semiconductor capabilities in countries of concern while enabling continued leadership of the U.S. semiconductor sector.
- **Continue to Ensure Foreign Investment Reviews for National Security Considerations in the Semiconductor Manufacturing and Advanced Packaging Supply Chain:** Similar to export controls, reviews of semiconductor industry-related foreign investment transactions by CFIUS include analysis of the threat, vulnerability and potential national security consequences of a specific transaction. CFIUS risk-based analysis can include factors relevant to supply chain resilience, such as the role of the target U.S. business in supply chains with national security implications. Specific recommendations are as follows:
  - In conducting its reviews, CFIUS should continue to consider the impact of the transaction on the national security vulnerabilities in the semiconductor manufacturing and advanced packaging supply chain identified in this report.
  - As authorized by the Defense Production Act, as amended, and subject to applicable confidentiality requirements, CFIUS should continue to conduct robust outreach as appropriate with foreign partners to share information regarding industry and acquisition trends and threats as well as to encourage allies and partners to implement robust national security-based investment screening regimes. These interagency efforts will continue to implement the strategy to build their capacity to review, mitigate, prohibit, or require divestment of foreign investments that may threaten national security interests, and to share information that will allow the United States and our partners to better identify and address transnational risks.



## ABBREVIATIONS

ASICS - Application-Specific Integrated Circuits  
AI - Artificial Intelligence  
ATP - Assembly, test, and packaging  
CTE - Career and Technical Education  
CSET - Center for Security and Emerging Technology  
CPU - Central Processing Unit  
CHIPS - Creating Helpful Incentives for Production of Semiconductors  
CFIUS - Committee on Foreign Investment in the United States  
CAGR - Compound Annual Growth Rate  
DUV - Deep Ultra Violet lithography  
DOL - Department of Labor  
DARPA - Defense Advanced Research Projects Agency  
DOD - Department of Defense  
DMEA - Defense Microelectronics Activity  
DRAM - Dynamic Random Access Memory  
EDA - Electronic Design Automation  
EPEAT - Electronic Product Environmental Assessment Tool  
ETA - Employment and Training Administration  
EU - European Union  
E.O. - Executive Order  
EXIM - Export-Import Bank of the United States  
EUV - Extreme Ultraviolet lithography  
FPGA - Field Programmable Gate Arrays  
FY - Fiscal Year  
F-GHG - Fluorinated Greenhouse Gas  
GaAs - Gallium Arsenide  
GaN - Gallium Nitride  
GPU - Graphics Processing Units  
HBCUs - Historically Black Colleges and Universities  
IT - Information Technology  
ISA - Instruction Set Architecture  
IDM - Integrated Device Manufacturer  
IP - Intellectual Property  
IoT - Internet of Things  
LiDAR - Light Detection and Ranging  
MEP - Manufacturing Extension Program  
MOCVD - Metal Organic Chemical Vapor Deposition  
MEMS - Microelectromechanical Systems  
MSIs - Minority-Serving Institutions  
nm - Nanometer  
NDAA - National Defense Authorization Act  
NIST - National Institute of Standards and Technology  
IC - National Integrated Circuit Fund (China)  
NSTC - National Semiconductor Technology Center  
NAICS - North American Industry Classification System  
NOI - Notice of Inquiry  
OECD - Organization for Economic Cooperation and Development  
OSAT - Outsourced Semiconductor Assembly and Test  
R&D - Research & Development  
STEM - Science, Technology, Engineering, and Math  
SIA - Semiconductor Industry Association  
SME - Semiconductor Manufacturing Equipment  
SMIC - Semiconductor Manufacturing International Corporation  
SRC - Semiconductor Research Corporation

SiC - Silicon Carbide  
SEE - Single Event Effect  
SBA - Small Business Administration  
SBIR - Small Business Innovation Research  
STTR - Small Business Technology Transfer  
SOEs - State-owned Enterprises  
TSMC - Taiwan Semiconductor Manufacturing Company  
TEL - Tokyo Electron  
TCUs - Tribal Colleges and Universities  
USB - Universal Serial Bus  
USPAE - U.S. Partnership for Assured Electronics  
WTO - World Trade Organization  
YMTC - Yangtze Memory Technology Company





**REVIEW OF LARGE CAPACITY BATTERIES**  
**DEPARTMENT OF ENERGY**

## EXECUTIVE SUMMARY

High-capacity batteries – used in electric vehicles (EVs), for stationary storage, and for many defense applications – offer an important and growing market that can support the creation of American jobs, help meet our national security needs, and bring ambitious climate targets within reach. The rationale for supporting the U.S. supply chain now is clear: demand for EVs and energy storage is increasing, investors are increasing investment in the clean economy, and the pandemic has underscored the fragility of some U.S. supply chains. China and the European Union (EU) – in contrast to the U.S. approach – have developed and deployed ambitious government-led industrial policies that are supporting their success across the battery supply chain. China has also moved beyond conventional policy support with practices involving questionable environmental policies, price distortion through state-run enterprises to minimize competition, and large subsidies throughout the battery supply chain. However, the opportunity for the United States to secure a leading position in the global battery market is still within reach if the Federal Government takes swift and coordinated action. This document identifies key opportunities and makes recommendations to seize those opportunities.

Government policies are needed to incentivize every stage of the U.S. battery supply chain including boosting demand for products like EVs and stationary storage that use high-capacity batteries. Strong demand for end products can unlock benefits from co-location (e.g., cost and flexibility benefits from placing battery pack and cell manufacturing near EV demand) and provide a foundation from which to compete in global markets.

The high-capacity battery supply chain consists of five main value chain steps including: 1) raw material production, 2) material refinement and processing, 3) battery material manufacturing and cell fabrication, 4) battery pack and end use product manufacturing, and 5) battery end-of-life and recycling. Coordinated government and private sector action is required across all five stages, as gaps can undermine efforts to secure the supply chain. For example, if the United States increases battery recycling rates and not processing capacity, recycled minerals will be exported for processing only to be re-imported at a later supply chain step.

This report highlights critical materials for high-capacity lithium-ion batteries – particularly Class I nickel, lithium, and cobalt – as primary upstream supply chain vulnerabilities. For raw material production, the first supply chain step, where demand can't be met through alternative means and secondary sources (e.g., increasing recycling, potentially sourcing from mine waste, identify mineral substitutes, etc.), the public and private sector should consider increased domestic production when strong labor standards and important environmental and cultural protections are applied to support economically viable domestic extraction. New responsible domestic extraction should focus on critical materials where the U.S. has known reserves significant enough to establish an economic base supply. For example, lithium could be a potential priority for increased domestic extraction given the United States holds 3.6 percent of the known global reserves, which could satisfy 2020 global lithium demand for more than 8 years. New raw mineral mining must be held to modern environmental standards, require best-practice labor conditions, and conduct rigorous community consultation, including with Tribal nations through government-to-government collaboration, while recognizing the economic costs of waste treatment and processing. The Federal Government in collaboration with the private sector must also continue a strategy of ally and partner engagement to diversify international sources and promote international environmental and labor standards.

For the second supply chain step of refining and processing, the United States has an even more significant deficit than in raw production capacity as critical minerals mined in the United States are often exported for processing. Increasing U.S. processing capacity alone would bolster the supply chain, and coupled with recycling, is the most promising pathway to securing the supply chain for minerals where the United States does not have significant reserves from which to extract. For example, China's strong supply chain position stems, in large part, from state investment in processing and manufacturing rather than an inherent advantage in reserves for most materials.

The third step focuses on manufacturing battery materials and cell fabrication and the fourth focuses on pack fabrication. For battery material manufacturing and cell fabrication, the United States has less than 10 percent of global market share for capacity across all major battery components and cell fabrication. Comparatively, China has over 75 percent of global cell fabrication capacity – largely driven by state investment in raw material processing, component and cell manufacturing, and EV deployment support, among other state interventions. For battery pack manufacturing, the United States has built up a manufacturing footprint largely to service North American EV production demand; however, the United States still lags behind other markets as domestic demand comprised only 12 percent of global EV demand in 2020 compared to roughly 40 percent in China and 40 percent across Europe. Federal funding for cell and pack manufacturing capacity can create the market conditions to catalyze greater private sector investment in this growing market.

Finally, the fifth supply chain stage of battery end-of-life is closely tied to the early stages of the supply chain. This stage can offset the need for new mining by increasing recycling and recovery of critical materials from products at the end of their life, offering another domestic source of critical materials. Coordinated U.S. investment and policy support to stimulate end product demand and build out the full end-to-end supply chain will be critical to securing and advancing a competitive position for the United States in the global battery supply chain. The recommendations presented in this report will translate to well-paying American jobs and will strengthen the U.S. energy, automotive, and defense sectors. The recommendations include:

## **STIMULATE DEMAND FOR END PRODUCTS USING DOMESTICALLY MANUFACTURED HIGH-CAPACITY BATTERIES**

### **Support Demand for Batteries in the Transportation Sector:**

- Electrify the Federal vehicle fleet and state, local, and Tribal government fleets
- Electrify the U.S. school bus and transit bus fleets
- Support “Point-of-Sale” rebates for consumers and a tax credit for medium and heavy-duty vehicles, with a preference for U.S. content
- Support the build out of EV charging infrastructure
- Support strong energy efficiency and tailpipe emissions standards for all vehicles

### **Support Demand for Batteries for the Utilities Sector:**

- Accelerate Federal battery storage procurement
- Expand the Internal Revenue Service (IRS) Investment Tax Credit (ITC) to include stationary storage as a stand-alone resource
- Institute power transmission regulatory reform to support renewable power and stationary energy storage

## **STRENGTHEN RESPONSIBLY-SOURCED SUPPLIES FOR KEY ADVANCED BATTERY MINERALS**

### **Invest in targeted, mineral-specific strategies:**

- Support sustainable domestic extraction and refining of lithium
- Support nickel and cobalt recovery from recycled and unconventional sources
- Invest in nickel refining in coordination with allies
- Identify opportunities for supporting sustainable production and refining of cobalt
- Work with allies and partners to expand global production and ensure access to supplies

**Raise labor and environmental standards across the board:**

- Develop strong environmental review permitting practices for the extraction of lithium, nickel, cobalt, and other key high-capacity battery minerals
- Leverage Federal investment to incentivize sustainable practices

**Increase resilience by strengthening U.S. recycling:**

- Establish a national recovery and recycling policy to propose targeted incentives for recycling, stand up a battery recovery and recycling task force, and ensure recycling and processing meet the highest environmental standards

**PROMOTE SUSTAINABLE DOMESTIC BATTERY MATERIALS, CELL, AND PACK PRODUCTION**

**Catalyze Private Capital with Grants and Loans:**

- Enact new Federal grant programs to catalyze private capital
- Leverage the Department of Energy's (DOE's) Advanced Technology Vehicle Management Loan Program

**Introduce Supportive Tax Credits:**

- Revitalize IRS 48C manufacturing tax credits
- Revive and expand Section 1603 of the American Recovery and Reinvestment Tax Act (ARRTA) program to support small manufacturers in the batteries, cells, and related material processing supply chain

**Leverage Federal Procurement and Financial Assistance:**

- Strengthen U.S. manufacturing commitments in Federally-funded grants, cooperative agreements, and research and development (R&D) contracts

**INVEST IN THE PEOPLE AND INNOVATIONS THAT ARE CENTRAL TO MAINTAINING A COMPETITIVE EDGE**

- Invest in the Next Generation of Battery and EV Industry Workers:
- Develop the workforce needed for the growing battery manufacturing industry
- Include labor standards as a condition on production subsidies to empower workers and support their free and fair choice to organize

**Increase Funding for R&D to Expand Uptake and Reduce Supply Chain Vulnerabilities:**

- Increase support for R&D to reduce battery cell costs, enhance performance, and reduce dependency on key critical materials
- Create a Manufacturing USA Institute for high-capacity batteries



## INTRODUCTION

The high-capacity battery market is arguably one of the most critical to our Nation's interests. The cost per kilowatt-hour (kWh) of lithium-ion batteries has declined more than 80 percent over the last decade, and this cost decrease has made these batteries very attractive to new and growing markets including the electric vehicle (EV) and stationary storage markets. The cost reduction has been, and continues to be, driven by advances in material technology, cell manufacturing, and economies of scale. Demand from the EV and stationary storage markets is projected to increase the size of the lithium battery market by another factor of five to ten by 2030. As a result, industry and numerous governments throughout the world have identified lithium-ion and more advanced lithium-based batteries as critical enabling technology for success in the next generation clean energy marketplace and for achieving vital economic, energy, national security, and climate priorities.

Many governments and government coalitions have adopted coordinated, government-led strategies and industrial policies to advance their high-capacity battery supply chain that significantly disadvantage markets that do not take a coordinated approach. In the European Union (EU), policies enacted to meet climate change goals, including the EV sales mandates and the Battery Directive on Recycling, should create additional pressure on industry to accelerate the timeline for EV adoption. In contrast, China has positioned itself as a market leader in the manufacturing supply chain through the practice of questionable environmental policies, price distortion, state-run entities that minimize competition, and large subsidies throughout the battery supply chain.

Therefore, it is critical for the United States to leverage our leading position in research and development (R&D) of new technologies with a comprehensive set of domestic and international initiatives to accelerate commercialization throughout the battery supply chain. This strategy would translate to well-paying jobs throughout the United States and represents a once-in-a-generation opportunity to position the United States as a global leader in the manufacturing of energy storage materials and technologies to protect both the environment and our economic and national security interests.

For this report, "high-capacity" cells are defined as having a gravimetric energy density of 200 watt-hour per kilogram (Wh/kg) or greater. For reference, the Tesla Model 3 uses cells that deliver 240 Wh/kg, and many other commercially available EV battery cells approach that capacity, so 200 Wh/kg and above is well inclusive of the range of current technology. Lithium-ion and rechargeable lithium metal anode batteries, hereafter referred to as "lithium batteries," comprise the overwhelming majority of both the present and future of this high-capacity battery market. Sodium-ion and other battery technologies could play a role in future stationary/grid markets, and possibly for automotive applications. However, their uncertain advantage over lithium-ion in performance and cost, the dominance of lithium-ion in current deployments, the multibillion-dollar capital cost investment requirement to establish a position in this market, and the relative immaturity of competing technologies argues in favor of the incumbent lithium-ion technology remaining the dominant force for the near and intermediate term.

### **Downstream Market Overview: Electric Vehicles**

With the increasing electrification of the U.S. transportation sector, employment is already growing in the EV market, with electric hybrids, plug-in hybrids, and all EVs supporting 198,000 U.S. employees in 2016,<sup>1</sup> and 242,700 U.S. employees in 2019.<sup>2</sup>

---

<sup>1</sup> U.S. Department of Energy, "2017 US Energy and Employment Report (USEER)," January 2017. Accessed November 9, 2019.

<sup>2</sup> U.S. Department of Energy, "2019 US Energy and Employment Report (USEER)," January 2019. Accessed March 31, 2021.

The automotive industry will likely drive the demand for batteries. Bloomberg projects worldwide sales of 56 million passenger EVs in 2040, of which 17 percent (about 9.6 million EVs) will be in the U.S. market.<sup>3</sup> If all batteries for Bloomberg's projected 9.6 million U.S. passenger EVs were manufactured abroad, that would result in roughly \$100 billion in imports.<sup>4</sup> Hence, capturing this market is imperative for the future viability of the U.S. auto industry, which historically has contributed 5.5 percent of the total annual U.S. gross domestic product (GDP).<sup>5</sup>

As seen in Figure 1, global lithium-ion battery demand in all market segments is projected to grow in the coming years, with passenger EVs dominating the market. The value of the EV battery market, assuming \$100/kWh EV batteries, is expected to be over \$50 billion in 2025. EVs are a critical driver of the demand for high-capacity batteries and are the primary market focus when assessing the need for domestic battery manufacturing. Roughly 3.1 million EVs were sold globally in 2020 representing over 40 percent growth over 2019 volumes, while overall vehicle sales contracted 15 percent for the year due to COVID-19.<sup>6</sup> EV sales are concentrated in markets with significant government initiatives (e.g., mandates and incentives) for production and purchase of EVs such as Europe and China, which each had roughly 40 percent of 2020 global EV sales. The U.S. market had roughly 12 percent of global EV sales in 2020, as shown in Figure 2 (showing EV sales in the five countries with the top sales). China led sales in the last five years and had over 50 percent of global sales in 2017 and 2018. Policy drivers are closely linked to sales patterns because EV batteries remain relatively expensive, making EV powertrains difficult for manufacturers to sell outside of incentivized markets today. Batteries are estimated to comprise 50 percent of the vehicle cost for some earlier EV models; however, EV batteries, specifically lithium batteries, have been declining in cost.<sup>7</sup> Due to steadily falling prices, industry analysts predict that by 2030 global cell production will be around 2,000 GWh with the vast majority aimed at vehicle sales<sup>8</sup>

---

<sup>3</sup> BloombergNEF, Electric Vehicle Outlook 2019. May 2019. <https://about.bnef.com/electric-vehicle-outlook/>. Accessed March 15, 2021.

<sup>4</sup> Assumes each EV will have a 100 kWh battery pack produced at \$100/kWh, making the cost \$10,000 per battery pack. The \$100B market is based on \$10,000 per pack and approximately 10M EVs sold in 2040.

<sup>5</sup> Alliance for Automotive Innovation, "Driving the U.S. Economy," 2020. <https://www.autosinnovate.org/initiatives/the-industry>. Accessed April 27, 2021.

<sup>6</sup> IEA – International Energy Agency. "How global electric car sales defied Covid-19 in 2020". January 28, 2021. <https://www.iea.org/commentaries/how-global-electric-car-sales-defied-covid-19-in-2020>. Accessed May 2, 2021.

<sup>7</sup> BloombergNEF estimates the 2010 price of lithium-ion cells was roughly \$1,100/kWh. This puts the estimated price of the cells alone in the original 16kWh Chevrolet Volt battery pack at around \$17,600. That amount was nearly half the Volt's suggested retail price at the time.

BloombergNEF, "Battery Pack Prices Fall as Market Ramps Up With Market Average At \$156/kWh In 2019". December 3, 2019. <https://about.bnef.com/blog/battery-pack-prices-fall-as-market-ramps-up-with-market-average-at-156-kwh-in-2019/?sf113554299=1>. Accessed March 30, 2021.

<sup>8</sup> BloombergNEF, Electric Vehicle Outlook 2020. <https://about.bnef.com/electric-vehicle-outlook/>. Accessed April 27, 2021.

Figure 1. Worldwide anticipated use applications of lithium-ion batteries.<sup>9</sup>

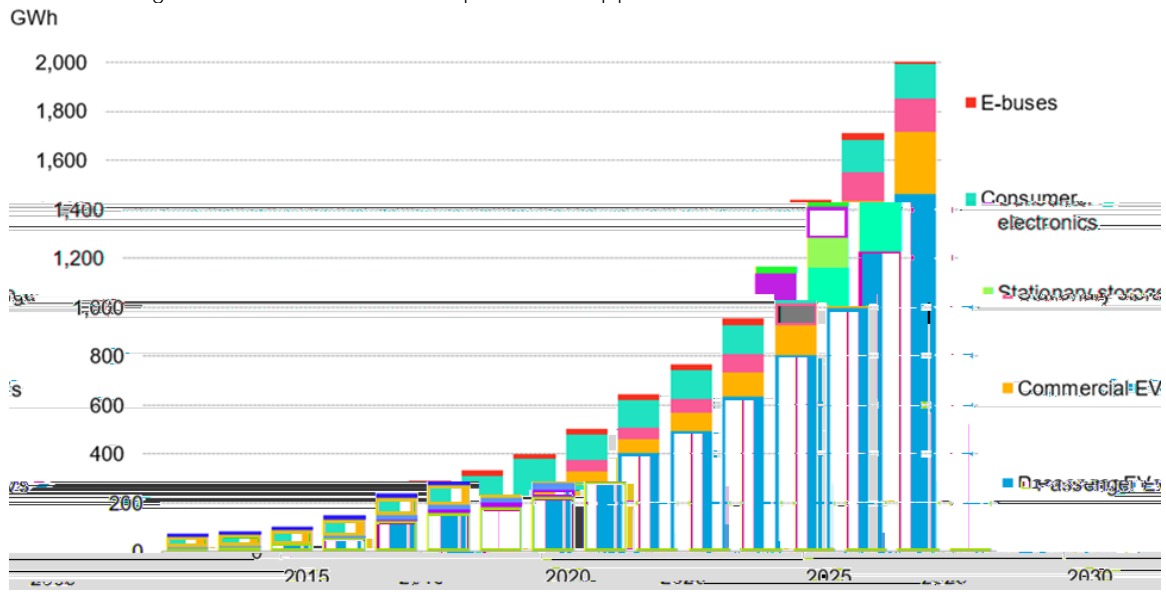
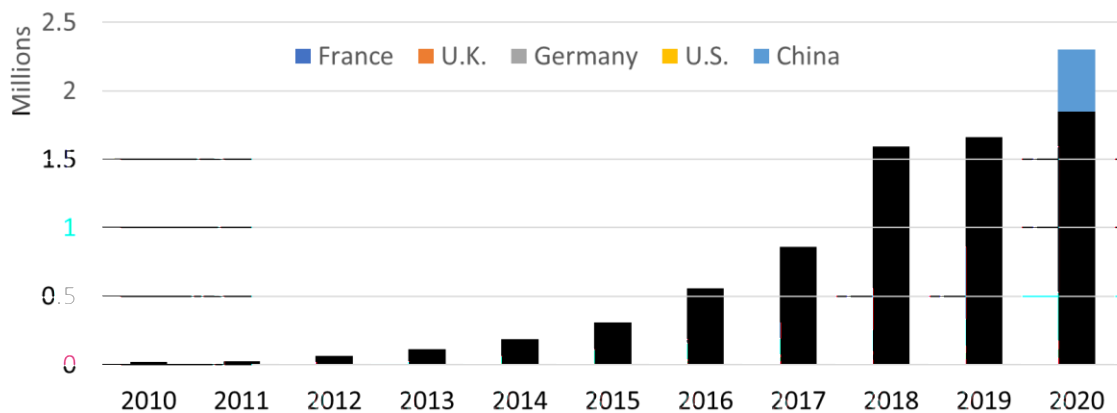

Figure 2. EV Sales by year in top five countries.<sup>10</sup>



### Downstream Market Overview: Stationary Storage

The market for stationary storage is also projected to increase substantially in the next 10-20 years, in particular, in the power system. As costs for variable electricity generation like wind and solar lead to increasing deployment of these power sources on the grid, the demand for technologies that can both absorb excess low-cost generation and contribute to supply during times of peak demand will increase as well. While vehicles are likely to be the primary driver for lithium batteries, stationary applications create additional market applications for high-capacity lithium batteries, in particular those requiring four hours of continuous discharge or less.

Battery stationary storage systems, or non-motive battery systems connected to the electric grid or distributed to support a commercial, industrial, or at-home site, are growing at non-linear rates. In the third quarter of 2020, the United States added 578 megawatt-hours (MWh) of energy storage capacity, an increase of 240 percent over the previous high set in the previous quarter (second quarter of 2020).<sup>11</sup> Lithium-ion batteries

<sup>9</sup> BloombergNEF, Long-Term Electric Vehicle Outlook 2019. Available for purchase.

<https://about.bnef.com/electric-vehicle-outlook/>. Accessed March 5, 2021.

<sup>10</sup> BloombergNEF, Interactive Datasets: Electric Vehicles, “Electric Vehicle Sales by Country;” accessed: May 3, 2021.

<sup>11</sup> <https://energystorage.org/us-energy-storage-market-shatters-records-in-q3-2020/>

accounted for 99 percent of the added MWh. Global capacity estimates vary by source but installed stationary battery storage capacity is projected to grow from 8 gigawatt-hours (GWh) in 2018 to 155 GWh in 2030, a nearly twenty-fold increase.<sup>12</sup> Currently, Korea, Japan, and the United States are the three largest global markets for stationary battery storage, respectively. Over the next two years, the United States is projected to become the largest global market for stationary storage, and by 2050, China, the United States, and India are projected to be the three largest global markets.<sup>13</sup>

Global drivers for battery storage deployments for the electric grid vary by location, and policies such as mandates, regulatory reform and incentives are currently the main market drivers. However, as the levelized cost of electricity for battery storage systems continues to decrease, battery storage will increasingly displace other electric grid assets on a cost-competitive basis.<sup>14</sup> There are already discrete examples where battery energy storage is cost competitive, such as peaking plant replacement,<sup>15</sup> diesel generator replacement,<sup>17</sup> capacity and resource adequacy, and as an asset to provide ancillary services.<sup>18</sup>

With greater duration requirements and less stringent density and weight constraints, non-lithium storage technologies may emerge as the most cost-effective long-term solutions for stationary storage. Stationary energy storage can benefit the electricity grid by providing many services to facilitate the use of intermittent renewable energy sources, serving remote communities, supporting electrification of transport and other sectors, increasing resilience, optimizing energy production and usage, and servicing critical services like healthcare. Looking ahead through 2030, the materials for lithium battery stationary applications are expected to use largely the same materials as EV batteries, with modified cell design and battery voltage utilization changes to meet specific requirements.

## **Downstream Market Overview: Defense Applications**

Establishing and protecting a high-capacity battery manufacturing capability in the United States, as well as in allied and partner countries, is critical to U.S. national security and is essential to developing resilient defense supply chains that are not under threat from potential adversaries. While the supply chain security of minerals, materials, and cells is of concern today within the Department of Defense (DOD), the rising demand and diversity of applications for lithium battery technologies make the future strategic concerns even more important. To meet maritime, surface, undersea, space, air, and ground operational requirements, DOD will need reliable and secure advanced battery technologies.

Given the current and projected growth in the lithium battery market, and the critical strategic importance of storage technology, it is not surprising that so many organizations, from companies to countries and economic unions, have identified battery production and its associated supply chains as areas of great importance. China in particular has created a distorted supply chain landscape through non-market or government intervention from state-controlled firms, both domestically and in developing economies. This includes massive subsidies for raw material processing and cell production as well as an estimated \$100 billion plus in direct government subsidies for EVs in the last 10 years, according to one estimate. Given the similar

---

<sup>12</sup> Bloomberg New Energy Finance, 2019 Long-Term Energy Storage Outlook, July 31, 2019, page 60.

<sup>13</sup> Bloomberg New Energy Finance, Battery Storage Database, Accessed February 19, 2020.

<sup>14</sup> <https://www.nrel.gov/docs/fy19osti/73222.pdf>

<sup>15</sup> Institute for Energy Economics and Financial Analysis, “New York looking at battery storage to replace natural gas peaker plants”, July 9, 2019. <https://ieefa.org/new-york-looking-at-battery-storage-to-replace-natural-gas-peaker-plants/>. Accessed April 14, 2021.

<sup>16</sup> Renewable Energy World. “Minnesota Utilities Weigh Energy Storage as Substitutes for Peaker Plants”, July 16, 2019. <https://www.renewableenergyworld.com/2019/07/16/minnesota-utilities-weigh-energy-storage-as-substitute-for-peaker-plants/#gref>. Accessed April 14, 2021.

<sup>17</sup> Climate Action, “Tesla to Replace Backup Diesel Generators with 200 Battery Systems on the US Island of Nantucket”, November 10, 2017. <http://www.climateaction.org/news/tesla-to-replace-backup-diesel-generators-with-200-battery-systems-on-the-u/>. Accessed April 14, 2021.

<sup>18</sup> Energy Storage News, “German storage system proves batteries ‘profitable without subsidy’”, May 20, 2019. <https://www.energy-storage.news/news/german-storage-system-proves-batteries-profitable-without-subsidy>. Accessed April 14, 2021.

history of Chinese non-market intervention in the solar and rare earth industries, and China's stated intentions in the Made in China 2025 initiative, there is cause for concern that, without a proactive response from the United States, this growing field will face those same challenges. Government in concert with the international community.<sup>19</sup>

Industry actors along the supply chain have indicated that cell production will largely follow demand for EVs. The heavy weight of cells and the fact that they are classified as hazardous materials makes transportation expensive and creates co-benefits from locating these stages of the supply chain near end-product manufacturing. In addition, automotive production depends heavily on just-in-time delivery aimed at reducing inventory costs and enabling ongoing quality improvements. Content requirements under trade agreements, like the United-States-Mexico-Canada Agreement (USMCA), offer further incentives to localize battery production. The high regional content levels under USMCA mean companies must have qualified production of both cells and finished batteries to receive tariff preference. However, domestic end-product demand is necessary, but not sufficient absent coordinated policy across the full supply chain, to drive domestic production.

There are many emerging lithium battery technologies, such as lithium metal anodes, solid-state batteries, silicon anodes, and next generation cathodes that promise improved performance and could potentially alter the supply chain landscape. For years, U.S. institutions have been at the forefront of advanced cell research, often to see the technology purchased, scaled-up and commercially deployed overseas. U.S. leadership in R&D presents an opportunity to establish domestic production of future battery technologies, thus allowing the United States to leapfrog our competitors in the battery cost, performance, and manufacturing race. To help organize a coordinated response across different government stakeholders, the Department of Energy (DOE) helped establish the Federal Consortium for Advanced Batteries (FCAB), which is led by the DOE, DOD, Department of Commerce (Commerce), and Department of State (State), and includes many organizations across the Federal Government. This initiative, currently chaired by DOE, will work to develop a detailed framework including performance metrics, domestic supply, and other factors for screening emerging material supply chains for vulnerabilities and opportunities.

In the event of a supply chain disruption for any of the critical inputs that battery manufacturers rely on to make high-capacity batteries, the automotive industry, defense supply chain, and the power sector would experience the most direct impacts. All three sectors rely on batteries either within critical products (e.g., EVs) or as a final product itself (e.g., stationary storage).

## MAPPING OF THE SUPPLY CHAIN

To understand the vulnerabilities and opportunity space in the lithium battery market, the value chain segments for the lithium battery supply chain ecosystem must be defined (Figure 3). Creating a comprehensive, coordinated approach to secure each value chain segment will help minimize the risk of manipulation while maximizing the domestic economic impact of each battery deployed, regardless of the end application.

- **Raw materials production:** This stage covers the production of battery materials including from brine, clay, seawater, and rock deposits. Each deposit type has particular methods for extraction and separating materials, all with varying levels of economic viability based on the properties of the deposit, projection of product yield from the deposit, and specific content purity. Almost all production of raw materials for lithium ion batteries, apart from some lithium extraction and refinement, occurs abroad today.
- **Materials purification and refinement:** This stage, also referred to as "processing", covers the activities of taking the raw produced materials in their base form and refining them to the constituent that is used to make the products in the next stage. This step is especially important in battery technology because

---

<sup>19</sup> Center Strategic and International Studies, "The Coming NEV War? Implications of China's Advances in Electric Vehicles", Scott Kennedy, November 18, 2020. <https://www.csis.org/analysis/coming-nev-war-implications-chinas-advances-electric-vehicles>. Accessed April 27, 2021.

the material purity required in batteries is high, as impurities can drastically impact the life and safety of the end product.

The United States currently has virtually no domestic processing capacity, so the limited raw materials produced today are primarily shipped overseas for processing. China has exerted an outsized influence in this value chain segment to create a position of strength in the supply chain for minerals even where they have limited geologic deposits and natural advantages. For instance, China is the primary global supplier of cobalt for batteries, despite having very limited reserves, through its aggressive investment in processing capacity coupled with foreign direct investment for ores and concentrates.

- **Processed material and cell manufacturing:** This stage includes the steps of taking processed elements and combining them for integration into a battery cell. This includes cathode and anode powder production, electrolyte mixing, separator production, binder and conductive additive production, and electrode and cell manufacturing. This is the first step in the process where market pull begins to significantly favor co-location with the end-product.
- **Pack and end use product manufacturing:** Battery pack and end use product manufacturing focuses on taking the manufactured cell and assembling it in the final battery pack assembly with the necessary cell balancing and power electronics equipment. From there, it is integrated into the final manufacturing step where the finished battery pack is integrated into an end product (e.g., an EV). The United States is well positioned to build on stable pack manufacturing capacity within the growing battery market. For pack manufacturing, this area has historically been where precompetitive advantage is established between automotive original equipment manufacturers (OEMs) to integrate advanced cell technology with proprietary data, and typically attracts the most private internal industry investment.
- **End-of-life:** This stage deals with the ecosystem around recycling or disposing of batteries after the end of initial use. This area includes the potential second use markets for battery materials, as batteries that are no longer suited to one application may still have a useful life in another (e.g., EV batteries may have second life in stationary storage applications), as well as recycling into metals and materials that can be used again in the production of new batteries. Recycling of waste product from the manufacturing process (e.g., scrap) can also be used to capture materials and increase overall manufacturing efficiency. The economics of recycling are very dependent on material composition of the battery, collection, disassembly, storage, transportation, and processing costs. Transportation and disassembly costs together account for over half of the end-of-life costs overall, as will be laid out in later sections. Increased recycling can decrease the need for new raw material extraction and production. Different recycling processes reintroduce that material at different stages of the supply chain. A more robust domestic recycling industry will be most effective at securing material supply chains if paired with growth at various stages of manufacturing. Without a footprint in the earlier stages of manufacturing (including materials processing, as well as electrode, cell, and pack manufacturing), intermediate recycled products will be exported to markets/countries that have these capabilities.

Figure 3. Lithium-Based Battery Supply Chain

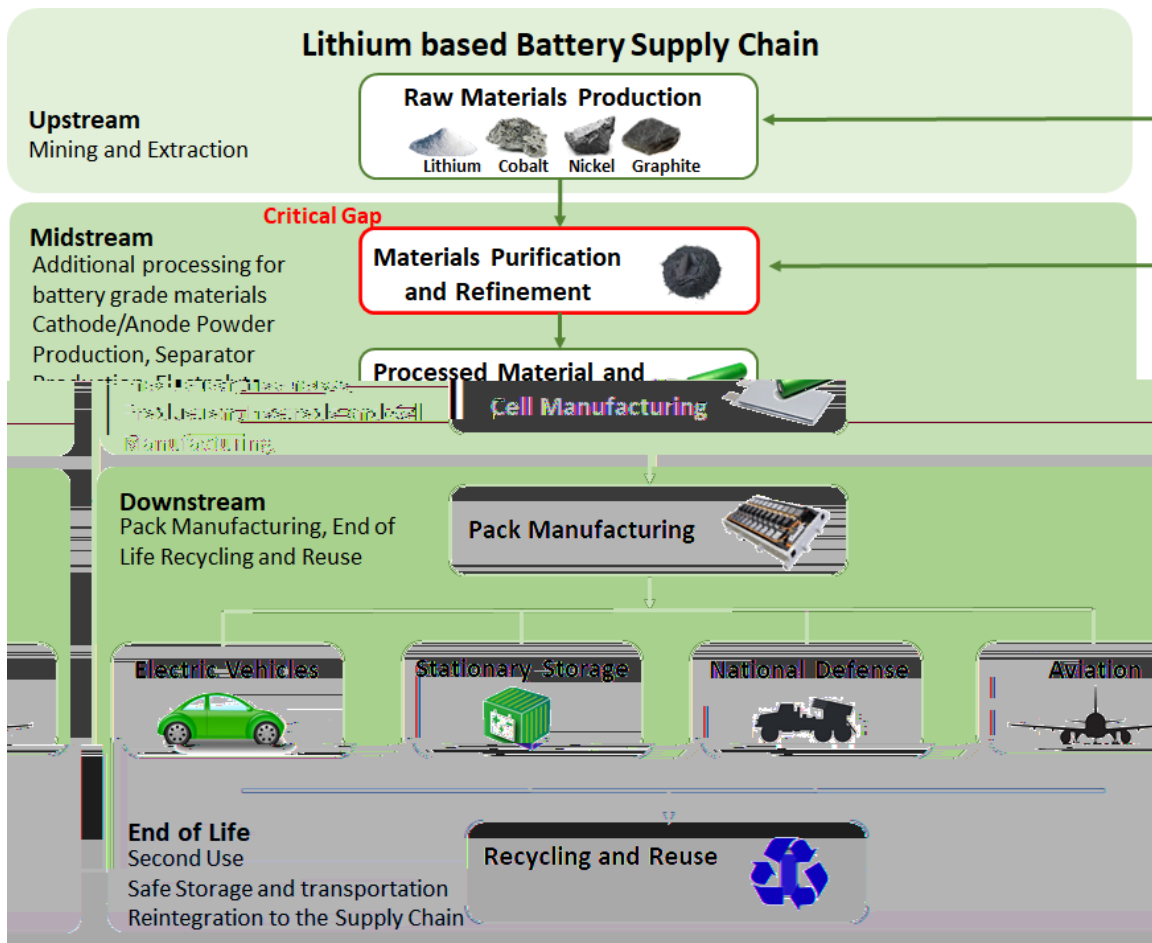

Source: DOE Vehicle Technologies Office (VTO)

Given the reliance of each value chain segment on the preceding step, securing the supply chain from exposure to hazards and subsequent supply risk, including market manipulation, requires an end-to-end coordinated supply chain strategy. Currently, the United States has limited raw material production capacity and virtually no processing capacity. Without processing capacity, the United States exports the limited raw materials produced today to foreign markets, thereby ceding not only the processing activity, but also any geographic advantage in the cell manufacturing activity utilizing the material. Manufactured cells must then be imported into the United States to support battery pack manufacturing, where the economics might otherwise support U.S. cell assembly facilities. This current approach to the U.S. supply chain exposes the downstream value chain to additional supply chain risk from the reliance on foreign inputs from the upstream value chain, especially the lack of domestic processing.

The upstream value chain for lithium batteries consists of multiple elements that perform vital functions for battery performance and constitute a majority of the material composition of a lithium battery. Each element has a unique raw material input, refining need, advanced materials synthesis processing, and finished powder or component that goes into the battery. The multitude of materials and evolving makeup of these batteries present a challenge for sustained revenue-positive recycling in particular, due to the extra cost from separation of the various materials and the need for more advanced processing techniques. For example, the most abundant material in lithium batteries accounts for less than 33 percent of all materials in the batteries, compared to the historical precedent for recycling where approximately 65 percent of a lead-acid battery came from lead.

The main elements used in current and emerging lithium batteries are:

- *Current collectors:* Aluminum, Copper
- *Cathode materials:* Lithium – and may include a combination of Nickel, Cobalt, Manganese, Iron, Phosphorous, Aluminum, or Sulfur
- *Anode:* Graphite (Carbon), Silicon, or Lithium (metallic foil)
- *Electrolyte:* Lithium, Phosphorous, Fluorine

Of these, lithium, Class 1 nickel, and cobalt are considered the most critical minerals used in the production of lithium batteries when applying the following methodology to assess the criticality of the materials:

- (1) *Importance:* The short-term market dependence on this element and how likely that dependence will stay the same or improve in the future.
- (2) *Substitutability:* How easily an element can be replaced quickly for integration into an established battery manufacturing line without significantly decreased performance.
- (3) *Potential for U.S. competitiveness:* Likelihood for the United States to achieve competitiveness in this area in the future based on the current market and relative maturity to the incumbent state of the art.

Graphite, manganese, and copper represent additional elements of note and require monitoring despite being considered less critical than the three elements emphasized above. These additional materials have supply chain challenges beyond the three criteria noted above.

The list of battery critical materials addressed in this document differs from the Federal List of Critical Minerals. The distinctions are driven by the authors' specific focus on the lithium-ion battery supply chain, which requires a higher consideration and weighting for future reliance and supply chain quality measures. There was extensive consultation with industry to arrive at these conclusions.

There are several distinctions between the methodology used to determine the battery critical materials for this report and that used by the Department of Interior (DOI) and interagency, of which DOE was a member,<sup>20</sup> to develop the Federal List of Critical Minerals.<sup>21</sup> The Federal list uses a supply-side methodology and generally evaluates mineral commodities in the upstream supply chain. One major difference is that this report evaluates a higher emphasis on the "quality" of the supply chain specific to elements used in batteries. The net result of the evaluation used in this report is the inclusion of class 1 nickel, and the de-emphasis of graphite and manganese as materials of greatest concern compared to other more generalized U.S. government assessments. The de-emphasis for graphite is largely based on the growing synthetic graphite production and price reduction domestically, as well as advancements in fundamental understanding of the applicability of substitutes. While manganese is not produced domestically, the wide geographic distribution and the U.S. relationships with those countries of origin make it less of a concern.

Cobalt received the lowest "quality" supply chain score of all elements, largely due to the alleged mining conditions in the Democratic Republic of the Congo (DRC) and conditions surrounding cobalt refining in China. In this approach, the country of origin for both raw materials and purification are considered, and if either step includes more than 50 percent import reliance on a country with questionable and/or strained relations with the United States, it is considered critical.

---

<sup>20</sup> USGS, "Draft Critical Mineral List—Summary of Methodology and Background Information—U.S. Geological Survey Technical Input Document in Response to Secretarial Order No. 3359", 2018. <https://pubs.usgs.gov/of/2018/1021/ofr20181021.pdf>. Accessed 14 April 2021.

<sup>21</sup> Federal Register, "Final List of Critical Minerals 2018", May 18, 2018. <https://www.federalregister.gov/documents/2018/05/18/2018-10667/final-list-of-critical-minerals-2018>. Accessed 14 April 2021.



## What does the supply chain look like?

Given the importance of lithium, Class 1 nickel, and cobalt in the production of lithium batteries, these elements represent the emphasis of this analysis. Analysis to quantify the potential of these materials for domestic extraction from both unconventional and secondary sources is currently ongoing; however, at present, very limited commercial operations to tap these sources exist in the United States. Research, development, and demonstration (RD&D) of innovative means of processing and recycling these elements from unconventional and secondary sources remains a top priority. In parallel with this RD&D work, additional focuses must center on addressing near-term needs and addressing the other RD&D challenges present in the supply chain for these elements to increase economic competitiveness.

There is a consensus among automotive manufacturers, battery suppliers, and governments that sales of EVs are poised to rapidly accelerate. As this acceleration occurs, lack of sufficient planning could expose the various global actors to potential material shortages.<sup>22</sup> Avoiding these shortages depends on the ability for the market to anticipate material demand and the capacity of the extraction, recycling, and purification markets to meet that demand. Considering the often 5+ year development of a source for extraction, forecasting future needs, planning for sufficient material production, and standing up operations in time to meet demand can pose a significant challenge. The large majority of EVs use a battery chemistry of graphite anodes and a high nickel version of nickel manganese cobalt oxide or nickel, manganese, cobalt and aluminum cathodes, of which Class 1 purity (99.8 percent and above) is required. Table 1 shows the amount of each element in the cathode that is needed to electrify 20 percent and 100 percent of the U.S. light duty vehicle (LDV) fleet; the table also shows domestic and global mineral reserve metrics from DOI's United States Geological Survey (USGS). This does not include the potential for recycling, which has the potential to be an additional source of domestic materials.

Table 1. The amounts of elements needed for EV batteries compared to the 2019 mined, global, and domestic reserves amounts of those elements.<sup>23</sup>

<b>Cathode element</b>	<b>Needed for 20% EV sales (tonne)</b>	<b>Needed for 100% EV sales (tonne)<sup>24</sup></b>	<b>Material mined in 2019 (tonne)</b>	<b>Global reserves (tonne)</b>	<b>U.S. Reserves (tonne)</b>
<b>Nickel<sup>25</sup></b>	254,530	1,272,650	1,000,000 <sup>26</sup> (Class 1)	89,000,000 (Class 1 & 2)	110,000 (Class 1 & 2)
<b>Lithium</b>	37,750	188,700	77,000	17,000,000	630,000
<b>Cobalt</b>	31,820	159,800	140,000	7,000,000	55,000
<b>Manganese</b>	29,660	148,300	18,500,000	810,000,000	NA

<sup>22</sup> IEA, The Role of Critical Minerals in Clean Energy Transitions, May 2021. <https://www.iea.org/reports/the-role-of-critical-minerals-in-clean-energy-transitions>. Accessed May 25, 2021.

<sup>23</sup> DOE Analysis using USGS data. USGS. 2019. "Material Commodity Summaries 2019", mcs2019\_all.pdf (prd-wret.s3-us-west-2.amazonaws.com). Accessed April 22, 2021.

<sup>24</sup> tonne = metric tons. DOE Analysis using USGS data. USGS. 2019. "Material Commodity Summaries 2019", mcs2019\_all.pdf (prd-wret.s3-us-west-2.amazonaws.com). Accessed 22 April 2021.

<sup>25</sup> There is additional lithium in the electrolyte, not included here, which is typically 10 percent of the total cathode lithium.

<sup>26</sup> Class 1 nickel, or very high purity nickel, is the only class of nickel qualified for cathode production.

Figure 4 shows the percentage of lithium, nickel, cobalt, and manganese mined in 2019 that would be needed to support EV sales of 20 percent and 100 percent of U.S. LDV sales. Figure 5 shows the same data except as a percentage of global reserves. As is clearly seen, lithium, cobalt, and Class 1 nickel production will need to increase to support large-volume EV production.

Figure 4. Materials needed for 20 percent and 100 percent (of LDV production) EV production as a percentage of materials mined in 2019.<sup>27</sup>

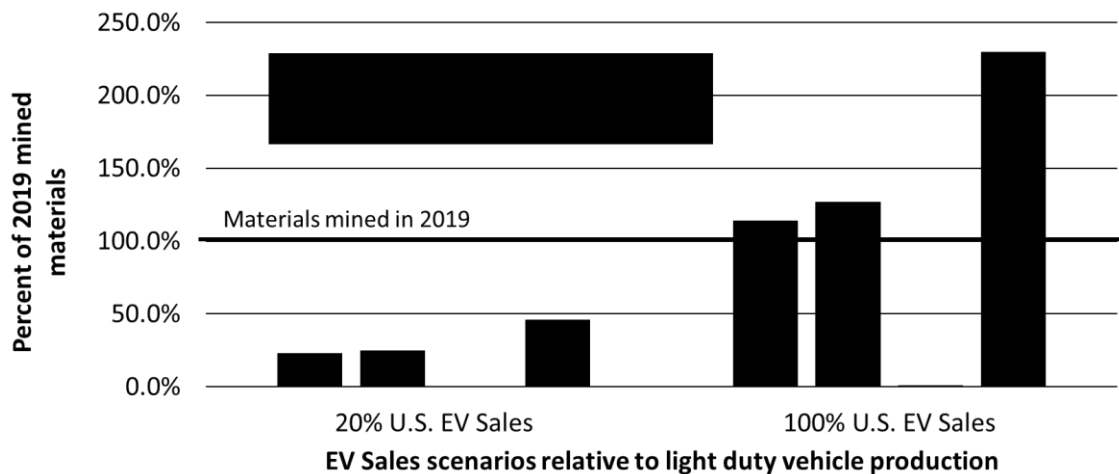
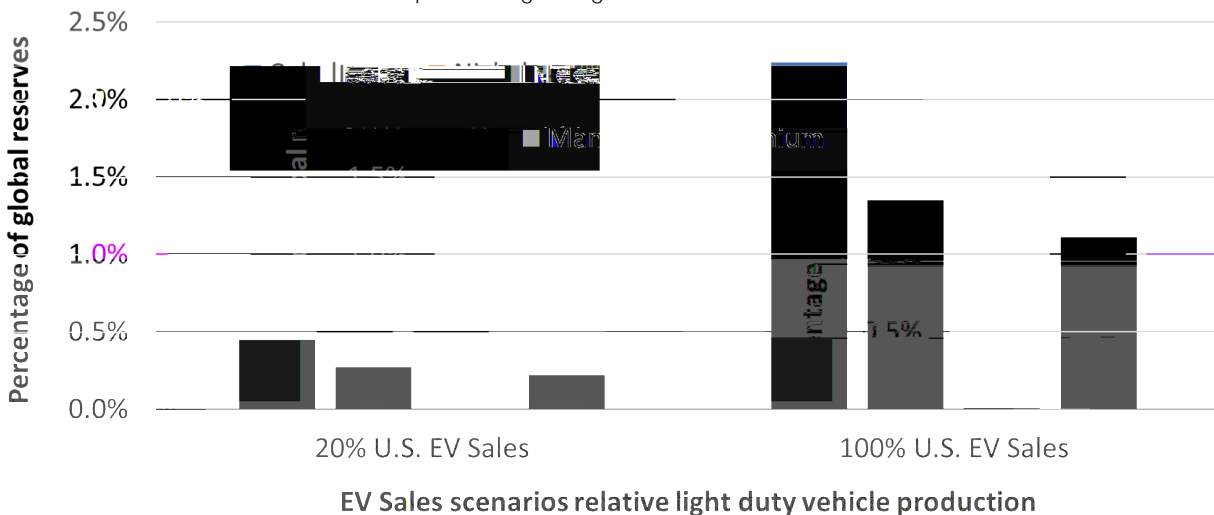

Figure 5. Materials needed for 20 percent and 100 percent (of LDV production) EV production as a percentage of global reserves.<sup>28</sup>



Each of these critical materials faces unique challenges and opportunities. The discussion below addresses the historic and current production, supply chain, and technology, and the proposed strategy for addressing these selected minerals.

<sup>27</sup> DOE Analysis using USGS data. USGS. 2019. “Material Commodity Summaries 2019”, mcs2019\_all.pdf (prd-wret.s3-us-west-2.amazonaws.com). Accessed April 22, 2021.

<sup>28</sup> DOE Analysis using USGS data. USGS. 2019. “Material Commodity Summaries 2019”, mcs2019\_all.pdf (prd-wret.s3-us-west-2.amazonaws.com). Accessed April 22, 2021.

## NICKEL

Nickel is a mineral commodity that ultimately does not have many of the same challenges as lithium and cobalt. While the U.S. is similarly import-reliant, the primary difference stems from nickel imports originating from a diverse set of allied nations – with 68 percent coming from Canada, Norway, Australia, and Finland. The supply chain for nickel overall appears more stable than lithium and cobalt when assessed using the metrics in the critical materials framework; however, the supply chain for Class 1 nickel sulfate faces more challenges. There are market indications that there could be a large shortage of Class 1 nickel in the next 3-7 years. If there are opportunities for the U.S. to target one part of the battery supply chain, this would likely be the most critical to provide short- and medium-term supply chain stability. In contrast to cobalt, nickel content per battery will increase in the coming years, as R&D focused on high-nickel in cathodes has shown significant and accelerated commercial adoption. The potential shortfall from this increase in demand poses a supply chain risk for battery manufacturing globally, not just in the United States; given the pervasive need, the established nickel industry is ramping up production and processing, and the United States is falling further behind China in this critical material.

The nickel market has a high purity commodity that is “Class 1”, needed by battery materials manufacturers, that can be targeted for strategic U.S. investment, provided efforts are well-coordinated with allied partners like Australia and Canada so that the United States does not establish overcapacity in this area. However, there is urgency to developing a strategy around Class 1 nickel, as there are already multibillion-dollar Chinese investments in Indonesia, home to one-quarter of the overall global reserves.

### Historical View:

Global nickel mine production increased from 0.92 million metric tonnes (Mt)<sup>29</sup> of nickel content in 1995 to 2.61 Mt in 2019. Historically, Indonesia and the Philippines were the top nickel mine producing countries. Other notable nickel mine producing countries include Australia, Brazil, Canada, New Caledonia, and Russia.<sup>30</sup> For refined nickel, global production increased from approximately 2 Mt of nickel content in 2013 to approximately 2.4 Mt in 2019, with China dominating global production from 2013 to 2019. Other notable refined nickel producing countries include Indonesia, Japan, Russia, and Canada.<sup>31</sup>

The United States has historically relied on imports to meet its nickel demand. Most domestic mining and smelting operations ceased in the late 1990s. In 2014, mining started at Eagle Mine in Michigan to produce nickel concentrate, which was exported.<sup>32</sup> Eagle Mine is the only active nickel mine in the U.S. today, and its lifetime is set to end in 2025. As of 2021, Canadian-owned PolyMet Mining Corp. is fully permitted to develop the NorthMet Mine in Minnesota; however, legal battles over the site's development are currently ongoing. Nickel recycling has occurred since the 1970s and still plays an important role, though it is unclear what impact it will have on Class 1 nickel supply.

### Today's View:

In 2021, total global nickel reserves are estimated at approximately<sup>94</sup> Mt of nickel content. Of that, Indonesia and Australia each have approximately 20 Mt, followed by Brazil at 16 Mt. The U.S. nickel deposits are small, with low nickel content. The USGS estimates that global nickel mine production in 2020 is 2.5 Mt of nickel content, and that the United States produces 0.016 Mt.<sup>33</sup>

Nickel is mostly used for producing stainless steel, aerospace superalloys, catalysts, and batteries. Although stainless steel production is expected to continue to dominate global nickel demand through 2040, nickel use

---

<sup>29</sup> Mt = 1 million tonnes = 1 million metric tons

<sup>30</sup> USGS “Mineral Commodity Summaries” from 1996 through to 2021.

<https://www.usgs.gov/centers/nmic/mineral-commodity-summaries>. Accessed 23 April 2021..

<sup>31</sup> Roskill. *Lithium: Outlook to 2030, 17th Edition*. (2020). <https://roskill.com/market-report/lithium/>

<sup>32</sup> USGS “Mineral Commodity Summaries” from 2014 through to 2021.

<https://www.usgs.gov/centers/nmic/mineral-commodity-summaries>. Accessed 23 April 2021.

<sup>33</sup> USGS. 2021. “Material Commodity Summaries 2021”, <https://pubs.usgs.gov/periodicals/mcs2021/mcs2021.pdf>

in the form of nickel sulfate (NiSO<sub>4</sub>) for batteries is expected to play an increasingly important role. As the industry moves away from cobalt in cathodes, the trend is to substitute it with nickel. This demand creates supply chain challenges to produce enough nickel sulfate from Class 1 nickel sources and is the reason why nickel is less concerning overall in the critical materials list, but more so when applied specifically to batteries.

Cathodes for lithium-ion batteries use only Class 1 nickel, which contains a minimum of 99.8 percent nickel. Class 1 nickel can be processed from any input stream of nickel, but is most economical from nickel sulfide deposits and, to a lesser extent, nickel laterites (a form of oxide). This distinction is critical, especially when looking at the amount of nickel being produced today and how much is needed for EVs. Currently, there is sufficient nickel in the ground to support large volume EV production, but not nearly enough processing capacity to make the needed amount of Class 1 nickel.<sup>34</sup>

Indonesia is expected to dominate nickel ore production through 2040. To promote its processing, Indonesia banned nickel ore exports starting in January 2020. In response to the ban, multiple nickel refining projects with a combined capacity of 0.42 Mt per year as of 2020 are under construction in Indonesia, with investment from multiple Chinese companies and one Japanese company.

### **Supply Chain and Technology:**

Global nickel sulfate demand is expected to increase from approximately 0.2 Mt of nickel content in 2020 to approximately 3 Mt in 2040. Nickel sulfate production cost depends on the feedstock type and the production region. In general, production from matte is the most economic, followed by mixed hydroxide precipitate production and recycling. Battery residue and scraps are expected to account for over half of the global nickel sulfate feedstock by 2040.

Lithium-ion batteries are expected to account for over 90 percent of global nickel sulfate consumption by 2030. Additionally, nickel can be recovered from unconventional and secondary sources by remediating mine sites. For example, the Mount Storm small-scale project in West Virginia, expected to come online in fall 2021, could recover as much as 1 tonne-per-year of nickel-oxide.

### **Substitutes:**

As mentioned above, nickel is currently used in most EV battery cathodes. There is an emerging desire among some automotive and battery companies to reduce the amount of nickel in EV battery cathodes due to anticipated supply issues when EV sales reach tens of millions per year. DOE is planning to address the associated R&D issues with low/no nickel cathodes in upcoming research programs. Some current and next generation cathodes that do not rely on nickel include LiFePO<sub>4</sub>, LiMn<sub>2</sub>O<sub>4</sub>, disordered rock salt cathode compounds, sulfur, CuF<sub>2</sub>, and Li<sub>2</sub>FeSiO<sub>4</sub>.

## **LITHIUM**

### **Historical View:**

Lithium was first discovered around 1800 and had little use outside of pharmaceutical and ceramic glazes until after World War I, when Germany used it in lead bearings. Lithium was first used for nuclear weapons by the United States during the Cold War, leading to production during that time for strategic purposes.<sup>35</sup> Kings Mountain, North Carolina is a major lithium source with ore deposits. Cheaper brine-based deposits were discovered in South America in the 1980s,<sup>36</sup> while Australian ore deposits of lithium made a major shift

---

<sup>34</sup> McKinsey and Company. *Basic Materials*. “The Future of Nickel: A Class Act”. November 2017. <https://www.mckinsey.com/~media/McKinsey/Industries/Metals%20and%20Mining/Our%20Insights/The%20future%20of%20nickel%20A%20class%20act/The%20future%20of%20nickel%20A%20class%20act.ashx>. Accessed 23 April 2021.

<sup>35</sup> U. Wietelmann and M. Steinbild, in *Ullmann's Encyclopedia of Industrial Chemistry*, 7th edn., 2014.

<sup>36</sup> Bomgardner, Melody M. “Albemarle to double US lithium output.” *Chemical and Engineering News* (January 31, 2021). <https://cen.acs.org/energy/energy-storage-/Albemarle-double-US-lithium-output/99/web/2021/01>

into the battery market in 2017.<sup>37</sup> Today, about 89 percent of Australian lithium is shipped to China for refining.<sup>38</sup>

### Today's View:

The USGS estimates that batteries make up 71 percent of the end-use lithium market.<sup>39</sup> As the name suggests, lithium is considered the only truly non-replaceable element in lithium batteries. Lithium can be recovered from lithium-containing ores (e.g., spodumene), salt-lake brines, clays, and seawater.<sup>40</sup> In 2021, the USGS indicates that there are 21 million tonnes of economical lithium reserves of varying forms. USGS uses metric tons, or tonnes, for all reserves and mining numbers. The most notable reserves are concentrated in Chile (44 percent), Australia (22 percent), Argentina (9 percent), China (7 percent), U.S. (3.5 percent), Canada (2.5 percent), and several other countries comprising the remaining left (12 percent) (Figure 6 left).<sup>41</sup> Figure 6 right shows 2020 lithium extraction by country.<sup>42</sup> Globally, brines account for 66 percent of lithium resources while ore deposits account for 26 percent.<sup>43</sup> In 2017, lithium production increased sharply due to new Australian operations. Lithium refining into lithium carbonate and lithium hydroxide is dominated by China, followed by Chile.

Figure 6. 2020 Lithium Reserves (left) and Estimated Production (right).<sup>44</sup> (kt = 1000 tonne = 1000 metric tons)

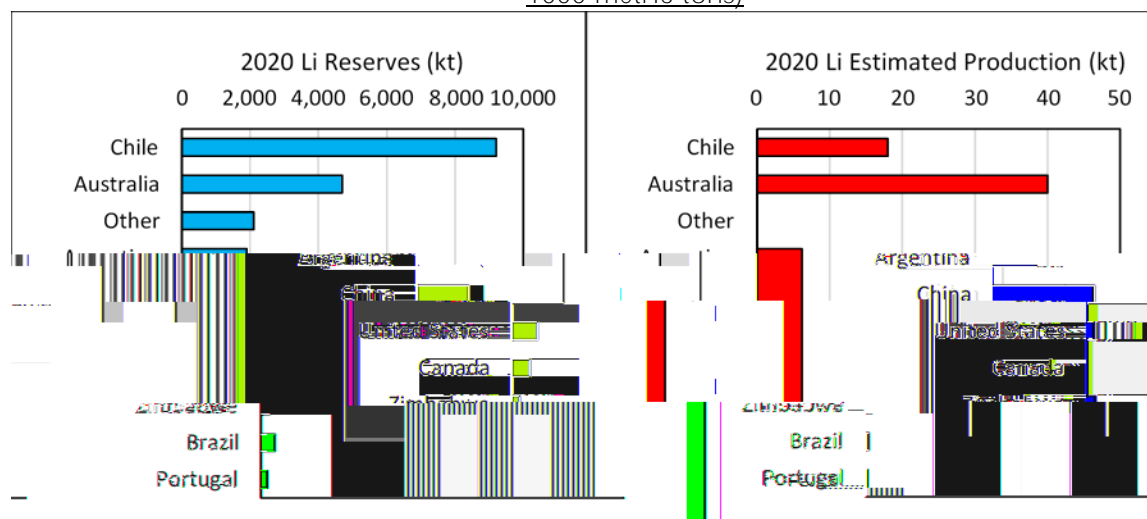

Brine and some ore positions are the most economical lithium sources.<sup>45</sup> World lithium prices were stable through the first half of the 2010s at around \$5,000-\$7,000/tonne, but experienced a demand boom in 2016,

<sup>37</sup> USGS. 2017. “Minerals Yearbook”, <https://www.usgs.gov/centers/nmic/lithium-statistics-and-information>

<sup>38</sup> Austrade. Australian Government, “The Lithium-Ion Battery Value Chain – New Economy Opportunities for Australia”, Page 16. <https://www.austrade.gov.au/ArticleDocuments/5572/Lithium-Ion%20Battery%20Value%20Chain%20report.pdf.aspx>. Accessed, May 5, 2021.

<sup>39</sup> USGS. 2021. “Mineral Commodity Summaries 2021”, <https://pubs.usgs.gov/periodicals/mcs2021/mcs2021.pdf>

<sup>40</sup> U. Wietelmann and M. Steinbild, in *Ullmann’s Encyclopedia of Industrial Chemistry*, 7th edn., 2014.

<sup>41</sup> USGS. 2021. “Mineral Commodity Summaries 2021”, <https://pubs.usgs.gov/periodicals/mcs2021/mcs2021.pdf>

<sup>42</sup> USGS. 2021. “Mineral Commodity Summaries 2021”, <https://pubs.usgs.gov/periodicals/mcs2021/mcs2021.pdf>

<sup>43</sup> PW Gruber. *Journal of Industrial Ecology. Research and Analysis, Global Lithium Availability: A Constraint for Electric Vehicles?*. 2011. [http://litio.ipg.pt/wp-content/uploads/2018/07/Global-lithium-availability-A-Constraint-for-Electric-Vehicles\\_2011.pdf](http://litio.ipg.pt/wp-content/uploads/2018/07/Global-lithium-availability-A-Constraint-for-Electric-Vehicles_2011.pdf). Accessed May 3, 2021.

<sup>44</sup> USGS. 2021. “Mineral Commodity Summaries 2021”, <https://pubs.usgs.gov/periodicals/mcs2021/mcs2021.pdf>

<sup>45</sup> Roskill. *Lithium: Outlook to 2030, 17th Edition*. (2020). <https://roskill.com/market-report/lithium/>

causing prices to reach \$25,000/tonne.<sup>46</sup> In 2017, Australia's Greenbushes mine came online, doubling worldwide production and leading to a price drop to \$20,000/tonne.<sup>47</sup>

### **Supply Chain and Technology:**

Currently, the most economical source for lithium is from brines, mainly located in Argentina and Chile. Economic characteristics are governed by lithium concentration, composition (i.e., the magnesium/lithium ratio), and local climate. As noted, a large majority of lithium processing currently occurs in China, with essentially none in the United States.

In North America, the Mexican-based Sonora clay lithium deposit, operated by China-based Gangfeng Lithium, is currently under development, and would increase total lithium production by about 35,000 tonnes of lithium annually, or roughly half of today's production.<sup>48</sup> The world's total annual production is currently 82,000 tonnes.<sup>49</sup>

Additionally, the United States has seen some movement on domestic lithium projects. Deposits in Kings Valley, Nevada (the Thacker Pass lithium deposit) have 2 Mt of lithium, while the Kings Mountain Belt, North Carolina has about 2.8 Mt of lithium.<sup>50</sup> However, Tribes and other nearby residents have raised concerns about the impact of the proposed development at the Kings Valley deposit on cultural resources, wildlife, and water supplies.<sup>51</sup> The Thacker Pass lithium project is in the permitting process, with a recently completed National Environmental Policy Act (NEPA) Environmental Impact Statement. Tesla has acquired 10,000 acres of lithium clay deposits in Nevada and has plans to produce lithium hydroxide in Texas. In Arkansas, the Smackover project (by Standard Lithium and Lanxess) forecasts up to 20,900 tonnes per year of battery-quality lithium carbonate.<sup>52</sup> In Wyoming's Rock Springs Uplift, a saline storage well drilled in 2013 found lithium and estimates of 18 Mt could be over 2,000 square miles.<sup>53</sup> Rio Tinto has begun production of Class 1 lithium from mining waste at a demonstration plant in CA. The demonstration will be run in 2021 with a capacity of 10 tonnes per year, with plans to scale production to more than 5,000 tonnes per year.<sup>54</sup>

### **COBALT**

Cobalt has been essential to the introduction of the lithium-ion battery since lithium cobalt oxide was first discovered in the 1970s by Nobel Laureate John Goodenough as the first crystal structure that can allow for lithium ions to flow in and out of it while maintaining its structure. Since then, the development and commercialization of lithium-ion batteries and almost every cathode chemistry discovered has had some cobalt content. The primary supply chain concern with the existing cobalt supply stems from the combined issues that over half of the reserves of cobalt exist in the DRC, where alleged mining and labor conditions are well outside of international practice, and that China has a dominant position in cobalt mining and processing of materials extracted from the DRC. Though the United States ranks 10<sup>th</sup> globally in cobalt reserves, there is almost 65 times more cobalt reserves in the DRC than in the United States.

---

<sup>46</sup> European Metals. Lithium. <https://www.europeanmet.com/lithium/>. Accessed May 3, 2021.

<sup>47</sup> European Metals. Lithium. <https://www.europeanmet.com/lithium/>. Accessed May 3, 2021.

<sup>48</sup> Mining. "Ganfeng ups stake in giant Mexico lithium clay project." February 1, 2021.

<https://www.mining.com/ganfeng-signs-new-jv-agreement-for-sonora/>. Accessed April 14, 2021.

<sup>49</sup> USGS. 2021. "Mineral Commodity Summaries 2021", <https://pubs.usgs.gov/periodicals/mcs2021/mcs2021.pdf>. Accessed April 14, 2021

<sup>50</sup> U. Wietelmann and M. Steinbild, in *Ullmann's Encyclopedia of Industrial Chemistry*, 7th edn., 2014. <https://onlinelibrary.wiley.com/doi/book/10.1002/14356007>. Accessed April 14, 2021.

<sup>51</sup> High Country News, Mining. "Nevada lithium mine kicks off a new era of Western extraction". February 18, 2021. <https://www.hcn.org/issues/53.3/indigenous-affairs-mining-nevada-lithium-mine-kicks-off-a-new-era-of-western-extraction>. Accessed April 14, 2021.

<sup>52</sup> NS Energy. Arkansas Smackover Lithium Project, Arkansas, USA ([nsenergybusiness.com](http://nsenergybusiness.com)). Accessed April 14, 2021.

<sup>53</sup> Business Insider. New Wyoming Lithium Deposit ([businessinsider.com](http://businessinsider.com)). Accessed April 14, 2021.

<sup>54</sup> Business Wire. "Rio Tinto achieves battery grade lithium production at Boron plant", April 7, 2021. <https://www.businesswire.com/news/home/20210407005321/en/>. Accessed April 14, 2021.

Cobalt represents one of the most comprehensive ways China has gained a competitive advantage in the critical materials landscape for batteries. China has just over 80,000 tonnes of reserves, and only 6 times the mining output of the United States,<sup>55</sup> but controls 72 percent of the capacity for refinement of the 162,900 tonnes that are mined each year.<sup>56</sup> As a comparison, the United States has 55,000 tonnes of reserves.<sup>57</sup> The viability for the United States to maintain a foothold in this commodity rests less on the potential of individual mines, but rather in the relationship between mining and refining capacity within a country or market, as is exemplified in the success of the Chinese approach. Cobalt represents one of the examples of why, ultimately, the United States is unable to solve these issues with R&D alone, and why there needs to be a concerted approach toward diplomatic efforts, supply chain mapping, ethical sourcing, and environmental policy.

### **Historical View:**

Cobalt was first produced in 1735 and was first used primarily as a colorizing agent. In the early 1900s, research on cobalt alloys was underway, and by 1941, the first turbo superchargers were produced from cobalt-based alloys. In the 1930s, magnet applications of cobalt were also emerging. Cobalt production generally occurs as a byproduct of other metal mining, often copper. However, cobalt was produced as a primary product in Idaho from 1942 to 1952. Historical U.S. cobalt production has also been associated with platinum group metals, lead, and zinc production. Pennsylvania has been a significant source of cobalt for U.S. domestic production, and researchers are exploring opportunities to produce cobalt from industrial wastes, such as acid mine drainage and other mine-impacted waters, mine tailings and other mine wastes, and coal mining waste measures.

Global cobalt mine production increased from approximately 20,000 tonnes of cobalt metal content in 1970 to approximately 140,000 tonnes in 2017, while global refined cobalt production increased from approximately 20,000 tonnes of cobalt metal content to approximately 120,000 tonnes over the same period. The DRC dominates global cobalt mine production. Other notable cobalt mine producing countries include Australia, Zambia, New Caledonia, Russia, and Canada. For refined cobalt, the DRC dominated global production from 1972 to 1992, while China dominated production from 2005 to 2017 due to their significant investment in processing capacity. Other notable refined cobalt producing countries include Finland, Canada, and Australia.<sup>58</sup>

### **Today's View:**

In 2021, the global reserves of cobalt are estimated at 7.1 Mt, with more than 50 percent (3.6 Mt) concentrated in the DRC. Australia has almost 20 percent (~1.4 Mt) of global cobalt reserves, with no other country having more than 7 percent. The U.S. cobalt reserve is estimated at 0.053 Mt.<sup>59</sup> The USGS estimates that global cobalt mine production in 2020 is 140,000 tonnes of cobalt content, and that 70 percent of all mined cobalt comes from the DRC, with Russia as the next highest producer at 5 percent.<sup>60</sup>

---

<sup>55</sup> USGS 2021. "Cobalt Statistics and Information". <https://pubs.usgs.gov/periodicals/mcs2021/mcs2021-cobalt.pdf>. Accessed May 3, 2021.

<sup>56</sup> NREL Analysis of Data Sourced from BloombergNEF Batteries Mineral Database, Available for purchase. Accessed March 17, 2021.

<sup>57</sup> USGS 2021. "Cobalt Statistics and Information". <https://pubs.usgs.gov/periodicals/mcs2021/mcs2021-cobalt.pdf>. Accessed May 3, 2021.

<sup>58</sup> USGS 2021. "Cobalt Statistics and Information". <https://pubs.usgs.gov/periodicals/mcs2021/mcs2021-cobalt.pdf>. Accessed May 3, 2021.

<sup>59</sup> USGS. 2021. "Mineral Commodity Summaries 2021". <https://pubs.usgs.gov/periodicals/mcs2021/mcs2021.pdf>. Accessed May 3, 2021.

<sup>60</sup> USGS. 2021. "Mineral Commodity Summaries 2021", <https://pubs.usgs.gov/periodicals/mcs2021/mcs2021.pdf>

Although the DRC leads in the global mining of cobalt, the vast majority (72 percent) of the global cobalt refining capacity (162,900 tonnes per year) is located in China. In fact, China is the DRC's primary trading partner for cobalt with 84 percent of the DRC's 2019 cobalt exports going to China.<sup>61</sup>

Cobalt is typically recovered as a byproduct of copper or nickel production, thus making its supply partially dependent on the demand for these other elements. At present, 52 percent of the global refined cobalt is used for batteries.<sup>62</sup> Superalloys are also a notable competing end use for cobalt, especially in the United States, where they accounted for 43 percent of domestic cobalt consumption in 2020.<sup>63</sup>

### **Supply Chain and Technology:**

Demand for cobalt for batteries is estimated to grow from less than 0.1 Mt in 2020, to 0.15-0.7Mt (a 50-700 percent increase) in 2040, depending on how the global EV market and EV battery chemistry evolves.<sup>64</sup> Cobalt materials can be recovered from the recycling of spent batteries and catalysts. As the global EV fleet continues to grow and the cobalt content in batteries continues to decrease, spent EV batteries and consumer electronic batteries could become an increasingly important source for future cobalt supply to the battery supply chain. It has been estimated that EV battery recycling alone can reduce cumulative cobalt demand for global EV fleets through 2050 by 26-44 percent.<sup>65</sup>

Previous cobalt mining and refining waste (e.g., tailings and slags) can also be a potential resource for cobalt, as 40-60 percent of the ore cobalt content is estimated to be lost in the ore processing and refining processes. Cobalt recovered from unconventional and secondary sources throughout U.S. basins, such as the Appalachian Basin, could be a very significant source recovered from remediation and reclamation of legacy sites. Resource estimates are being conducted, however, in Pennsylvania, cobalt grades range from 200-6,800 parts-per-million and a West Virginia small-scale acid-mine-drainage project is planning for one ton per year of cobalt recovery. It is expected that cobalt demand can be met through a combination of increased recycling and non-marine production.

### **Substitutes:**

Nearly all EV battery cathodes contain a combination of nickel, manganese, and cobalt. Many battery manufacturers have ambitious goals to move to low- or no cobalt- cathodes. Often, this lowering of cobalt content is achieved by substitution of more and more nickel or manganese. It is important to note, however, that cobalt provides good conductivity and structural integrity, and that higher nickel content can lead to unstable interfaces within the battery cells, which results in poor battery life. Thus, DOE has committed to a multi-year initiative to address the scientific and engineering issues with reducing and eliminating the cobalt in EV batteries and has made very good progress to date. Additionally, some medium and heavy-duty applications (e.g., e-buses) use a cobalt-free LiFePO<sub>4</sub> cathode. Finally, many next generation cathode materials are cobalt-free, which is an active area of R&D being funded by DOE.

## **GRAPHITE**

Graphite, which was the first successfully commercialized anode material for lithium-ion batteries, is still the most widely used material found in lithium batteries. There have been significant efforts to replace graphite with other materials with higher energy density, such as silicon and lithium metal, but there are challenges in these materials and the issue remains a primary ongoing focus for battery R&D. The combination of

---

<sup>61</sup> International Trade Centre. Trade Map. Country: Congo, Partner: China, Product: 26 – Ores, slag and ash, Product Code: 2605 Cobalt ores and concentrates. Trademap.org. Accessed April 30, 2021

<sup>62</sup> Green Car Congress. Cobalt Institute report: demand for cobalt for batteries grew at annual rate of 10 percent between 2013 and 2020 - Green Car Congress, May 2021. Accessed May 25, 2021.

<sup>63</sup> USGS. 2021. "Mineral Commodity Summaries 2021", <https://pubs.usgs.gov/periodicals/mcs2021/mcs2021.pdf>

<sup>64</sup> Xu, C., Dai, Q., Gaines, L. et al. Future material demand for automotive lithium-based batteries. *Commun Mater* 1, 99 (2020). <https://doi.org/10.1038/s43246-020-00095-x>. Accessed April 30, 2021.

<sup>65</sup> Xu, C., Dai, Q., Gaines, L. et al. Future material demand for automotive lithium-based batteries. *Commun Mater* 1, 99 (2020). <https://doi.org/10.1038/s43246-020-00095-x>. Accessed April 30, 2021.



graphite's energy density, surface stability, and cost to produce have been a mainstay for decades, and while there is promise in other materials eventually replacing graphite, graphite remains indispensable.

Two types of graphite are widely used today: natural graphite and synthetic graphite. These two materials have mostly similar properties, with a few key distinctions. Synthetic graphite typically consists of smaller graphene planes and has a better impurity profile. This manifests in a slight decrease (about 10 percent) in energy density and a better lifetime performance for synthetic graphite than natural graphite. There are performance and cost tradeoffs between the two materials and the typical commercial approach is to have a blend of these two materials in the anode. Cost is roughly 50 percent higher at scale for synthetic graphite, but these costs are rapidly decreasing. The United States is positioned as one of the leading suppliers of synthetic graphite, with a strong petrochemical refinement and production industry in place. The DOE is also supporting R&D to convert high carbon content coal derived materials, including coal and coal refuse, into graphite, possibly providing a suitable substitute for use in batteries, with prices comparable to natural graphite.

## **MANGANESE**

Manganese producing countries are South Africa (28 percent of global supply), Australia (18 percent), Gabon (15 percent), China (7 percent), and Brazil (6 percent). Manganese, which is used most by the steel industry, has no domestic production, and the reserves in the United States are considered to be low-grade with high extraction costs. In addition, no single country is likely to establish dominance in the supply of manganese, due to the large geographic base and the distribution of global supply. Manganese, however, could potentially be produced from coal by-products such as acid-mine drainage if needed, which could provide domestic supply. In addition, manganese can be substituted with other elements in the battery's cathode such as aluminum, as illustrated by the successful deployment of the Panasonic-made nickel-cobalt aluminum (NCA) chemistry in Tesla's batteries.

## **COPPER**

Copper is used as a current collector in lithium-ion batteries on the anode side of cells. Copper accounts for approximately 16 percent of the overall materials (by weight) within an individual lithium-ion cell.<sup>66</sup> Chile is the largest producer of mined copper, with Peru, China, DRC, and the United States all contributing major mining productions.<sup>67</sup> In 2020, China refined over 39 percent of all produced copper, with Chile, Japan, DRC, Russia, and the United States contributing refinement production. In addition to the moderate U.S. copper mining (1,200 tonnes) and refining (910 tonnes) production, the United States has a respectable amount of copper reserves, with 48,000 tonnes of reserves quoted by USGS in 2020.

Concerns with copper come primarily from its use across many end-use applications aside from lithium-ion cells, including building construction, electrical and electronic products, transportation equipment, consumer and general products, and industrial machinery and equipment.

The other elements found in high-capacity batteries (e.g., phosphorous, sulfur, fluorine, aluminum, copper and iron) are available in high enough concentrations and in diverse enough locations that they pose less of a potential risk in the lithium-ion battery supply chain, though their supply of Class 1 specific supply and demand require continued monitoring in order to understand potential risks that could arise down the line as well as any potential opportunities for U.S. economic development.

---

<sup>66</sup> Gaines, L., Richa, K., & Spangenberg, J. (2018). Key issues for lithium-ion battery recycling. *MRS Energy & Sustainability*, 5, E14. doi:10.1557/mre.2018.13 <https://www.cambridge.org/core/journals/mrs-energy-and-sustainability/article/key-issues-for-liion-battery-recycling/F37D3914A1F5A8FD0ED3EF901664D126>. Accessed 22 April 2021.

<sup>67</sup> Mineral Commodities Summary, Copper, <https://pubs.usgs.gov/periodicals/mcs2021/mcs2021-copper.pdf>. Accessed 22 April 2021.

## SUBSTITUTES

### Natural Graphite:

Synthetic graphite is increasingly used as a substitute for natural graphite in lithium-ion anodes. Synthetic graphite is a man-made graphite manufactured by high temperature processing of precursor carbon materials. However, today, synthetic graphite costs up to 50 percent more at high volumes than natural graphite. While the precursors that can be used to make synthetic graphite include petroleum, coal, or natural and synthetic organic materials, commercially available synthetic graphite requires needle petroleum coke, which is only produced at a handful of refineries around the world. In short, natural graphite widely can be replaced by synthetic graphite in batteries, including for automotive applications, and can be made in the United States using multiple precursors including some that are widely available and some that are more limited today.

There are additional substitutes for natural graphite beyond synthetic graphite, including silicon, tin, lithium titanate, and pure lithium metal. Note that some of these substitute anodes do not yet provide the performance to make them commercially acceptable, thus further R&D is underway and they are not near- or intermediate-term options. For more information on silicon anodes for use in place of graphite anodes, see the *Emerging Technologies* section.

### Manganese:

As mentioned above, manganese is used in many EV battery cathodes. There is currently no concerted effort to replace or remove manganese. In fact, manganese may emerge in next generation cells as a preferred element given its low cost, abundance, the fact that many manganese-based cathodes are relatively safe. In addition, if manganese were to become a supply chain concern, there are numerous current and next generation cathodes that do not rely on manganese, such as  $\text{LiFePO}_4$ , sulfur,  $\text{CuF}_2$ , and  $\text{Li}_2\text{FeSiO}_4$ .

## RECYCLING

Recycling of lithium-ion batteries presents one of the major challenges and opportunities for the United States to bolster its battery supply chain. However, the costs associated with end-of-life batteries make recycling unprofitable in many cases today – largely driven by the elemental value of the material, distance to a recycling center, recycling center utilization, and product yield from recycling. Some of these challenges can be addressed by promoting collection and reducing the cost of collection and transportation of recyclable material, allowing the U.S. to develop commercial scale recycling capacity on par with China or the EU. In the longer-term, new technologies will expedite cost-effective recycling.

The current lithium-ion battery recycling methods (hydrometallurgical and pyrometallurgical) are effective; however, they only enable the recovery of specific metals, and in material forms that are of low value. Using these processes, the value from recycling lies primarily in the feedstock's cobalt content and to a lesser extent its nickel, although some recyclers do recover lithium.<sup>68</sup> Some lithium-ion battery cathode chemistries do not have viable pathways for profitable recycling using current commercial methods (e.g., lithium iron phosphate batteries, though these are also not widely used domestically). However, consumer electronics batteries are profitable under most recycling processes due to their cobalt content.

To make lithium-ion recycling profitable for all cathode chemistries, and to encourage industry growth, new recycling methods must be developed. The challenges to commercially scale recycling require additional RD&D over the coming years. For example, there is a potential market opportunity in direct cathode to cathode recycling, where the cathode powder remains intact at the mixed metal and is put directly into new batteries, but this technology is not currently market ready. Addressing profitability challenges through RD&D will become increasingly important in the coming years, as the decreasing cost of batteries decreases

---

<sup>68</sup> Study of Large Format EV Lithium-Ion Battery Recycling in China, Avicenne Energy for NAATBatt International. December 2018. Accessed April 15, 2021.

front-end value, straining recycling economics by directly impacting the value captured from end-of-life batteries.

### **Recycling Process Descriptions:**

Smelting (pyrometallurgy) treats the input (batteries or black mass) as if it were an ore, exposing it to high temperature (over 1100°C) to melt or burn the components of the cell. The valuable product is a mixed alloy of cobalt, nickel, and copper, with the lithium and aluminum material being lost to the process slag in most cases. This type of process is commercially mature, yet energy intensive, and is used to process metals such as iron and copper on a large scale.

Hydrometallurgy, or leaching, is commercial at a large scale in China and Korea and converts a mixture of cell chemistries into product that can be reintroduced as cathode precursors. In this process, the majority of the battery components can be recovered as metals (copper, aluminum) or salts (lithium, nickel, cobalt, manganese, etc.), making this a low loss process.

Direct recycling is the recovery, regeneration, and reuse of battery components directly without breaking down their chemical structure. This recycling process provides the quickest pathway for cathode powder and other materials to get back into the battery supply chain. This method of recycling is still in the R&D stage, and additional work is needed to make direct recycling a profitable process. If initiated today, the input for direct recycling would largely consist of first-generation Leaf, Volt, and Tesla models, all of which have changed in composition and increased in energy storage capacity over time. Within this area of research, there is some potential in upcycling, which allows for flexibility to change the cathode composition without being completely broken down into the constituent salts, which is considered the long-term R&D goal in this area.

There are many companies, both in the United States and abroad, using these and other technologies within the recycling supply chain; however, it remains a challenge to cost-competitively recover anything other than the high-value cobalt and nickel constituents.

Until recently, almost all the end-of-life lithium-ion batteries were from portable consumer electronic devices. As EV deployments continue to grow, large EV batteries will dominate the supply of end-of-life material (see Figure 7).

Figure 7. Projected U.S. Battery Demand.<sup>69</sup>

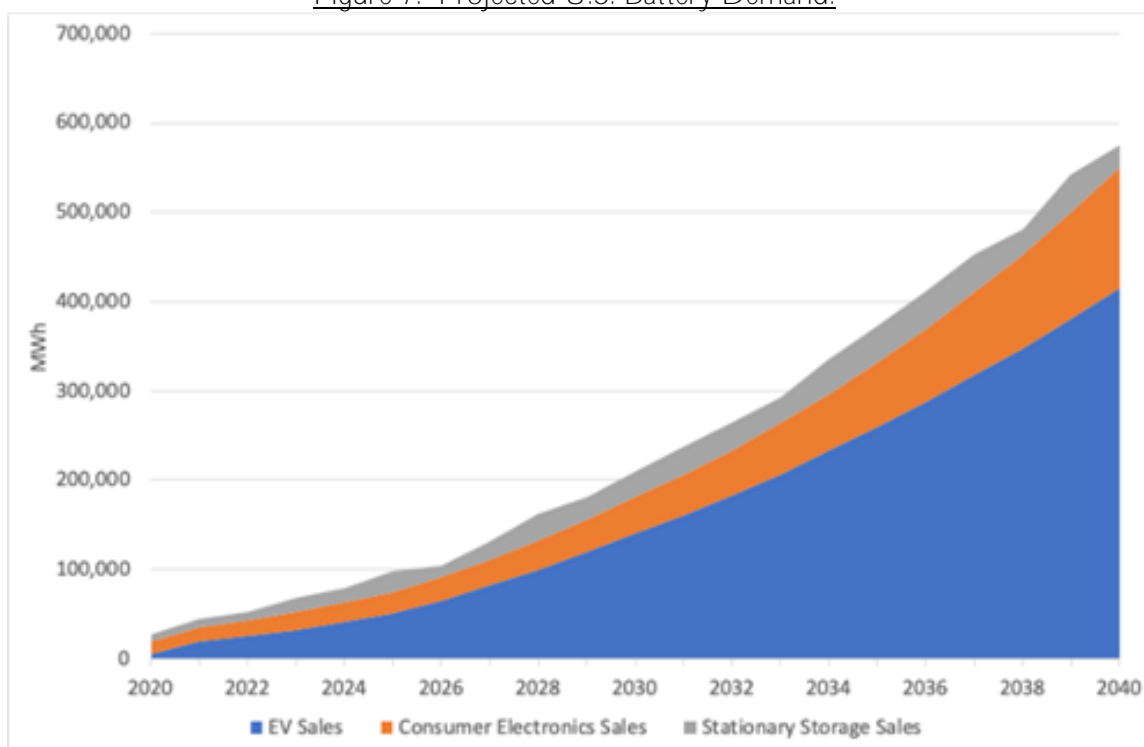

Approximately 29,000 tons of lithium batteries were available for recycling in the United States in 2019, nearly all from consumer electronics. The dominant cathode type in these cells was lithium cobalt oxide.<sup>70</sup> Many firms collect spent batteries in the United States and direct them to appropriate recyclers. In 2019, three firms handled about 15 percent of the material that was available to be processed, so reports indicating recycling rates of approximately 5 percent are incorrect. However, although some battery recycling steps (preprocessing) occur in the United States, it is believed that nearly all the valuable materials are currently recovered outside of the United States. Domestic economical recycling could reduce exports of this valuable resource and increase the quantity available to the U.S. battery supply chain.

During cell manufacture, production scrap is a key source of material for recycling.<sup>71</sup> Scrap represents a useful scale-up for many recycling processes, as it can use battery materials at various levels of deconstruction and test separation methods. Manufacturing scrap is available immediately and it is simpler to process than spent batteries. Although it may be composed of trimmings or rejected product from several process steps, it contains fewer components than spent batteries and has a known composition. Recovered cathode from manufacturing scrap has been demonstrated to perform well in new cells without any processing to upgrade it. Scrap is the initial feedstock for new North American recyclers like Redwood Materials, Li-Cycle, and American Manganese (a Canadian firm).

<sup>69</sup> BloombergNEF 2020. *Long Term Electric Vehicle Outlook 2020*.

Avicenne Energy, C. Pillot. “The rechargeable battery market 2017-2025”, The Battery Show, Germany, May 15, 2018.

BloombergNEF 2019. *Long Term Energy Storage Outlook 2019*.

IEA 2020. *Global EV Outlook 2020*, <https://www.iea.org/reports/global-ev-outlook-2020>.

<sup>70</sup> Circular Energy Storage Research and Consulting. *The Lithium-ion Battery Life Cycle Report 2021*. London, UK, 2020. <https://circularenergystorage.com/reports>. Accessed March 5, 2021.

<sup>71</sup> Ivan, “Tesla Battery Day Preview-Redwood Materials,” YouTube video, 8:50, EV Stock Channel, September 5, 2020, <https://www.youtube.com/watch?v=EWRvmFR8vKc>, Time mark: 5:55. Accessed March 5, 2021.

Figure 8. Proportion of nickel and cobalt required for new batteries that could be met with metals recovered from recycled batteries.<sup>72</sup>

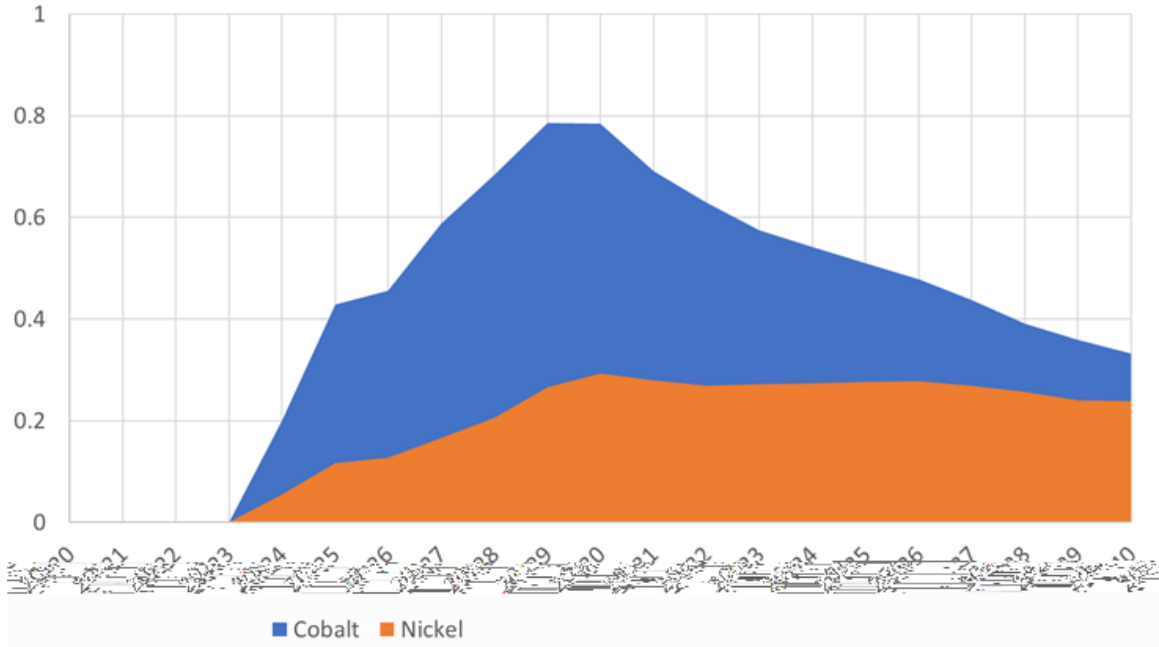

Figure 8 presents the proportion of nickel and cobalt required for new batteries that could be met with metals recovered from recycled batteries. Today's recycling stream has low nickel content, and as battery chemistries are moving towards higher nickel content, there will continue to be a shortfall of nickel from the recycling stream. As new battery chemistries are adopted and domestic battery manufacturing and recycling capabilities come online, the cobalt and nickel supply chain should be re-examined.

Recycling of manufacturing scraps could be an important step for U.S. industry. The scrap from the new and potentially large U.S. cell manufacturing would be available for immediate processing, while the cells from those factories being used in EV products would not enter the recycling stream for 10 years or more.

**Factors Affecting Recycling:**

The ability for the U.S. to compete in the recycling space will largely depend on an increase in the collection of end-of-life batteries. Wide-scale collection of end-of-life batteries helps secure a reliable supply of inputs into recycling facilities, supporting high utilization that is critical to commercially viable recycling.

Beyond rates of collection, recyclers face cost pressures that largely stem from transporting batteries safely long distances to a recycling center, the number of sorting and evaluation steps end-of-life batteries go through before recycling, and the costs of operating the recycling process itself. The increasingly complex disassembly required and the weight of the e-waste it is often transported with create additional weight and disposal requirements. When balanced against the elemental value of the recoverable product coming out of the process, small scale or start-up recycling faces significant challenges. The ability for the United States to compete in this area will largely depend on increasing the collection of these batteries, as utilization of facilities and the predictability of the collection of end-of-life batteries can significantly swing the market.

<sup>72</sup> NREL Analysis in the LIBRA Model with data from the following sources: BloombergNEF 2020. *Long Term Electric Vehicle Outlook 2020*. Available for purchase. Avicenne Energy, C. Pilot. "The rechargeable battery market 2017-2025", The Battery Show, Germany, May 15, 2018.

## Collection:

There are many factors impacting the collection rates for recycling. Some of these challenges may be solved by new technical approaches like building collection sites that can safely store batteries and simplifying safe packaging of those batteries for transportation as universal waste. Others may require policy work. There is no national regulatory structure for lithium batteries. Rather, states and localities have enacted a patchwork of rules and regulations. For EVs, there is no established protocol or industry best practices on how best to collect these batteries at end of life and transport them to a recycling center; many batteries that remain in garages and in homes are not sent for collection. Owners also cite concerns over data security of the product or a lack of knowledge regarding proper disposal.

In the United States, the consumer owns the EV battery and is responsible for it at end-of-life, in contrast to the EU, where the responsibility for proper disposition rests with the automaker. The EU model places the disposition requirement with the OEMs, which means they still "own" some aspect of the vehicle after purchase and after warranty period. If this were incorporated in the United States, it would considerably change the vehicle ownership landscape, as it could limit the consumer's ability to resell their vehicle. The OEM requirement-based model would also require some mechanism for enforcement or validation for companies to be in good standing on meeting recycling rates. In one alternative model being explored for use in electric buses, the OEM leases the batteries on sold buses, receives the batteries back at end-of-life, and develops plans to reuse them for storage in charging stations. The electric bus OEM contracts with a recycling firm for eventual recycling of these batteries. More analysis is required to determine the overall impact of this and other models on EV adoption, collection rates, and recycling rates, among other important factors. As EV penetration grows, the scale of the lost opportunity will grow as well without policy support to address current collection challenges.

## Transportation of Material:

Used lithium-ion batteries are considered Class 9 hazardous material for transportation because of potential safety risks. Shipments of materials in this class must meet special packaging requirements and are charged higher rates. According to an analysis done by the EverBatt team (Technoeconomic Analysis/Life Cycle Assessment model), Figure 9 left, transportation is the second-largest cost in the recycling process. Regulatory complexity causes confusion among stakeholders as to whether batteries should be treated as hazardous waste or universal waste. In addition to policy action, future innovations could render batteries electrochemically inert, allowing the waste to be re-classified as non-hazardous. This would aid in reducing transportation costs to make the overall recycling process more profitable.

Figure 9. Cost breakdown of recycling for lithium-ion batteries based on 1000 miles from collection site to the recycling centers.<sup>73</sup>



<sup>73</sup> EverBatt analysis from Argonne National Laboratory. 2020.

### *The Importance of Exports*

Without sufficient end-of-life collection and recycling, the United States will lose the opportunity to convert demand for products with batteries into a critical material supply, and will instead landfill or export the critical materials in those batteries as waste. Additionally, while domestic recycling capacity is important, without critical material refining and processing and battery manufacturing capacity, the captured materials from recycling end-of-life batteries will be exported for processing at foreign facilities and re-imported in the form of processed or manufactured products. As an example, though nickel sulfate is created from domestic recycling processes today, it is largely exported to China since there is very little demand to buy the product at the scale produced by recycling in the United States.

If products containing these critical materials are exported after initial use for downcycling, there is the potential that this increased utility on the design life of the product could result in secondary environmental effects and materials lost to landfilling. As an example, about 94,000 of the approximately 500,000 Nissan Leafs ever produced as of 2019 were registered in Ukraine, Georgia, Jordan, New Zealand, and Sri Lanka.<sup>74</sup> The practice of exporting refurbished U.S. products is common in consumer electronics. For example, used cell phones are commonly exported for re-use in developing countries that ultimately might not have sufficient infrastructure or policies around recycling and could have negative long-term effects on material availability.

### **Impact of Recycling on Supply Chain Security:**

In the short term, the long lifespan of EV batteries and the scale of EV deployment to date mutes the impact of limited domestic recycling capacity. In addition, there is variability for when these batteries will reach their end-of-life that is hard to predict as well as changing demand given ongoing R&D to identify earth abundant substitutes (e.g., for cobalt). Despite these uncertainties, recycled material can serve to buffer volume and price instabilities. However, in the long-term, when a large supply of EV batteries reach end-of-life, recycling could eventually supply a significant share of critical battery material needs as part of a circular economy.

### **Cell Component Market**

Major battery cell components include cathodes, anodes, electrolytes, and current collectors. These components are sealed in battery cells and placed into packs through the pack fabrication process. The cathode and anode are the largest weight percent of the battery, comprising roughly a third of overall weight. Binder materials and conductive additives help anodes and cathodes achieve the particle adhesion and conductive properties necessary for battery performance. Lithium-ion batteries comprise a class of materials that are chosen based on various cost and performance tradeoffs. The major materials in lithium batteries that are used commercially today are shown in Table 2.

---

<sup>74</sup>The dynamics of the EV battery end-of-life market, Tutorial on Zoom, Circular Energy Storage, October 22, 2020. <https://batteryrecycling.org.au/tutorial-the-dynamics-of-the-ev-battery-end-of-life-market-2/>.

Table 2. Common materials and their abbreviations used in lithium-ion cells

<b>Cathodes</b>	
Abbreviations	Full name
NMC	Nickel Manganese Cobalt Oxide
NCA	Nickel Cobalt Aluminum Oxide
LNMO	Lithium Nickel Manganese Oxide
LMO	Lithium Manganese Oxide
LCO	Lithium Cobalt Oxide
LFP	Lithium Iron Phosphate
<b>Anodes</b>	
Abbreviations	Full name
Si	Silicon
Gr	Graphite (natural and synthetic)
<b>Electrolyte Solvents/Additives</b>	
Abbreviations	Full name
EC	Ethylene Carbonate
DMC	Dimethyl Carbonate
DEC	Diethyl Carbonate
PC	Propylene Carbonate
FEC	Fluoroethylene Carbonate
<b>Electrode Binders</b>	
Abbreviations	Full name
PVDF	Polyvinylidene Fluoride

Lithium-ion battery components, including anodes, cathodes, electrolytes, and separators, represent a battery supply chain stage where the United States currently relies on foreign imports due to limited domestic manufacturing capacity. Across all components, China leads the world in manufacturing capacity for anodes, cathodes, electrolytes, and separators.<sup>75</sup>

Table 3. Midstream Lithium-ion Battery Manufacturing: Percentage of Total Manufacturing Capacity by Country for Various Component Manufacturing.<sup>76</sup>

	Cathode Manufacturing	Anode Manufacturing	Electrolyte Solution Manufacturing	Separator Manufacturing
United States	--	10%	2%	6%
China	42%	65%	65%	43%
Japan	33%	19%	12%	21%
Korea	15%	6%	4%	28%
Rest of World	10%	--	17%	2%

The U.S.-based cell component manufacturing capacity that does exist is often closely tracked or co-located with downstream manufacturing stages of cell and pack manufacturing, with high concentrations of

<sup>75</sup> BloombergNEF, Battery Components Manufacturing Asset Map 2019, Available for purchase. Accessed March 15, 2021.

<sup>76</sup> BloombergNEF, Battery Components Manufacturing Asset Map 2019, Available for purchase. Accessed March 15, 2021.



production in the Midwest and Southeast regions of the United States.<sup>77</sup> Although co-location offers many benefits, including reduced shipping costs, most foreign-owned EV manufacturers maintain a more global footprint given limited U.S. capacity today. The value of co-location alone is insufficient to overcome scale and coordinated policy and investment support along the full end-to-end battery supply chain.

Further growth of these component market sectors domestically would require the development of new refining capacity to supply stock feeds, domestically-sourced, for component production. Collaboration with countries that produce processed cathode and anode powders, as well as electrolyte precursors, or the establishment of those suppliers in the United States will also be essential for U.S. component production. In addition, domestic development of battery recycling and recovery as well as domestic production of graphite from coal-based secondary sources can offer feedstocks for anode and cathode production. Finally, growth of this component sector can be assisted by increases in the domestic upstream production of processed cathode and anode powders, as well as electrode binder production.

The United States can also leverage leadership in R&D to establish domestic production of future technologies. Many of these technologies require new materials, with very different processing technologies and considerations for scale-up, new manufacturing techniques to build these technologies into cells, and in some cases (such as Lithium metal), new methods to manufacture the cells themselves. This creates the opportunity for the United States to build an intellectual property (IP) base and technical expertise to circumvent the challenges of incumbency in batteries today.

### Cell Production

Battery cells are manufactured as an intermediate good and then sold to end-use industries, which assemble larger battery packs for insertion into EVs, stationary storage systems, and other end uses.

Cells make up over 75 percent of the average cost of an EV battery pack.<sup>78</sup> Lithium-based batteries are made using many cathode materials and a smaller number of anode materials, making the use of substitution a fairly common practice based on end performance, though nearly all current lithium-ion cells use anodes based on graphite. Common cathode materials are shown in Table 4, with the most common being NMC.

Table 4. Typical lithium-ion battery cathode materials.<sup>79</sup>

Short Name	Full Chemical Name	Chemical Composition	EV Manufacturers	Other Uses
LMO	Lithium Manganese Oxide	LiMn <sub>2</sub> O <sub>4</sub>	Nissan, BMW	Power tools, Medical devices, electric powertrains
NMC	Lithium Nickel Manganese Cobalt Oxide	LiNi <sub>x</sub> Mn <sub>y</sub> Co <sub>z</sub> O <sub>2</sub>	GM, Ford, Volkswagen, Toyota, Hyundai	E-bikes, medical devices, other
LFP	Lithium Iron Phosphate	LiFePO <sub>4</sub>	Mostly Chinese based	Electric buses
NCA	Lithium Nickel Cobalt Aluminum Oxide	LiNi <sub>x</sub> Co <sub>y</sub> Al <sub>z</sub> O <sub>2</sub>	Tesla	Tesla stationary applications

<sup>77</sup> BloombergNEF, Battery Components Manufacturing Asset Map 2021, Available for purchase. Accessed March 15, 2021.

<sup>78</sup> Clean Leap, “Battery cell and pack costs and characteristics”. <https://cleanleap.com/7-electricity-transport/71-battery-cell-and-pack-costs-and-characteristics>. Accessed May 4, 2021.

<sup>79</sup> USITC, Office of Industries, ‘Lithium-Ion Battery Materials for Electric Vehicles and their Global Value Chains’, Working Paper ID-068, Published June 2020, Accessed March 15, 2021.

Lithium-ion cell manufacturing is generally located in geographic proximity to demand, though factors such as capacity utilization, supply chain scale and maturity, and proximity to R&D can all impact co-location. The physical weight of lithium-ion battery cells adds transportation costs and complexity, and issues in transport (such as high temperature) could have negative effects on battery performance. Other items, such as the requirement to ship batteries at 30 percent state of charge (SOC), adds additional complexity and increases costs.<sup>80</sup> The hazards associated with lithium-ion cells can be mitigated, and manufacturers factor in these costs of compliance in operations and in the design of their pack assemblies. In 2019, global battery shipments across seven major battery manufacturers exceeded 114 GWh, with passenger EV batteries accounting for most shipments.<sup>81</sup>

Component manufacturing and cell manufacturing are expected to increase in the next 5-10 years as U.S. demand for EVs grows. The benefits of co-location of upstream cell production supply segments remains an open question. A variety of factors impact co-location economics including trade policy, incumbent existing capacity (and overcapacity), transportation costs, policy mandates and incentives, technology maturity, and IP protection policies and practices, as well as environmental policies and enforcement. Current import trends suggest the United States is not harnessing the full potential of co-location. The domestic market has comprised roughly 10 percent of global EV sales since 2017-2019 and the United States has 8 percent of global cell manufacturing capacity, but the United States maintains less than 2 percent share in the cell processed material segments.

Figure 10. Global current and future demand of lithium-ion batteries.<sup>82</sup>

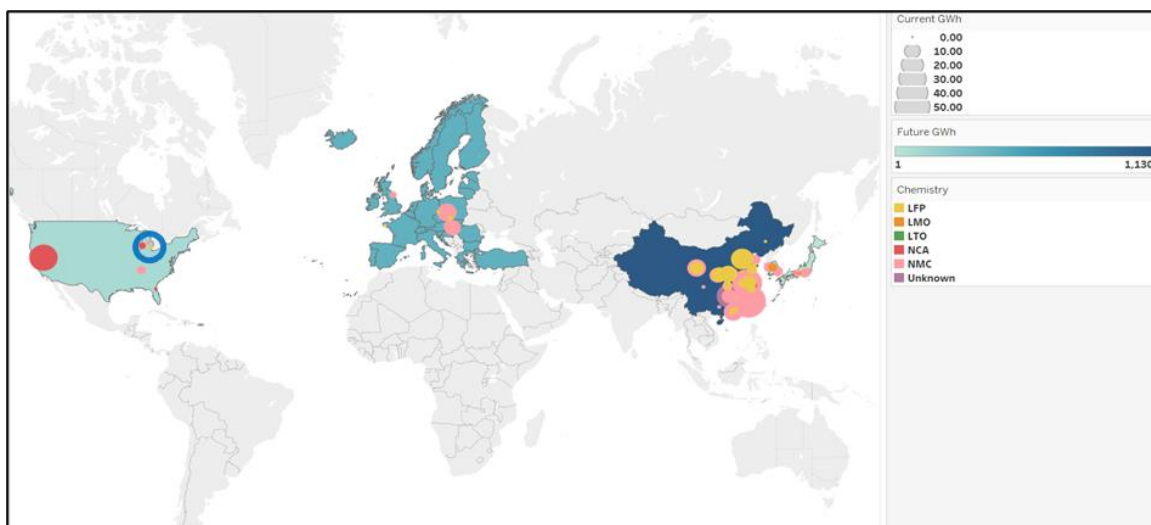

<sup>80</sup> EV Specifications, “2019 Chevrolet Bolt EV – Specifications and Price”.

<https://www.evspecifications.com/en/model/18a190>. Accessed April 11, 2021.

<sup>81</sup> IEA – International Energy Agency. “How global electric car sales defied Covid-19 in 2020”. January 28, 2021.

<https://www.iea.org/commentaries/how-global-electric-car-sales-defied-covid-19-in-2020>. Accessed May 2, 2021.

BloombergNEF, “Company Profiles: 2020 Battery Vendors”, August 13, 2020. Accessed April 16, 2021.

<sup>82</sup> BloombergNEF, “Cell Manufacturing Interactive Database”, April 2020. Available for Purchase. Accessed April 14, 2021.

Figure 11. Annual EV Sales by Region.<sup>83</sup>

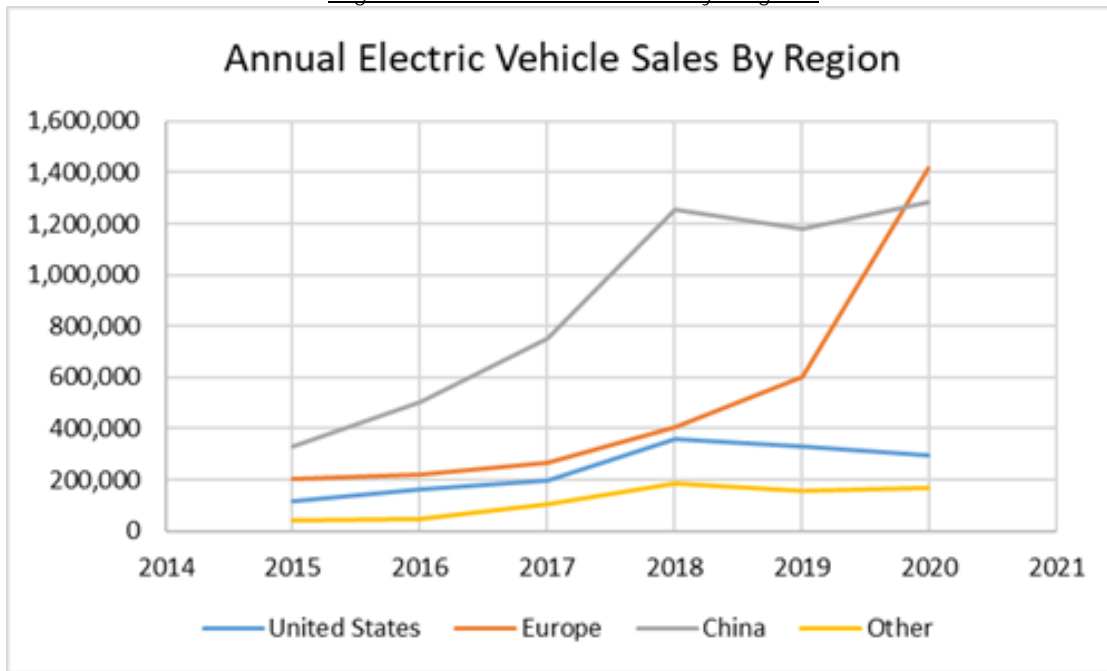

Given the significant cost batteries represent in a completed EV and their criticality to EV programs, vehicle OEMs negotiate with suppliers to secure EV battery supply well before announcing product plans. Therefore, announced domestic EV programs are a strong indication of planned EV battery manufacturing capacity. Tesla's joint venture with Panasonic and General Motors' (GM) joint venture with LG Chem are examples of domestic EV battery manufacturing capacity expanding to meet increased domestic demand. Tesla's leadership has indicated publicly that it is willing to supply EV batteries to other EV OEMs, though the firm has been cell constrained to this point.

There are several battery manufacturers and startups that do not currently have U.S. battery manufacturing capacity but are planning to develop or are rumored to be developing EV battery manufacturing facilities in the United States, including SVOLT Energy Technology, QuantumScape, CATL, Samsung SDI, Fisker, and Rivian. A battery manufacturing plant requires a significant amount of capital expenditure, and without a guaranteed buyer for its product, the investment can be risky. Hence, there is little discretionary supply in the market.

### **Defense-Specific Supply Chain Challenges**

This section defines high-capacity batteries broadly as batteries that are both an enabler of a defense mission and a limiting factor, since those are the relevant batteries that require a secure supply chain to enable the defense mission. For the purposes of defense supply chain risk, the term high-capacity battery is synonymous with advanced battery.

### **Distinctions from Commercial Battery Market**

Defense-specific supply chain risks and opportunities to address these risks differ from the commercial market. To meet its broad mission, DOD is a consumer of a diverse array of both primary and secondary batteries, ranging from high volume commercial commodity cells to low volume custom cells with discrete performance requirements. Weapon system and platform batteries require high reliability, safety, cybersecurity, integrated monitoring, performance/advanced integrated pack design, and design mitigations that do not readily conform to the commercial market. Of the many facets of supply chain risk for DOD batteries, the primary challenge is the frequent DOD requirement for both specialty batteries and

<sup>83</sup> BloombergNEF, "Electric Vehicle Outlook 2019", 2019. Accessed April 14, 2021.

configuration-locked batteries that are not part of larger consumer electronic and EV markets. A secure supply chain divorced from adversarial influence is required to ensure mission resilience.

A broader domestic and allied industrial base, assured material supply, and stronger R&D ecosystem would improve the fragility of the existing defense supply chain. Similarly, the ability of DOD to become a better customer by standardizing batteries across defense applications to achieve larger volume and more consistent purchases would better position DOD to leverage large domestic battery manufacturers.

### **Tariff Impacts on the Competitive Landscape**

The United States imposes a 3.4 percent import tariff on lithium-ion cells<sup>84</sup> and battery packs.<sup>85</sup> Certain minerals needed to produce lithium-ion cells are also subject to tariffs. The general tariff rate for cobalt ores and natural graphite ranges from zero to up to 4.9 percent on artificial graphite.<sup>86,87</sup> Lithium oxide and lithium carbonate face a 3.7 percent general tariff.

Cell imports (HTSUS 8507.90.8000) for use in advanced batteries typically have exceeded imports of battery packs (HTSUS 8507.60.0010), and Japan and Korea have historically been the main suppliers of imported cells. Yet in recent years, there has been a noticeable increase in imports of assembled battery packs. Korea became a significant source of imports of battery packs in 2018 and 2019, though imports of Korean packs have subsequently fallen. In 2020 and the first quarter of 2021, U.S. imports of battery cells and packs from the EU and China both rose significantly. In the last four quarters of data (Q2 2020 through Q1 2021), imports of battery cells and packs reached \$2.7 billion. Over the last four years, imports of battery cells and battery packs for use in EVs have increased at a slightly faster pace than domestic production of EVs. Further analysis is required to fully understand the impacts of tariff structure changes, recent investments from governments, and other policy changes, including how these changes interact with and/or counterbalance the benefits that arise from locating cell manufacturing and pack fabrication near EV demand.

Battery cells and packs that meet the “regional content rules” set out in the USMCA enter the United States tariff-free. As a result of the U.S.-Korea Free Trade Agreement, qualifying Korean battery cells and packs also currently enter into the United States free of any tariffs.

Tariffs can be raised over the U.S. general (or “most favored nation”) tariff rate as a result of certain U.S. trade enforcement actions. The most significant adjustment to the battery tariffs stems from the Section 301 action against China. Battery cells were part of List 1 of the Section 301 tariffs, so imports of cells from China currently face an additional 25 percent tariff on top of the 3.4 percent general tariff, for a total rate of 28.4 percent.<sup>88</sup> Cobalt, nickel, and lithium imported directly from China also currently face an additional 25 percent tariff.<sup>89</sup> Battery packs from China by contrast are on List 4 and now face an additional 7.5 percent tariff.<sup>90</sup>

---

<sup>84</sup> USITC, Harmonized Tariff Schedule (2021 Basic Revision 3). <https://hts.usitc.gov/?query=85079080>.

<sup>85</sup> USITC, Harmonized Tariff Schedule (2021 Basic Revision 3). <https://hts.usitc.gov/?query=850760>.

<sup>86</sup> USITC, Harmonized Tariff Schedule (2021 Basic Revision 3). <https://hts.usitc.gov/?query=2605000000>

<sup>87</sup> USITC, Harmonized Tariff Schedule (2021 Basic Revision 3). <https://hts.usitc.gov/?query=380190>

<sup>88</sup> Cells are imported under Harmonized Tariff Schedule code 8507.90.80, which is included on List 1 at the following: Federal Register, Vol. 83, No. 119, June 20, 2018. <https://ustr.gov/sites/default/files/2018-13248.pdf>.

<sup>89</sup> Federal Register, Vol. 83, No. 137, July 17, 2018. See list 3:

[https://ustr.gov/sites/default/files/enforcement/301Investigations/2018-0026%20China%20FRN%207-10-2018\\_0.pdf](https://ustr.gov/sites/default/files/enforcement/301Investigations/2018-0026%20China%20FRN%207-10-2018_0.pdf)

<sup>90</sup> Batteries are imported under HTS code 8506.60, which is included on List 4 and can be viewed at the following: Federal Register, Vol. 84, No. 161, August 20, 2019.

[https://ustr.gov/sites/default/files/enforcement/301Investigations/Notice\\_of\\_Modification\\_%28List\\_4A\\_and\\_List\\_4B%29.pdf](https://ustr.gov/sites/default/files/enforcement/301Investigations/Notice_of_Modification_%28List_4A_and_List_4B%29.pdf)

## CURRENT RESILIENCE

### Existing manufacturing capacity

Figure 12. Cell manufacturing capacities.<sup>91</sup>

Cell Manufacturing Capacities by Country – Current and Projected

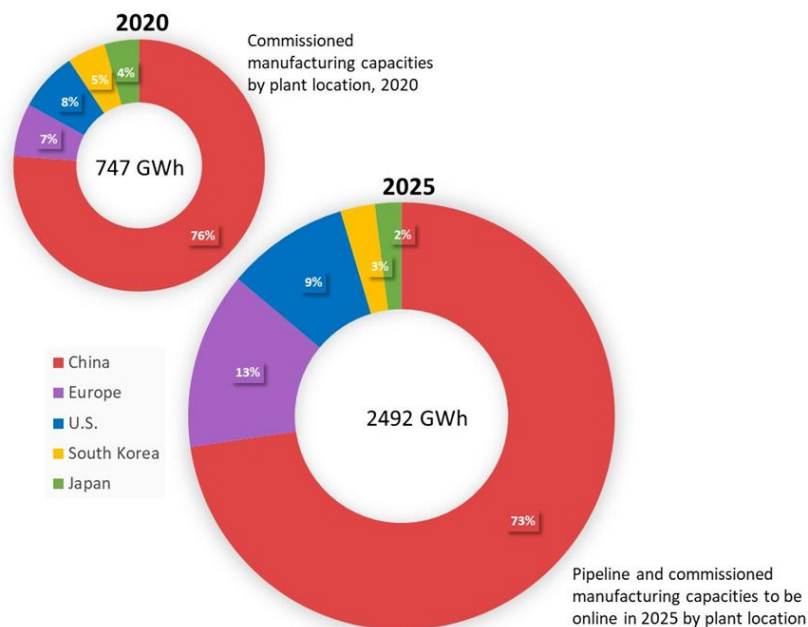

Global cell manufacturing for EVs is anticipated to grow to 2,492 GWh by 2025, with U.S. capacity expected to grow to 224 GWh.<sup>92</sup> However, demand from U.S. annual sales of passenger EVs alone is projected to surpass this anticipated 224 GWh of lithium-ion cell manufacturing capability in 2025. The anticipated increase in stationary storage domestically would also increase demand for lithium-ion batteries. It should also be noted that this domestic battery cell capacity is typically dependent on foreign sources for battery materials and precursors, which risk being affected by future international contracts and policies. As such, this domestic manufacturing capacity must be greatly expanded to develop a more resilient supply chain.

Prior to building U.S. manufacturing facilities, Tesla sourced batteries from Panasonic's facilities in Japan. In July 2014, Tesla announced a plan to build a domestic Gigafactory with Panasonic to lower costs and meet demand for its Model 3.<sup>93</sup> Tesla continues to build additional domestic manufacturing capacity to keep up with demand for EV batteries. In July 2020, Tesla announced that its next U.S. factory will be in Austin, Texas.<sup>94</sup> That factory is currently under construction and will manufacture EV batteries.<sup>95</sup> While Tesla has not officially announced the expected capacity of the factory, BMI estimated that it will have the capacity to

<sup>91</sup> "Lithium-Ion Battery Megafactory Assessment", Benchmark Mineral Intelligence, March 2021. Accessed April 12, 2021. Note: projected capacities vary by source/assessment.

<sup>92</sup> "Lithium-Ion Battery Megafactory Assessment", Benchmark Mineral Intelligence, March 2021. Accessed April 12, 2021.

<sup>93</sup> [https://www.tesla.com/en\\_CA/blog/panasonic-and-tesla-sign-agreement-gigafactory](https://www.tesla.com/en_CA/blog/panasonic-and-tesla-sign-agreement-gigafactory).

<sup>94</sup> The Verge, "Tesla will build Cybertruck factory in Austin, Texas", June 22, 2020.

<https://www.theverge.com/2020/7/22/21334860/tesla-cybertruck-factory-austin-texas-location-model-y>. Accessed April 14, 2021.

<sup>95</sup> Austin American-Statesmen. "Checking in on Tesla's Austin-area factory", November 30, 2020.

<https://www.statesman.com/story/business/technology/2020/11/30/checking-in-on-tesla-s-austin-area-factory/115074054/>. Accessed April 14, 2021.

produce<sup>95</sup> GWh by 2025 and 200 GWh by 2030.<sup>96</sup> Additionally, in September 2020, Tesla announced a 10 GWh manufacturing facility in Fremont, California, where it was already ramping up production.<sup>97</sup>

In September 2019, GM announced that they expect GM to sell one million EVs globally each year.<sup>98</sup> Soon after, in December 2019, GM announced that it entered into a joint venture with LG Chem to produce batteries for upcoming GM EVs.<sup>99</sup> GM also announced in January 2021 that it plans to completely phase out internal combustion engine vehicles by 2035.<sup>100</sup> Less than two months later, GM announced that it is exploring a second battery manufacturing facility with LG Energy Solutions (LGES) which may be built in Tennessee, as well as a \$4.5 billion investment to build out more U.S. capacity.<sup>101,102</sup> In addition, SK Innovation (SKI) has mostly completed its first of two 10 GWh lithium-ion battery cell and pack manufacturing plants in Commerce, Georgia. SKI will produce lithium-ion batteries for Volkswagen Group of America's Modular Electric Drive Matrix line for the North America Region and Ford's EV F-150 program. Overall, this accounts for a net increase of 70GWh by 2025.

### **Location of manufacturing production assets and risks**

In the United States, location of component manufacturing (electrodes, electrolytes, and separators), and cell manufacturing track closely with downstream pack and EV manufacturing, demonstrating producer preference for co-location. Today, U.S. lithium-ion battery component manufacturing is largely concentrated in the Midwest and Southeast regions of the United States. These battery component manufactures are co-located regionally to the Appalachian and Illinois Basins, which could provide significant resources including synthetic graphite needed for component manufacturing from unconventional and secondary sources. EV manufacturers, the majority of which are foreign-owned, tend to keep a global footprint. Cell manufacturing has also largely followed downstream demand centers: for example, Tesla's Gigafactory was built in close proximity to California's large demand. Demand centers have grown in response to policy incentives to promote the adoption of EVs, and to a much lesser extent, stationary battery storage.

---

<sup>96</sup> Tesla "Pilot" Battery Factory = 13th Largest Battery Factory in World | CleanTechnica. September 24, 2020. Accessed May 25, 2021.

<sup>97</sup> Inside EVs, "Tesla Giga Austin To Produce 4680-Type Battery Cells, But When?", November 9, 2020. <https://insideevs.com/news/453374/tesla-giga-austin-4680-battery-cells-when/>. Accessed April 14, 2021.

<sup>98</sup> Car and Driver, "GM CEO Mary Barra Says Company Aims to Sell 1 Million EVs a Year", September 21, 2019. <https://www.caranddriver.com/news/a29153501/mary-barra-gm-sell-million-evs/>. Accessed April 14, 2021.

<sup>99</sup> CNBC, "GM, LG Chem to create \$2.3 billion battery cell venture for electric vehicles, to create 1,100 jobs in Ohio", December 5, 2019. <https://www.cnbc.com/2019/12/05/gm-lg-to-form-2point3-billion-joint-venture-for-battery-cell-production.html>. Accessed April 14, 2021.

<sup>100</sup> NBC News, "GM to go all-electric by 2035, phase out gas and diesel engines", January 28, 2021. <https://www.nbcnews.com/business/autos/gm-go-all-electric-2035-phase-out-gas-diesel-engines-n1256055>. Accessed April 14, 2021.

<sup>101</sup> The Wall Street Journal, "GM Looking to Build Second Battery Factory in U.S.", March 4, 2021. <https://www.wsj.com/articles/gm-looking-to-build-second-battery-factory-in-u-s-11614853806>. Accessed April 14, 2021.

<sup>102</sup> Reuters, GM, LG Energy Solution to build 2nd U.S. battery plant in Tennessee", April 19, 2021. <https://www.reuters.com/technology/gm-lg-energy-solution-build-2nd-us-battery-plant-tennessee-2021-04-16/>. Accessed April 14, 2021.

Figure 13. U.S. Battery Sub-Component Manufacturing by Location and Sub-Component<sup>103</sup>



## RISK ASSESSMENT

### WEAK DOMESTIC PRODUCTION

#### Diminishing Manufacturing Sources and Material Shortages

A robust, secure, domestic industrial base for advanced batteries requires access to a reliable supply of raw, refined, and processed material inputs for lithium batteries. The three most critical battery raw materials identified in the report are lithium, cobalt, and nickel. Other materials include graphite, copper, and manganese. Based on recent estimates, these materials represent around one third of the cost of a finished lithium-ion battery pack.<sup>104</sup> Among the critical materials, lithium, cobalt, and graphite face supply constraints. With regard to nickel, according to the USGS, there are ample reserves both globally and in the United States, however refining capacity may lead to supply constraints. Sustainable domestic extraction from economically viable primary and secondary sources, increased recycling capacity, coordination with allies and trading partners, and R&D to identify earth abundant substitutes can all help prevent critical material shortages. In concert with these levers to increase critical material supply, investments and other policy support for domestic refining, processing, and manufacturing can help prevent gaps or bottlenecks in the supply chain that can create shortages and other supply risks.

#### Limited domestic support

Without sufficient domestic EV demand, it remains economically challenging for U.S.-based industrial infrastructure to thrive. Since EVs account for between 80-85 percent of the lithium-ion cell battery use, demand for EVs, more than other industries that rely on lithium-ion cells, is driving decisions about where to locate battery system manufacturing, along with the corresponding supply chain. Until 2020, China was the largest global EV market and therefore dominated the supply chain for the manufacture of lithium-ion batteries. As China ramps up production capacity, Chinese firms may be gaining competitive first-mover pricing advantage from economies of scale, process learning, and control of critical inputs. China relies on massive incentives to support domestic EV manufacturing, such as retail-level subsidies to create demand for domestic products, and initially a battery certification program implemented in a manner that limited market

<sup>103</sup> BloombergNEF, Battery Components Manufacturing Asset Map, April 2020. Available for purchase. Accessed March 15, 2021. Includes all plants announced and fully commissioned.

<sup>104</sup> SP Global, "Why Lithium has Turned from Gold to Dust for Investors" September 9, 2019. <https://www.spglobal.com/en/research-insights/articles/why-lithium-has-turned-from-gold-to-dust-for-investors>. Accessed April 14, 2021.

access for certain foreign products. China also leads in the processing of minerals and raw materials required in lithium-ion battery manufacturing.

Europe and India are developing policy initiatives (mainly mandates and incentives) and programs to counter China's leading position in lithium-ion battery production and to localize supply chains within their own regions. Further, governments and companies are investing in new battery chemistries to reduce costs, limit the use of sensitive raw material inputs, increase energy densities, and meet other needs.

### **Transitioning and building a skilled workforce**

A skilled workforce will be needed for extraction, processing, purification, and recycling, as well as researching, developing, designing, manufacturing, and deploying advanced batteries in a variety of applications, including EVs, stationary, consumer electronics, industrial, and defense. Education and training will be needed across the battery ecosystem including skilled trades (e.g., machinists, welders, technicians, operators, designers), engineers, analysts, and researchers.

The United States has a skilled workforce in the auto industry that could support the manufacture of batteries, along with EVs. The automotive industry employs approximately two million people. Shoring up the high-capacity battery supply chain provides opportunities to employ high-skilled autoworkers facing disruption in the shift to EVs, but a smooth transition is not assured without appropriate planning and support. First, firms may fail to tap into the existing skill base. While internal combustion engine and EV vehicles require similar amounts of labor to produce according to some analyses, their content differs substantially. However, as automakers and their suppliers retool existing facilities to produce EVs and batteries, there is also an opportunity to implement programs and production processes that retrain the existing skilled workforce. Policy support can also help address these issues, for example by incentivizing reemployment of current powertrain workers in making EV propulsion systems at similar wages (with retraining as necessary) and supporting employee rights to union representation. As the domestic supply chain is developed and workers are trained, attention is needed to ensure equitable development of workforce opportunities, including for people of color and others who have been historically underserved, marginalized, and adversely affected by persistent poverty and inequality.

Additionally, wages in the new battery industry jobs so far have been below those in the powertrain plants they will replace over time. In the third quarter of 2020, employees employed in gasoline engine and parts manufacturing and powertrain components manufacturing for motor vehicles earned \$1,225 per week on average, including any overtime, while production workers likely make closer to \$925 per week. About 19 percent of motor vehicle manufacturing workers are members of labor unions. Top-scale unionized workers earn more than \$31 per hour in base pay. In contrast, the automotive battery plants that are in existence or are advertising for production workers pay much less than existing powertrain plants, in the range of \$17-21 per hour. In addition, some existing or announced EV plants are non-union. To support a sustainable industry with a skilled and resilient workforce, OEMs should leverage and support existing auto industry employees working in parts of the industry value chain that will see a transition in the coming years. This includes through access to training and retraining support and the opportunity to unionize and collectively bargain.

## **FOREIGN DEPENDENCE**

### **Dependence on single source nation**

Global production for lithium, cobalt, and graphite are primarily dependent on a single nation. Figure 14 shows that for each of these materials, a single country controls over 60 percent of the global production.



Figure 13. Top four producers of highest risk battery materials for mining and refining stages.<sup>105</sup>

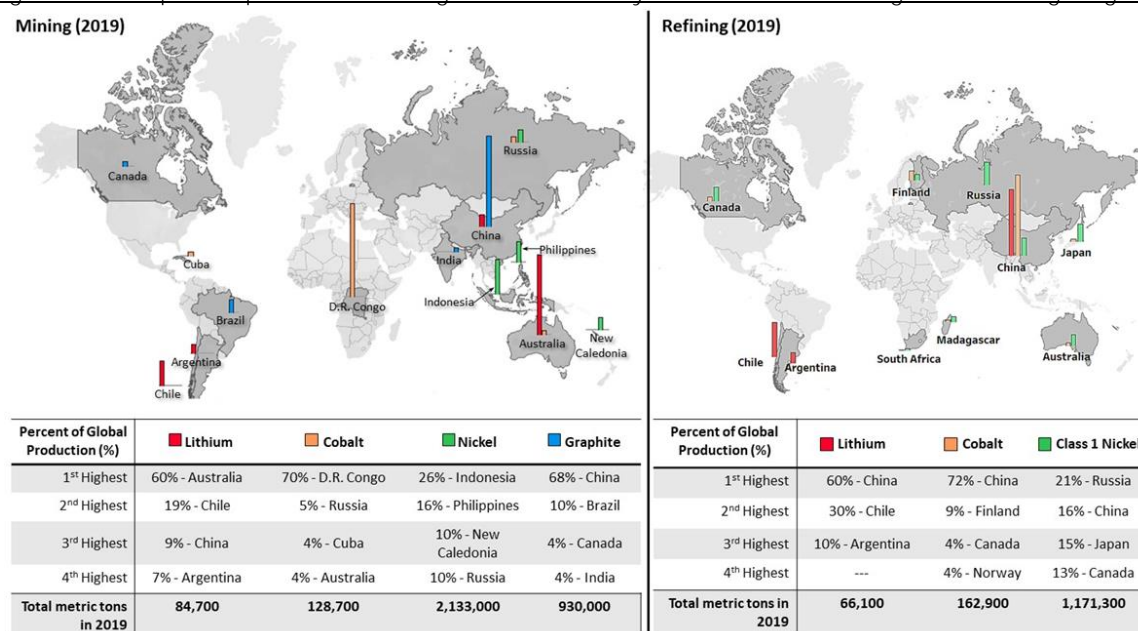

### Dependence on potential adversaries

The Chinese government's firm economic control permits it to develop battery critical materials infrastructure well-ahead of market drivers. In the last two years alone, Chinese companies have invested heavily in this area.<sup>106</sup> U.S. cell makers have expressed to DOE their surprise at material prices from Chinese suppliers that are below normal market prices. The combination of multiple "below cost" products on the market and massive Chinese government subsidies raises trade questions.

There is also widespread evidence that China is operating well outside of globally accepted practices for international commerce. According to one estimate, much of the \$100 billion in Chinese direct government subsidies were or are available solely to Chinese-based firms or Chinese-based production.<sup>107</sup> These subsidies were also initially withheld from firms utilizing cells from foreign-based firms through opaque certification requirements. Those certification requirements also appear aimed at extracting IP on cell composition and construction from foreign-based suppliers. China has used its state-supported position as the leading manufacturer and consumer of lithium-ion cells to further limit competition in the supply chain for those cells. China's approach largely consists of granting preferential access to its domestic, largely state-run firms, making precompetitive investments in refinement capacity for materials and commodities markets, subsidizing this capacity until demand is created, and, at times, dumping products and materials onto the international market. China has used this market control to restrict access to materials and to inhibit the ability of firms operating outside of China to compete. Chinese firms have also made multiple and large investments in mining operations around the world to ensure their supply of critical materials like cobalt, nickel, and lithium.

<sup>105</sup> (Mining) NREL Analysis. USGS Mineral Commodity Summaries 2019.

<https://www.usgs.gov/centers/nmic/mineral-commodity-summaries>. (Refining) NREL Analysis and BloombergNEF Battery Metals Database, accessed March 7, 2021.

<sup>106</sup> The Northern Miner. "The West needs to level the playing field to compete with China". April 23, 2021. <https://www.northernminer.com/op-ed/1003830378/1003830378/>. Accessed April 27, 2021.

<sup>107</sup> CSIS, "China's Expensive Gamble on New-Energy Vehicles", Information found on pages 9-10. November 6, 2018. <https://www.csis.org/analysis/chinas-risky-drive-new-energy-vehicles>. Accessed May 3, 2021.

## **Risks most likely to strain, disrupt, compromise, or eliminate the supply**

### *Geopolitical: Export restrictions, environmental, and human rights concerns*

There are several geopolitical disruptions that could interrupt the high-capacity battery supply chain. The first is the possibility of China restricting exports of cobalt, nickel, lithium, graphite, or finished anode or cathode materials, for each of which China has dominant processing capacity. China has shown a willingness to restrict access to resources, with reductions in its exports of rare earth elements over the past ten years. Thus, it is reasonable to expect that China could restrict exports of any or all of the battery supply chain materials it produces, due to trade tensions with the United States or a simple prioritization of domestic customers for its battery materials. Alternatively, China could dump processed materials or finished anode and cathode materials on global markets to reduce competition.

A related concern is the possibility of substandard or less advanced material being sold to U.S. cell makers by foreign suppliers. This has been an intermittent issue with small domestic cell makers recently as China has shifted much of its cathode production to high nickel NMC. U.S. companies have indicated that they were supplied “previous generation” material as China’s cathode producers reserve their most recent, and best, material for their larger volume Chinese cell making clients.

Finally, human rights violations, including forced labor, and corruption are a concern in both the DRC (where over 50 percent of the world’s cobalt is mined) and in China (where egregious human rights violations including genocide and other mistreatment of minorities and non-favored political factions continues.) Human rights violators should not be allowed to profit by accessing the U.S. market or other markets that uphold respect for human rights. Companies or financial institutions should increase supply chain due diligence to identify and, as relevant, mitigate risks to links to human rights violations or corruption which could impact supply chains. Additionally, public opinion could turn sharply against any material imports associated with human rights violations or corruption, requiring U.S. manufacturers to identify other sources for input materials.

To ensure that materials used in U.S. products employ practices that are in line with U.S. values, including environmental protection, human rights, and environmental justice at home and abroad, the U.S. can participate in developing standards. For example, the U.S. Government participates in the International Organization for Standardization Technical Committee (ISO/TC) 333<sup>108</sup> on lithium and is engaged in efforts to improve sustainability (environmental, economic, and social) in global critical material supply chains.

### *Market/Economic shocks*

The world has experienced several market or economic shocks over the past decades such as the oil price spike in the late 2000s. Smaller “irrational” price spikes have impacted the battery supply chain over the past several years, specifically for materials like cobalt, nickel, and lithium carbonate. It seems reasonable to anticipate future spikes in prices as demand increases and supply might, at least temporarily, struggle to catch up. Lithium, in particular, is currently susceptible to temporary supply shortfalls as the brine evaporation method of producing lithium can take several years to significantly expand.

A second market related disruption could emerge from a tax or penalty on products whose production and delivery entail large CO<sub>2</sub> emissions. If such a policy were to become widespread, prices of Chinese exports to all customers, including in countries not imposing such penalties, could be severely impacted. For example, EV battery materials made in China and shipped to the United States or Europe would have high CO<sub>2</sub> emissions because China uses coal as a primary electricity source, which emits more CO<sub>2</sub> per MWh of energy

---

<sup>108</sup> ISO, “ISO/TC 333, Lithium”. <https://www.iso.org/committee/8031128.html>. Accessed April 14, 2021.

than the fuel mix in the United States and Europe, and the materials must be shipped over 7,000 miles to the United States, Europe, or other markets set to grow in the future.

### *Natural disaster/Climate shocks*

Further study is required to assess the global climate vulnerabilities of the advanced battery supply chain. From sea level rise to extreme heat to more frequent and severe extreme weather events, there is significant potential for parts of the supply chain to be exposed to this risk. Additionally, policies that promote climate risk assessment and disclosure from actors along the supply chain (and for all supply chains) can increase awareness of the exposure to climate shocks and prompt appropriate investment in resilience and adaptation strategies.

Supply chain disruptions can be caused by a number of factors, including natural disasters and pandemics. One example of such disrupting factors is the COVID-19 pandemic, which is likely to have a prolonged effect on many markets and manufacturing sectors. China's dominance in the lithium-ion battery manufacturing supply chain led to significant worldwide effects during the onset of the COVID-19 pandemic, with complete shutdowns during the first few months of the COVID-19 pandemic leading to a halt of many manufacturing plants, including those held by CATL and BYD.<sup>109</sup> During the pandemic, North American lithium-ion battery manufacturers implemented plans to limit impacts on their supply chains from products coming out of China amid widespread shutdowns. These changes led to temporary production shifts from China to Japan and South Korea for some inputs.<sup>110</sup> In addition to manufacturing, COVID-19 had a significant effect on upstream minerals production and availability.<sup>111</sup>

The COVID-19 pandemic's rippling effects on critical minerals and the lithium-ion battery supply chains highlight the risks of non-diversified market streams. Risk mitigation strategies and a renewed focus by the United States on diversifying and securing the supply chains for lithium-ion batteries are critical for widespread clean energy development domestically. Focusing on increasing sources for critical minerals and ramping up North American manufacturing could result in fewer disruptions during future worldwide crises.

## **GLOBAL FOOTPRINT**

China, India, and the EU have all outlined high-level plans to incentivize domestic advanced battery manufacturing and demand. Similarly, Australia and Finland are seeking opportunities to develop their battery industries and leverage their domestic natural resources. In contrast, the United States lacks a comprehensive strategy to incentivize investment in the industry. Some U.S. states have discrete policies to incentivize demand for EVs and/or stationary storage and policies aimed at improving the general business climate, but policies do not exist that target the end-to-end advanced battery industry in a coordinated way that can support U.S. leadership in the advanced battery supply chain like many other global players have.

### **AUSTRALIA**

Despite significant natural resource endowments of battery-related materials, Australia has not yet developed a broader ecosystem for advanced batteries. Australian state governments have introduced incentives to support the development of local battery industries, but the Australian Government has not yet developed a comprehensive national strategy to develop a domestic battery industry.

Australia has an abundance of key commodities needed to produce advanced batteries, such as lithium, nickel, vanadium, graphite, manganese, and alumina. These commodities require processing, however, before

---

<sup>109</sup> Dyatkin, B., Meng, Y.S. COVID-19 disrupts battery materials and manufacture supply chains, but outlook remains strong. *MRS Bulletin* 45, 700–702 (2020). <https://doi.org/10.1557/mrs.2020.239>

<sup>110</sup> Dyatkin, B., Meng, Y.S. COVID-19 disrupts battery materials and manufacture supply chains, but outlook remains strong. *MRS Bulletin* 45, 700–702 (2020). <https://doi.org/10.1557/mrs.2020.239>

<sup>111</sup> IEA – International Energy Agency. “Clean energy progress after the Covid-19 crisis will need reliable supplies of critical minerals”. May 6, 2020. [iea.org/articles/clean-energy-progress-after-the-covid-19-crisis-will-need-reliable-supplies-of-critical-minerals](https://www.iea.org/articles/clean-energy-progress-after-the-covid-19-crisis-will-need-reliable-supplies-of-critical-minerals). Accessed May 3, 2021.

becoming battery materials.<sup>112</sup> Australia currently has no commercial production of Class 1 chemicals or battery precursors. Australia also has no cell manufacturing, but it does have an active battery pack assembly industry. Australia only recycles two percent of its lithium-ion batteries, and its recycling processes typically disassemble and homogenize materials for export to places like Korea, which have developed battery recycling capabilities.

Australia currently lacks battery-specific initiatives at the national level. A recent report noted that the 59 major policies, grants, and programs applicable to battery industries are also applicable to broader industries, including mining or manufacturing.<sup>113</sup> Several Australian state governments include policies to support increased demand for batteries in their state-level energy policies, however, primarily in Western Australia.

The United States counts Australia as one of its partners in the Energy Resource Governance Initiative (ERGI). There are already science and technology level engagements with Australia as well as shared best practices in the mining sector.

## CHINA

China maintains a significant position in the global supply chain for advanced batteries from refining all the way through downstream battery cell manufacturing, despite producing only 23 percent of global supply for battery raw materials according to Benchmark Minerals Intelligence (Figure 15).

Figure 14. China's share of battery production in full year, 2019.<sup>114</sup>

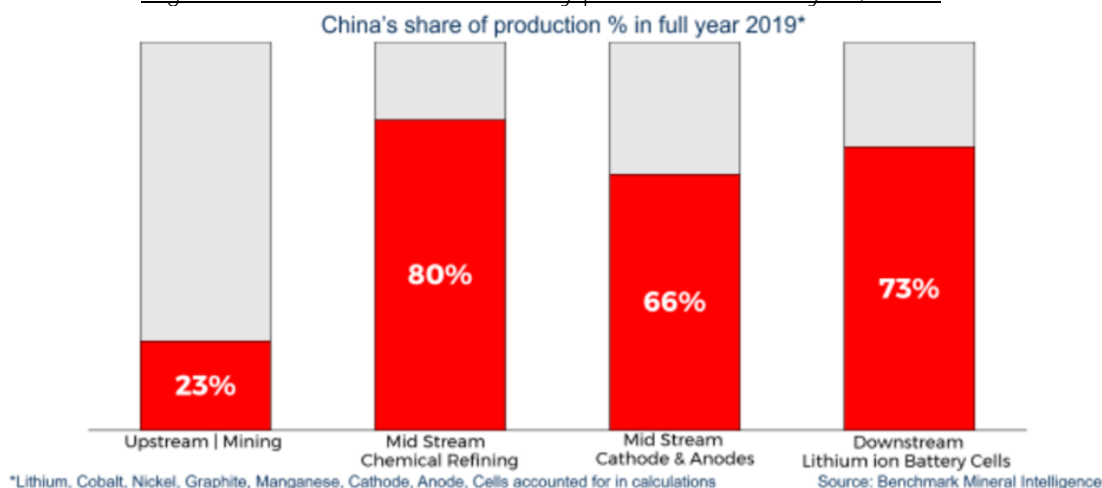

China's dominance in the battery industry is focused on mid-stream and downstream production. Chinese chemical production of Class 1 raw materials stood at 80 percent of total global output in 2019.<sup>115</sup> China is the world's major processor of lithium carbonate into lithium hydroxide, cobalt into cobalt sulphate, manganese refining, and uncoated spherical graphite refining. China's ownership of the chemical conversions

<sup>112</sup> Argus Media, "Australia's downstream lithium sector takes shape" February 24, 2021.

<https://www.argusmedia.com/en/news/2189935-australias-downstream-lithium-sector-takes-shape>

<sup>113</sup> Australian Government – Department of Industry, Science, Energy, and Resources, "State of Play, Australia's Battery Industries". Produced for the Future Battery Industries CRC. [https://fbicrc.com.au/wp-content/uploads/2020/10/20-00191\\_MR\\_REPORT\\_FBICRC-StateOfPlayBattery\\_WEB\\_201002.pdf](https://fbicrc.com.au/wp-content/uploads/2020/10/20-00191_MR_REPORT_FBICRC-StateOfPlayBattery_WEB_201002.pdf). Accessed May 3, 2021.

<sup>114</sup> Mining.com, "China's grip on battery metals supply chain". May 7, 2020. <https://www.mining.com/chart-chinas-grip-on-battery-metals-supply-chain>. Accessed May 3, 2021.

<sup>115</sup> Benchmark Minerals Intelligence, "China Controls Sway of Electric Vehicle Power Through Battery Chemicals, Cathode and Anode Production". May 6, 2020. <https://www.benchmarkminerals.com/membership/china-controls-sway-of-electric-vehicle-power-through-battery-chemicals-cathode-and-anode-production/>. Accessed May 3, 2021.

needed to produce batteries has ensured that the global supply of battery raw materials flows to China for value-added production.

China has identified what it refers to as new energy vehicles (NEV), largely synonymous with EVs, and electrical grid equipment (e.g., electricity grid storage systems) as "critical industries" in its industrial plans, including "Made in China 2025" and "Strategic Emerging Industries". According to Made in China 2025, NEVs and electrical grid equipment are priorities to develop locally or purchase relevant technologies from abroad. In pursuit of this goal, China has created a range of policies to assist Chinese vehicle enterprises and energy companies to develop or acquire technologies and localize manufacturing in China.<sup>116</sup> These include a battery certification program that has been used to bar or hinder advanced batteries produced by foreign-owned firms from participating in its EV market or benefitting from various incentives. While China has high production levels of lithium-ion battery cells, a substantial proportion of the production to date has been lower quality, although the quality is improving over time.<sup>117</sup>

Beginning in 2010, China's central government provided EV manufacturers with a retail level subsidy of up to \$8,700 to reduce the purchase price to consumers. These subsidies were set to expire in 2020 but were extended to the end of 2022, though they will be gradually reduced. Some sub-central governments also offered additional subsidies. Electric buses received subsidies of up to \$87,000 and frequently benefitted from local subsidies. Eligibility for these subsidies was limited to vehicles included in a catalogue of approved vehicles maintained by the Ministry of Industry and Information Technology (MIIT). Initially, mostly vehicles made in China were included in this catalogue; imported vehicles did not receive the subsidy.<sup>118</sup> Some Chinese cities also waive sales and usage taxes and exempt vehicles included in MIIT's catalogue from city license plate lotteries, meaning they can be purchased and registered by consumers without long delays.<sup>119</sup>

120, 121, 122

From 2015 to 2018, China introduced a series of measures that linked these subsidies to the use of domestically-made battery cells and required a transition to production in-country by vehicle manufacturers operating in the Chinese market.<sup>123</sup> This resulted in significant loss of business for U.S. and other non-Chinese cell manufacturers and factored into future manufacturing plant decisions by multinational firms.<sup>124</sup>

125

---

<sup>116</sup> CSIS, "China's Expensive Gamble on New-Energy Vehicles", November 6, 2018.

<https://www.csis.org/analysis/chinas-risky-drive-new-energy-vehicles>. Accessed May 3, 2021.

<sup>117</sup> Benchmark Minerals defines production quality capabilities based on a three-tiered system. Production in the United States, the EU, Japan, and Korea occurs from tier one suppliers who can supply global manufacturers. About a third of China's production is considered tier two which can only support cars sold in China. Another third (tier three) quality is too low support automotive use. Tesla selection of CATL as the battery manufacturer to provide cells for one of its vehicle variants made in China demonstrates the growing capability of Chinese cell suppliers.

<sup>118</sup> CSIS, "China's Expensive Gamble on New-Energy Vehicles", November 6, 2018. Information found on pages 9-10 of report. <https://www.csis.org/analysis/chinas-risky-drive-new-energy-vehicles>. Accessed May 3, 2021.

<sup>119</sup> The policies vary by city. For instance, Beijing still has a quota for NEVs, but it is separate and larger than the quota for combustion vehicles.

<sup>120</sup> Gasgoo, China Automotive News. "China announces purchase tax exemption for NEVs bought from 2021 to 2022", April 22, 2020. [http://autonews.gasgoo.com/new\\_energy/70017077.html](http://autonews.gasgoo.com/new_energy/70017077.html). Accessed April 14, 2021.

<sup>121</sup> Electrive, "China to remove quotas on licence plates for NEVs", June 9, 2019.

<https://www.electrive.com/2019/06/09/china-to-lift-quotas-on-nev-licence-plates/>, Accessed April 14, 2021.

<sup>122</sup> Global Times, "Beijing to release new license plate lottery policy", June 1, 2020.

<https://www.globaltimes.cn/content/1190224.shtml#:~:text=The%20government%20of%20Beijing%20on,acceptance%20rate%20for%20the%20households>. Accessed April 14, 2021.

<sup>123</sup> CSIS, "China's Expensive Gamble on New-Energy Vehicles", November 6, 2018.

<https://www.csis.org/analysis/chinas-risky-drive-new-energy-vehicles>. Accessed May 3, 2021.

<sup>124</sup> CSIS, "China's Expensive Gamble on New-Energy Vehicles", November 6, 2018. Information found on pages 9-10 of report. <https://www.csis.org/analysis/chinas-risky-drive-new-energy-vehicles>. Accessed May 3, 2021.

<sup>125</sup> For example, Tesla has recently started manufacturing operations in China. In addition to Tesla Model 3 sales from the new Shanghai facility, which opened days before the end of 2019, Tesla estimates that its' Model Y will also begin production in the 4th quarter of 2020. As a result, the locally produced Model 3s no longer face Chinese

Recent policy goals aim for EVs to constitute at least 25 percent of the Chinese market in by 2025.<sup>126</sup> In the area of electric buses, China dwarfs the rest of the world for many reasons, including generous government subsidies and regulatory incentives for both producers and end-users. In 2018, China's electric bus fleet comprised 421,000 out of a total global fleet of 425,000. By comparison, the U.S. electric bus fleet in 2018 totaled 300 vehicles.<sup>127</sup> Enabled by subsidies, Chinese-based bus manufacturer BYD dominates the global market.<sup>128</sup> BYD has opened facilities around the globe, including in the United States, where it is competing with less established market competitors for electric bus sales.<sup>129, 130</sup>

China has for several years dominated the global EV market. After major reductions in the previously-mentioned consumer subsidies at the beginning of July, Chinese sales declined slightly in 2019 to 1.1 million vehicles.<sup>131,132,133</sup> By 2019, the global EV market had swelled to 2.1 million units annually, with over 50 percent of sales in China.<sup>134</sup> COVID-19 negatively affected many vehicle markets around the world in 2020. Yet, despite a 4 percent fall in total Chinese vehicle sales for the year, Chinese 2020 EV sales rose roughly 12 percent to 1.2 million vehicles. But due to growth in European EV sales, Chinese demand accounted for a lower percentage of 2020 global EV sales than in 2019 at around 39 percent.<sup>135,136,137</sup>

---

import tariffs and are eligible for Chinese subsidies. The Model Y will enjoy the same benefits, which will likely result in significantly higher sales given the competitiveness of the Model 3 in the Chinese market at its previously higher price points.

<sup>126</sup> Reuters, “China wants new energy vehicle sales in 2025 to be 25% of all car sales”, December 2, 2019. <https://www.reuters.com/article/us-china-autos-electric/china-wants-new-energy-vehicle-sales-in-2025-to-be-25-of-all-car-sales-idUSKBN1Y70BN>. Accessed May 3, 2021.

<sup>127</sup> Bloomberg, “The U.S. Has a Fleet of 300 Electric Buses. China Has 421,000”, May 15, 2019. <https://www.bloomberg.com/news/articles/2019-05-15/in-shift-to-electric-bus-it-s-china-ahead-of-u-s-421-000-to-300>. Accessed May 3, 2021.

<sup>128</sup> Fortune, “13 years after investing in an obscure Chinese automaker, Warren Buffett’s BYD bet is paying off big”, March 2, 2021. Investors in BYD are global. For example, Berkshire Hathaway Inc. purchased is now equivalent to approximately 25 percent of the stock in 2008.

<https://fortune.com/2021/03/02/warren-buffett-investments-berkshire-hathaway-byd/>. Accessed May 25, 2021.

<sup>129</sup> BYD has electric bus manufacturing sites in California, France, Hungary, and a JV in the United Kingdom. CV News, “BYD Opens New Electric Bus Facility in Hungary”, April 5, 2017. BYD opens new electric bus facility in Hungary – CV news. Accessed May 25, 2021.

BYD North America Company Profile | Recycling Product News. Accessed May 25, 2021.

BYD Europe. Accessed May 25, 2021.

<sup>130</sup> Think Progress, “The bus wars are over. Electricity — and China — won”, May 24, 2019.

<https://thinkprogress.org/electric-buses-outsell-diesel-china/>. Accessed March 31, 2021.

<sup>131</sup> International Council on Clean Transportation. Policy Update, “China Announced 2019 Subsidies for new Vehicles”, 2019. [https://theicct.org/sites/default/files/publications/ICCT\\_China\\_Nev\\_Subsidy\\_20190618.pdf](https://theicct.org/sites/default/files/publications/ICCT_China_Nev_Subsidy_20190618.pdf) Accessed March 31, 2021.

<sup>132</sup> BloombergNEF, Electric Vehicle Outlook 2020, Interactive Dataset, April 2020. Available for purchase. Accessed March 31, 2021.

<sup>133</sup> EV purchase subsidies were cut by approximately 50 percent on June 26, 2019. In addition, vehicles with ranges below 250 kilometers (155 miles) per charge no longer qualify. The reduction in subsidies led to a substantial slowdown in Chinese EV sales beginning in August. EV sales appeared to stabilize and return to growth by December 2019.

<sup>134</sup> Global EV Outlook 2020. Technology report, June 2020. <https://www.iea.org/reports/global-ev-outlook-2020>. Accessed April 27, 2021.

<sup>135</sup> EV Volumes, “Global Plug-in Vehicle Sales Reached over 3,2 Million in 2020”, data found in figure titled “BEV+PHEV Sales and % Growth”, <https://www.ev-volumes.com/> Accessed March 31, 2021.

<sup>136</sup> BloombergNEF, Electric Vehicle Outlook 2020, Interactive Dataset, April 2020. Available for purchase. Accessed March 31, 2021.

<sup>137</sup> Bloomberg, “Buyers Snapping Up New Cars, Even If They’re the Wrong Color”, March 31, 2021.

<https://www.bloomberg.com/news/articles/2021-03-31/buyers-are-snapping-up-new-cars-even-if-they-re-the-wrong-color>. Accessed April 24, 2021.

## EUROPE

The EU has prioritized battery supply chains under the European Commission's industrial policy through the European Battery Alliance, which launched in 2017. According to the Alliance: "The immediate objective is to create a competitive manufacturing value chain in Europe with sustainable battery cells at its core. To prevent a technological dependence on our competitors and capitalize on the job, growth and investment potential of batteries, Europe has to move fast in the global race."<sup>138</sup> The alliance created a strategic plan for realizing these goals that seeks to secure battery manufacturing and access to critical materials across the entire supply chain.

In December 2019, the EU stated the battery sector was of "strategic interest" and announced a \$3.5 billion fund to promote R&D of batteries to increase European global competitiveness. The fund is slated to be completed by 2031 and an initial \$3.5 billion was provided by seven countries: Belgium, Finland, France, Germany, Italy, Poland, and Sweden. The EU is anticipating this fund will catalyze approximately \$5.5 billion in private sector investment in the region, while leveraging 17 direct participants including BASF, BMW, Opel, and Varta.

The impacts of COVID were also felt in the European auto market. Overall, 2020 European vehicle sales were down roughly 20 percent for the year.<sup>139, 140</sup> However, plug-in vehicle sales were up 137 percent in 2020 over 2019 sales. EV sales also hit record highs as a portion of sales at over 10 percent of total LDV sales. The European market thus overtook China for total EV sales with 1.3 million units sold in 2020.

Increased sales are the result of a number of policy measures incentivizing EV sales that are administered at the both the EU and member-state level.<sup>141</sup> The most impactful European policy measure for stimulating market demand and attracting manufacturing in the region began this year, when regulations requiring 95 percent of an automaker's fleet to emit no more than 95 grams of carbon dioxide per kilometer took effect.<sup>142, 143</sup> Steep non-compliance fines are driving automakers to speed up the electrification of their lineups by offering more gasoline-electric hybrids and cars powered by batteries.<sup>144, 145</sup> New models will be produced

---

<sup>138</sup> European Commission, European Battery Alliance, "Annex to the Communication from the Commission to the European Parliament, the Council, the European Economic and Social Committee and the Committee of the Regions", Brussels, 17.5.2018 COM(2018) 293 final ANNEX 2, Page 2. [https://ec.europa.eu/transport/sites/transport/files/3rd-mobility-pack/com20180293-annex2\\_en.pdf](https://ec.europa.eu/transport/sites/transport/files/3rd-mobility-pack/com20180293-annex2_en.pdf). Accessed April 27, 2021.

<sup>139</sup> EV Sales Blogpost. "Q1-Q3 2020 Sales by OEM", October 30, 2020. <http://ev-sales.blogspot.com/2020/10/>. Accessed April 27, 2021.

<sup>140</sup> BloombergNEF, "1<sup>st</sup> Quarter 2021 Electrified Transport Market Outlook", March 9, 2021. Accessed April 27, 2021.

<sup>141</sup> For example, EVs are exempt from purchase taxes including a 25 percent value added tax on purchases in Norway. As a result, Norway leads the world in EV sales as a percentage of passenger vehicle sales with over 50 percent of new vehicle sales being EVs. In the Netherlands, EVs have no road tax for 5 years, are exempt from the luxury car tax which can range from a few hundred to over €10,000 (approximately \$11,170) and face significantly lower income tax on company cars provided for private use. In the UK, tax changes for company cars resulted in EV sales to be up a 145 percent with a market share of nearly six percent. In France, EV sales were up 400 percent in January 2020 with an 11 percent market share. Although these rates are unlikely to be sustained in France, it does signal strong growth.

<sup>142</sup> Bloomberg, "Europe's Tough Emissions Rules Come With \$39 Billion Threat", June 26, 2019. <https://www.bloomberg.com/news/articles/2019-06-26/europe-s-tough-new-emissions-rules-come-with-39-billion-threat>. Accessed April 27, 2021.

<sup>143</sup> This policy is further phased, so that in 2021, the whole fleet must achieve the same level. Automakers can average fleet emissions and mitigate penalties during a phase-in period. Cars that emit less than 50 grams of CO<sub>2</sub> per kilometer will count for two cars in 2020.

<sup>144</sup> Approximately \$106 per gram CO<sub>2</sub> for each car over the target.

<sup>145</sup> Estimates suggest that the availability of plug-in models will increase by around 40 percent.

in high volumes, including vehicles such as Volkswagen's ID 3 and ID 4. Most of these new models have improved capabilities, such as faster charging or longer range, or lower costs.<sup>146, 147</sup>

## FINLAND

Like Australia, Finland possesses significant natural resources of battery-related materials, such as nickel, cobalt, and lithium. Beyond resource endowments, Finland has refining capacity for nickel, cobalt, and copper.<sup>148</sup> In contrast to Australia, Finland has access to a much larger market for battery-related products, due to Finland's proximity to the European market and its status as an EU member-state. Finland is seeking to position itself as a key supplier in the European battery value chain. On January 26, 2021, Finland's Ministry of Economic Affairs and Employment released its National Battery Strategy 2021.<sup>149</sup>

Finland seeks to leverage its experience in mining and refining its mineral reserves to position itself as a sustainable supplier to Europe. Finland's national strategy prioritizes several focus areas: (1) production of battery materials; (2) advanced battery materials; (3) battery and production technologies; and (4) solutions.

## INDIA

India aspires to serve as a global leader in the deployment and manufacturing of battery energy storage systems.<sup>150</sup> On November 11, 2020, the Government of India (GOI) approved a Production-Linked Incentives (PLI) program of approximately \$27 billion over five years for ten key sectors, which is intended to encourage domestic manufacturing, reduce imports, and generate employment.<sup>151</sup> The program provides nearly \$2.5 billion in incentives for Advance Chemistry Cell (ACC) battery manufacturing to encourage large domestic and international players to establish competitive ACC battery infrastructure in the country. This area represents one of the largest economic opportunities of the twenty-first century for several global growth sectors, including consumer electronics, EVs, and renewable energy. Elaborating on the decision, Finance Minister Nirmala Sitharaman said the incentives for manufacturers will help the country move towards the objective of "Self-Reliant India." In March 2019, the GOI established the National Mission on Transformative Mobility and Battery Storage under the "Make in India" campaign.<sup>152, 153</sup> India is leveraging its central, state-owned Energy Efficiency Services Limited (EESL) to serve as the leading procurer of technologies for the Indian market (e.g., EVs and charging infrastructure). EESL aggregates purchases of state-level electric utilities to tender large-scale procurements. Additionally, this state-owned enterprise has partnered with a United Kingdom firm to invest in global projects, including a \$12 million investment in a battery project in Ontario, Canada.<sup>154</sup> Indian firm Greenko Energy Holdings also emerged in November

---

146 Road and Track, "2020 Volkswagen ID.3 Electric Hatch Will Offer Up to 341 Miles of Range", September 9, 2019. <https://www.roadandtrack.com/new-cars/a28968767/2020-volkswagen-id3-electric-hatch-pictures-range-specs-info-price/>. Accessed April 27, 2021.

147 Auto Express, "Volkswagen ID.3 vs Volkswagen e-Golf". <https://www.autoexpress.co.uk/volkswagen/e-golf/107409/volkswagen-id3-vs-volkswagen-e-golf>. Accessed April 27, 2021.

148 BloombergNEF, "Finland's Performance on BNEF's lithium-ion battery supply chain ranking," <https://www.bnef.com/shorts/10129>. Accessed April 27, 2021.

149 Business Finland, NATIONAL BATTERY STRATEGY: A FRAMEWORK FOR A COMPETITIVE AND SUSTAINABLE BATTERY INDUSTRY, March 2, 2021. <https://www.businessfinland.fi/en/whats-new/news/2021/national-battery-strategy-a-framework-for-a-competitive-and-sustainable-battery-industry>

150 [https://niti.gov.in/writereaddata/files/document\\_publication/India-Energy-Storage-Mission.pdf](https://niti.gov.in/writereaddata/files/document_publication/India-Energy-Storage-Mission.pdf). Accessed April 27, 2021.

151 PIB Delhi, "Cabinet approves PLI Scheme to 10 key Sectors for Enhancing India's Manufacturing Capabilities and Enhancing Exports – Atmanirbhar Bharat", <https://pib.gov.in/PressReleasePage.aspx?PRID=1671915>. Accessed April 27, 2021.

152 PM India, [https://www.pmindia.gov.in/en/news\\_updates/cabinet-approves-national-mission-on-transformative-mobility-and-battery-storage/](https://www.pmindia.gov.in/en/news_updates/cabinet-approves-national-mission-on-transformative-mobility-and-battery-storage/). Accessed April 27, 2021.

153 The GOI is in the process of consolidating the National Mission on Transformative Mobility and Battery Storage and the National Mission on Energy Storage (targeted at grid storage) into one cohesive strategy.

154 Energy Storage News, <https://www.energy-storage.news/news/indian-government-backed-jv-invests-us12m-in-ontario-battery-project>. Accessed April 27, 2021.



2020 as the preferred buyer for U.S. company NEC Energy Solutions, which holds IP rights for megawatt-scale lithium-ion batteries.<sup>155</sup>

## **JAPAN AND SOUTH KOREA**

Japanese and South Korean manufacturers are involved in most battery cell production investments outside of the Chinese market. Their domestic EV markets are not driving substantial growth, so most of their new cell production investments to this point are not occurring within Japan or Korea. Instead, investments are occurring in the larger Chinese, European, and North American markets. However, Japan doubled its EV purchase incentive to approximately \$7,700 (¥800,000) per vehicle in December 2020, which should lead to increased sales in the Japanese market.<sup>156</sup> The Government of Japan also recently announced plans to ban gasoline-only car sales by the mid-2030s. Likewise, in July 2020, Korea extended its EV subsidies to 2025.<sup>157</sup>

## **DEFENSE PARTNERSHIPS**

### **Five Eyes (FVEY) and The Technical Cooperation Program (TTCP)**

The multilateral alliance between Australia, Canada, New Zealand, the United Kingdom, and the United States represents an enduring and stable alliance that serves the interests of U.S. national security. TTCP provides mechanisms for cooperation on defense, science, and technology concerns. However, the FVEY also participate collectively in other related defense activities such as ABCA Armies, Air and Space Interoperability Council, AUSCANNZUKUS (navies), FVEY (intelligence), and the UKUSA agreement. The multilateral and enduring nature of these collaborations suggest that partnerships for supply chain security within the FVEY are low risk, and the groundwork for mechanisms to engage in partnerships already exist.

## **OTHERS**

Through the ERGI, led by State, and the defense community, partnerships exist with Botswana, Canada, Peru, New Zealand, and the United Kingdom. These partnerships present an opportunity to be expanded to the battery ecosystem.

## **OPPORTUNITIES & CHALLENGES**

### **NATIONAL SECURITY**

In addition to the economic imperative for a competitive EV and advanced battery sector, DOD requires reliable, secure, and advanced energy storage technologies to support critical missions carried out by joint forces, contingency bases, and military installations. Faced with increasing kinetic and non-kinetic threats, DOD is shifting toward more distributed, austere, and autonomous operational concepts carried out by platforms and installations with escalating power requirements. As such, DOD prefers domestically sourced, high-density energy storage to support agile forces utilizing power-hungry propulsion, communications, sensors, and weapons. However, the DOD supply chain is challenged due to the unique nature of batteries for weapons systems, as well as constituting only a small percentage of the larger commercial market for advanced batteries. As advanced lithium-ion batteries become strategically important, so too do assured sources of critical minerals and materials needed to sustain a robust and resilient domestic industrial base.

Given the importance of lithium batteries to the warfighter, assured sources of critical minerals and materials and both domestic and allied capability for lithium cell and battery manufacturing are critical to U.S. national security. The supply chain security of minerals, materials, cells, and battery components is of concern today.

---

<sup>155</sup> Livemint, <https://www.livemint.com/industry/energy/greenko-emerges-preferred-buyer-for-nec-corp-s-us-unit-for-300-million-11606202343984.html> . Accessed April 27, 2021.

<sup>156</sup> Inside EVs, "Japan Doubles Subsidies On Plug-In Electric Cars", <https://insideevs.com/news/461183/japan-doubles-subsidies-on-plug-ins/>. Accessed April 27, 2021.

<sup>157</sup> Pulse News, "Korea to extend subsidies for electric cars to 2025 to support green New Deal", July 17, 2020. <https://pulsenews.co.kr/view.php?year=2020&no=733375>. Accessed April 27, 2021.

Yet the rising demand and diversity of applications for lithium battery technologies within DOD, the decreasing role of defense in driving commercial lithium battery markets, and the prominence of adversary influence over supply make the future strategic concern even graver. To meet surface, undersea, space, air, and ground operational requirements, DOD will need reliable and secure advanced storage technologies.<sup>158</sup>

159, 160, 161, 162, 163, 164

## Authorities

Available authorities to direct defense acquisition or influence domestic industry in the interest of national security include the Industrial Base Analysis and Sustainment (IBAS) and Manufacturing Technology programs under Title 10 U.S.C., the Defense Production Act (DPA), the Buy American Act, and the National Defense Stockpiling (NDS) Act under Title 50 U.S.C. In addition, the Committee on Foreign Investment in the United States (CFIUS) reviews certain individual foreign investment transactions for national security risk, including transactions involving critical supply chains, and addresses such risk in the context of each specific transaction.

The IBAS program is dedicated to ensuring that DOD is positioned to more effectively and efficiently address industrial base issues and support the National Security Innovation Base. The IBAS program, directed in Title 10 U.S.C. Section 2508, is one of the key analysis and investment tools of the Industrial Policy office. IBAS identified the erosion of the U.S. rechargeable and non-rechargeable battery industry as a concern in the FY20 Industrial Capabilities Report to Congress, yet industrial base efforts to-date have been uncoordinated across DOD and the Federal Government and inefficient due to the lack of DOD-wide visibility into battery use and fielding requirements.

The Buy American Act, 41 U.S.C. 8301, and similar provisions in 10 U.S.C. 2533b and 10 U.S.C. 2533c, place restrictions on end items and components containing foreign specialty metals. Together, these provisions aim to limit the presence of foreign-sourced materials and products. However, the imperatives of mission requirements and cost, and the often-small percentage that a battery represents in an overall system, have limited the effectiveness of these authorities in fostering a domestic industrial base for advanced batteries.

CFIUS, operating pursuant to Section 721 of the DPA and regulations of chapter VIII of the Code of Federal Regulations, Title 31, is the interagency committee authorized to review certain transactions involving foreign investment in the United States in order to determine the effect of those transactions on U.S. national security. CFIUS review is generally a voluntary process, though some transactions are subject to a mandatory filing requirement. CFIUS relies on the expertise of its member agencies, including DOD, in reviewing individual transactions for national security considerations.

The NDS Act authorizes the President to determine which materials are strategic and critical for the purposes of national defense. The Defense Logistics Agency Strategic Materials (DLA-SM) provides operational

---

158 Assessing and Strengthening the Manufacturing and Defense Industrial Base and Supply Chain Resiliency of the United States. September, 2018. Accessed May 25, 2021.

159 Offshore Battery Production Poses Problems for Military (nationaldefensemagazine.org). November 18, 2018. Accessed May 25, 2021.

160 Evaluation of DoD Contracting Officer Actions on Questioned Direct Costs (Project no. D2019-DAPOCF-0130.000) (defense.gov) April 23, 2019. Accessed May 25, 2021.

161 US Navy Electric Ship Program Office Presentation, April 23, 2019.

[https://ests19.mit.edu/2019\\_ESTS\\_Program.pdf](https://ests19.mit.edu/2019_ESTS_Program.pdf). Accessed May 25, 2021.

162 Industry White Paper: Industry Perspective on the American-Made and Defense Industrial Base regarding Lithium Ion Batteries and Technology, May 3, 2019. Accessed April 14, 2021.

163 FP Analytics Testimony – U.S Senate Committee on Energy and Natural Resources, September 17, 2019. Hearings - U.S. Senate Committee on Energy and Natural Resources. Accessed April 14, 2021.

164 Benchmark Mineral Intelligence Testimony – US Senate Committee on Energy & Natural Resources Committee. February 5, 2019. 6A3B3A00-8A72-4DC3-8342-F6A7B9B33FEF (senate.gov). Accessed April 14, 2021.

oversight and is the field operator for the NDS Program. In this capacity, DLA-SM assesses the supply chains for a large and growing number of materials needed by the United States to produce goods and services for national defense and the essential civilian economy. Materials selected for study in the NDS Program's biennial Strategic and Critical Materials Report to Congress on Stockpile Requirements (Requirements Report) must pass through a rigorous, data-driven screening process that evaluates several variables including production concentration, market growth, and import vulnerability.

The Requirements Report models material demand and supply against a declared national emergency consisting of a conflict with a near-peer and an attack on the homeland. During the postulated national emergency, supplies of materials from unreliable countries are decremented either in part or in whole. These supply restrictions combined with elevated demands for materials can lead to potential shortfalls. Materials that present as potential shortfalls are candidates for stockpiling or other mitigation actions, such as qualification of new sources of supply. With Congressional approval, the NDS Program can stockpile materials that project to be in shortfall during the postulated national emergency. Currently, the NDS Program assesses all the major materials required for high-capacity batteries. Further, the NDS Program currently stockpiles several lithium-containing battery precursor materials. The specificity of material composition and structure required for state-of-the-art cells and batteries limits the effectiveness of materials stockpiling authorities. Methods to address those limitations, and standardize cell components, have not been fully explored.

### **Organizational Authority and Initiatives within DOD**

As a source of energy used to train, move, and sustain military forces and weapons platforms, DOD considers batteries used in combat platforms to be operational energy. Title 10 of the U.S.C., Section 2926, assigns the Assistant Secretary of Defense for Energy, Installations, and Environment (ASD(EI&E)) with responsibilities that include overseeing operational energy activities and making recommendations to the Secretary of Defense regarding policies and investments affecting the use of operational energy across the Department. The same statute requires that the Services designate a senior official responsible for overseeing operational energy plans and programs. Distinct from these energy communities, DOD also has extensive and established communities of technical expertise on materials.

### **Domestic Innovation**

#### *Emerging Technologies*

There are many emerging lithium battery technologies that promise improved performance. For years, U.S. institutions have been at the forefront of this research, often only to see that technology purchased and implemented overseas. U.S. leadership in R&D presents an opportunity to establish domestic production of future battery technologies, thus allowing the United States to leapfrog our competitors in the battery cost and performance race. Some sample technologies include, but are not limited to the following:

- **Silicon Anodes** have a theoretical lithium storage capacity 10 times that of currently used graphite. Silicon is a naturally abundant and low-cost material, and models show that silicon can reduce battery costs below \$100/kWh compared to current costs of \$150-175/kWh.<sup>165</sup> Challenges with silicon anodes include volume expansion challenges and calendar life issues.<sup>166</sup> Such issues are currently being investigated by researchers. Raw material sources for silicon, including polycrystalline silicon, silicon oxides, and silane gas, are fairly ubiquitous, and large-scale production of polysilicon was originally centered in the United States. Five facilities, located in Michigan, Tennessee, Montana, Alabama, and

---

165 D. Lila. "Achieving Tesla's 56 percent battery cost reduction strategy—with available material technology." PV Buzz. Sept. 23, 2020. <https://pvbuzz.com/tesla-battery-cost-reduction-strategy/>. Accessed Apr. 6, 2021.

166 Jin, Y., Zhu, B., Lu, Z., Liu, N., Zhu, J., Adv. Energy Mater. 2017, 7, 1700715. <https://doi.org/10.1002/aenm.201700715>. Accessed April 14, 2021.

Ohio, produce polysilicon from silanes (generated on-site) in the United States.<sup>167</sup> A sixth facility, located in Washington and, at the time, the third-largest polysilicon plant in the United States, was closed in 2019 and scheduled to be sold; however, in 2020, the owner, Norwegian company REC Silicon, formed a partnership with Group14 Technologies, a lead domestic manufacturer of silicon-based anode batteries, to restart the plant.<sup>168</sup>

- In spite of an early advantage in polysilicon production (87 percent of total global production in 2004), significant ground has been lost to China in the intervening years as China built and strengthened its supply chains for the photovoltaic and semiconductor industries.<sup>169</sup> U.S. production of polysilicon comprised less than 10 percent of total global production in 2020. Further complicating supply chain matters are the credible charges of forced labor in the production of polysilicon in Xinjiang Uyghur Autonomous Region (XUAR).<sup>170</sup> The Solar Energy Industry Association (SEIA) is actively encouraging its members to shift their dependence on XUAR-based polysilicon to more transparent and ethical suppliers by mid-2021.<sup>171</sup> SEIA also introduced a "traceability protocol" for the solar supply chain, but it requires an independent third party auditor.<sup>172</sup> R&D funded by DOE's VTO has addressed cycle life issues with silicon anodes (from 100 to >1,000 in the past five years). Continued DOE-funded R&D is focused on the reactivity with current electrolytes and electrode stability due to silicon volume change during cycling.<sup>173-174-175-176-177-178-179</sup>

---

<sup>167</sup> BloombergNEF, "Equipment Manufacturers – PV 2020" Interactive Database. Available for purchase. Accessed December 14, 2020.

<sup>168</sup> "Globe News Wire, "REC Silicon - Group14 Technologies and REC Silicon Announce U.S. Advanced Silicon Anode Production Facility to Meet Demand for 'Electrification of Everything' Decade", October 13, 2020. [Online]. <https://www.globenewswire.com/news-release/2020/10/13/2107180/0/en/rec-silicon-group14-technologies-and-rec-silicon-announce-u-s-advanced-silicon-anode-production-facility-to-meet-demand-for-electrification-of-everything-decade.html>. Accessed April 14, 2021.

<sup>169</sup> BloombergNEF, "China invests \$29 billion to beat U.S. semiconductors", November 5, 2019. <https://about.bnef.com/blog/china-invests-29-billion-to-beat-u-s-semiconductors/>. Accessed May 25, 2021.

<sup>170</sup> Sheffield Hallam University, "In Broad Daylight: Uyghur Forced Labour and Global Solar Supply Chains, <https://www.shu.ac.uk/helena-kennedy-centre-international-justice/research-and-projects/all-projects/in-broad-daylight>. Accessed May 25, 2021.

<sup>171</sup> SEIA, "Solar Companies Unite to Prevent Forced Labor in the Solar Supply Chain", February 4, 2021 <https://www.seia.org/news/solar-companies-unite-prevent-forced-labor-solar-supply-chain>. Accessed May 25, 2021.

<sup>172</sup> SEIA, "Solar Supply Chain Traceability Protocol", <https://www.seia.org/research-resources/solar-supply-chain-traceability-protocol>. Accessed May 25, 2021.

<sup>173</sup> M. Ashuri, Q. He, L.L. Shaw. "Silicon as a potential anode material for Li-ion batteries: where size, geometry and structure matter," *Nanoscale*, 8, (2016) 74. doi: 10.1039/C5NR05116A. Accessed April 14, 2021.

<sup>174</sup> W. Li, X. Sun, Y. Yu. "Si-, Ge-, Sn-Based Anode Materials for Lithium-Ion Batteries: From Structure Design to Electrochemical Performance," *Small Methods*, 1, 1600037 (2017). doi: 10.1002/smt.201600037. Accessed April 14, 2021.

<sup>175</sup> A.F. Gonzalez, N.-H. Yang, R.-S. Liu. "Silicon Anode Design for Lithium-Ion Batteries: Progress and Perspectives." *J. Phys. Chem.*, 121 (2017), 27775 doi: 10.1021/acs.jpcc.7b07793. Accessed April 14, 2021.

<sup>176</sup> G. Lui, S. Xun, N. Vukmirovic, X. Song, P. Olalde-Velasco, H. Zheng, V.S. Battaglia, L. Wang, W. Yang. "Polymers with Tailored Electronic Structure for High-Capacity Lithium Battery Electrodes," *Advance. Mater.* 23 (2011), 4679. doi: 10.1002/adma.201102421. Accessed April 14, 2021.

<sup>177</sup> C. Wang, H. Wu, Z. Chen, M.T. McDowell, Y. Cui, Z. Bao. "Self-healing chemistry enables the stable operation of silicon microparticle anodes for high-energy lithium-ion batteries," *Nature Chem.* 5 (2013) 1042. doi: 10.1038/nchem.1802

<sup>178</sup> J. Choi, D. Aurbach. "Promise and reality of post-lithium-ion batteries with high energy densities," *Nature Rev. Mater.* 1 (2016) 16013. doi: 10.1038/natrevmats.2016.13. Accessed April 14, 2021.

<sup>179</sup> E.M. Erickson, E. Markevich, G. Salitra, D. Sharon, D. Hirschberg, E. de la Llave, I. Shterenberg, A. Rosenman, A. Frimer, D. Aurbach. "Development of Advanced Rechargeable Batteries: A Continuous Challenge

- **Lithium Metal Anodes** are seen as the ultimate goal for improving battery energy and cost. Lithium has over 10 times the storage capacity of currently used graphite, but suffers from poor cycle life and occasional safety issues. Lithium metal batteries are being pursued on two parallel pathways: with liquid electrolytes, often modified recipes of conventional lithium-ion electrolytes, and with solid electrolytes.<sup>180</sup> There are two potential methods for high-volume manufacturing of lithium metal anodes. For high-capacity anodes, lithium metal foils of >20-micron thickness would be produced from metallic lithium ingots by extrusion, and then applied to the current collector and/or electrolyte (in the case of solid-state batteries) by lamination. Minimizing excess lithium raises battery energy density but films of thickness <20 micron would have to be produced by an evaporative process, most likely physical vapor deposition. The DOE VTO Battery500 Consortium has improved energy and cycle life from 250Wh/kg and 50 cycles to 350Wh/kg and 400 cycles over the past four years. DOE is also funding thin film (<20-micron) lithium metal production efforts.
- **Solid-State Batteries** have the potential to facilitate use of lithium metal and silicon-based anodes, and increase safety through the elimination of flammable liquid electrolytes. Currently, issues with life and power severely limit solid state battery use. There are three categories of solid-state electrolyte (SSE): polymer-based, sulfide-based, and ceramic- (metal oxide-) based. Each faces challenges in cell performance and high-volume manufacturing. U.S. researchers are at the forefront of this work, and rapidly scaling a successful solid-state battery supply chain should be a priority to the United States. This means adequately funding innovative R&D and then rapidly shifting resources to set up a domestic supply chain when a breakthrough is achieved, and being prepared to do so by advance planning along parallel pathways for different electrolyte candidates. There will be a significant advantage to early movement on this technology once its benefits are realized as companies in other countries already recognize the utility of solid-state batteries. One common challenge for solid state cells is the ability to meet both power and cycle life requirements in large, automotive format (10Ah or larger) cells. Thus, if a candidate solid state technology is scaled to perform in cells of that size and demonstrates the ability to meet EV power and cycle life requirements, then further scale up and supply chain capture should become a priority.
- **Next-generation Cathodes** are needed to substitute for today's cathodes which use critical materials such as cobalt and nickel. There is potential for the use of novel higher capacity cathodes based on abundant and inexpensive elements such as sulfur, iron, manganese, or even air-based cathodes. Such systems, despite their potentials for higher energy than commercially available EV batteries, are far from commercial realization, as their cycle life is poor.

### Regional economic growth

As mentioned above, sub-component and cell manufacturing tracks closely with downstream manufacturing, demonstrating the desire for co-location of suppliers. Sub-component manufacturing is largely concentrated in the Midwest and Southeast regions of the United States. Economic growth is expected in these areas. Existing programs to support domestic innovation ecosystems are important resources (e.g., Small Business Administration's Regional Innovation Clusters and Federal and State Technology partnership, as well as Commerce's Economic Development Administration Build to Scale).

Cell manufacturing has also largely followed downstream demand centers (e.g., Tesla's Gigafactory being built close to California's large demand.) Demand centers have grown in response to policy incentives to promote

---

in the Choice of Suitable Electrolyte Solutions," *J. Electrochem. Soc.* 162 (2015) A2424. doi: 10.1149/2.0051514.jes. Accessed April 14, 2021.

<sup>180</sup> D. Lin, Y. Liu, Y. Cui. "Reviving the lithium metal anode for high-energy batteries." *Nature Nanotech.* 12 (2017) 194. doi: 10.1038/NNANO.2017.16. Accessed April 14, 2021.

the adoption of EVs and, to a much lesser extent, stationary battery storage. Economic growth is expected in areas with policy incentives.

### **Marginalized communities**

Policy support for the battery supply chain must include a focus on advancing equity for historically underserved and marginalized communities including people of color, Tribal communities, and those who have been adversely affected by persistent poverty and inequality. This includes conducting rigorous community consultation in the siting and permitting of all industrial sites and facilities and ensuring equity in access to the new clean energy jobs that will be created to meet growing demand. These efforts, which will include implementation of the Justice 40 Initiative, will ensure a more equitable and durable supply chain that works for all Americans.

### **Small and Medium Enterprises and Minority Business Enterprises**

There is a strong history of innovation in U.S. small businesses. This includes many success stories in the battery space, often funded under the Small Business Innovative Research (SBIR) and Small Business Technology Transfer (STTR) programs.

One challenge often cited is that innovative small businesses face major obstacles in attracting domestic capital needed to commercialize their technology and IP during intermediate phases of technology development for material and process scale-up; it is often easiest to raise start-up capital abroad. This leaves Chinese or other foreign investment as the sources of needed funds. Some of the main reasons for hesitation cited by private investors centers on the longer development times that battery technologies need before going public. This timing need is especially stark in comparison with other Silicon Valley start-ups, where the time for a product to market is often measured in months versus the years required for battery start-ups. To increase the economic potential effort, there should be additional investigation conducted on ways to incentivize this community of entrepreneurs, ways the government can work with private investment to better utilize private capital, and the most appropriate role in government for this "bridge funding" for start-ups, with an increased emphasis on providing access to underserved communities.

## **RECOMMENDATIONS**

Lithium batteries are an essential element of the EV market, accounting for up to half of the consumer cost of an EV. Batteries also play an important role in the transition to renewable electricity by providing storage for power used during periods of lower electricity generation. In the coming decades, U.S. leadership in both automotive manufacturing and renewable energy technology will depend heavily on near-term U.S. positioning as a leader in lithium ion and other high-capacity batteries. The United States must increase competitiveness with Asia, where Chinese EV sales are three times larger than sales in the United States and a majority of batteries are manufactured today, and Europe, where the spread of EVs is outpacing the United States in large part due to European policy support. The United States must adopt a set of tools to increase domestic battery manufacturing while improving the resilience of the lithium battery supply chain, including the sourcing and processing of the critical minerals used in battery production. Collaboration across the Federal Government, corporate stakeholders, the research community, workers, and international allies will be an integral feature of our strategy.

Principally, policy support should bolster the domestic supply chain by advancing demand for U.S.-made batteries, and spurring the development of both a stronger manufacturing base and a resilient supply chain. As a part of the American Jobs Plan, President Biden has called for transformational investments to spur this demand, including \$100 billion in incentives to encourage U.S. consumers to transition to EVs, \$15 billion to build out a national EV charging infrastructure, and plans to transition both the Federal vehicle fleet and state and local government fleets to EVs. Paired with President Biden's plans to boost domestic battery manufacturing capacity and to invest in R&D to support the development of next generation batteries, this funding will position the United States as a leader in battery manufacturing.

Policy tools must also bolster resilient supply chains for essential upstream critical minerals and materials through a broad set of strategies to increase the supply of sustainably produced minerals and metals and build refining and processing capacity needed to support manufacturing.<sup>181</sup> Given the historical legacy of mining in the United States, particularly on indigenous lands, the Federal Government will hold any new and existing raw mineral production to the strongest environmental and labor standards, and production will come only after meaningful engagement with affected communities, including government-to-government consultation with Tribal nations. Significant updates to the laws and regulations governing domestic resource extraction and mining may be required to ensure that these standards can be achieved. Preference should be given to new mines that would involve lower-impact sources or locations that would not conflict with other valuable resources or land-uses, and prioritize, when possible, economic development opportunities for impacted communities.

Resilient supply chains will require new programs for the recycling and recovery of critical materials from products at the end of their life, as well as other unconventional sources, like minerals extracted from coal and other mine waste, that can minimize the need for new mining operations. Over the mid- and long-term, R&D will identify and commercialize the use of alternative, earth abundant materials and practices that reduce the quantity of critical minerals needed in lithium batteries. The following recommendations outline the scope of public investments required to secure lithium battery supply chains and U.S. competitiveness. These include actions the Biden Administration can take immediately and without Congressional action, investments that Congress must make to support economic growth in the battery market, and a research agenda to help the United States sustain leadership in battery technology.

These recommendations identify the following Federal policies and investments:

### **1. Stimulate Demand for End Products Using Domestically Manufactured High-Capacity Batteries**

Battery cell and pack production tend to co-locate with the end products in which the batteries are used. To support the establishment of a robust high-capacity battery manufacturing industry, it is necessary, though not sufficient absent broader coordinated action, to stimulate demand for and domestic production of end products, primarily EVs and power storage for the renewable electric grid.

Over the past decade, global sales of lithium batteries for both EVs and for power grid storage have risen dramatically.<sup>182</sup> Between 2011 and 2020, global sales of EVs rose more than 75-fold, from less than 40 thousand to 3.1 million.<sup>183</sup> Of those 3.1 million, however, only 300,000 were sold in the United States, less than two percent of total auto sales in 2020. While the United States will see EV growth even absent policy interventions, countries that are leading the global transition to EVs and carving out leadership positions in EV manufacturing are projected to remain substantially ahead absent effective U.S. policy. This risks hollowing out the U.S. manufacturing base and undermining America's long-term technological edge.

The Administration should pursue a whole of government approach to stimulating domestic demand and production of EVs and stationary storage through Federal purchases, consumer incentives, and standard setting. The following recommendations aim to create an early market demand of over 450 GWh of battery production, about 60 percent of the 2020 global capacity, and would support jobs in transportation, manufacturing, and deployment.

---

<sup>181</sup> For select metals, this will include production and processing.

<sup>182</sup> Vehicles are typically segmented by end-use class: passenger cars, light-duty vehicles, medium-duty vehicles, and heavy-duty vehicles. Within these vehicle segments, there are several different types of EV categories. These include “hybrid”, “plug-in hybrid”, “fuel cell”, and “battery” EVs. For this paper, EVs from this point on are defined as highway capable, light-duty, battery, and plug-in hybrid EVs.

<sup>183</sup> Bloomberg New Energy Finance annual EV sales data downloaded March 9, 2021.

## **Support Demand for Batteries in the Transportation Sector**

Increasing demand for batteries in the U.S. transportation sector requires both spurring demand by businesses and households, which represent a majority of U.S. vehicle demand, and also increasing demand by the Federal government and by state, local, and Tribal governments, which can serve as early adopters and help drive overall uptake of EV technology.

### **Electrifying the Federal Vehicle Fleet and State, Local, and Tribal Government Fleets**

The Federal vehicle fleet consists of approximately 640 thousand vehicles worldwide, excluding military combat vehicles and other tactical vehicles. Of these vehicles, approximately one-third are owned by the U.S. Postal Service, and the remainder are either leased by agencies from the General Services Administration (GSA) or are agency-owned. The current share of EVs and other zero emission vehicles (ZEVs) in the Federal fleet is less than one percent of the total.<sup>184</sup>

Congress should appropriate funds to GSA to speed up the conversion of the Federal fleet to ZEVs, both through its leasing program and through regranting dollars to agencies who wish to purchase ZEVs. There is significant potential to move quickly in converting the Federal fleet of 640,000 vehicles to commercially available ZEVs. To maximize the domestic economic impact, incentives should be offered to maximize the domestic content in batteries in fleet vehicles. Converting the Federal fleet to EVs would support over 64 GWh of domestic battery production.<sup>185</sup>

State, local, and Tribal governments also maintain substantial vehicle fleets, which are estimated to comprise over two million light-, medium-, and heavy-duty vehicles, with approximately five percent of that total being ZEVs. A new Federal program to encourage local, state, and Tribal governments to fully convert their fleets to ZEVs would support over 200 GWh of domestic battery production.<sup>186</sup>

### **Electrifying the Nation's School Bus Fleet**

New Federal grant funding through the Environmental Protection Agency (EPA) or DOE should be used to subsidize the incremental up-front cost of new school buses, charging infrastructure, and workforce training to accelerate the transition from diesel and provide funding certainty for suppliers to expand their production lines. Initial estimates indicate \$20 billion could support transitioning 20 percent of the existing school bus fleet to ZEVs. A approximately 95 percent of America's school buses currently run on diesel; to-date, limited Federal funds have been available to support transitions to ZEVs despite the documented climate and health benefits of moving from diesel to battery electric propulsion.

At the end of 2020, approximately 650 electric school buses were in operation in the United States, mostly used as demonstration vehicles or small pilots. The California Energy Commission runs California's school bus electrification grant program and has learned important lessons on how to ensure a successful grant program: one key lesson was the need to partner school districts with technical expertise, particularly in terms of new bus route planning and the locating of charging infrastructure. Therefore, any Federal grant program should be paired with technical assistance, support, and education. Additionally, it is important that equitable pathways be developed so that all communities can benefit from reduced emissions, perhaps through targeting low-income school districts first or providing higher matching funds for disadvantaged communities. Incentives must be significant and reasonably easy to access both in the application phase and funds distribution phase.

### **Electrifying the Nation's Transit Bus Fleet**

Congress should provide additional funding through the Federal Transit Administration's Low and No Emissions (Lo-No) grant program to accelerate adoption of zero emission transit vehicles by providing

---

<sup>184</sup> This represents approximately 1,600 vehicles.

<sup>185</sup> Assuming an average 100 kWh battery capacity for each vehicle.

<sup>186</sup> Assuming an average 100 kWh battery capacity for each vehicle.



capital funding for transit agencies to procure new buses and charging infrastructure, creating market certainty for manufacturers to build production capacity. Initial estimates indicate that a \$25 billion program could support replacing 20,000 transit vehicles, including buses, but also smaller shuttles, vans, and cars operated by transit agencies.

Transit agencies operate more than 84,000 diesel and gasoline transit vehicles, including buses. Many agencies have made bold commitments toward full electrification, but full-scale deployments have been limited due to concerns about higher capital costs, battery range, performance in cold climates, manufacturing capacity, and overall change management.

#### *Support “Point-of-Sale” Rebates for Consumers and a Tax Incentives for Medium and Heavy-Duty Vehicles, With a Preference for U.S. Content*

The existing Federal incentive program for EVs, first adopted in 2010, helped popularize EVs for American consumers and currently provides some EV buyers a Federal tax credit of up to \$7,500 for the purchase of an EV. However, several important reforms would strengthen the program.

First, Congress should amend the program to offer “point-of-sale” rebates for consumers who buy EVs, rather than offering tax credits to EV customers who file tax returns seeking them. Point-of-sale rebates are easier to access and more tangible for consumers, make EVs cheaper for all buyers at the time they make their purchasing decision, and benefit all customers, not just those with tax liabilities that exceed the value of the tax credit. Second, Congress should amend the program to offer a higher value rebate for EVs that meet higher domestic content thresholds and which conform to high labor standards, creating an incentive to onshore key parts of the supply chain, including batteries. Third, Congress should enact a new tax credit for medium and heavy-duty EVs, such as trucks, which are a significant contributor to local air pollution as well as global greenhouse gas emissions.

#### **Support the Build Out of EV Charging Infrastructure**

“Range anxiety”, the concern that an EV will run out of power on the road, and lack of publicly available charging infrastructure remains a barrier to light-, medium-, and heavy-duty plug-in EV adoption, especially in underserved communities. Moreover, consumer tax credits are generally not available to local, state, and Tribal governments, which do not typically pay Federal taxes. A Federally-supported, nationwide buildout of 500,000 EV chargers is critical to the wide-scale adoption of EVs by general public. A nationwide charging station buildout is also essential to encouraging EV adoption by the Federal fleet and by state, local, and Tribal government fleets, which also require access to reliable charging infrastructure given the use demands typically placed on fleet vehicles.

To meet this need, President Biden has called for \$15 billion in Federal funding to support the build out America’s EV charging infrastructure.

#### **Support Strong Energy Efficiency and Tailpipe Emissions Standards for All Vehicles**

Updating efficiency and tailpipe emissions standards for gasoline powered vehicles will reduce carbon emissions and other pollution while ensuring that gasoline vehicles reflect the true costs of use, including environmental costs. The EPA and Department of Transportation (DOT) should undertake a process to update efficiency and tailpipe standards for all vehicles to account for improvements in cost and performance of more efficient and cleaner technologies. New efficiency and emissions standards will likely spur additional demand for EVs given that expanded EV sales, as ZEVs, help automotive companies meet overall fuel efficiency standards across their product lines.

#### **Support Demand for Batteries for the Utilities Sector**

While EVs constitute the dominant share of lithium batteries today, electrical power storage is emerging as an important additional driver of demand. Power storage occurs at both the grid level, such as large-scale storage adjacent to solar facilities to allow power to be stored during the day and drawn down at night, and at

the residential and business level, where homeowners and businesses are beginning to turn to batteries as an alternative to backup generators. Spurring demand for U.S.-made batteries for such storage will help drive U.S. battery manufacturing.

### **Accelerate Federal Battery Storage Procurement**

In support of the Administration's goal for a 100 percent clean electricity grid by 2035, the Federal Energy Management Program (FEMP), housed at the DOE, should call for Federal agencies to procure stationary battery storage for Federal facilities in addition to procuring other types of stationary storage. FEMP should provide technical assistance to agencies to support them in carrying out the procurement of these storage technologies. Additionally, procuring 100 percent of Federal electric supply from clean energy sources that are delivered time-matched with Federal facility demand could help support the demand for flexibility resources such as stationary storage.

*Expand the Internal Revenue Service (IRS) Section 48 and 25D Investment Tax Credit (ITC) to include stationary storage as a stand-alone resource*

Congress should expand the Section 48 and 25D ITCs to include stationary storage, as they currently do not apply, and authorize new tax credits. Tax credits can increase the demand for local manufacturing. While EVs are likely to be the primary driver of lithium storage, grid applications are likely to expand significantly as more variable wind and solar power comes online. Ensuring storage technologies are available for the same tax credit as renewable energy generation sources will help drive scale, further cost reduction, and diversify the market base. The Energy Storage Tax Incentive and Deployment Act introduced in March 2021 would expand the ITC to storage.

*Institute Power Transmission Regulatory Reform to support Renewable Power and Stationary Energy Storage*

The Federal Energy Regulatory Commission should consider an accelerated rulemaking for creating a framework for storage-as-transmission-asset, on regulatory treatment for hybrid resources with a focus on storage and renewable sources, and qualifying facility eligibility. These rules would remove barriers to grid storage deployment, speeding up long-term demand for domestic battery manufacturing. At the distribution level, clarification of the regulatory treatment for energy storage as having the potential to be treated as a distribution asset rather than a generating asset would open the market for utilities to more cost-effectively utilize energy storage to improve the resilience and efficiency of their distribution systems in restructured markets.

## **2. Strengthen Responsibly-Sourced Supplies for Key Advanced Battery Minerals**

A secure U.S. lithium-ion battery supply chain is dependent on a strong U.S. manufacturing base. But that manufacturing base is, in turn, dependent on upstream inputs, particularly key minerals and other materials that are required to manufacture batteries. Currently, many of the key inputs come from countries with a history of political instability, such as the DRC, which holds approximately 80 percent of the world's cobalt reserves, or countries that are geopolitical competitors of the United States, such as China, which has a dominant share of the processing of several key metals. Natural disasters and other events can also disrupt supply chains regardless of the source. The United States must secure a reliable supply base through both targeted international investments and a strong domestic supply base. Regardless of whether investments occur domestically or internationally, investments in both mining and processing must adhere to the highest environmental and social standards and ensure that they do not harm local communities, including historically disadvantaged and indigenous communities including native American tribes. Investments need to be made across the full product lifecycle, including extraction, refining and processing, and recycling.

Lithium-ion batteries are positioned for a major scale-up in demand over the next 10 years. To secure a resilient supply chain for a technology that will be so critical to our economy and to make the most of this economic opportunity, the United States should take a mineral-by-mineral approach to look for opportunities to sustainably produce and refine domestic minerals for key battery materials. For battery materials where the

United States does not have strong deposits suited for economic extraction, the best pathway to getting a stable material supply in the near-term is through allies and trading partners with responsible environmental and labor standards, and in the long-term by capturing and recycling the supply of materials in end-of-life batteries from EVs and storage. Both extracted and recycled materials and minerals will require refining and processing, and refining and processing capacity should be scaled up domestically to utilize this supply, capture an important stage of the supply chain that fuels downstream battery manufacturing, and avoid the need to export raw materials and re-import processed components.

### **Invest in targeted, mineral-specific strategies**

Different minerals call for different strategies. For some minerals, such as lithium, the United States has domestic supplies but the scale of U.S. production is currently outpaced by demand, and the United States does not always have full control of both mining and processing. For other minerals, such as cobalt, the United States will always be largely dependent primarily on foreign providers. For these minerals, the United States will either need to work with allies to secure supplies or support R&D that reduces the need for such minerals in future generation EV batteries.

#### *Support Sustainable Domestic Extraction and Refining of Lithium*

The United States has lithium resources and domestic corporations well-versed in recovery and refinement globally. Lithium resources exist in North Carolina (ore), Arkansas (brine), Nevada (brine, clay), and California (brine). Lithium project development is costly and producers face future costs that hamper project initiation. New projects typically require buyer contract agreements in advance of project start. To establish a sustainable domestic lithium supply chain, the United States should:

- Increase support for resource mapping at the USGS and the DOE to enable informed policy and investment decisions around production and refinement of lithium and other critical materials and minerals. The Federal Government should explore using purchase price and quantity guarantees for a stockpile serving as a backstop, providing loans or guarantees through DOE's Loan Program Office (LPO), leveraging the DPA including Title III and VII authorities to support extraction, and standing up new public financing streams.
- Modernize the U.S. laws and regulations governing mining on public lands, where many lithium resources in Nevada and California are located, in order to provide assurance to tribes and local residents that important environmental and cultural resources will be protected during and after mining operations.
- Support extraction and refinement efficiency through investment in R&D and commercialization support from DOE and other Federal partners. Technology that improves lithium yield could benefit both domestic and international sites, and by securing technology rights, the United States could position itself and domestic companies to benefit from licensing while opening the resource base.
- Invest in domestic refinement of ore, brine, or clay into lithium chemicals similarly through a potential mix of purchasing guarantees, the DOE LPO, the DPA, and new financing programs in concert with R&D investment to advance existing techniques. China's domestic investment in this field has made them the world's leader despite limited domestic lithium supply.
- Develop and expand technoeconomic models in line with international best practices to help identify the best areas for extraction development accounting for the latest mineral extraction techniques.

#### *Support Nickel and Cobalt Recovery from Recycled and Unconventional Sources:*

Tapping secondary sources for critical materials and minerals can alleviate demand from conventional extraction including from new mining. Actions to support recovery from recycled and unconventional sources include:

- Increase nickel supply by promoting battery recycling in the long term. As more and more EVs reach their end-of-life, spent EV batteries are expected to be an increasingly important source for nickel sulfate production. The United States could consider investing in battery recycling infrastructure and technology development.
- Increase nickel supply by exploring unconventional sources and secondary sources from remediation and reclamation such as acid-mine drainage, other acid-mine-impacted waters, mining wastes, drainage treatment sludges, abandoned mine tailings, slag, or heap/dump leach operations. Most of the in-use nickel is in stainless steel. However, it is not currently feasible to use stainless steel or other Class 1 nickel materials to produce nickel sulfate, which could be a future R&D focus.
- Increase cobalt supply by promoting battery recycling in the long term. Since cobalt is typically co-produced with nickel and/or copper, the supply of cobalt can be adversely affected by low nickel/copper prices, and the market price of cobalt has been quite volatile. To secure cobalt supply and guard against price fluctuations, the United States could consider investing in battery recycling infrastructure and technology development. Immediate focus should include investment to increase capacity and scale-up of recycling facilities, and investigation of pathways for early Federal purchase of recycling waste streams to the furthest extent possible.

#### *Invest in Nickel Refining in Coordination with Allies*

The United States does not have a strong presence in the nickel supply chain for several reasons: (1) production cost is not competitive to that of South American and Asian operations given globalization, alleged dumping, and excessive foreign government subsidization, (2) barriers to entry for new mines at the Federal, State, and local levels, and (3) limited U.S. nickel reserves. U.S. nickel refining capacity is currently limited and focuses on refining nickel salts (sulfate or carbonate) as a byproduct of platinum group metals or copper mining. Low material throughput and the lack of a lithium battery cathode market in the United States has limited expansion of these facilities. As demand for lithium batteries grows in the United States, the need for refined nickel material will grow dramatically. To meet this demand, Federal support for nickel refining capacity should flow through existing loan programs like LPO and economic development funds as well as new federal assistance levers from Congress like 48C manufacturing tax credits and supply chain grants.

#### *Identify Opportunities for Supporting Sustainable Production and Refining of Cobalt*

At present the nickel-cobalt Eagle Mine in Michigan is the only active cobalt mine in the United States. Eagle Mine produces cobalt-containing nickel concentrate, while a company in Missouri produces nickel-copper-cobalt concentrate from historic mine tailings. Within the United States, six companies produce cobalt chemicals, primarily from imported and secondary materials (scraps).<sup>187</sup> The United States does have some cobalt refining capability. If the United States increases cobalt materials throughput by using imported and recycled material, the downstream manufacturing to refine cobalt needs to be established. The Federal investments through loans, economic development funds, and potential new grants or tax credits described above to increase recycling and invest in refining and processing capacity would have a similar impact to scale up the domestic cobalt supply chain, removing risk and capturing economic opportunity.

#### *Work with Allies and Partners to Expand Global Production and Ensure Access to Supplies*

The United States cannot and does not need to mine and process all critical battery inputs at home; it can and should work with allies and partners to expand global production and to ensure secure global supplies. There are several steps that the United States should take to work with allies and partners to strengthen key global supplies:

---

<sup>187</sup> USGS. 2021. “Material Commodity Summaries 2021”, <https://pubs.usgs.gov/periodicals/mcs2021/mcs2021.pdf>

- Use the U.S. Development Finance Corporation (DFC) to expand production and processing of key metals: The DFC should identify projects in allied and partner nations that can be funded to create new sustainable mining and processing operations for lithium, graphite, and other key metals and materials.
- Use trade tools to strengthen critical mineral supplies: The new Supply Chain Trade Strike Force should examine both unfair trade practices that undercut the security of supplies of critical minerals, such as bans on exports by several countries, and the impacts of U.S. tariffs and other U.S. trade policies that may inadvertently create supply chain challenges for U.S. battery production.
- Promote the use of transparent competitive procurement and concession practices through foreign assistance programs abroad: The U.S. Government, including the United States Agency for International Development (USAID), should promote the institutionalization of transparent procurement and mineral extraction rights through policies, laws, and regulations. Building on U.S. government programs that enable competitive procurement of renewable energy and extractives industry transparency in assistance countries, USAID should promote competitive tenders for mining and sale of minerals needed for manufacturing of the batteries.
- Strengthen resources governance: The U.S. Government should work with allies and partners to strengthen resource governance and improve environmental and social standards. For example, the ERGI is a multilateral effort founded by Australia, Botswana, Canada, Peru, and the United States, and led by the State's Bureau of Energy Resources, to promote sound mining sector governance and resilient and secure energy mineral supply chains. ERGI aims to foster a just and sustainable energy transition and address associated supply-chain vulnerabilities. ERGI uses the experience of countries with mature mining industries to build the capacity of countries with significant critical energy mineral/element resources to sustainably develop their mining sectors and increase private investment in responsible mining projects that advance critical mineral supply chain resilience.
- Set global standards: The United States is participating in the ISO's TC for Lithium, ISO/TC 333. In this context U.S. experts from government, academia, and industry can work to ensure that international standards bodies for critical mineral inputs for the advanced battery industry are aligned with the U.S. Government's critical materials goals and are consistent with best practices for environmental, social, and governance standards, including domestic environmental regulations, Tribal and indigenous consultation, and the Administration's Executive Order on Tackling the Climate Crisis at Home and Abroad, including efforts to secure environmental justice and spur economic opportunity.

The Initiative for Responsible Mining Assurance (IRMA) is an international coalition of businesses, nongovernmental organizations, labor unions, mining operators, and other stakeholders that has developed a Standard for Responsible Mining and established a system for independently certifying mines worldwide that adhere to that standard. IRMA may provide a method for U.S. companies and the Federal Government to ensure that minerals are being sourced from mines with robust environmental, social, and financial responsibility policies, and also could provide a model for responsible development of additional mines in the United States.

### **Raise Labor and Environmental Standards Across the Board**

*Develop Strong Environmental Review Permitting Practices for the Extraction of Lithium, Nickel, Cobalt, and other key high-capacity battery minerals*

Federal agencies and state governments must hold raw mineral production to modern environmental standards, require best-practice labor conditions, and proceed with meaningful consultation with affected communities, including Tribal nations in government-to-government collaboration. The majority of U.S. mining laws and regulations have not been updated in over half-a-century. These require updates from Congress in addition to action that EPA can take in consultation with DOI and the Department of

Agriculture (USDA) under existing authorities (e.g., Clean Air Act, Clean Water Act, Endangered Species Act). Siting should consider prioritizing lower-impact sources such as already disturbed lands and economic development opportunities for impacted communities.

Achieving such high standards would require significant updates to the laws and regulations regarding mining in the United States. There are a number of statutory authorities that govern mineral development on Federal lands. For example, the General Mining Law (GML) of 1872 may apply to the exploration, development, and extraction on Federal lands of minerals such as lithium, nickel, and cobalt. Additionally, various statutory authorities govern permitting and environmental compliance of mineral development on Federal lands, including the Federal Land Policy and Management Act of 1976 for lands managed by the Bureau of Land Management and the Organic Act of 1897 for lands administered by the U.S. Forest Service (USFS). Other applicable environmental laws include the NEPA, the Clean Air Act, the Clean Water Act, and the Endangered Species Act.

Unlike for coal mining, there is no comprehensive statute that specifically addresses permitting and reclamation of mines for lithium, cobalt, nickel, copper, gold, uranium, and other minerals. To reduce conflict, provide increased certainty for industry, improve the environmental performance of mines, better engage Tribes and local communities, and protect taxpayers from the cost of remediating abandoned mines, Congress should enact comprehensive reform of the GML of 1872 and USDA and DOI should strengthen the regulations governing mining on public lands. States also have a significant role in review and permitting of mining projects.

The Federal Government should establish an interagency team with expertise in mine permitting and environmental law to identify gaps in statutes and regulations that may need to be updated to ensure new production meets strong standards before mining begins, during the mining process, and after mining ends; ensure meaningful community consultation (including with Tribal nations, respecting the government-to-government relationship) at all stages of the mining process; and examine opportunities to reduce time, cost, and risk of permitting without compromising these strong environmental and consultation benchmarks. These should include:

- Updated regulations, guidance, or policy from EPA that includes consistent and detailed requirements for mine plans and environmental baseline information subject to Federal decisions and the NEPA process to improve the consistency and quality of mine plans and permit applications.
- Review of mining regulations by EPA to determine if and where gaps exist that have resulted in challenges to mine permits or approvals and extended timelines.
- Sufficient resources for Federal agencies involved in NEPA and permitting and improved hiring of technical experts with knowledge of mining, mining waste management, reclamation practices, and environmental impacts evaluation of mining projects.
- Legislation from Congress to replace outdated mining laws including the GML of 1872 governing locatable minerals (including nickel) on Federal lands, the Materials Disposal Act of 1947 to dispose of minerals found on Federal lands, and the Mineral Land Leasing Act of 1920 among others. These should be updated to have stronger environmental standards, up-to-date fiscal reforms, better enforcement, inspection and bonding requirements, and clear reclamation planning requirements.

#### *Leverage Federal Investment to Incentivize Sustainable Practices*

Where the Federal Government is responsible for subsidizing or otherwise incentivizing domestic mineral production, the Government should take additional measures (beyond complying with sustainability standards) to ensure that the mining occurs in an environmentally protective manner over the entire mining lifecycle through reclamation and closure. Initial recommendations include:

- Conditioning subsidies, loans, and other incentives to only target mining companies with strong track records of environmental compliance at their other or past operations.
- Providing incentives only for mining companies that can demonstrate up-front secure financial assurance for full site reclamation and closure.
- Providing incentives only for mines in U.S. states that have strong mining environmental regulations and enforcement and compliance programs.
- For incentivized projects that require Federal permits or approvals, ensure regular environmental inspections occur for compliance with Federal permits and approvals.
- Requiring strong labor protections, including prevailing wage requirements, use of Project Labor Agreements and community hire on construction projects, union neutrality policies for employers, a ban on mandatory arbitration agreements, and requiring goods and materials to be made in the United States and shipped on U.S.-flag, U.S.-crewed vessels.

### **Increase Resilience by Strengthening U.S. Recycling**

While increased production of key minerals and materials is essential as battery production expands, recycling is already an important potential source of materials and has the potential to scale dramatically in the years ahead. National recycling policies will increase supply chain resilience in an environmentally responsible manner.

#### *Establish a National Recovery and Recycling Policy*

Recycling offers many benefits to critical materials sustainability. By developing a circular economy for advanced battery materials, the United States can capture this material back into the economy and reduce the need for virgin extraction while reducing greenhouse gas emissions. However, lithium battery recycling is not profitable in most scenarios when the steps of collection, sorting, transportation, and recycling are considered. Some in the industry believe that recycling will be more profitable when larger numbers of lithium ion batteries enter the recycling process, which is anticipated in the future with fleet electrification. The United States requires a comprehensive strategy to reach a sufficient lithium battery recycling rate to create material supply and support recycling profitability.

This national battery recycling strategy should include both executive and legislative actions. While specific details for a national strategy will need to be developed in coordination between a number of Federal agencies, executive actions could include grants, loans, and policies to encourage safe domestic recycling. Some examples of potential legislative actions could include tax incentives, a landfill ban, an extended producer responsibility mandate, or a recycling mandate. Such a national strategy will also mitigate safety risks posed by end-of-life lithium batteries during collection, storage, transportation, processing, recycling, and disposal. The strategy should consider varied approaches to increase collection and recycling for both waste consumer electronics which contain batteries, and for electric and hybrid vehicle batteries, which are managed through a different auto supply chain including scrap yards.

The United States should establish targeted incentives and strategic stockpiling for recycling and purification infrastructure and form a Battery Recovery and Recycling Task Force consisting of DOE, EPA, DOI, USGS, DOT, Commerce, and DOD.

- ***Targeted Incentives for Recycling:*** Congress should invest in lithium-ion battery recycling to accelerate scale-up of recycling, incentivize higher collection rates, and disincentivize landfilling. Recycling batteries is profitable in some cases, but the economics change depending on the composition of the battery, disassembly costs, transportation costs (to include packing efficiency), and recycling

process efficiency. Variable profit margins for lithium-ion battery recycling do not currently create a strong enough market pull to encourage widespread recycling rates. To increase process efficiency and scale in this area, incentives (e.g., a tax credit or rebate) and/or mandates targeted at recyclers and consumers could increase collection rates and support recycling scale-up. Additionally, existing programs like DOE's LPO should be leveraged to support building up domestic recycling capacity.

- **Battery Recovery and Recycling Task Force:** DOE, in its role as Chair of FCAB, should work with FCAB member agencies and others including EPA, DOI/USGS, DOT, Commerce, and DOD to assess the viability and cost of lithium battery recycling and chart a path for increased supply chain resilience through recycling. Initial findings can be captured in the 1-year Supply Chain Executive Order Report on the energy industrial base. Once a lithium battery has reached end of life, there are multiple governing agencies that have jurisdiction for this "waste" product. From DOT's role overseeing transportation of materials to EPA and DOI's role in siting and permitting of facilities, among other important activities, these agencies should work with DOE to capture a holistic view of the opportunity landscape and to coordinate action to support domestic recycling.
- **Ensure Recycling and Processing Meet Highest Environmental Standards:** The United States needs to ensure there are not adverse environmental impacts to increasing our domestic footprint in the battery supply chain, while recognizing the realities of waste treatment costs in processing and manufacturing. The first action in the recycling task force will be to understand waste considerations and update relevant metrics to ensure there are no local environmental impacts to creating domestic production in this area.

### 3. Promote Sustainable Domestic Battery Materials, Cell, and Pack Production

Production capacity of lithium-ion cells is expanding rapidly, mainly in Asia and Europe, and increasing over time. Cell manufacturers currently plan to increase production by over 300 percent in 2025 worldwide.<sup>188</sup> Yet, the United States is projected to only maintain an ~8 percent share within this cell manufacturing market. Cell and pack production also have high upfront costs. Public investments, through low cost credit, tax credits and other subsidies are important for scaling production in the United States at the rate needed to obtain market competitiveness and meet the President's climate commitments.

#### Catalyze Private Capital with Grants and Loans

##### *Enact New Federal Grant Programs to Catalyze Private Capital*

Congress should establish a cost-sharing grant program to support cell and pack manufacturing in the United States. This model helps entrepreneurs who do not have the ability to access tax credits in the short run while ensuring the taxpayer shares in the upside of the investment. Production of high-capacity battery cells in the United States is highly concentrated in a small number of companies. Establishing a grant program for cell manufacturing could create high value manufacturing jobs while increasing a more diverse and resilient industrial base.

The American Recovery and Reinvestment Act (ARRA) of 2009 included \$2 billion to establish matching cost share grants with industry to establish battery and electric drive manufacturing plants. 31 of the 38 manufacturing plants established through the ARRA are still in operation today. Public capital can also de-risk investment opportunities for private capital, crowding in investment in domestic facilities. All cost-

---

<sup>188</sup> "Lithium-Ion Battery Megafactory Assessment", Benchmark Mineral Intelligence, March 2021. Accessed April 12, 2021.



shared grant applications should be conditioned on an executable plan to sustain the facility without additional Federal financial assistance once operational.

### **Leverage the Advanced Technology Vehicle Management Loan Program**

The Advanced Technology Vehicle Management Loan Program (ATVM) should immediately issue a new call for proposals for projects that are seeking to start new facilities for cell and pack manufacturing in the United States. Federal loans and loan guarantees can catalyze projects to build capacity across domestic production, processing, manufacturing, and recycling technologies. LPO should leverage full statutory authority to finance key strategic areas of development and fill deficits in the domestic supply chain capacity.

### **Introduce Supportive Tax Credits**

#### *Re-vitalizing IRS 48C Manufacturing Tax Credits*

Congress should provide additional funding to the IRS 48C Manufacturing Tax Credit program. New funding for the program could include a set aside for coal communities, similar to Senators Manchin and Stabenow's legislative proposal.

ARRA included a tax credit for investments in manufacturing facilities for clean energy technologies. The qualifying manufacturing facilities included those producing a wide range of clean energy products, including energy storage systems for electric or hybrid vehicles. Potential recipient applications were evaluated using statutorily specified review criteria (including domestic job creation, impact on emissions, energy cost, etc.); then, the IRS formally accepted or rejected the taxpayer's application for 48C certification. The amount of the tax credit is 30 percent of qualified investment in advanced energy project property placed in service during a tax year. During ARRA implementation, the Section 48C advanced energy manufacturing tax credit was provided to 183 domestic clean energy manufacturing facilities valued at \$2.3 billion (which was the cap set in ARRA).

#### *Revive and Expand Section 1603 of American Recovery and Reinvestment Tax Act (ARRTA) program to support small manufacturers in the batteries, cells, and related material processing supply chain<sup>189</sup>*

Some U.S. cell manufacturers have argued that 48C only benefits manufacturers with a large tax base. The United States is highly dependent on large, multinational corporations for commercial scale manufacturing of lithium ion cells. While large multinationals would stand to gain from enhancements to section 48C, expanding section 1603 to include battery and cell manufacturing and material processing could support the development of smaller manufacturers by providing cash payments in lieu of ITCs.<sup>190</sup>

### **Leverage Federal Procurement and Financial Assistance**

#### *Strengthen U.S. Manufacturing Commitments in Federally-funded grants, cooperative agreements, and R&D contracts*

DOE should immediately strengthen, through the Determinations of Exceptional Circumstances under the Bayh-Dole Act and other legal means, domestic manufacturing requirements for grants, cooperative agreements and R&D contracts, including those related to lithium batteries. The determination should prioritize domestic manufacture and domestic impact for all applications of lithium batteries.

## **4. Invest in the people and innovations that are central to maintaining a competitive edge in the battery market**

The dramatic changes that have occurred in the last two decades in battery technology have opened the door for impactful growth in the U.S. economy at home and through access to markets abroad. Sustained public

---

<sup>189</sup> <https://home.treasury.gov/system/files/216/P-Status-overview-2018-03-01.pdf>

<sup>190</sup> The value of an award is equivalent to 30 percent of the projects total eligible cost basis in most cases. Section 1603 only included clean energy generation assets and did not include manufacturing of clean energy technologies.

investment over many decades has resulted in tangible market impact, with reduction in battery costs by approximately 85 percent.<sup>191</sup> Energy density of batteries has increased to meet consumer needs, enabling electric cars with a driving range above 300 miles. Furthermore, the cost reductions enabled by R&D in transportation has spurred a growing penetration of batteries for grid applications, with chemistries, invented using public R&D, now increasingly being deployed in both large storage installations and behind-the-meter storage solutions. Battery science and technology is of strategic importance for the overall energy landscape and U.S. economic competitiveness.

While securing a durable materials supply chain for batteries is important for supply chain resilience today, the public and private sectors can also collaborate to secure supply chains by innovating away from the minerals that are scarce or environmentally harmful in the long term. Research has begun to focus on reducing or eliminating the need for minerals like cobalt in batteries, and developing profitable business models for recycling “spent” batteries from the consumer electronics, transportation, and stationary energy sectors. There is an opportunity to invent the battery of the future, leading to the manufacture of “leapfrog” battery chemistries in the United States.

Public R&D will be insufficient to maintain a competitive battery market without the workforce to support domestic manufacturing of cells, packs, and end products. The education and expertise of the U.S. workforce is integral to our ability to compete and to create good-paying jobs in the United States. A well-paid labor force that can afford the EVs they build is also important to the economic durability of a robust clean energy economy. However, quality jobs will not materialize on their own. Labor standards, skills-based training, and comprehensive supports for workers moving from one sector to another is imperative. To successfully achieve these goals will require focused partnership between government, workers, industry, and local communities.

### **Invest in the Next Generation of Battery and EV Industry Workers**

#### *Develop the workforce needed for the growing battery manufacturing industry*

As the U.S. domestic battery industry grows, the need for a trained workforce across the supply chain will continue to increase. This may include jobs to extract and process raw materials, manufacture cell components and battery packs, manufacture EVs and charging infrastructure, and install stationary batteries and charging infrastructure. A lack of trained workers can impede rapid innovation and deployment, and lead to long term erosion of competitiveness. Wages that are too low can fail to attract or support skilled workers, slowing the process of debugging battery manufacturing processes (which are still nascent), and potentially causing safety hazards, since battery chemicals pose potential physical dangers. A “good jobs strategy” for batteries could aim to design jobs to take advantage of shop-floor workers’ knowledge to improve quality, safety, and uptime, akin to what is being explored by the German autoworkers’ union, IG Metall.

Federal programs should support training programs that leverage partnerships with car makers, unions, community colleges, and other key stakeholders to help train and retrain workers to meet this new market demand (e.g., retraining of powertrain workers to manufacture EV propulsion systems and other critical EV and battery components). Congress should fund apprenticeships and sector-based training programs that form partnerships, develop and scale training programs, and establish sector-specific career centers in battery and EV manufacturing. The Department of Labor will then make grants to consortia of workforce system entities, education providers, employers/industry groups, labor-management partnerships, community-based organizations, and unions. New appropriations should also be used to provide wraparound services and supports to help workers successfully complete the training programs.

Other investment priorities include: (1) working with universities that offer courses in batteries to expand the courses to include manufacturing; (2) providing financial support to universities to initiate a dedicated curriculum on battery manufacturing; (3) linking with research societies, such as the Electrochemical Society,

---

<sup>191</sup> (as of 2020) to \$143/kWh pack level.

to provide short courses in specific topics related to manufacturing; and (4) working with the National Labs to allow summer student internships to work at scale-up facilities.

*Include labor standards as a condition on production subsidies to empower workers and support the free and fair choice to organize*

The production incentives recommended in this report – tax credits, lending and grants – must ensure quality jobs with the free and fair choice to organize for workers. Funding should include prevailing wage requirements, similar to those included in ARRA. Other standards that should be included are: (1) mandated hiring percentages from registered apprenticeships and other labor or labor-management training programs, (2) project labor, community labor and local hire requirements, and (3) employer neutrality agreements.

### **Increase Funding for R&D to Expand Uptake and Reduce Supply Chain Vulnerabilities**

Smart R&D investments have the potential to restore U.S. leadership in batteries over time. For example, some EV companies have already announced plans to reduce or eliminate nickel and cobalt from their batteries, reducing supply chain vulnerabilities for those metals. New battery technologies have the potential to increase capacity and safety while reducing cost. The United States should support battery R&D to strengthen our technology leadership position and reduce supply chain vulnerabilities.

*Increase support for R&D to reduce battery cell costs, enhance performance, and reduce dependency on key critical materials*

Congress should appropriate new R&D funding, including to the U.S. National Laboratories, to invest in battery research that could reduce or eliminate the need for non-lithium critical minerals in battery technologies. Specific R&D focuses include: (1) reducing or eliminating critical or scarce materials needed for EV or stationary batteries, including cobalt and nickel; (2) accelerating battery technology advances including next generation lithium-ion and lithium-metal batteries, including solid state design; and (3) developing innovative methods and processes to profitably recover “spent” lithium batteries, reclaim key materials, and re-introduce those materials to the battery supply chain. Adding strong domestic manufacturing requirements to Federally-funded R&D programs combined with incentives to build here in the U.S will help establish a domestic manufacturing base for next generation technologies.

*Create a Manufacturing USA Institute for High-Capacity Batteries*

Congress should appropriate new funding for the Manufacturing USA program to create an institute focused on high-capacity batteries. Scaling from a lab prototype to the pilot scale is expensive and uncertain, sometimes taking as long as a decade. Manufacturing USA’s public-private model, collaborating with academic, industry and other stakeholders to test applications, train workers and de-risk investments, is important to helping new technologies move from lab-to-market. A new institute would support the development of next-generation processing and strengthen manufacturing and recycling technologies.

## ABBREVIATIONS

ACC – Advanced Chemistry Cell  
ARRA – American Recovery and Reinvestment Act  
ARRTA – American Recovery and Reinvestment Tax Act  
ASD(EI&E) – Assistant Secretary of Defense for Energy, Installations, and Environment  
ATVM – Advanced Technology Vehicle Management Loan Program  
CFIUS – Committee on Foreign Investment in the United States  
Commerce – Department of Commerce  
DFC – Development Finance Corporation  
DLA-SM – Defense Logistics Agency Strategic Materials  
DOD – Department of Defense  
DOE – Department of Energy  
DOI – Department of Interior  
DOT – Department of Transportation  
DPA – Defense Production Act  
DRC – Democratic Republic of the Congo  
EESL – Energy Efficiency Services Limited  
EPA – Environmental Protection Agency  
ERGI – Energy Resource Governance Initiative  
EU – European Union  
EV – Electric Vehicle  
FCAB – Federal Consortium for Advanced Batteries  
FEMP – Federal Energy Management Program  
FVEY – Five Eyes  
GDP – Gross Domestic Product  
GM – General Motors  
GML – General Mining Law  
GOI – Government of India  
GSA – General Services Administration  
GWh – Gigawatt-hour  
IBAS – Industrial Base Analysis and Sustainment  
IP – Intellectual property  
IRMA – Initiative for Responsible Mining Assurance  
IRS – Internal Revenue Service  
ISO – International Organization for Standardization  
ITC – Investment Tax Credit  
kWh – Kilowatt-hour  
LDV – light-duty vehicle  
LGES – LG Energy Solutions  
Lo-No – Low and No Emissions  
LPO – Loan Program Office  
MIIT – Ministry of Industry and Information Technology  
Mt – Million Metric Tonnes  
MWh – Megawatt-hour  
NDS – National Defense Stockpiling  
NEPA – National Environmental Policy Act  
NEW – New energy vehicle  
OEM – Original equipment manufacturer  
PLI – Production-linked incentives  
R&D – Research and development  
RD&D – Research, development, and demonstration  
Requirements Report – Strategic and Critical Materials Report to Congress on Stockpile Requirements  
SBIR – Small Business Innovative Research  
SEIA – Solar Energy Industry Association  
SKI – SK Innovation

SOC – State of charge  
SSE – Solid-state electrolyte  
STTR – Small Business Technology Transfer  
TC – Technical Committee  
TTCP – The Technical Cooperation Program  
USDA – Department of Agriculture  
USFS – United States Forest Service  
USGS – United States Geological Survey  
USMCA – United States-Mexico-Canada Agreement  
VTO – Vehicles Technologies Office  
WH/kg – Watt-hour per kilogram  
XUAR – Xinjiang Uyghur Autonomous Region  
ZEV – Zero emission vehicle



**REVIEW OF CRITICAL MINERALS AND MATERIALS**

**DEPARTMENT OF DEFENSE**

## EXECUTIVE SUMMARY

Strategic and critical materials are the building blocks of a thriving economy and a strong national defense. They can be found in nearly every electronic device, from personal computers to home appliances, and they support high value-added manufacturing and high-wage jobs, in sectors such as automotive and aerospace.

The global supply chain that delivers strategic and critical materials is nominally distributed, diverse, and embraces market competition. Upon closer inspection though, these supply chains are at serious risk of disruption—from natural disasters or *force majeure* events, for example—and are rife with political intervention and distortionary trade practices, including the use of forced labor. Contrary to a common belief, this risk is more than a military vulnerability; it impacts the entire U.S. economy and our values.

Furthermore, the need for strategic and critical materials is likely to intensify, in so far as these materials also enhance or enable the performance of many environmentally friendly “green” technologies, such as electric vehicles, wind turbines, and advanced batteries. A recent report by the International Energy Agency (IEA) notes: “A typical electric car requires six times the mineral inputs of a conventional car and an onshore wind plant requires nine times more mineral resources than a gas-fired plant. Since 2010, the average amount of minerals needed for a new unit of power generation has increased by 50 percent as the share of renewables in new investment has risen.”<sup>1</sup>

In brief, the challenges and opportunities in strategic and critical material supply chains are emblematic of the intense geopolitical competition of the 21<sup>st</sup> century. Its complexity, global scope, and cross-cutting nature compel a whole-of-government approach by the United States, as well as close collaboration with our allies, partners, and the private and non-profit sectors.

To that end, this is an interagency assessment, for which the Department of Defense served as the lead. Nearly every agency of the U.S. Government has a unique capability that can be brought to bear to increase the sustainability of strategic and critical materials supply chains. This is illustrated in prior studies under Executive Order (E.O.) 13817 and E.O. 13953, and this foundation and the civilian-centric nature of the challenge have infused the entirety of this assessment under E.O. 14017, *America’s Supply Chains*.

To address defense and essential civilian supply chain risk for strategic and critical materials, the President designated the Secretary of Defense as the National Defense Stockpile (NDS) Manager. Congress established this position, and the National Defense Stockpile program, in the summer of 1939, with conflict in the Pacific already underway and the threat of a European conflict looming. Later, throughout the Cold War, the NDS program was a cornerstone of the U.S. Government’s mobilization enterprise, alongside robust investment programs led by multiple non-defense agencies under the Defense Production Act (DPA) of 1950.

The end of the Cold War in 1991, three decades ago, marked the beginning of a global reorientation of supply chains for strategic and critical materials. Sources of supply, previously locked behind the Communist “Iron Curtain,” became available to Western manufacturers in significant quantities. The economy of China, which at that time was only 6 percent of the size of the U.S. economy,

---

<sup>1</sup> International Energy Agency, *The Role of Critical Minerals in Clean Energy Transitions* (May 2021), <https://iea.org/reports/the-role-of-critical-minerals-in-clean-energy-transitions>



began its meteoric rise. Trade liberalization and global, just-in-time supply chains became the order of the day.

Economic efficiency took priority over diversity and sustainability of supply—made manifest in the slow erosion of manufacturing capabilities throughout the United States and many other nations. In addition, as the point of consumption drifted farther and farther from the point of production, U.S. manufacturers increasingly lost visibility into the risk accumulating in their supply chains. Their suppliers of strategic and critical materials, and even the workforce skills necessary to produce and process those materials into value-added goods, became increasingly concentrated offshore. In such opaque conditions, the exploitation of forced labor and a disregard for environmental emissions and workforce health and safety could thrive.

In parallel, the impetus for national mobilization programs fell by the wayside. The Federal Government reaped a multi-billion dollar “peace dividend” from the sale of N D S materials, and core capabilities at non-defense agencies to study, characterize and mitigate risk in the strategic and critical materials sector atrophied.

Today, at the beginning of the third decade of the 21<sup>st</sup> century, a new industrial era of low-carbon and increasingly energy efficient products is converging with autonomous and Internet-of-Things devices, which may lead to massive gains in productivity and economic growth. If the United States wants to capture the full benefits of this new era, we must also look to the sustainability of our strategic and critical materials supply chains. The Department of Defense can play an important role, but the Department cannot carry-out this task alone. This is a task for the Nation.

The U.S. Government, collectively, has examined the risk in strategic and critical materials supply chains for decades. Now is the time for decisive, comprehensive action by the Biden-Harris Administration, by the Congress, and by stakeholders from industry and non-governmental organizations to support sustainable production and conservation of strategic and critical materials.

## **INTRODUCTION**

Strategic and critical materials and their supply chains are the bedrock of value-added manufacturing and the development, production, delivery, and sustainment of essential services, such as telecommunications and computing, food and agriculture, finance, healthcare, education, transportation, and public safety.

In civilian sectors of the U.S. economy, strategic and critical materials and their supply chains are essential to countless manufactured goods, ranging from personal electronics and consumables for fuel, food, and medical supplies, to home construction and sustaining the nation's critical infrastructure. Reliable access to strategic and critical materials strengthens the global economy and helps improve the quality of life.

In the defense industrial base, strategic and critical materials ensure that U.S. Armed Forces and those of our allies can conduct and sustain operations, while expanding the output and development of military items to maintain technical dominance over adversaries. Without these materials, history shows that industrialized nations have been compelled to make performance trade-offs and suboptimal capital allocations, which contributed to their defeat on the battlefield.

Though domestic strategic and critical materials production represents only a small fraction of total U.S. employment and Gross Domestic Product (GDP), downstream manufacturing and related service sectors support substantially greater economic output and jobs. For example, annual domestic mining activities, valued at less than \$100 billion, enable more than \$3 trillion in domestic value-added industry sectors, out of a

\$20 trillion economy.<sup>2</sup> This contribution to downstream manufacturing and service sectors is indicative of the derivative value of strategic and critical materials.

### **Strategic and Critical Materials Defined<sup>3</sup>**

This collaborative work builds upon recurring assessments of strategic and critical materials across the interagency, such as recent work led by the Departments of Commerce and the Interior under E.O. 13817, A Federal Strategy To Ensure Secure and Reliable Supplies of Critical Minerals, and E.O. 13953, Addressing the Threat to Domestic Supply Chain from Reliance on Critical Minerals from Foreign Adversaries and Supporting the Domestic Mining and Processing Industries. As directed by E.O. 14017, America's Supply Chains, the Department of Defense (DoD) assessed the resilience of supply chains for "strategic and critical materials" in its role as the NDS Manager,<sup>4</sup> with support from the interagency.

Though similar to "critical minerals,"<sup>5</sup> the definition of strategic and critical materials for the purposes of the Strategic and Critical Materials Stockpiling Act of 1979 (50 U.S.C. 98 *et seq.*) (the Stockpiling Act) encompasses any materials that are:

Needed to supply the military, industrial, and essential civilian needs of the United States during a national emergency, and

Not found or produced in the United States in sufficient quantities to meet such need.

Functionally, the analytical framework for "critical minerals" and "strategic and critical materials" overlap but with two fundamental differences. First, the organizing principle for critical minerals is mining, mineral processing, and related metal products or compounds. In contrast, "strategic and critical materials" is broader, including downstream products and materials produced outside of mining activities (e.g., carbon fibers). Second, the NDS Manager function presupposes a national emergency scenario or a more stressful mobilization scenario.

In light of these differences, recurring assessments of critical minerals under E.O. 13817 have identified 35 commodities and minerals as "critical minerals."<sup>6</sup> DoD, as the NDS Manager, monitors more than 250 unique strategic and critical materials; some findings of this modeling are in the *Risk Factors at the Level of Armed Conflict* section of this report. Thus, this report subsumes issues in critical minerals supply chains into the broader discussion of strategic and critical materials.

Notwithstanding DoD's assessment framework, which is emergency-driven, this report's observations, strategy, and recommendations represent the consolidated views of the interagency

---

<sup>2</sup> U.S. Geological Survey, *Mineral Commodity Summaries 2022* (January 29, 2021), <https://pubs.usgs.gov/periodicals/mcs2021/mcs2021.pdf>.

<sup>3</sup> **Note:** Significant quantities of strategic and critical materials may be found on the seabed, but the industry to extract these resources remains nascent, given both technical challenges of mining in the marine environment and the potential for significant environmental harm. On the other hand, substantial portions of mineral exploration leases are held by foreign sources, providing not only a potential supply benefit, but also dual-use technology development associated with unmanned undersea vessels and hydrographic mapping. Though seabed resources may provide a significant future source of strategic and critical materials, they are not covered by this report.

<sup>4</sup> As appointed in the Strategic and Critical Materials Stock Piling Act of 1979 (50 U.S.C. 98 *et seq.*), specifically 50 U.S.C. 98h-7.

<sup>5</sup> As defined in E.O. 13817, a critical mineral is "a mineral identified by the Secretary of the Interior [pursuant to the E.O.] to be (i) a non-fuel mineral or mineral material essential to the economic and national security of the United States, (ii) the supply chain of which is vulnerable to disruption, and (iii) that serves an essential function in the manufacturing of a product, the absence of which would have significant consequences for our economy or our national security." 82 Fed. Reg. 60835. 2017, <https://federalregister.gov/documents/2017/12/26/2017-27899/a-federal-strategy-to-ensure-secure-and-reliable-supplies-of-critical-minerals>

<sup>6</sup> Department of the Interior, "Final List of Critical Minerals 2018," 83 Fed. Reg. 23295; 2018, <https://federalregister.gov/documents/2018/05/18/2018-10667/final-list-of-critical-minerals-2018>.

and provide a concise whole-of-government approach to the strategic and critical materials sector. This approach also mirrors DoD's longstanding results from macroeconomic modeling of the sector under national emergency scenarios. For more than a decade, DoD has consistently found that the *essential civilian industry* would bear the preponderance of harm from a disruption of strategic and critical materials supply.

## MAPPING THE SUPPLY CHAIN

### Description of Strategic and Critical Materials Production

#### Overview

The supply chain for strategic and critical materials generally begins with mining the raw material. Open pit or underground mining techniques are used to extract ore, which is then crushed and ground into a size that enables its separation into metal oxides and/or other chemical forms (e.g., halides). Some strategic and critical materials, such as lithium, may be extracted by in-situ mining and extraction techniques. After this beneficiation or concentration process, the material is smelted or refined using electrolytic or pyrometallurgical processes to produce a purified powder, metal, or other material in a semi-final form. Final steps include further refining, manufacturing, cutting, and polishing into a semi-finished or finished product with unique material properties depending on the material's final use. Additional detail on these stages are described below.

- **Beneficiation** consists of physical processing techniques in which mined ore is sorted and crushed into smaller particle sizes for subsequent downstream processing operations. Beneficiation processes may be as simple as hand-picking and sorting to mechanical or chemical processes such as froth flotation, in which air bubbles are injected into an ore-chemical mixture to allow foam-carrying ore particles to be separated from waste rock. In rare earth and other mineral processing operations, the result of beneficiation often is called a "mineral concentrate" or a "chemical concentrate" with a total rare earth oxide (TREO) content ranging from 40 percent to 60 percent.
- **Hydrometallurgy** consists of multiple liquid-to-liquid processing operations that further remove trace element impurities and separate individual strategic and critical materials from one another. Common hydrometallurgical processes include ion exchange and solvent extraction, with the former dating to World War II and the latter developed in the 1970s. Industry and the U.S. Government have sponsored significant research and development (R&D) in this area to minimize environmental impact and increase process efficiency, given the significant quantities of chemical reagents and potential waste-water discharges associated with hydrometallurgical operations. In a rare earth processing operation, the result of hydrometallurgical processes generally is in the form of a rare earth oxide, with a TREO content ranging from not less than 99 percent (2N) to 99.999 percent (5N).
- **Pyrometallurgy and Electrolysis** consists of multiple processing operations which use heat or electricity to separate the oxide, halide, or other non-metal component of a metal salt from a resulting hydrometallurgical or beneficiation process. There are key tradeoffs associated with both processing routes. Electrolysis can have higher production rates since it runs continuously, but due to its continuous nature, it can be more costly in the long run when an electrolytic process is shut down and re-started, rather than simply absorb its short-run operating losses. This is a significant challenge in the aluminum sector. On the other hand, pyrometallurgical processes, like metal reduction or distillation, generally are batch-type operations, but they can produce significantly higher purity metal products. The resulting metal products from either pyrometallurgy or electrolysis also may undergo subsequent purification steps, such as zone refining, to further improve metal purity. Metal products resulting from this processing step or subsequent purification can range from 2N to much greater than 5N.

- **Finishing** consists of dozens of different downstream production processes, which lead a metal product towards its specific end-use. “Finishing” in this context incorporates numerous subsequent production steps such as melting and alloying with other materials, casting, milling of alloys to fine powders, sintering and pressing of metal powders, and machining of the consolidated metal products to the desired form.

Each step in this production chain — beneficiation, hydrometallurgy, electrolysis and pyrometallurgy, and finishing — is a distinct technical discipline that can require years of practice to perfect. Once those workforce skills are lost, reconstituting them is extremely expensive, both in terms of higher costs and inefficient production, and may require importing technical expertise from foreign sources to catch-up to global production and quality benchmarks. Ultimately, each strategic and critical material has a unique version of the above generalized process description, with further examples in Appendix A.<sup>7</sup>

## Material Flow Analyses

Material flow analyses are an important tool to cross-walk the above processing steps to global production and demand for strategic and critical materials from primary sources (e.g., mining) as well as the in-process and post-consumer recycling of strategic and critical materials. Analysis of potential supply shortages, supply diversification and security, resource efficiency, and the potential for future recycling is facilitated by such studies. The flow of materials through the various stages of a supply chain can be illustrated using a Sankey diagram, an example of which is shown in Figure 15 for tantalum.<sup>8</sup>

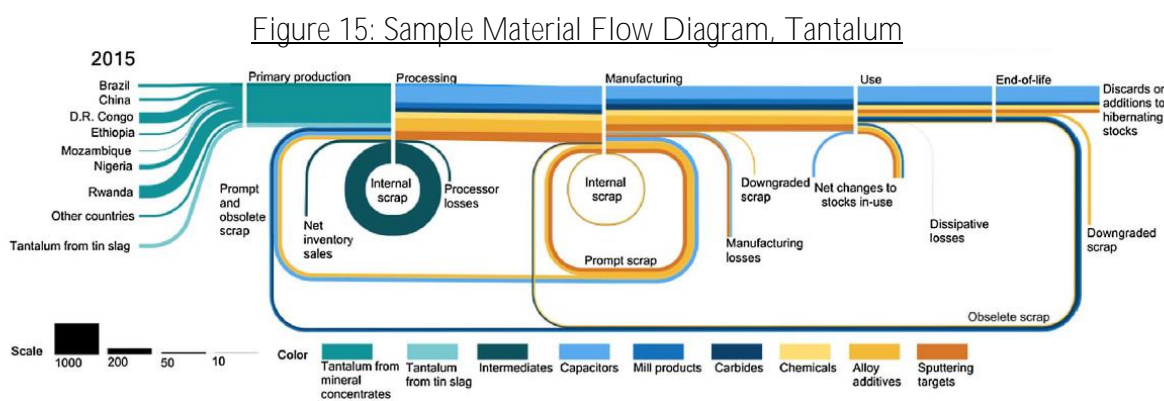

Tantalum is a strategic and critical material for which the United States meets 100 percent of its mineral consumption needs from foreign sources. The most significant demand driver for tantalum is in the electronics market, in the form of tantalum capacitor and wire products, but DoD has important tantalum requirements in the form of commercial and dual-use goods (e.g., aerospace alloys and electronics), as well as defense-unique items (e.g., explosively formed projectiles). Tantalum is of sufficient importance to defense supply chains that Congress implemented sourcing restrictions on this material and others through 10 U.S.C. 2533c.

Material flow analyses are also an important tool to identify outsized foreign reliance and vertical integration in supply chains. The neodymium-iron-boron (NdFeB) magnet supply chain is an example of a strategic and critical materials supply chain where one country is able to maintain vertical capabilities throughout the supply chain, while multiple other countries operate at only select tiers (see Figure 2). These examples show that material flows can potentially be relatively concentrated within a country, or they can follow a circuitous

<sup>7</sup> All appendices to this document are classified as UNCLASSIFIED//CONTROLLED UNCLASSIFIED INFORMATION.

<sup>8</sup> N.T. Nassar, “Shifts and trends in global anthropogenic stocks and flow of tantalum,” *Resources, Conservation and Recycling*, Vol. 124 (October 2017), pp 233-250, <https://sciencedirect.com/science/article/abs/pii/S0921344917301556?via=percent3Dihub>

global path. Though only China has all essential supply chain tiers, at least some nominal capacity exists for each tier in a combination of countries outside China.

Figure 2: Global Locations for NdFeB Supply Chain Tiers<sup>9</sup>

Country	Mining	Mixed Compounds	Separation to REO <sup>10</sup>		Oxide to Metal	Magnet Alloys	NdFeB Sintered Magnets
			LREE <sup>11</sup>	HREE <sup>12</sup>			
Australia	•	PILOT					
Burma (Myanmar)	•	•					
Burundi	•						
China	•	•	•	•	•	•	•
Estonia			•				
Germany							•
France			•	•			
Malaysia		•	•				
Russia	•	•	•				
India	•	•	•				
Japan				•	•	•	•
Kazakhstan			IDLE				
United States	•	**	**	**	IDLE	IDLE	**
United Kingdom					•	•	
Vietnam					•	•	•
Other	•	•	•		•	•	•

### In-Process and Post-Consumer Recycling

The National Minerals Information Center at the U.S. Geological Survey collects information on recycling for various mineral commodities. Recycling rates for major metals often are very high; steel recycling rates typically exceed 80 percent annually, satisfying a substantial proportion of annual consumption. The data surrounding recycling rates for strategic and critical materials, however, is highly variable and relies on voluntary submissions of business proprietary information. In some cases, little or no data is available to the U.S. Government, though at the opposite extreme, some strategic and critical materials are derived exclusively from post-consumer recycling processes, such as certain fire-suppression and refrigerant gases. When available, data related to secondary supply is incorporated into U.S. Government supply and demand forecasts for strategic and critical materials, within Appendix A and Appendix B.

Recycling of rare earth permanent magnets is an area of increasing activity among domestic entities, including one company sponsored by the DoD under a Defense Production Act (DPA) Title III award and an active area of research funded by the Department of Energy. Interest in recycling lithium ion batteries also is developing rapidly, supported by research funding from the Department of Energy and an expectation of increased supply as the first generation of hybrid-electric and full electric vehicles become available for recycling. Though increasing recycling rates for strategic and critical materials is advantageous, recycling alone is typically inadequate to supply the volumes of material required for domestic consumption. Even if 100 percent recycling rates were achieved for a particular supply chain, increasing demand necessitates primary production. Copper, for example, has very high recycling rates but recycled copper currently supplies

<sup>9</sup> \*\* Represents supply chain tiers in which the U.S. Government is currently working with industry to re-establish capacity.

<sup>10</sup> Rare Earth Oxide.

<sup>11</sup> Light Rare Earth Element.

<sup>12</sup> Heavy Rare Earth Element.

less than 40 percent of annual U.S. consumption, the balance of which is made up of primary mined ore and processed metal.

## Domestic Sources of Strategic and Critical Materials

### *Development Timelines for Domestic Operations*

As a series of complex extraction, chemical, and refining operations, establishing strategic and critical material production is an extremely lengthy process. Independent of permitting activities, a reasonable industry benchmark for the development of a mineral-based strategic and critical materials project is not less than ten years.

Figure 3: Overview of Development Timeline for Greenfield Strategic & Critical Materials Projects<sup>13</sup>

1. Establish Resource (2-5 years)	2. Mineralogy (1-3 years)	3. Scoping Studies (1-3 years)	4. Beneficiation/Extraction/ Separation Pilot Plant (2-10 years)
Establish resource that meets local stock market regulations	Identification of minerals bearing the target product	Inferred resource Bench scale process Baseline environmental study	Demonstrate viability Generate data for feasibility studies Samples sent for customer evaluation Generate data for environmental studies
5. Environmental Assessments & Approvals (Variable)	6. Letters of Intent (Concomitant with 1-5 years)	7. Feasibility Study & Funding (2-4 years)	8. Construction & Startup (2-3 years)
Public review	Integrate operations with customer supply chains	± 15 percent accuracy for capital expenditure and operating expenditure estimates	Sophisticated engineering, procurement and construction studies De-bugging/Optimizing operations

Moreover, it is quite common for most companies to fail to reach the end of this development process, simply due to the long project development time without cash flows to offset expenses and the technical challenges associated with large, complex project financing for materials production. For example, at the peak of industry and market interest in the rare earth sector in early 2011, the *Technology Metals Research* “Advanced Rare-Earths Project Index” tracked approximately 275 rare earth projects under development by 180 publicly-traded companies in 30 countries, excluding projects in China, Russia, and India.<sup>14</sup> As of April 2021, only two of these projects entered full-scale production, and two others remain in pilot-plant production—a combined success rate of 1.5 percent over the past decade.

## U.S. Production and Net Import Reliance

The United States has always relied on imports of strategic and critical materials to meet its public and private sector needs, even in wartime. Over the last sixty years<sup>15</sup> and especially since the end of the Cold War, U.S. production has decreased and our net import reliance has grown across multiple strategic and critical materials. Net import reliance is defined as the amount of imported material (including changes in existing stocks) minus exports as a percentage of domestic consumption. Though encompassing all strategic and critical materials, the number of non-fuel mineral commodities for which the United States is at least 25 percent import reliant has grown from 21 products to 58 products from 1954 to the present, with current net import reliance shown in Figure 4.

<sup>13</sup> Derived from Dudley Kingsnorth, *Rare Earths: Reducing Our Dependence Upon China*, Metal-Pages Rare Earths Conference (September 2011); note that the development timeline for recycling projects or adding new processing circuits to existing primary production facilities may have a significantly shorter (1-3 years) development cycle.

<sup>14</sup> Gareth Hatch, “Introducing the TMR Advanced Rare-Earth Projects Index,” *Futures Magazine* (January 6, 2011), <http://m.futuresmag.com/2011/01/06/introducing-tmr-advanced-rare-earth-projects-index>

<sup>15</sup> United States Geological Survey, *Comparison of U.S. Net Import Reliance for non-fuel mineral commodities – A 60-Year Retrospective (1954-1984-2014)*, <https://pubs.usgs.gov/fs/2015/3082/fs20153082.pdf>

Figure 4: U.S. Net Import Reliance (2020)<sup>16</sup>

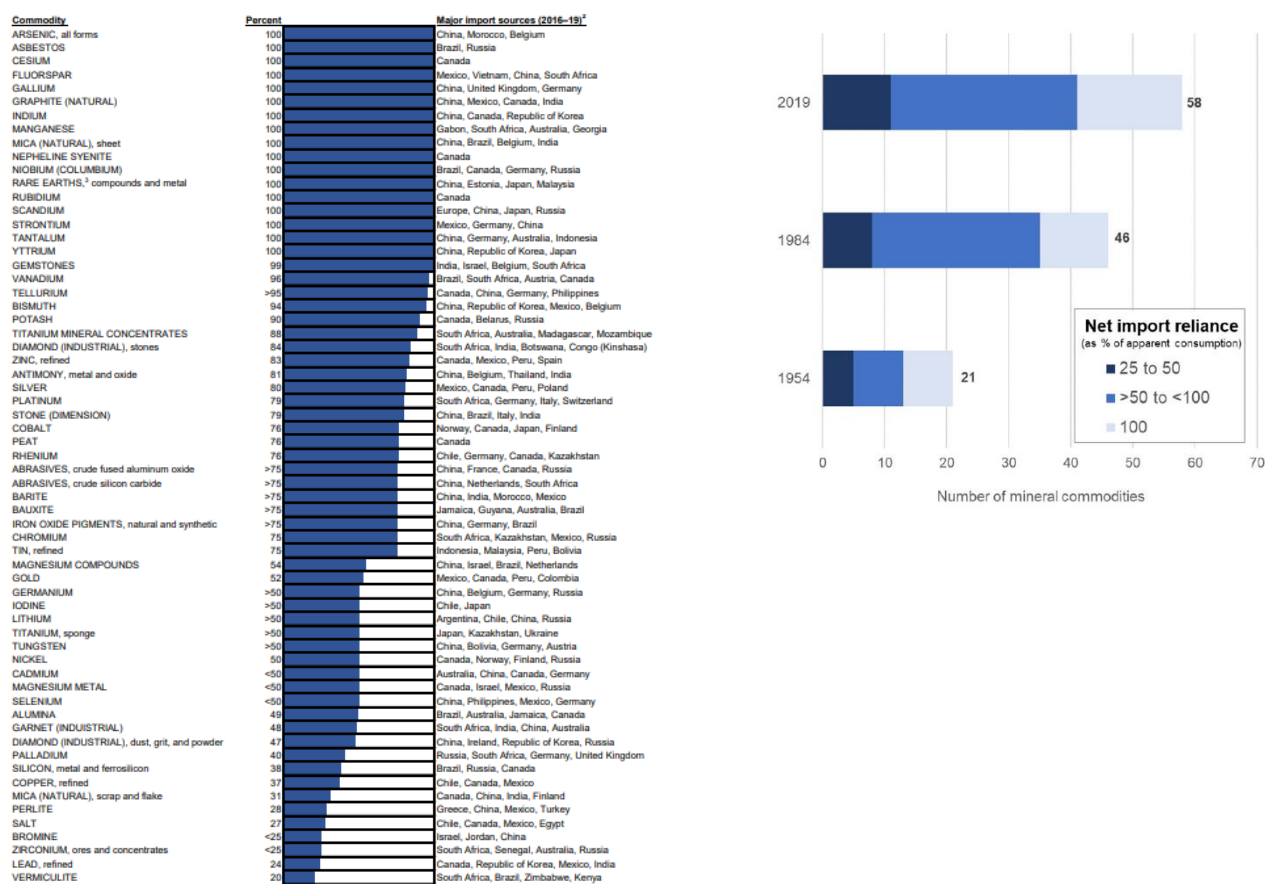

<sup>1</sup>Not all mineral commodities covered in this publication are listed here. Those not shown include mineral commodities for which the United States is a net exporter (boron; clays; diatomite; helium; iron and steel scrap; iron ore; kyanite; molybdenum concentrates; sand and gravel; industrial; soda ash; titanium dioxide pigment; wollastonite; zeolites; and zinc concentrates) or less than 20% net import reliant (abrasives; metallic aluminum; beryllium; cement; feldspar; gypsum; iron and steel; iron and steel slag; lime; nitrogen (fixed)-ammonia; phosphate rock; pumice; sand and gravel; construction; stone, crushed; sulfur; and talc and pyrophyllite). For some mineral commodities (hafnium; mercury; quartz crystal, industrial; thallium; and thorium), not enough information is available to calculate the exact percentage of import reliance.

<sup>2</sup>Listed in descending order of import share.

<sup>3</sup>Data include lanthanides.

This evaluation of net import reliance is constrained to observable U.S. and international trade statistics for direct demand. Direct demand records imports of strategic and critical materials, as “materials,” for use by domestic manufacturing operations. However, certain sectors of the industrial base may have so atrophied that no U.S. manufacturer is purchasing said strategic and critical materials. At this point, U.S. net import reliance for materials is captured by an evaluation of embedded demand— imports of intermediate goods and value-added finished products that already contain strategic and critical materials.

An excellent example of embedded demand versus direct demand is the rare earth market. U.S. mine production of rare earth elements was approximately 28,000 metric tons in 2019, with direct U.S. imports of approximately 13,000 metric tons (rare earth oxide equivalent basis). U.S. production and imports, respectively, constitute about 12 percent and 5 percent of global rare earth production.<sup>17</sup> The bulk of U.S. production is in the form of mineral/chemical concentrates and some light rare earth oxides, and similarly,

<sup>16</sup> U.S. Geological Survey, *Mineral Commodity Summaries 2021* (January 29, 2021), <https://pubs.usgs.gov/periodicals/mcs2021/mcs2021.pdf>

<sup>17</sup> U.S. Geological Survey, *Mineral Commodity Summaries – Rare Earths* (January 2021), <https://pubs.usgs.gov/periodicals/mcs2021/mcs2021-rare-earths.pdf>

the preponderance of direct imports (by weight) are in the form of light rare earth compounds, principally lanthanum, to support the domestic petrochemical industry.

The United States imports substantially greater quantities of rare earth elements in value-added products, such as those listed in Figure . Implicit in this trade phenomenon is the gradual decline in value-creation, innovation, research, and human capital development (see Appendix A for more detail).

Figure 5: Downstream Applications for Rare Earth Elements

Element		Major Applications
LREE	Lanthanum	Fluid catalytic cracking for petroleum refining, nickel metal hydride (NiMH) batteries, metallurgical applications, glass and polishing ceramics lighting.
	Cerium	Automobile catalysts and additive, FCC additives, catalysts, metallurgy, polishing, powders and glass and others such as fertilizer, paint drying, and a stabilizer in plastics. Applications often overlap with lanthanum.
	Praseodymium	NdFeB, metallurgical applications, pigments, batteries, and catalysts.
	Neodymium	NdFeB magnets, glass and ceramics applications such as ceramic capacitors, metallurgical applications such as a minor alloying element for iron and steel alloys and magnesium alloys, luminophores, and other applications such as NiMH batteries, catalysts, and lasers. NdFeB magnets are used in products such as computer hard disk drives, magnetic resonance imaging (MRI), precision guided munitions, automotive motors, wind turbines, and loudspeakers.
	Samarium	Samarium cobalt permanent magnets, which are used in electronics (including military systems), automobiles, aerospace, pumps, and medical devices. Other applications include infrared absorption glass, optical glass, fuel cells, for nuclear applications, and capacitors for microwave frequencies.
HREE	Europium	Phosphors and luminophores, which are used in TV and computer screens, compact fluorescent lighting, light emitting diodes (LEDs), and sensors. Other applications include nuclear and medical applications and for some specialty alloys and lasers.
	Gadolinium	Metallurgical applications such as magnetic refrigeration, magnesium alloys, and specialty alloys. Also used in small amounts for samarium cobalt magnets. Other uses include MRI contrasting agent and phosphors for dental and medical applications.
	Terbium	Phosphors (green) for displays, LEDs, and in medical applications, in permanent magnets, and for other applications such as high-temperature fuel cells, lasers, and magnetostrictive alloys for solid-state transducers and actuators used in sonar and other dual use technologies.
	Dysprosium	Neodymium iron boron permanent magnets in which it makes up generally about 0.8 percent to 1.2 percent by weight of the magnet; magnetostrictive alloys.
	Holmium	Magnets, magnetostrictive alloys for sensors and actuators.
	Erbium	Nearly all erbium is used in polishing and in highly specialized glass lens applications and fiber optics.
	Thulium	Portable X-ray devices, research, and a dopant in solid-state lasers and highly specialized fiber optics.
	Ytterbium	Metallurgical applications for rare earth magnesium alloys and specialty aluminum alloys.
	Lutetium	Used in medical equipment and small quantities in phosphors.
Yttrium	Yttrium-stabilized zirconia (YSZ) ceramics, phosphors, and metallurgy. Some specific applications include thermal barrier coatings, lasers, oxygen sensors, and solid electrolytes for solid oxide fuel cells (SOFCs). Phosphors, optical glasses, rotary-wing aircraft alloys, and nickel-metal hydride (NiMH) batteries.	
	Scandium	Solid oxide fuel cells (SOFC), aluminum alloys for aerospace and sporting goods, scandium-sodium lamps for outdoor venues, laser, optoelectronic materials, LEDs.



## U.S. and Allied<sup>18</sup> Production Base for Strategic and Critical Materials

### *The Domestic Production Base*

Working in close collaboration with the private sector and multiple interagency partners, DoD has mapped multiple upstream tiers of the strategic and critical materials sector. This digital mapping tool, called the Strategic Materials Assessment and Risk Topography (SMART), includes key domestic and international nodes within strategic and critical material supply chains, the output and capacity for primary extraction and downstream processing at these sites, as well as the relationships amongst these industry nodes and downstream manufacturing sectors. DoD constantly updates SMART with data-feeds from across the U.S. Government, open sources, and other business proprietary data in an effort to understand sub-tier supply chain vulnerabilities in the strategic and critical materials sector.

Outputs from SMART have been included in multiple reports to Congress pursuant to 50 U.S.C. 98h-5, and DoD continues to use SMART, along with several other industrial base mapping tools, to identify and proactively mitigate potential vulnerabilities in the industrial base from the spread of COVID-19.

For DoD's modeling of strategic and critical materials vulnerabilities (see Risk Factors at the Level of Armed Conflict and Appendix A), DoD used SMART to track 189 domestic facilities that currently produce or could produce the strategic and critical materials within the mitigation timeframe<sup>19</sup> of those models. Given the significant shortfalls identified in this analysis, the U.S. industrial base has significant latent capacity that could support U.S. essential civilian and defense requirements given appropriate market incentives. The precise capabilities at the facilities indicated in Figure 6 are not labeled for security purposes, but these facilities represent a variety of mining, processing, and advanced materials capabilities.

Figure 6: Domestic Active and Potential Production Sites for Strategic & Critical Materials

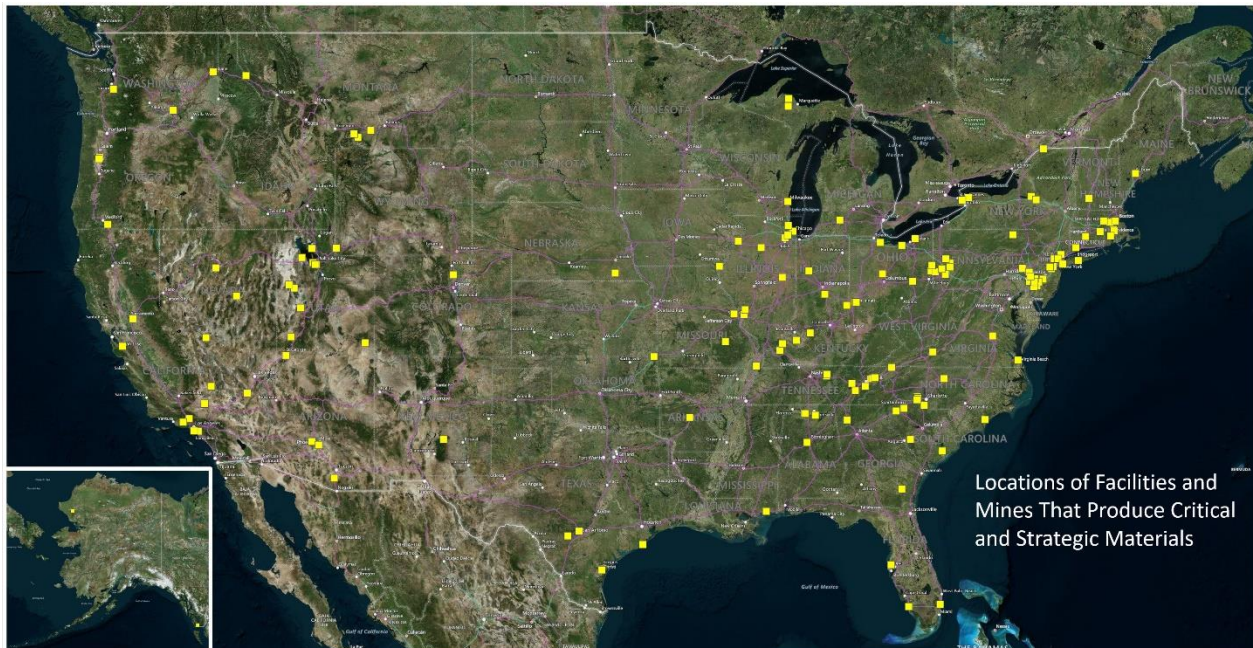

<sup>18</sup> **Note:** The United States has multiple allies and security and trading partners that play a critical role in the strategic and critical materials industrial base. This section provides an overview of only select partners in the interest of brevity.

<sup>19</sup> 50 U.S.C. 98h-5 specifies a “base” conflict period, followed by a three-year period for the replenishment or replacement of all munitions, combat support items, and weapon systems and related essential civilian and industrial requirements after the conflict period.

## GLOBAL FOOTPRINT

### Allies and Partners

The United States maintains robust relationships with its allies and partners to support the deeper integration of defense and essential civilian supply chains. This engagement also is a core recommendation of the report delivered pursuant to E.O. 13817, A Federal Strategy to Ensure Secure and Reliable Supplies of Critical Minerals. Under this strategy, the United States entered into broad interagency critical minerals collaboration engagements coordinated via diplomatic channels with Canada and Australia, and other countries have requested similar agreements with the U.S. Government. Unfortunately, the onset of the COVID-19 pandemic severely disrupted the interagency's ability to advance these action plans.<sup>20</sup>

### CANADA

Canada is a member of the National Technology and Industrial Base (NTIB) under 10 U.S.C. 2500. Canadian companies and persons are the only non-U.S. entities and persons who are considered a "domestic source" for the purposes of the DPA (50 U.S.C. 4500 et seq.). Both of these factors reflect the deeply integrated nature of the U.S. and Canadian economies and the very strong security relationship between the United States and Canada.

This economic integration leads to Canada being the second-largest import source for those strategic and critical materials for which the United States has net import reliance greater than 50 percent.<sup>21</sup> Canadian mining and material processing companies export a variety of strategic and critical materials to the United States, including high-purity aluminum and gallium. The latter, gallium, is gaining more importance due to new Internet-of-Things and semiconductor applications, as well as longstanding applications in integrated circuits, laser diodes, LEDs, solar cells, radar missile defense, and infrared imaging.

Trade in mineral-based strategic and critical materials between the U.S. and Canada exceeds \$76 billion, and Canada is a global hub for mining project finance, including the risk finance that supports junior mining companies exploring for strategic and critical materials and developing the next generation of projects. Canada has substantial resource potential in existing operations and planned projects that could support U.S. needs for cobalt, tantalum, antimony, and twenty additional strategic and critical materials.

---

<sup>20</sup> A discussion of the impact of COVID-19 pandemic on DoD activities in the strategic and critical materials sector is described in U.S. Department of Defense, *Fiscal Year 2020 Industrial Capabilities Report to Congress* (January 2021), [https://www.businessdefense.gov/Portals/51/USA002573-20percent20ICR\\_2020\\_Web.pdf?ver=o3D76uGwxcg0n0Yxvd5k-Qpercent3dpercent3d](https://www.businessdefense.gov/Portals/51/USA002573-20percent20ICR_2020_Web.pdf?ver=o3D76uGwxcg0n0Yxvd5k-Qpercent3dpercent3d)

<sup>21</sup> U.S. Geological Survey, "*Mineral Commodity Summaries 2021*" (January 29, 2021), <https://pubs.usgs.gov/periodicals/mcs2021/mcs2021.pdf>

Figure 7: Canadian Strategic and Critical Material Deposits<sup>22</sup>

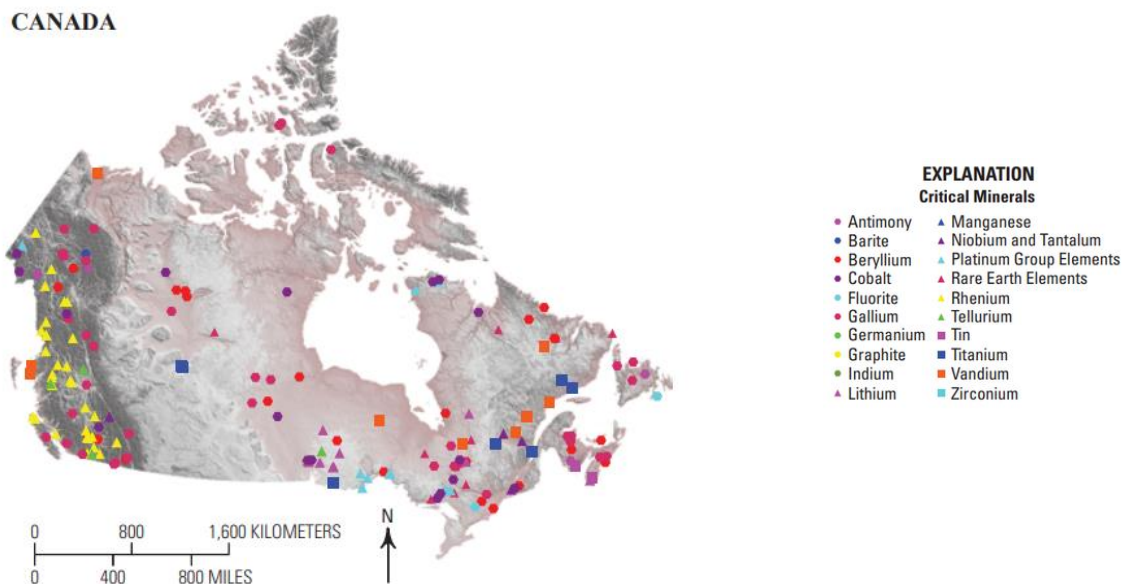

## AUSTRALIA

Australia also is a member of the NTIB. Although Australian entities are not considered a domestic source for the purposes of the DPA, Australian companies have forged several important partnerships with U.S. companies to participate in contracting opportunities related to strategic and critical materials. Key examples of this work include joint ventures related to the processing of light and heavy rare earth oxides through the Industrial Base Analysis & Sustainment (IBAS) program and Title III of the DPA.

As a mineral resource rich country, mining has long been a critical part of the Australia's GDP, as much as 11 percent in 2020.<sup>23</sup> Australia also competes with Canada on a roughly equal basis for mining finance, with Australia edging-out Canada with a slightly greater share of global mining exploration expenditures (\$1.5 billion versus \$1.3 billion) in 2019.<sup>24</sup> Australia also holds vast deposits for a variety of mineral-based strategic and critical materials, citing twenty-one of the thirty-five minerals on the "critical minerals" list under E.O. 13817.

The Australian Government has created a Critical Minerals Facilitation Office and expanded the eligibility of Export Finance Australia to support the development of critical minerals projects. Key objectives of this office are enabling and attracting investment, international engagement, project finance, overseeing minerals research, and developing Australia's national strategy for critical minerals. In its recently published Australian Critical Minerals Prospectus 2020, Australia identified dozens of potential projects, ranging from early exploration to "shovel-ready" projects.<sup>25</sup>

<sup>22</sup> U.S. Geological Survey, *International Geoscience Collaboration to Support Critical Mineral Discovery*, Fact Sheet 2020-3025 (July 2020), <https://pubs.er.usgs.gov/publication/fs20203035>

<sup>23</sup> Australian Government, *Why Australia: Benchmark Report* (2021), <https://austrade.gov.au/benchmark-report/resilient-economy>.

<sup>24</sup> Prospectors & Developers Association of Canada (PDAC), *Mineral Finance 2020: Canada Holding Ground* (June 2020), [https://pdac.ca/docs/default-source/priorities/access-to-capital/state-of-mineral-finance-reports/pdac-mineral-finance-2020\\_revised\\_june-18-2020.pdf?sfvrsn=c9ec9b98\\_2](https://pdac.ca/docs/default-source/priorities/access-to-capital/state-of-mineral-finance-reports/pdac-mineral-finance-2020_revised_june-18-2020.pdf?sfvrsn=c9ec9b98_2)

<sup>25</sup> Australian Government, *Australian Critical Minerals Prospectus* (October 2020), <https://austrade.gov.au/international/invest/opportunities/resources-and-energy>

Figure 8: Australian Strategic and Critical Material Deposits<sup>26</sup>

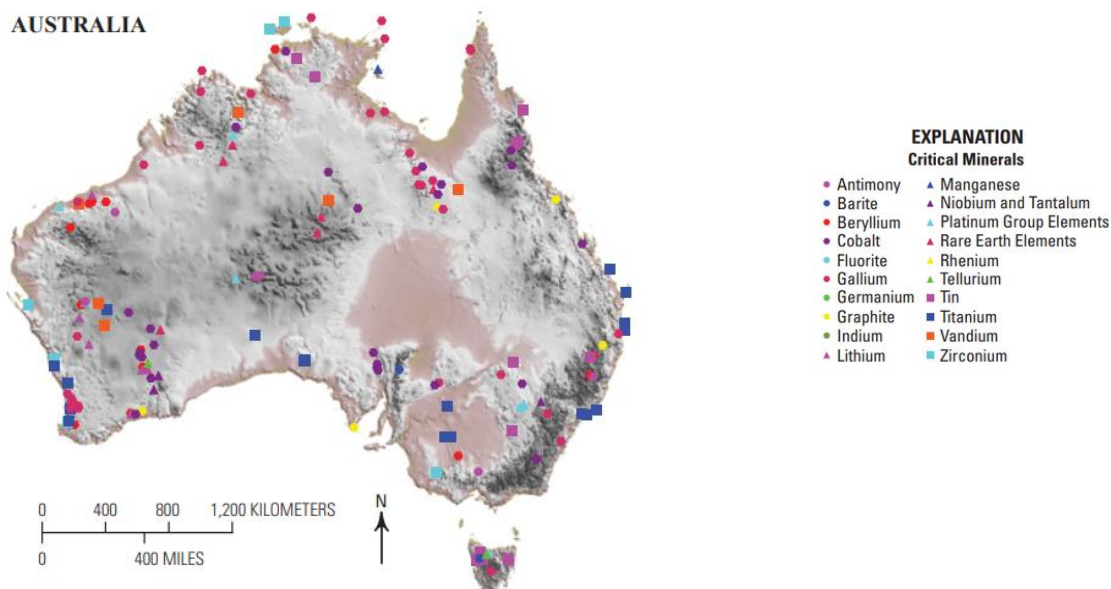

## JAPAN

Japan is another important trading partner and U.S. ally in the Asia-Pacific region. Though not a member of NTIB nor eligible as a domestic source under the DPA, Japan is a “qualifying country” for the purpose of the Defense Federal Acquisition Regulation Supplement (DFARS). Qualifying countries have entered into a reciprocal defense procurement agreement with the United States to remove barriers to the purchase of supplies manufactured in or services provided by the other country.<sup>27</sup> Under particular conditions, a “qualifying country” source is considered equivalent to a domestic source in defense procurement procedures.

Independent of this engagement with DoD, Japan is a founding member of trilateral critical materials cooperation with the United States and the European Union (EU), an effort led by the U.S. Department of Energy. The EU-US-Japan Trilateral on Critical Materials is an important platform for experts from all three parties to exchange technical data and approaches to building secure supply chains for critical materials.

Though not necessarily resource-rich, Japan is a vital player in supply chains for strategic and critical materials—as an import destination, a source of project finance, downstream manufacturing, and a materials R&D hub. After 2010, in response to a territorial dispute with China which led to a *de facto* Chinese embargo on rare earth exports, Japan adopted a coordinated, national policy to diversify its rare earth supply chains, combining R&D related to end-of-life recycling, stockpiling, substituting, and new product development for rare earth elements in over-supply, as well as providing project finance for overseas mining projects.

## EUROPEAN UNION

The principal mechanism through which the United States engages the EU on issues related to strategic and critical materials is through the EU-US-Japan Trilateral, although U.S. industry has also been invited to support EU initiatives to assess their import reliance for “critical raw materials,” a framework similar to

<sup>26</sup> U.S. Geological Survey, *International Geoscience Collaboration to Support Critical Mineral Discovery*, Fact Sheet 2020-3035 (July 2020), <https://pubs.er.usgs.gov/publication/fs20203035>

<sup>27</sup> See DFARS 252.225-7001, Buy American and Balance of Payments Program and directly related clauses under DFARS 252.225.

"critical minerals."<sup>28</sup> The European Commission also released an *Action Plan on Critical Raw Materials* in September 2020, which calls for the EU to reduce its dependence on foreign sources throughout the critical materials value chain.<sup>29</sup>

The United States maintains strong, informal communication with the EU via diplomatic channels to ensure a consistent exchange of ideas, as well as extensive communication related to prospective legislation under the European Green Deal framework and new EU regulation on "conflict minerals," a subset of critical minerals on which the United States also has due diligence requirements under the *Dodd-Frank Wall Street Reform and Consumer Protection Act*.

A particularly instructive work for U.S. policy related to strategic and critical materials is the analysis completed by multiple stakeholders across academia, industry, European and non-European governments, and non-governmental organizations through the European Rare Earth Competency Network (ERECON), with some of this work now taken-up by the emerging European Raw Materials Alliance.<sup>30</sup> Noteworthy recommendations from ERECON included:

- Support promising technologies by funding industry-led pilot plants for innovative heavy rare earth element processing;
- Leveling the playing field for European heavy rare earth exploration through co-funding for pre-feasibility and bankable feasibility studies; and
- Making waste management rare earth-friendly through eco-design, incentive schemes for collecting priority waste products, and streamlining policy and waste regulations.<sup>31</sup>

## Drivers of Market Demand for Strategic and Critical Materials

### *Overview – Growth in the Chinese Market*

As the world's largest national economies, the United States and China are the world's largest direct and indirect consumers of strategic and critical materials.<sup>32,33</sup> The unprecedented growth of the Chinese economy has fueled global growth in strategic and critical material markets, posing a strong incentive to reorient supply chains. Since the end of the Cold War, China's strategic and critical materials industry has expanded many times over (see Figure 9) to meet some of China's domestic demand. Even in cases where other countries conduct the initial beneficiation of a strategic and critical material, China dominates the processing of strategic and critical materials, giving it de facto control over the flow of material through the supply chain.

---

<sup>28</sup> European Commission, *Study on the EU's list of Critical Raw Materials* (September 2020), <https://ec.europa.eu/docsroom/documents/42883/attachments/1/translations/en/renditions/native>

<sup>29</sup> European Commission, *Critical Raw Materials Resilience: Charting a Path towards Greater Security and Sustainability* (September 2020), <https://eur-lex.europa.eu/legal-content/EN/TXT/PDF/?uri=CELEX:52020DC0474&from=EN>

<sup>30</sup> European Commission, *European Rare Earth Competency Network (ERECON)*, [https://ec.europa.eu/growth/sectors/raw-materials/specific-interest/erecon\\_en](https://ec.europa.eu/growth/sectors/raw-materials/specific-interest/erecon_en); European Commission, *European Raw Materials Alliance*, <https://erma.eu/>

<sup>31</sup> European Rare Earths Competency Network, *Strengthening the European Rare Earths Supply-Chain, Challenges and policy options* (October 2014), [https://reinhardbuetikofer.eu/wp-content/uploads/2015/03/ERECON\\_Report\\_v05.pdf](https://reinhardbuetikofer.eu/wp-content/uploads/2015/03/ERECON_Report_v05.pdf)

<sup>32</sup> The World Bank, "GDP (current US\$)", [worldbank.org, https://data.worldbank.org/indicator/NY.GDP.MKTP.CD?most\\_recent\\_value\\_desc=true](https://data.worldbank.org/indicator/NY.GDP.MKTP.CD?most_recent_value_desc=true)

<sup>33</sup> Jeff Desjardins, "China's Staggering Demand for Commodities," [visualcapitalist.com](https://visualcapitalist.com/chinas-staggering-demand-commodities/), March 2, 2018, <https://visualcapitalist.com/chinas-staggering-demand-commodities/>

Figure 9. China's Share of Global Primary Production (1990-2018)<sup>34</sup>

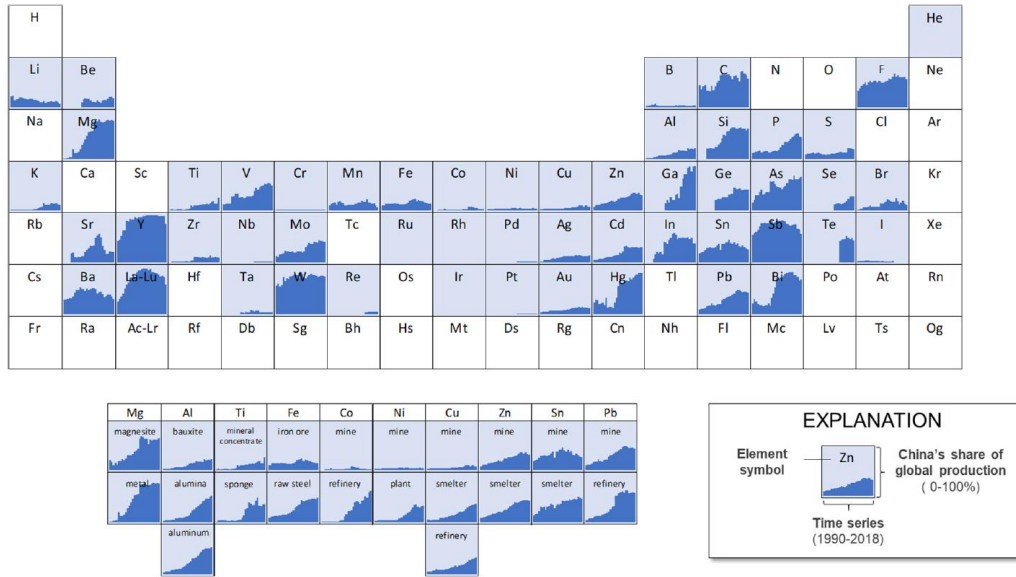

Notwithstanding China's surging domestic production, that production has not kept pace with the rapid expansion of China's economy, from a nominal GDP of \$426 billion in 1992 to \$14.2 trillion in 2019. This substantial growth has led to an equally substantial increase in China's net import reliance for strategic and critical materials (see Figure 10).<sup>35</sup> As China's demand for cobalt, copper, lithium, platinum group metals, and other specialized materials increased, China stepped up its efforts to capture the entire value chain in a variety of modern technologies such as permanent magnets, batteries, and semiconductors.

Figure 10: China and United States Net Import Reliance (Compared)<sup>36</sup>

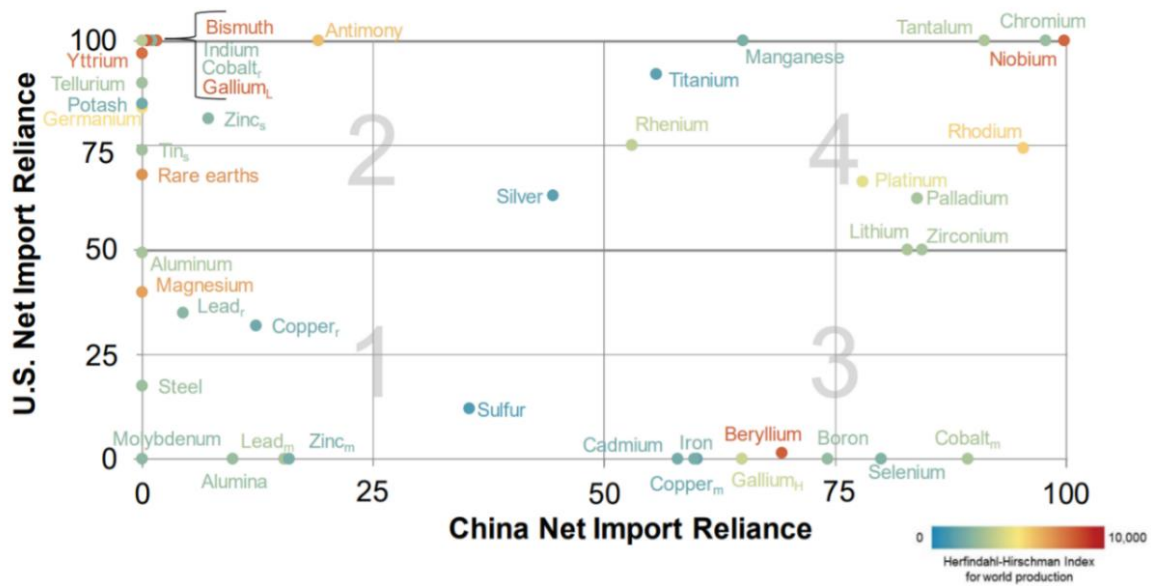

<sup>34</sup> U.S. Department of the Interior, *Investigation and Recommendations on our Nation's Reliance on Foreign Sources of Critical Minerals* (September 30, 2020), see Appendix G

<sup>35</sup> The World Bank, "China," [worldbank.org, https://data.worldbank.org/country/CN](https://data.worldbank.org/country/CN)

<sup>36</sup> Gulley, A.L., Nassar, N.T., and Xun, S., "China, the United States, and competition for resources that enable emerging technologies," *Proceedings of the National Academy of Sciences* (April 2, 2018), <https://pnas.org/content/pnas/115/16/4111.full.pdf>

Meanwhile, China has implemented several policies, such as the Go Out Policy,<sup>37</sup> to accelerate its movement into value-added manufacturing sectors. Strategic and critical materials associated with the lithium-ion battery material supply chain have seen significant Chinese Foreign Direct Investment (FDI) flows, typically accompanied by off-take rights.

For example, China's nominal net import reliance for cobalt ores and concentrates is approximately 97 percent (see "Sector 3" of Figure 10). That result obscures the fact that Chinese companies have actively pursued equity positions or outright ownership in cobalt assets in the Democratic Republic of the Congo, Papua New Guinea, and Zambia. Making the conservative assumption that a Chinese company's equity position in a particular asset is the minimum level of off-take it will purchase, then China's Go Out Policy activities in cobalt have decreased China's net import reliance from 97 percent to 68 percent.<sup>38</sup> In addition, China dominates downstream processing of cobalt (scoring in "Sector 2" of Figure 10), effectively controlling global material flows for processed cobalt.

Of note, the United States' net import reliance for cobalt ores and concentrates is zero. As indicated elsewhere in this report, the absence of net import reliance does not necessarily indicate the absence of risk. In this case, the United States does not import cobalt ores and concentrates because it has no downstream processing capability; consequently, the U.S. has high net import reliance in high value-added forms of cobalt (i.e., "Sector 2") and cobalt embedded in finished goods (e.g., batteries).

#### *Overview – U.S. Demand*

Given their far upstream position relative to the goods and services typically purchased by U.S. consumers, strategic and critical materials impact hundreds of sectors of the U.S. economy, as categorized by the North American Industry Classification System (NAICS).

To capture the relationship between strategic and critical materials to specific industry sectors as well as the inter-dependencies amongst these sectors, DoD uses a combination of input-output and agent-based economic modeling approaches. Due to a combination of statutory requirements (ref: 50 U.S.C. 98h-5) and the intense data requirements to run these models, DoD exercises these models every two years and relies heavily on support from across the Federal Government, including the Departments of Commerce and the Interior, federally-funded research and development centers, U.S. national laboratories, and other Government agencies. DoD also actively engages key domestic and foreign market participants to integrate business proprietary information into these models, to more precisely characterize potential shortfalls to defense or essential civilian requirements during postulated national emergency or peacetime disruption scenarios. The results of this modeling exercise are in Appendix A.

By way of example, the interagency has collected direct demand import statistics for rare earth elements from the Department of Commerce and used agent-based modeling in partnership with a national laboratory to develop estimates of embedded demand in downstream sectors of the U.S. economy. To characterize the economic impact of these materials on the broader U.S. economy, these direct and embedded demand quantities, multiplied by market prices, may be compared against manufacturer survey data, also collected by the Department of Commerce.

In the case of rare earth elements (see Figure 11), approximately \$613 million in U.S. consumption of rare earth elements unlocks approximately \$496 billion in economic activity in essential civilian sectors including

---

<sup>37</sup> U.S.-China Economic and Security Review Commission, *Going Out: An Overview of China's Outward Foreign Direct Investment* (March 2011), <https://uscc.gov/sites/default/files/Research/GoingOut.pdf>

<sup>38</sup> U.S. Department of the Interior, *Investigation and Recommendations on our Nation's Reliance on Foreign Sources of Critical Minerals* (September 30, 2020), see Appendix G

petroleum refining, electromedical device manufacturing, automotive manufacturing, and search, detection, and aeronautical instrument manufacturing.







## *Green Energy Demand*

To avoid the worst impacts of the climate crisis, the Biden-Harris Administration has committed to 50 percent or more reduction of carbon dioxide (CO<sub>2</sub>) and non-CO<sub>2</sub> greenhouse gas pollution by 2030,<sup>1</sup> with a long-term goal to reach net-zero emissions 2050. Though Federal action is important, consumer and investor demands, combined with private-sector investment, increasingly are aligned around this level of ambition.

The supply chain impact of deploying clean technologies at scale are significant and will require secure, reliable access to strategic and critical materials. Examples of mineral-based clean technologies include rare earth elements for permanent magnets in electric vehicles and wind turbines; battery grade cobalt, lithium, manganese, nickel, and graphite for vehicle batteries and grid storage; gallium and many other materials for semiconductors used in LEDs and power electronics used in wind and solar systems; and magnesium and aluminum for vehicle lightweighting.

The Department of Energy leads the U.S. Government's evaluation of strategic and critical material demand modeling for green energy and energy conservation technologies through its Critical Materials Strategy.<sup>2</sup> Independent of this assessment withheld as Controlled Unclassified Information by the Department of Energy, industry assessments indicate that forthcoming demand for battery-grade nickel, cobalt, and lithium is expected to expand dramatically with global uptake in electric vehicles and stationary storage batteries (see Figure 12). The projected demand for electric vehicles also is expected to drive demand for the rare earth elements used in the magnets, even more so than is the case today.

The United States can develop secure and resilient supply chains for clean technologies with a broad value-based policy approach, including continuous research, primary production, downstream manufacturing, and recycling. Given the environmental and labor legacy of mining, increased mineral production and reclamation activities must be held to modern environmental standards, require best-practice labor conditions, and consultation with affected communities, including Tribal Nations in government-to-government consultation. In doing so, the United States will make crucial progress towards meeting U.S. economic and climate objectives.

---

<sup>1</sup> The White House, *Fact Sheet: President Biden Sets 2030 Greenhouse Gas Pollution Reduction Target Aimed at Creating Good-Paying Union Jobs and Securing U.S. Leadership on Clean Energy Technologies* (April 22, 2021), <https://www.whitehouse.gov/briefing-room/statements-releases/2021/04/22/fact-sheet-president-biden-sets-2030-greenhouse-gas-pollution-reduction-target-aimed-at-creating-good-paying-union-jobs-and-securing-u-s-leadership-on-clean-energy-technologies/>

<sup>2</sup> See Appendix B.

Figure 12: Expanding Global Lithium-Ion Battery “Megafactories”<sup>3</sup>

## Megafactory capacity forecast by tier ranking

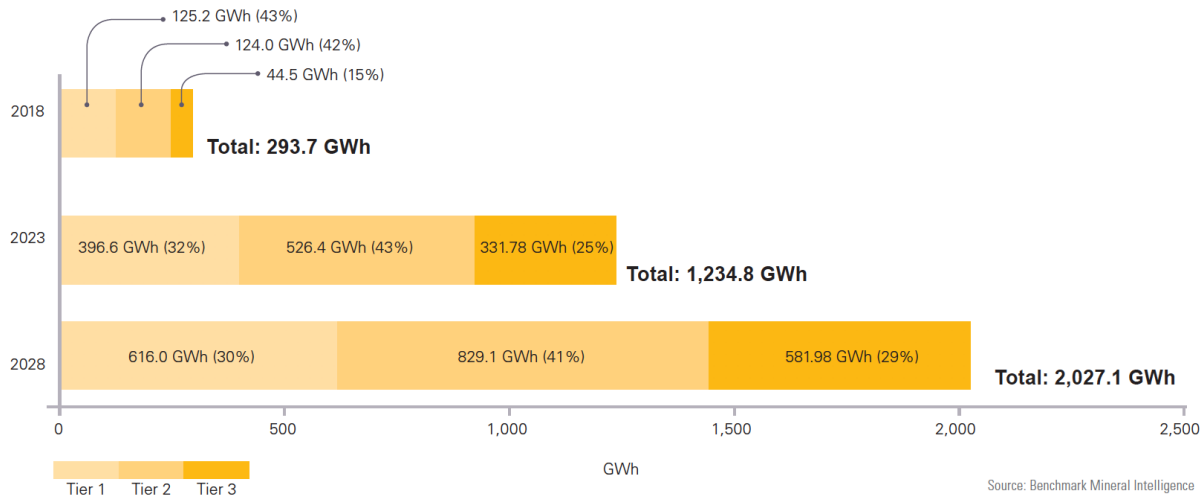

## Decline in U.S. Production and Processing Operations

### Focus on Low-Cost Production

Private sector participants are experts at *seeking global low-cost producers* for strategic and critical materials. A significant driver of this low-cost profile is natural, comparative advantage from unique geologic occurrences or an abundance of related consumables and utilities (e.g., water and power). On the other hand, comparative advantage also may result from negative market interventions, such as a general disregard for worker health and safety, waste-water or hazardous emissions, and forced labor.

For instance, the chemical materials used to manufacture energetic compounds frequently use extraction or synthesis routes that have environmentally harmful waste streams. These waste streams can be controlled only with costly mitigation equipment. Countries whose environmental regulations are relatively lax (or even non-existent) can produce critical materials at a lower price, weakening suppliers where the regulations are more stringent. In addition, government intervention may create a comparative advantage by providing tax incentives and credits, subsidies, and other non-cash benefits. This latter type of economic tradeecraft is difficult to challenge, outside of lengthy and sometimes costly enforcement actions using domestic and international trade dispute settlement fora.

### Product Differentiation

Strategic and critical materials also operate at two very different product extremes. On the one hand, the primary extraction of many strategic and critical materials occurs as a byproduct or co-product of much larger industrial markets—such as the recovery of rare earth elements from iron ore processing, or germanium from zinc refining. Consequently, producers and consumers generally treat many strategic and critical materials like commodity products, with very little product differentiation among producers.

Counterintuitively, for the exact same strategic and critical materials, their downstream, value-added forms may be so differentiated that the materials are unique and proprietary to a single company. Though thrifting may be possible at upstream supply chain tiers, downstream material forms are not readily substitutable in their end-use application, and market demand is tightly concentrated in only a handful of applications. High performance carbon fibers are an example of this trend. Though many different carbon fibers are available

<sup>3</sup> Benchmark Mineral Intelligence, “The Three Tiers of Battery Megafactories,” [benchmarkminerals.com](https://benchmarkminerals.com/the-three-tiers-of-battery-megafactories/) (September 13, 2019), <https://benchmarkminerals.com/the-three-tiers-of-battery-megafactories/>; “Tiers” of production refer to (1) qualification for multinational electric vehicle producers outside of China, (2) qualification to supply Chinese electric vehicle producers or other applications, and (3) no prior history of qualified production.

on the market, the specific carbon fibers suitable for the aerospace sector are limited to a mere handful of sources in the world. For select high temperature, high modulus and high strength applications, only one (non-U.S.) factory in the world is qualified to produce this material.

### *Permitting of Domestic Strategic and Critical Materials Production*

Mining operations— particularly when conducted outside of established governance— can have a significant impact on the environment, including habitat destruction, air and water pollution, hazardous waste generation, and other issues. As such, U.S. mining projects must comply with state and Federal laws, and overseas mining projects must adhere to local laws and global standards designed to mitigate these impacts and protect human health and the environment.

The process of permitting and conducting environmental assessments, environmental impact statements, and related work are a separate time variable, additive to or concurrent with the decade-long development timeline for strategic and critical materials projects. The National Environmental Policy Act (NEPA), the Clean Water Act, and the Clean Air Act are three commonly cited statutes affecting the strategic and critical materials industry. NEPA also requires Federal agencies to consider the environmental impacts of proposed Federal actions and generally provide opportunities the public for input. The mission of the Clean Water Act is “ to restore and maintain the chemical, physical, and biological integrity of the Nation’s waters.” Various aspects of the industry potentially influence nearby surface water and groundwater sources, including discharges from initial ore extraction and multiple downstream processing operations (e.g., solvent extraction). The Clean Air Act, first adopted in 1955 and modified in 1970, regulates emission limits on 187 dangerous pollutants. Mine plan of operations approvals by Federal land management agencies under Federal mining regulations are required for mining operations on Federally-managed lands. Mining operations also are subject to State permits and approvals.

Industry and related consulting groups have routinely cited the environmental regulatory process as an impediment to strategic and critical materials production. Behre Dolbear, an industry advisory firm, regularly evaluates the global mining sector using seven criteria relevant to a nation’s business climate.<sup>4</sup> The United States consistently scores high marks for the stability of its economic and political system, as well as currency stability and active policing of corruption in the sector. But Behre Dolbear reporting also consistently gives the U.S. very low marks related to permitting risk, citing approximately seven to ten years to obtain the relevant permits for full-scale operations.

On the other hand, more recent analysis by the Fraser Institute related to the investment climate for mining exploration indicates that the U.S., on the whole, several U.S. States<sup>5</sup>, in particular, are among the best jurisdictions in the world.<sup>6</sup> Similarly, a Government Accountability Office evaluation of U.S. Government mine plan reviews found that approval processes, including NEPA, took from 1 month to 11 years, with an average time of 2 years.<sup>7</sup> This evaluation further identified several key challenges to timely review and approval of mine plans, such as incomplete or vague mine plans, insufficient Federal Government staff to conduct reviews, changes in mine plans after submission, or complex or unusually high potential environmental impacts.

---

<sup>4</sup> Behre Dolbear, *2014 Ranking of Countries for Mining Investment* (2014), <https://dolbear.com/wp-content/uploads/2016/04/2014-Where-to-Invest.pdf>

<sup>5</sup> Such as Idaho, Wyoming, Nevada, Utah, Alaska, and Arizona.

<sup>6</sup> Jairo Yunis and Elmira Aliakbari, *Fraser Institute Survey of Mining Companies 2020* (February 23, 2021), <https://www.fraserinstitute.org/studies/annual-survey-of-mining-companies-2020>

<sup>7</sup> U.S. Government Accountability Office, *Hardrock Mining, BLM and Forest Service Have Taken Some Actions to Expedite the Mine Plan Review Process by Could Do More* (January 2016), <https://www.gao.gov/assets/gao-16-165.pdf>

### *China's Non-Market Activities*

Whereas the United States is a market economy, the U.S. Department of Commerce classifies China as a non-market economy, meaning China does not “operate on market principles of cost or pricing structures, so that sales of merchandise in such country do not reflect the fair value of the merchandise.”<sup>8</sup>

This characterization reflects markedly different policy preferences in commercial markets, made particularly stark for strategic and critical materials. The dwindling U.S. production base for rare earth elements and rare earth-derived products illustrates these differences in policy choices and outcomes.

In the 1990s, the United States largely allowed its domestic rare earth market to operate under market principles, with small carve-outs for defense-specific requirements. Meanwhile, according to the U.S. International Trade Commission, Chinese companies were circumventing various intellectual property rights in their exports of low-cost NdFeB magnets to the U.S. market.<sup>9</sup> In 2003, following acquisition by a conglomerate including a Chinese entity, the United States’ leading NdFeB magnet producer ceased operations and relocated its operations to China in 2003.<sup>10</sup> Similarly, in 2015, the United States, Japan, and the E U successfully challenged China’s rare earth export quota administration system through the World Trade Organization (WTO) dispute settlement mechanism, which agreed that those export restraints violated WTO rules.<sup>11</sup> Yet, over the course of this period, from 1992 to 2020, the United States lost at least four NdFeB production facilities,<sup>12</sup> and the United States also lost at least three rare earth separation facilities.<sup>13</sup>

By contrast, the Chinese Government has focused on capturing discrete strategic and critical material markets as a matter of state policy. For example, China implemented a value-added tax (VAT) rebate for rare earth exports in 1985, which contributed to the erosion and then elimination of U.S. production in the global market. Figure 13 depicts the growth of China’s rare earth exports from the 1960s to the present. In 2002, China’s National Development Planning Commission issued the *Interim Regulations on the Management of Foreign Investment in the Rare Earth Industry*, which prohibited foreign investors from establishing rare earth mining enterprises in China and exclusively owning and controlling rare earth smelting and separation projects. In January 2014, China’s Ministry of Industry and Information Technology took the lead in forcing the vertical and horizontal integration of Chinese rare earth companies — pushing privately-held rare earth miners out of the market in favor of a handful of national champions. This central planning and active management of the rare earth industrial base continues, with new draft management regulations under review and even more expansion projects underway.

---

<sup>8</sup> See 19 U.S.C. 1677(18)(A)

<sup>9</sup> U.S. International Trade Commission, *In the Matter of Certain Neodymium-Iron-Boron Magnets, Magnet Alloys, and Articles Containing Same*, Investigation No. 337-TA-372, Publication 2964 (May 1996), <https://usitc.gov/publications/337/pub2964.pdf>

<sup>10</sup> David Moberg, “Magnet Consolidation Threatens both U.S. Jobs and Security,” *In These Times* (January 23, 2004), <https://inthesetimes.com/article/magnet-consolidation-threatens-both-us-jobs-and-security>

<sup>11</sup> World Trade Organization, Dispute Settlement (Summary), DS431, “China – Measures Related to the Exportation of Rare Earths, Tungsten, and Molybdenum” (May 2015), [https://wto.org/english/tratop\\_e/dispu\\_e/cases\\_e/ds431\\_e.htm](https://wto.org/english/tratop_e/dispu_e/cases_e/ds431_e.htm)

<sup>12</sup> Walter T. Benecki, “Magnetics Industry Overview: 2005 – Another Year of Significant Change in the Magnetics Industry,” [waltbenecki.com](http://waltbenecki.com) (November 2005), [https://waltbenecki.com/uploads/Another\\_Year\\_of\\_Significant\\_Change\\_in\\_the\\_Magnetics\\_Industry](https://waltbenecki.com/uploads/Another_Year_of_Significant_Change_in_the_Magnetics_Industry).

<sup>13</sup> Joseph Gambogi, “Rare Earth Data Sheet,” in U.S. Geological Survey, *Mineral Commodity Summaries 2020* (January 2020), <https://pubs.usgs.gov/periodicals/mcs2020/mcs2020-rare-earths.pdf>

Figure 13: Global Rare Earth Production (1960-2020)<sup>14</sup>

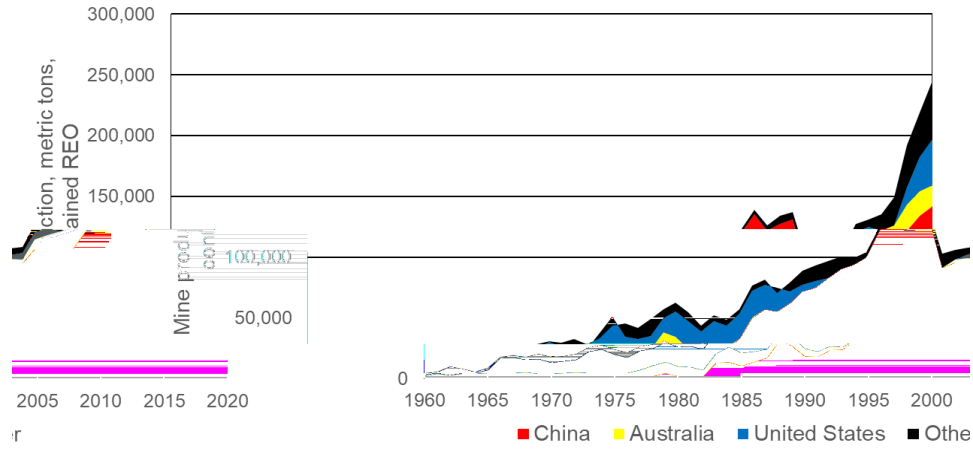

## RISK ASSESSMENT

### Overview

As noted in its reports on the health of the defense industrial base,<sup>15</sup> DoD assesses risk in the strategic and critical materials sector in two tiers, at and below the level of armed conflict. DoD models the former set of risk factors on a biennial basis, in accordance with its duties as the National Defense Stockpile Manager under the Strategic and Critical Materials Stockpiling Act of 1979 (50 U.S.C. 98 et seq.).

Though the magnitude of harm from market disruptions during armed conflict is high, the underlying causes of these market disruptions are not new. Instead, the scenario levies a uniquely intense set of requirements upon an already fragile market. This fragility exists today—under conditions well below the threshold of Armed Conflict—and generally results from market forces pushing firms to pursue the most economically efficient or lowest-cost pathway to satisfy demand.

Over the past decade, peacetime supply chain disruptions have increased in frequency and intensity. The COVID-19 pandemic is only the most recent, albeit severe, shock to global supply chains, but private sector companies must also contend with risks ranging from climate-induced power outages to cyber-attacks and disruption of shipping lanes. Core drivers of this absence of resilience in the strategic and critical materials sector include the following risk factors:

- Concentration of Supply
- Single-Source Suppliers
- Price Shocks
- Human Capital Gaps
- Conflict Minerals and Organized Crime
- Forced Labor

### Risk Factors below the Level of Armed Conflict

#### *Concentration of Supply*

Independent of direct U.S. imports, a significant portion of global production for strategic and critical materials is concentrated in only one or a few countries. This lack of supplier diversity creates not only market challenges for nascent producers, it also means a large portion of global supply is subject to single

<sup>14</sup> Derived from U.S. Geological Survey data.

<sup>15</sup> Department of Defense, *Fiscal Year 2019 Industrial Capabilities Report to Congress* (June 2020), <https://www.businessdefense.gov/Portals/51/Documents/Resources/USA000954-20%20RPT%20Subj%20FY19%20ICR%2007092020.pdf?ver=2020-07-10-124452-180>

point disruption risk (e.g., natural disasters, shifting industrial or trade policies). Figure 14 shows that, on average, across select strategic and critical materials, supplier diversity decreased from 2000 to 2014.

Figure 14: Market-Share of Largest Global Producers for Select Materials<sup>16</sup>

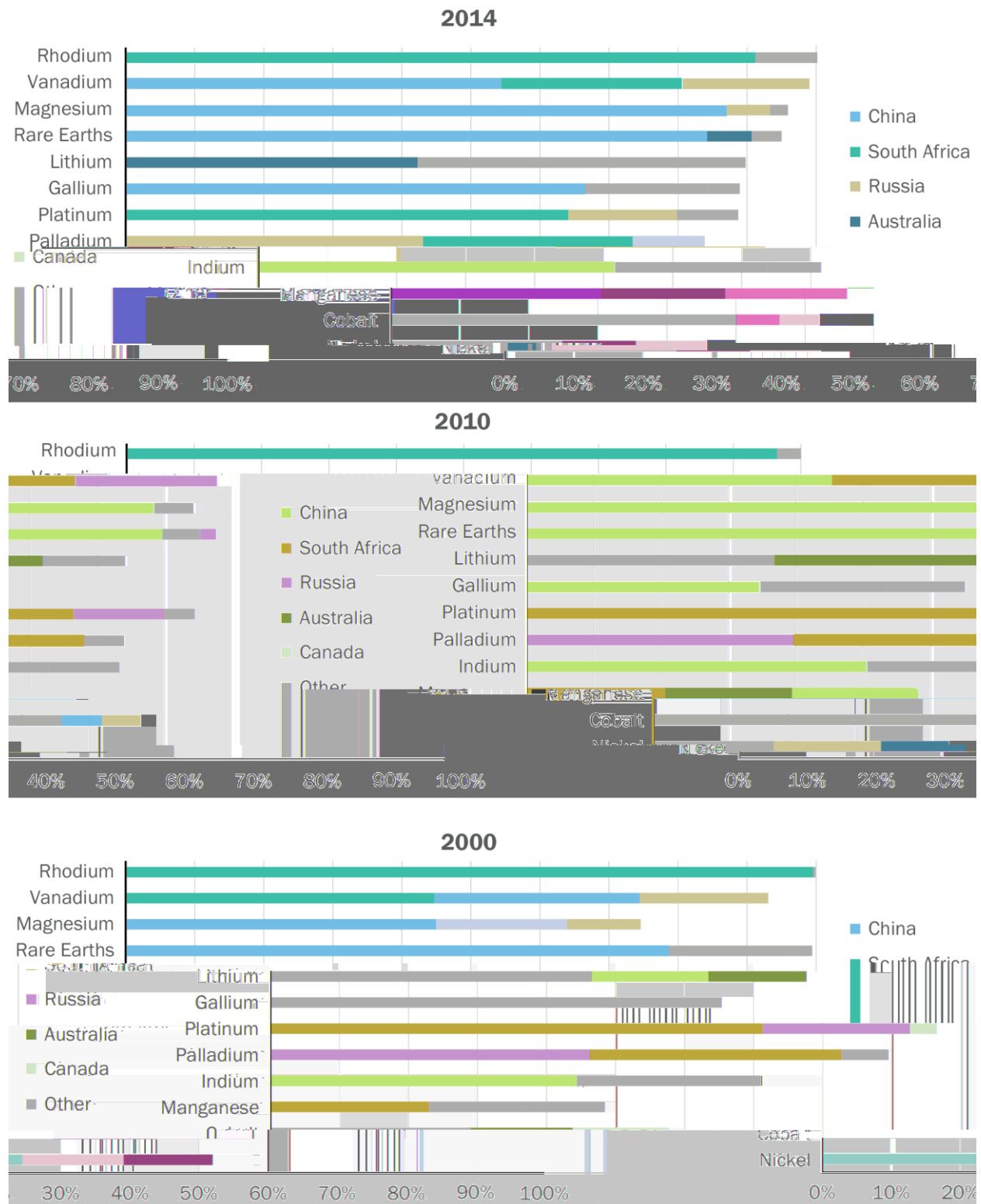

<sup>16</sup> Department of Energy, “Figure 2-3. Comparison of share of the three largest global producers of select materials (2000, 2010, and 2014),” *Critical Materials Strategy* (February 2019), p 16.



When a particular country's share of global production exceeds half of global production for a particular strategic and critical material, that country is considered a "foreign market dominator" for the purposes of DoD's input-output or agent-based economic modeling.<sup>17</sup> Figure 15 displays a list of 37 shortfall strategic and critical materials (see the section, *Risk Factors at the Level of Armed Conflict*) that exhibit this foreign market dominator criterion.

Figure 15: Strategic & Critical Materials Subject to a Foreign Market Dominator

Aluminum, high purity	Manganese metal, electrolytic
Arsenic, molecular beam grade	Neodymium
Barium	Niobium
Beryllium metal	Praseodymium
Beryllium ore, beryl ore	Rare earth permanent magnets, NdFeB types
Bismuth	Rare earth permanent magnets, Samarium Cobalt types
Carbon-Carbon (multiple)	Samarium
Cerium	Scandium
Erbium	Steel, 1080 grade ultra-high strength cable tire cord
Energetic Materials <sup>18</sup>	Steel, grain oriented electrical steel silicon-based
Europium	Strontium
Fluorspar, acid grade	Tin, low alpha
Graphite, iso-molded civilian grade	Tungsten, ammonium paratungstate
Graphite, iso-molded defense grade	Tungsten, ores and concentrates
Lanthanum	Yttrium oxide
Lithium metal	Zirconium
Magnesium metal	

#### *Byproduct and Coproduction Dependency*

Byproduct production of strategic and critical materials can add significant value to an existing production operation and improve the business case for a nascent producer. However, some strategic and critical materials are derived exclusively from byproduct production, which means a fairly small market depends on the prevailing dynamics of a separate but much larger commodity market. A mapping of this dependence is shown in Figure 16.

<sup>17</sup> The computation of the fraction of world supply that a specific country provides is made before any of the conflict-related decrements are applied to its supply level.

<sup>18</sup> Multiple types, see Appendix H.

Figure 16: Co-Production Dependency<sup>19</sup>

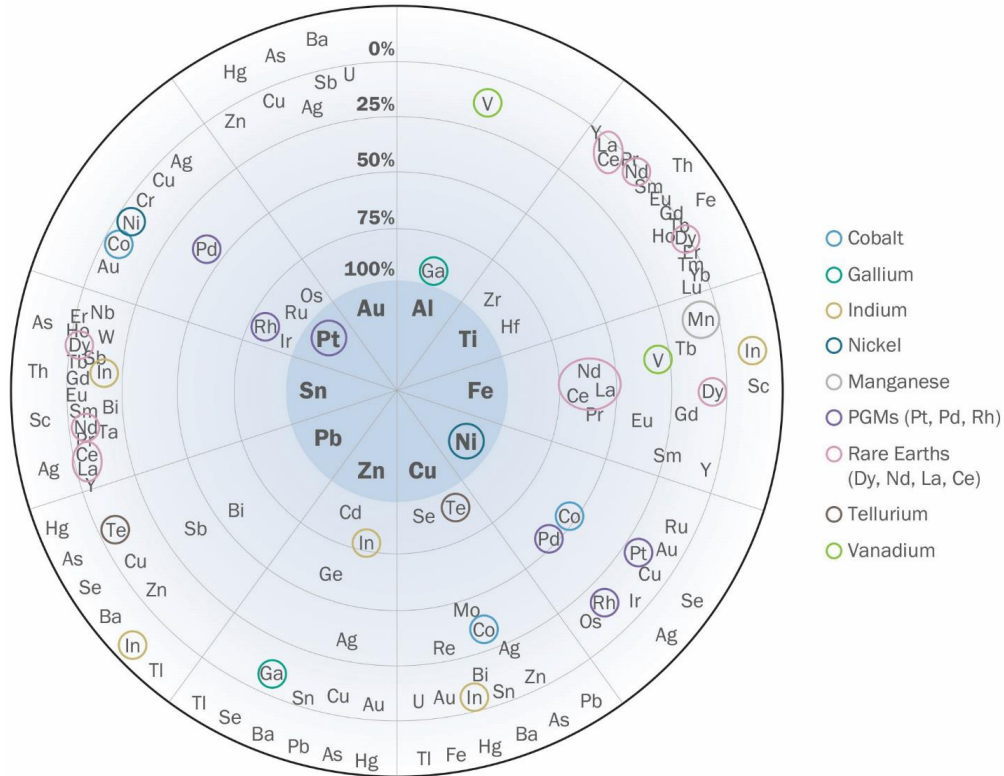

*Single Source Production*

In some cases the concentration of supply can be so extreme that U.S. or global production is concentrated in a single source. Current domestic sole-source, or single points of failure, in shortfall strategic and critical material supply chains (see *Risk Factors at the Level of Armed Conflict*) are shown in Figure 17.

Figure 17: Select Domestic Sole-Source Strategic and Critical Materials

Aluminum, high purity	Magnesium metal
Aluminum-lithium alloys	Manganese, ferromanganese
Barium	Rare earth permanent magnets, SmCo types
Beryllium metal	Steel, grain oriented electrical steel silicon-based
Beryllium ore, beryl ore	Strontium
Boron powder	Tantalum
Boron-10 Isotope <sup>20</sup>	Tin, low alpha
Energetic Materials <sup>21</sup>	

<sup>19</sup> N. T. Nassar, T. E. Graedel and E. M. Harper, “By-product metals are technologically essential but have problematic supply,” *Science Advances* (2015), <https://advances.sciencemag.org/content/1/3/e1400180>. This figure demonstrates the relationship between critical materials that are produced as by-products of primary products. This figure does not provide a complete picture of all minerals on the Federal List of Critical Minerals, 2018, <https://federalregister.gov/documents/2018/05/18/2018-10667/final-list-of-critical-minerals-2018>.

<sup>20</sup> **Note:** the Department of Defense has run only a limited number of isotope supply chains through its modeling process for the National Defense Stockpile program. The Department of Energy maintains robust monitoring of and participation in the isotope market, and at-risk materials are covered in Appendix D and Appendix E

<sup>21</sup> See Appendix A and Appendix H

More generally, in DoD modeling of strategic and critical materials under national emergency conditions, a domestic sole-source provider exists for 29 of the 53 unclassified shortfall materials, and 18 materials have no domestic production at all. Figure 19 illustrates U.S. reliance on single domestic producers for 83 percent of shortfall materials for which domestic production exists. Outside of this assessment of strategic and critical material supply chains, other DoD surveys have found that approximately 75 percent of energetic materials used in defense supply chains are sole-source products (see Appendix H).

Figure 19: Domestic Producers for Unclassified Shortfall Materials

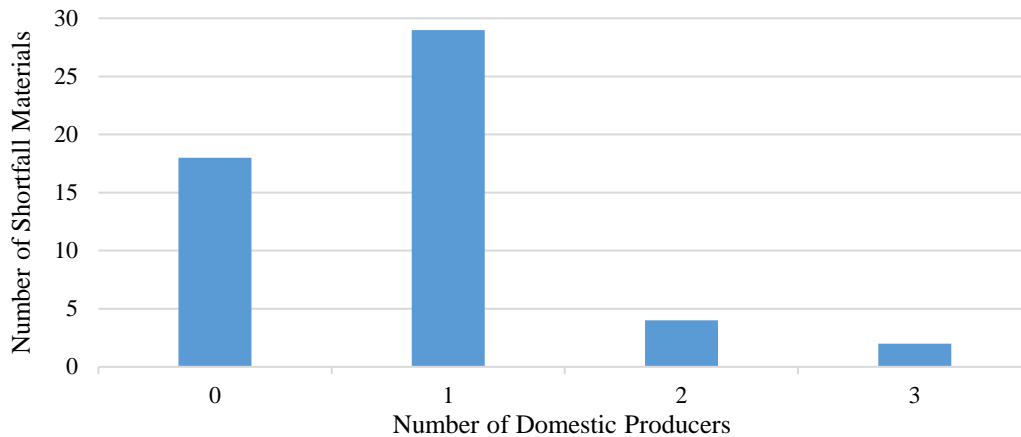

### *Skills and Human Capital Development Gaps*

DoD's *Fiscal Year 2020 Industrial Capabilities Report to Congress* highlighted the vulnerability of a "shrinking workforce" in advanced manufacturing. There is a mismatch between the skill needs of advanced manufacturers *vis-à-vis* the training programs available. Programmatic responses to education and training needs still focus on four-year STEM-based<sup>22</sup> programs rather than on digital industrial skills on the factory floor. The Department of Commerce has summarized the real, yet seldom recognized, challenge to U.S. economic competitiveness from labor shortfalls in the strategic and critical materials sectors as follows:

The entire U.S. critical minerals supply chain faces workforce challenges, including aging and retiring personnel and faculty; public perceptions about the nature of mining and mineral processing; and foreign competition for U.S. talent. Unless these challenges are addressed, there may not be enough qualified U.S. workers to meet domestic production needs across the entire critical minerals supply chain.<sup>23</sup>

For more than 35 years, the number of colleges and universities with mining and extractive metallurgy production programs has steadily decreased. A number of major colleges and universities have eliminated their mining departments altogether. Others have reduced their emphasis in mining and minerals engineering.<sup>24</sup> Former colleges of mining engineering have downsized to the point where they now exist as smaller departments under a university's college of engineering. A principal reason for this decline in education and knowledge is the reduced U.S. demand for mining engineers and technicians.

<sup>22</sup> STEM stands for Science, Technology, Engineering, and Mathematics.

<sup>23</sup> U.S. Department of Commerce, *A Federal Strategy to Ensure Secure and Reliable Supplies of Critical Minerals* (June 4, 2019), [https://commerce.gov/sites/default/files/2020-01/Critical\\_Minerals\\_Strategy\\_Final.pdf](https://commerce.gov/sites/default/files/2020-01/Critical_Minerals_Strategy_Final.pdf)

<sup>24</sup> J. Harrison Daniel, "The Circumstances, Events and Politics Leading the Closure of the U.S. Bureau of Mines: Was It the Correct Decision?" *Mining Engineering*, Vol. 62, No. 4 (April 2010): p 20, <https://me.smenet.org/abstract.cfm?preview=1&articleID=436&page=20>

With the elimination of these types of colleges and university departments, ostensibly for lack of funding or demand or both, now only a handful of mining and mineral-related degree-granting university programs are left in the United States. This decline follows the defunding of the Bureau of Mines (USBM) 25 years ago, which issued educational grants and assisted university programs across the country. By way of comparison, China has 39 universities granting mineral processing and metallurgy degrees, thousands of undergraduate and graduate students.

Many other downstream manufacturers continue to struggle to recruit and retain skilled workers, according to a recent survey of small and medium-sized manufacturers (i.e., those with fewer than 500 employees) by the Manufacturing Institute's Center for Manufacturing Research. When asked to identify the skills most difficult to fill, 77 percent identified manufacturing and production skills, followed by maintenance, repair and installation (42 percent), and engineering (39 percent).<sup>25</sup>

Other evidence indicates hiring difficulties are concentrated among roughly one-quarter of U.S. manufacturers, suggesting the skills challenge in U.S. manufacturing is manageable and amenable to targeted policy action.<sup>26</sup> Forging and incentivizing better structured connections between community and technical colleges and manufacturers for well-defined industrial skills pipelines is needed to address shortages of skilled labor in the United States. In one survey, most U.S. manufacturers reported that, though they were aware of a community college in their region, only about half reported that they had conversations with the college regarding skill issues and only about a quarter actually used a community college for hiring new employees or training incumbent workers.<sup>27</sup>

Insufficient domestic workforce capabilities also represents a significant economic loss for the United States. For example, during the last available reporting period, China's rare earth mining industry and smelting industry employed 4,000 and 40,600 people, respectively. These industries also generated \$1.1 billion and \$10.5 billion in revenue over the same period, for a revenue to employment ratio of approximately \$265,000 and \$258,000 per employee.<sup>28</sup> Of note, rare earth mining and smelting operations are concentrated in non-urban provinces in which the average annual mining salary is less than \$9,500 per year.<sup>29</sup>

#### *Conflict Minerals, Forced Labor, Organized Crime, and Related Vulnerabilities*

The production and trade of strategic and critical materials may involve a range of chain-of-custody risks at the mine site and at each subsequent node. Human rights violations, including forced or child labor, profiteering by non-state actors, environmental pollution, the role of organized crime, and corruption are increasingly concerning factors for minerals and materials supply chains. In response, modern consumers, market economies, and even some non-market jurisdictions are increasingly demanding that private sector supply chains conduct extensive due diligence and achieve higher production standards. This dynamic is playing out across many different types of supply chains, from clothing to chocolate, and critical minerals and materials are no exception.

It is important to note that many of these issues are often associated with artisanal and small-scale mining when addressing mining at the source. Those valid issues notwithstanding, large-scale mining also carries many of these same issues and concerns.

---

<sup>25</sup> The Manufacturing Institute, *The Manufacturing Institute—BKD Small and Medium-Sized Manufacturers Survey, February 2021: The 'New Normal' and Post-Pandemic Workforce Challenges* (February 2021), <https://themanufacturinginstitute.org/wp-content/uploads/2021/02/BKD-MI-Survey-Feb2021.pdf>

<sup>26</sup> Andrew Weaver and Paul Osterman, "Skill Demands and Mismatch in U.S. Manufacturing," *Industrial and Labor Relations Review*, Vol. 70, No. 2 (March 2017), <https://journals.sagepub.com/doi/10.1177/0019793916660067>

<sup>27</sup> Paul Osterman and Andrew Weaver, "Community Colleges and Employers: How Can We Understand their Connection?" *Industrial Relations*, Vol. 55, No. 4 (October 2016), pp 523-545, [https://papers.ssrn.com/sol3/papers.cfm?abstract\\_id=2835733](https://papers.ssrn.com/sol3/papers.cfm?abstract_id=2835733)

<sup>28</sup> Data derived from the China Economic Census and National Bureau of Statistics of China for the 2013 reporting period.

<sup>29</sup> Data derived from China's National Bureau of Statistics.

The Department of Labor issues three regular assessments<sup>30</sup> on international child and forced labor that serve as a valuable resource for corporate responsibility and law enforcement to prevent and eliminate labor abuses in global supply chains. Though each has a distinct mandate, collectively they document the current situation for child labor, forced labor, and force child labor around the globe. As of the latest release in September 2020, the List of Goods Produced by Child Labor or Forced Labor includes 32 goods and 13 goods, respectively are produced using child labor or forced labor in the mining and quarrying sector. Strategic and critical materials on this list include cobalt, tin, tantalum, and tungsten.

### *Conflict Minerals*

The United States' effort to break the connection between armed groups and profit from valuable minerals was established through Section 1502 of the Wall Street Reform and Consumer Protection Act of 2010—also known as Dodd-Frank 1502. Dodd-Frank 1502 defines “conflict minerals” cassiterite, columbite-tantalite, wolframite, gold, or their derivatives, which include tin, tantalum, tungsten (3TG)<sup>31</sup> and requires those companies who manufacture products or contract to have products manufactured that contain 3TG that are necessary to the functionality or production of those products to have certain reporting requirements to the Securities and Exchange Commission (SEC). If a company reasonably believes the 3TG they use may have originated in the Democratic Republic of the Congo (DRC) or its adjoining neighbors, the company is expected to file a conflict-minerals report with the SEC describing its supply chain due diligence efforts aimed at the source and chain of custody of those minerals.

Section 1502 also provides the Secretary of State with the authority to designate additional conflict minerals beyond 3TG, based on a determination that such minerals are financing conflict in the DRC or an adjoining country. In addition, as of January 2021, the EU is implementing a similar regulation covering EU importers of these same minerals when importing from an undefined list of conflict-affected and high-risk areas. The United States and the EU actively support and promote private sector application of the Organization for Economic Co-operation and Development (OECD) Supply Chain Due Diligence for minerals as the key tool for companies to understand their supply chains.

Approximately 1,200 companies provide annual conflict minerals reports to the SEC on their efforts to describe the source and chain of custody of conflict minerals in their supply chains. Given active U.S. reporting requirements and the EU's emerging requirements, the consumer electronic, automotive, aerospace, jewelry, and medical industries — which comprise the bulk of industries most reliant on 3TG — have largely adapted to the resulting culture of supply chain due diligence.

### *Forced and Child Labor*

The Trafficking Victims Protection Reauthorization Act of 2005 (Public Law 109-317) the Department of Labor (DoL) to produce a biannual list of goods it has reason to believe are produced by child or forced labor (TVPRA list). The 2020 TVPRA list features 155 goods in 77 countries. The list includes tin ore, tantalum ore (coltan), and tungsten ore (wolframite) mined with forced labor, including forced child labor, from the Democratic Republic of the Congo (DRC); and gold produced with forced labor, including forced child labor, from Burkina Faso and the DRC. E.O. 13126 on the *List of Products Produced by Forced or Indentured Child Labor* is intended to ensure that Federal agencies do not procure goods made by forced or indentured child labor, and Section 307 of the Tariff Act of 1930 (19 U.S.C. §1307) prohibits importing any product that was

---

<sup>30</sup> U.S. Department of Labor, “Findings on the Worst Forms of Child Labor”, <https://www.dol.gov/agencies/ilab/resources/reports/child-labor/findings>; U.S. Department of Labor, “List of Goods Produced by Child Labor or Forced Labor”, <https://www.dol.gov/agencies/ilab/reports/child-labor/list-of-goods>; U.S. Department of Labor, “List of Products Produced by Forced or Indentured Child Labor”, <https://www.dol.gov/agencies/ilab/reports/child-labor/list-of-products>

<sup>31</sup> Separate from the reporting requirement under Dodd-Frank 1502, Congress also has adopted new procurement restrictions on DoD procurement of end items and materials containing tantalum and tungsten metal products, as well as two forms of rare earth permanent magnets. These procurement restrictions are implemented in 10 U.S.C. 2533c.

mined, produced, or manufactured wholly or in part by forced labor, including forced or indentured child labor.

To help mitigate these risks of child labor and forced labor in supply chains, including in the extractive sector, DoL developed *Comply Chain: Business Tools for Labor Compliance in Global Supply Chains*. Comply Chain provides practical, step-by-step guidance on critical elements of social compliance and is designed for companies that do not have a social compliance system in place or those needing to strengthen their existing systems.

### *Transnational Organized Crime (TOC)*

TOC groups, including drug traffickers and insurgent groups, use illegally mined gold and other materials to reap billions in illicit profits. They also use gold trafficking to launder profits from other illicit activities. Though gold is not a strategic and critical material, government policy in this area is highly instructive for strategic and critical materials more generally. The United States does not have criminal laws to investigate commodities that have been illegally mined in other jurisdictions, and so U.S. law enforcement organizations increasingly have relied on Federal money laundering statutes to address this illicit activity.

Working with the Organization of American States, for example, the State Department has established a regional enforcement system to combat illegal mining financial structures. This project builds the capacity of authorities in Brazil, Colombia, Ecuador, Guyana, Peru, and Suriname responsible for combatting illegal gold mining in order to increase investigations and convictions for crimes related to illegal mining and increase the quantity and value of seized and confiscated assets linked to illegal mining criminal networks in all targeted countries.

### *Market/Economic Shocks*

Strategic and critical materials markets are often very small and, because efforts to increase production are complex project finance undertakings, supply is relatively inelastic in the short-run. Recent data collected by the Critical Minerals Subcommittee of the National Science and Technology Council (NSTC), shows aggregate supply for several strategic and critical materials slowly rising over the long-term. Over the same period, however, this NSTC subcommittee found significant short-run price volatility for many of the same strategic and critical materials (see Figure 19 and Figure 20).

Figure 19: Annual Global Production (Select Materials, 2000-2014)<sup>32</sup>

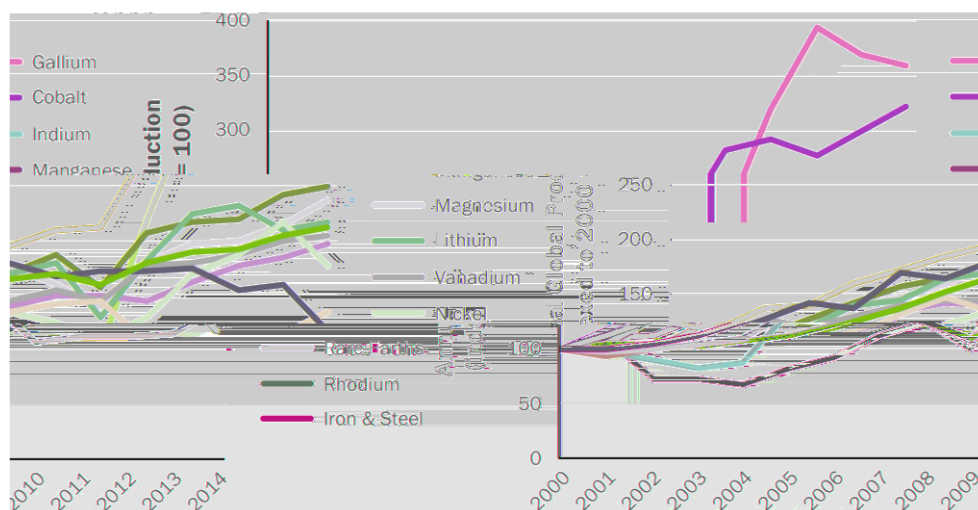

<sup>32</sup> Derived from National Science and Technology Council, *Assessment of Critical Minerals: Updated Application of Screening Methodology* (Washington, DC: NSTC, February 2018), <https://trumpwhitehouse.archives.gov/wp-content/uploads/2018/02/Assessment-of-Critical-Minerals-Update-2018.pdf>

Figure 20: Indexed Annual Price (Select Materials, 2000-2014)<sup>33</sup>

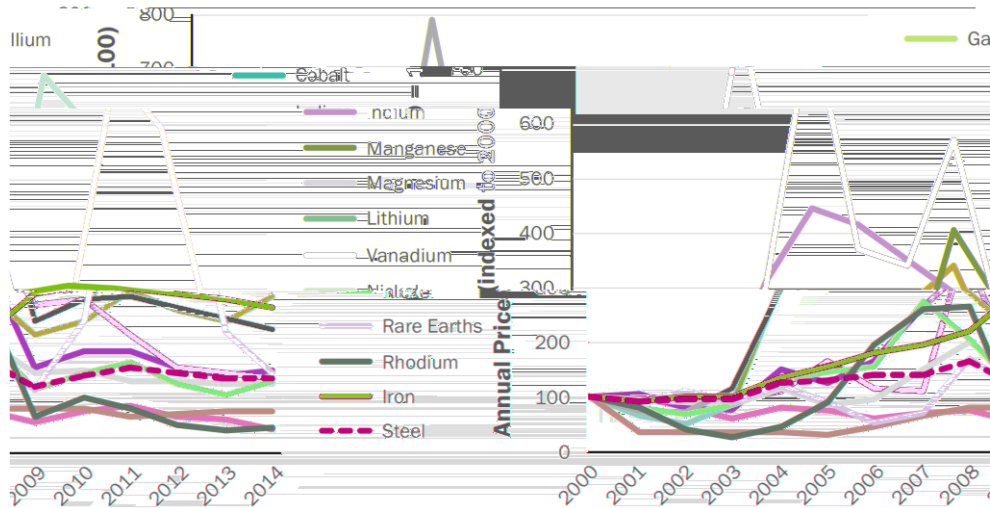

Perhaps the best-known case of significant price volatility in the strategic and critical materials market was the massive shift in prices for rare earth elements over the course of 2010 and 2011 (see Figure 21). In short, the combined effects of changes in the administration of China's rare earth export policies, a territorial dispute between Japan and China in the East China Sea, and capricious enforcement of Chinese customs led to exponential increases in rare earth prices. Anecdotally, price quotes for select rare earth materials were available to U.S. buyers for only a few hours, before the pledged materials (at that price) would be taken by other consumers. The price spike set-off a wave of R&D, substitution, and some supply-side investments, but by the time the rare earth prices returned to "normal" after 2014, the market pressure to diversify supply chains had waned.

Figure 21: Prices for Select Rare Earth Elements, Benchmarked (2002-2019)

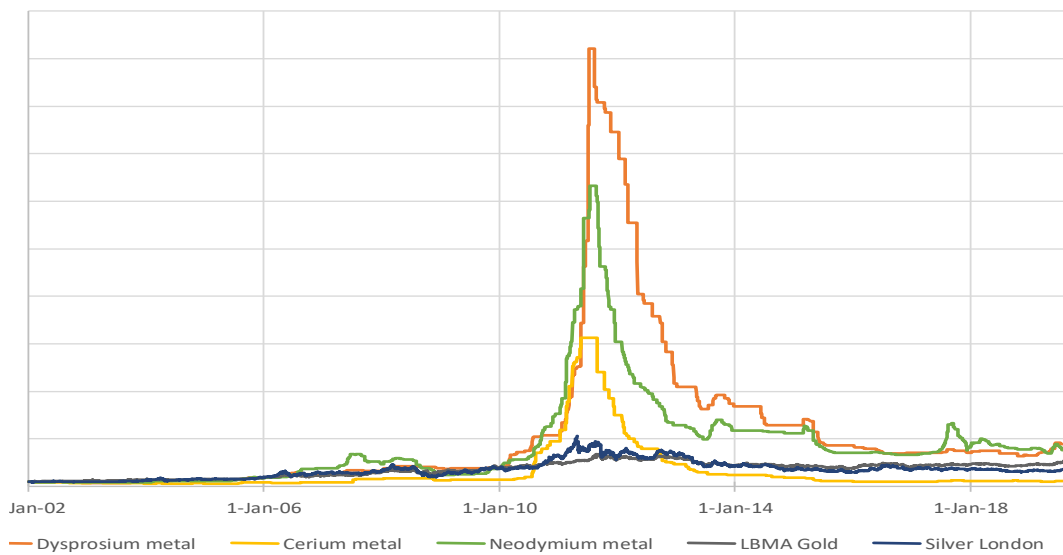

*Unfair Foreign Trade Practices*

Another risk to critical material supply chains involves unfair foreign trade practices that distort global prices and affect the competitiveness of U.S. producers. These include but are not limited to export restrictions

<sup>33</sup> *Ibid.*

that incentivize domestic production and processing; theft of intellectual property, particularly related to processing technology; and export subsidies. The United States enforces a range of U.S. trade laws to address such trade practices both in the United States and at the World Trade Organization (WTO), often in coordination with other trading partners that are similarly affected.

The United States has brought 23 cases against China since its accession to the WTO. Of those, eleven cases were decided in favor of the United States, nine settled via consultation, and the balance are outstanding. Some of these cases have rolled back discriminatory governmental trade practices that provided preferences for China's domestic industry at the expense of foreign buyers, but problematic trade practices persist, including dumping.

"Dumping" generally refers to the practice of exporting a product at a price that is less than the comparable price of a like product in the domestic market. Though costly and data-intensive, several U.S. industry segments have obtained favorable findings under anti-dumping investigations for strategic and critical materials, including duties greater than 140 percent on Chinese magnesium metal exports. China produces about 78 percent of global magnesium, and the United States has a sole-source domestic producer of primary magnesium metal. Magnesium alloys help to reduce the weight of cars, and magnesium-rare earth alloys are essential for certain rotary- and fixed-wing aircraft castings. The former is especially important for traditional, internal combustion engine vehicles to meet increasingly stringent fuel economy standards.

As of April 2021, the United States has more anti-dumping and countervailing duty orders against China than any other nation—215 of 576 orders.<sup>34</sup> Of note, almost 60 percent of these antidumping and countervailing duty orders cover chemicals, steel products, and other metals and minerals.

Other foreign practices also can unfairly depress the prices of strategic and critical materials, thus harming the competitiveness of U.S. producers and their commercial viability. Unfair competitive advantages include lax enforcement of environmental or worker health and safety regulations, as well as government intervention (e.g., sales or purchases) to support national champions. Though China is often cited as a quintessential culprit of unfair trade practices, other countries that produce strategic and critical materials also have pursued such unfair advantages.

## **Risk Factors at the Level of Armed Conflict**

### *National Defense Emergency Scenario Modeling*

As the National Defense Stockpile Manager, DoD undertakes regular economic and scenario-based modeling of strategic and critical material supply chains. The Defense Logistics Agency Strategic Materials (DLA SM) leads this work, offering detailed insights into strategic and critical material markets, and relevant dependencies, under national emergency conditions. The *Strategic and Critical Materials 2021 Report on Stockpile Requirements*<sup>35</sup> is the most recent and final edition, due to the repeal of this reporting requirement pursuant to Section 1061 of Public Law (P.L.) 114-328.

Per the Stockpiling Act, each edition includes alternative, more stressful scenarios in addition to a "base case" military conflict scenario. Given the impact of the COVID-19 pandemic across the global economy, DLA SM included an "alternative case" pandemic study in the 2021 report.

Of the 283 materials monitored or formally assessed for this report, DLA SM identified unclassified base case shortfalls for 53 materials. During a national emergency, the United States is likely to face inadequate supply of these materials due to an inability to access foreign sources, among various other factors. Foreign supply sources include 84 different countries that produce at least one shortfall material:

- 27 countries each produce exactly 1 shortfall material;

---

<sup>34</sup> U.S. International Trade Commission, *Antidumping and Countervailing Duty Orders in Place as of April 14, 2021* (April 2021), [https://usitc.gov/trade\\_remedy/documents/orders.xls](https://usitc.gov/trade_remedy/documents/orders.xls)

<sup>35</sup> This report, including key assumptions related to shipping losses, war damage, and other factors covered by 50 U.S.C. 98h-5, are included in Appendix A.



- 20 countries each produce 2 shortfall materials;
- 16 countries each produce between 3 and 5 shortfall materials;
- 11 countries each produce between 6 and 10 shortfall materials;
- 7 countries each produce between 11 and 20 shortfall materials; and
- 3 countries each produce more than 20 shortfall materials.

Figure 22 contains a list of the 53 unclassified base case shortfall materials, with selected important U.S. application areas or critical infrastructure sectors. Of note, the absence of a shortfall is not necessarily indicative of the absence of supply chain risk. Instead, the zero shortfall result may indicate that (1) DoD was unable to generate sufficiently reliable data to produce modeling results; or (2) the U.S. industrial base may have so atrophied that no U.S. manufacturer is purchasing said strategic and critical materials.

Figure 22: Shortfall Materials and Application Areas

<b>Shortfall Material</b>	<b>Major Application Areas</b>
Aluminum, high purity	Commercial Aircraft
	Combat Vehicles and Tactical Wheeled Vehicles
Aluminum lithium alloys	Commercial Aircraft
Antimony	Pressure Blasting Applications
	Plastics
	Storage Batteries
	Synthetic Rubber
Arsenic, molecular beam grade	Semiconductors and Other Electronic Components
Beryllium ore, beryl ore	Beryllium Hydroxide, Alloys, Oxides, Metals
Beryllium metal	Search, Detection, and Navigation Equipment
Bismuth	Medicinal Chemicals and Botanical Products
	Pharmaceutical Preparations
	Primary Aluminum
Boron-10 (boron isotope) <sup>36</sup>	Nuclear Power
Carbon-Carbon (different types)	Defense applications
Cerium	Motor Vehicle Parts
	Petroleum Refineries
	Glass and Glass Products, Except Containers
	Miscellaneous Manufacturing
	Broadcast and Wireless Communications Equipment
	Explosives and Propellants

<sup>36</sup> The Department of Defense has run only a limited number of isotope supply chains through its modeling process for the National Defense Stockpile program. The Department of Energy maintains robust monitoring of and participation in the isotope market, and at-risk materials are covered in Appendix D and Appendix E

<b>Shortfall Material</b>	<b>Major Application Areas</b>
Energetic Materials <sup>37</sup>	Ammunition Primers and Tracers Demolition and Fuses
Erbium	Optical Instruments and Lenses
Europium	Miscellaneous Manufacturing
Fluorspar, acid grade	Fluorocarbon Air Conditioning
Gadolinium	Pharmaceuticals and Medicines Transportation Equipment Miscellaneous Manufacturing
Graphite, iso-molded civilian grade	Semiconductor machinery Industrial molds
Graphite, iso-molded defense grade	Industrial molds Industrial furnace and oven manufacturing Other defense applications
Lanthanum	Petroleum Refineries Motor Vehicle Parts
Lithium metal	Alloys Batteries Pharmaceuticals
Magnesium metal	Transportation
Manganese metal, electrolytic	Metal Containers, Packaging, Shipping Materials Construction and Building Products Motor Vehicle Parts Electrical and Communications Equipment
Manganese, ferromanganese	Construction and Building Products Motor Vehicle Parts Oil and Gas
Neodymium	Computer Storage Devices Miscellaneous Manufacturing Non-Metallic Mineral Products Transportation Equipment Electronic Components Motors and Generators

<sup>37</sup> Multiple types, see Appendix A and Appendix H

<b>Shortfall Material</b>	<b>Major Application Areas</b>
Niobium	Oil and Gas
	Motor Vehicle Parts
	Aerospace Products and Parts
Praseodymium	Synthetic Dyes and Pigments
	Miscellaneous Manufacturing
	Non-Metallic Mineral Products
	Computer Storage Devices
Rare earth permanent magnets, Neodymium Iron Boron (NdFeB) types	Motor Vehicle Parts
	Industrial Motors
	Magnetic Resonance Imaging (MRI)
Rare earth permanent magnets, Samarium Cobalt (SmCo) types	Consumer Electronics
	Medical Devices
	Electric Motors
Rubber, natural	Tire Manufacturing (except retreading)
Samarium	Electromedical and Electrotherapeutic Apparatus
Scandium	Fuel Cells
Steel, 1080 grade ultra-high strength cable tire cord	Tire Belts and Bead Wire
Steel, grain oriented electrical steel silicon-based	Transformer Laminations
Tantalum	Electronic Capacitors
	Explosively-formed projectiles, warheads
Tin, low alpha	Solders for Electronic Components
Titanium sponge	Aerospace, Commercial
Tungsten	Metalworking Machinery
	Electric Lighting Equipment
Yttrium	Miscellaneous Manufacturing
	Electric Lamp Bulbs and Parts
	Aircraft Engines and Engine Parts
Yttrium (multiple other types)	Semiconductors and Other Electronic Components

#### *Non-Availability of Domestic Stockpiles*

U.S. industry maintains some buffer stocks and other work-in-progress inventories that may offset the impact of a limited supply chain interruption. However, the Federal Government generally has not collected data on

these inventories outside of mandatory assessments by the Bureau of Industry and Security (BIS) at the Department of Commerce, pursuant to Title VII of the DPA.

DoD maintains a stockpile of strategic and critical materials through the NDS, authorized pursuant to the Strategic and Critical Materials Stockpiling Act of 1979 (50 U.S.C. 98 et seq.). Of note, the NDS is a strategic stockpile, not an economic stockpile. As such, the NDS has a deliberately conservative posture and is intended to offset supply chain risk to defense and essential civilian industry from a national emergency event. By contrast, China's State Reserve Bureau is an economic stockpile and is more interventionist in markets, actively combatting price volatility or supporting particular industry segments.

Currently, the NDS Program maintains inventories for 55 materials, with a total value of approximately \$1 billion (Figure 23). DoD funds the operations of the NDS Program from a revolving fund known as the NDS Transaction Fund. As noted in the President's Budget Request for Fiscal Year (FY) 2021 and FY 2020, the NDS Transaction Fund will exhaust all of its resources by FY2024 or FY2025, dependent on (1) the pace at which the NDS Program acquires new materials to mitigate current shortfalls; and (2) the proceeds from the sale of existing stocks.

Figure 23: NDS Program Inventories as of September 30, 2020

Antimony	Lithium Ion – LCO
Beryl	Lithium Ion – LNCA
Beryllium Metal Hot Pressed Powder	Lithium Ion – MCMB
Beryllium Metal Rods	Electrolytic Manganese Metal
Beryllium Metal Vac Cast	Manganese Ferro High Carbon
Beryllium Structural Powder	Manganese Metallurgical Grade Ore
Cadmium Zinc Telluride Substrates	Mercury
Carbon Fibers - PAN	Nickel Alloys
Chromium - Ferro High Carbon	Platinum Group Metals-Iridium
Chromium - Ferro Low Carbon	Platinum Group Metals-Palladium
Chromium Metal	Platinum Group Metals-Platinum
Cobalt	Platinum Group Metal Alloy / Wire
Cobalt Alloys	Platinum Group Metal Compounds - Iridium Alloy
Columbium Metal Ingots	Quartz Crystals
Ferroniobium Low-Alloy-Steel Grade	Silicon Carbide Fibers
Ferroniobium Vacuum Grade	Tantalum Columbium Concentrate
Ferroniobium Stainless-Steel Grade	Tantalum Metal
Dysprosium	Tantalum Alloy
Ferrodysprosium	Tin
Europium Oxide (4N)	Titanium Alloys
Europium Oxide (5N)	Energetic Materials (Multiple Types)
Europium (SEG)	Tungsten Ores & Concentrates

Germanium Metal – Intrinsic	Tungsten Metal Powder
Germanium Wafer	Tungsten Alloys
Germanium Scrap (Coated) (Uncoated)	Tungsten-Rhenium
Iron Alloys	Zinc

The funding deficit for the NDS Transaction Fund is driven by a combination of growing shortfall requirements and legislatively-mandated disbursements from the NDS Transaction Fund to other programs (see Figure 24). From FY2003 to FY2018, Congress diverted 89.8 percent of the proceeds from NDS Program activities, measured in real dollars, to other defense and non-defense programs, such as the Operations & Maintenance accounts of the Military Services, construction of the World War II Memorial, and the Federal Supplementary Medical Trust Fund.

Figure 24: National Defense Stockpile Transaction Fund Distributions

Distribution Type	Total Amount (FY03→FY18) (Real \$2018)	Average Annual Cash Flow (Real \$2018)	Sample Activities / Accts.
<i>To National Defense Stockpile Transaction Fund</i>	\$ 417.3M	\$ 26.0M	<ul style="list-style-type: none"> <li>• Material acquisitions</li> <li>• Qualification of new sources</li> <li>• Metallurgical R&amp;D</li> </ul>
<i>To Non-Defense Accts.</i>	(\$ 998.6M)	(\$ 62.4M)	<ul style="list-style-type: none"> <li>• General Treasury Acct.</li> <li>• American Battle Monuments Commission (World War II Memorial)</li> <li>• Hospital Insurance Trust Fund</li> <li>• Federal Supplementary Medical Trust Fund</li> </ul>
<i>To Other Defense Accts.</i>	(\$ 2,701.5M)	(\$ 168.8M)	<ul style="list-style-type: none"> <li>• Foreign Military Sales Treasury Acct.</li> <li>• Electromagnetic spectrum program</li> <li>• Defense Health Program</li> <li>• MILSVC Operations &amp; Maintenance accts.</li> </ul>
<i>Net Cash Flow to National Defense Stockpile Transaction Fund</i>	(\$ 3,282.8M)	(\$ 205.1M)	

In addition to this inadequacy of funding, the NDS once held many of the materials currently identified in shortfall. For example, the Department of Commerce recently concluded an investigation into titanium sponge under Section 232 of The Trade Expansion Act of 1962, and the interagency Titanium Sponge Working Group is evaluating options to mitigate vulnerabilities in the titanium sponge supply chain, including new stockpile purchases. Unfortunately, the NDS liquidated its stocks of titanium sponge during the post-Cold War sell-off, and now, to the extent possible within existing funding, the NDS Program is increasing its stocks of titanium by recycling it from end-of-life weapon systems. Similarly, the NDS formerly contained approximately 14,000 metric tons of rare earth materials, equivalent to about 7 percent of today's global market. DoD has submitted legislative requests to acquire rare earth materials for the NDS, but Congress has not authorized these purchases.

## OPPORTUNITIES & CHALLENGES

### Challenges to Future Domestic Production

#### *Transparency*

Individual strategic and critical materials markets are often small, with incomplete information on trade flows, production, prices, or inventories. This lack of transparency can involve even the most basic level of information, such as a material's country of origin. For example, sintered NdFeB magnets are the highest value segment of the rare earth market, with a value of about \$10 billion and an estimated production of 160,000 metric tons.<sup>38</sup> The word "estimated" is emphasized because producers and consumers do not report production or consumption data; and although third-party pricing data exists, there is little or no certainty that market participants close their business deals at the published prices. Further, rampant smuggling and illegal mining and processing leaves many market participants unable to trace the origins and chain-of-custody for rare earth materials.

By contrast, the global crude steel market is far larger: approximately 1.8 billion metric tons in 2020.<sup>39</sup> The World Steel Association collects and publishes statistics on the global steel market, and the provision of data is usually a requirement for membership. Similarly, aluminum prices are benchmarked to a global, publicly-available exchange, with local market premiums. Data on production, trade, and price for steel and aluminum is, therefore, highly transparent.

#### *Asymmetric Information*

Due to the small dollar value and the overall product volumes for many strategic and critical material markets relative to other bulk commodities, the number of market participants tends to be very small. This leads to asymmetric information between market participants and outside observers, in which one part of the market obtains an advantage from better or more information than does another part of the market. This asymmetry of information is typified by the volume of press releases and opinion-editorial articles on strategic and critical materials immediately following reported supply chain disruptions. These reports, though well-intended, generally include information on only one aspect of a supply chain, or they are unaware of important developments by government or industry stakeholders.

Asymmetric information is not a lack of information. Rather, the disconnect between actual market activities and the appearance of market activity delays the deployment of private capital to profitable or promising strategic and critical materials projects, resulting in inefficient use of capital. The consequences of asymmetric information can include criminal enterprises convincing investors to buy physical rare earth metal inventories.<sup>40</sup> Rare earth metals are highly illiquid and essentially worthless to private individuals. The perpetrators failed to disclose this risk and leveraged media attention for personal gain.

### Elastic Demand and Inelastic Supply

The operating tempo in strategic and critical materials markets also varies dramatically based on a participant's position in the supply chain. For downstream manufacturers and individual buyers, response times for price fluctuations can be measured from months to a few years. For upstream producers, however, the time to respond can range from years to decades. This gap between elastic demand and inelastic supply in the short-run encourages a very conservative, risk-averse posture in the mining and mineral processing sector.

---

<sup>38</sup> Adamas Intelligence, *Rare Earth Magnet Market Outlook to 2030* (August 2020), <https://adamasintel.com/report/rare-earth-magnet-market-outlook-to-2030/>

<sup>39</sup> World Steel Association, "Global crude steel output decreases by 0.9 percent in 2020," [worldsteel.org](https://worldsteel.org/media-centre/press-releases/2021/Global-crude-steel-output-decreases-by-0.9--in-2020.html) (January 26, 2021), <https://worldsteel.org/media-centre/press-releases/2021/Global-crude-steel-output-decreases-by-0.9--in-2020.html>

<sup>40</sup> Crown Prosecution Service, "Money Launderers Jailed for Role in Rare Earth Metal Scam worth 1 Million Pounds," [cps.gov.uk](https://cps.gov.uk/cps/news/money-launderers-jailed-role-rare-earth-metal-scam-worth-1million) (September 30, 2019), <https://cps.gov.uk/cps/news/money-launderers-jailed-role-rare-earth-metal-scam-worth-1million>

Exemplifying this disconnect is the U.S. lighting industry's transition from tungsten filament lighting products to compact fluorescent, and then to LED products. For decades U.S. tungsten producers enjoyed steady growth — until the emergence of compact fluorescent bulbs. As new homes and offices shifted to this more energy-efficient offering, the U.S. tungsten industry went into decline, including the value-added manufacturing skills needed for wire drawing. Compact fluorescent lighting relies on heavy rare earth elements, such as yttrium and europium. As prices climbed due to tight supply and in anticipation of future growth, producers increased production. However, the same price increases also incentivized the lighting industry to transition from florescent technology to LEDs, which require lesser quantities of heavy rare earth elements. The arrival of new producer capacity, after downstream industry had transitioned to a new technology platform, has contributed to depressed prices for select heavy rare earth elements intended for use by the lighting market, such as yttrium and europium.

Figure 25: U.S. Lighting Sales by Type (2015-2030)<sup>41</sup>

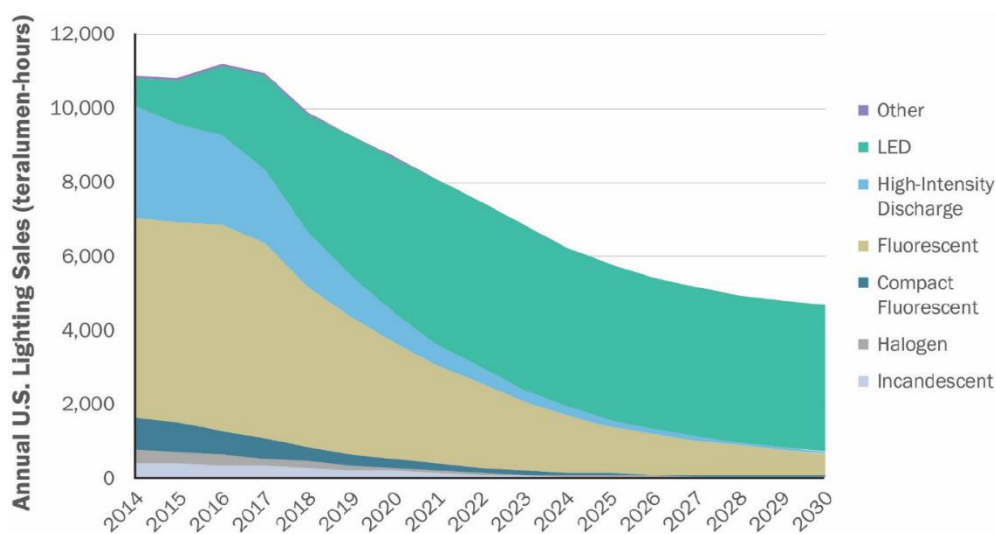

### Small Defense Requirements Relative to Commercial Markets<sup>42</sup>

Even though the U.S. Armed Forces have vital requirements for strategic and critical materials, the essential civilian sector would likely bear the preponderance of harm from a disruption event. This finding is consistent across every modeling excursion by DoD since 2009. The NdFeB magnet market provides an effective illustration of this finding.

A key assumption within DoD modeling of the strategic and critical materials under national emergency conditions is that the U.S. Government will make maximum use of allocation and prioritization authorities pursuant to Title I of the DPA. In brief, if there were a threatened disruption of NdFeB supply, the DoD model assumes that NdFeB materials would be diverted from civilian markets to the defense industrial base. This is similar to the recent diversion of health resources from private sector buyers to Federal Government contracts during COVID-19 pandemic response. Both the Department of Health and Human Services and the Federal Emergency Management Agency deploy these DPA, Title I authorities, respectively, to (1) prioritize direct Federal contracts over private sector and state/local/tribal government purchases of health resources; and (2) require authorization with respect to exports of health resources.

<sup>41</sup> U.S. Department of Energy, *Energy Savings Forecast of Solid-State Lighting in General Illumination Applications* (August 2014), <https://energy.gov/sites/default/files/2015/05/f22/energysavingsforecast14.pdf>

<sup>42</sup> For more detail on this section, see Appendix A.

As regards the NdFeB supply, DoD currently has all necessary authority to place priority ratings, using DPA, Title I, on strategic and critical materials through the Defense Priorities and Allocations System (DPAS) regulation administered by the Department of Commerce. Both the DPAS regulation and the delegation of authority to DoD specifically note that placing priority ratings for stockpiling purchases is permitted, so to the extent that DoD needs to place priority ratings under the DPAS for strategic and critical materials—either for NDS purchases or operational requirements—it has the ability to do so.

The disruption of global supply chains from the scenario and, to a far lesser extent, diversion of supply under DPAS actions is expected to produce very large essential civilian shortfalls — more than ten times DoD’s annual peacetime consumption. Even if DoD limited all of its peacetime NdFeB procurement,

direct and embedded, to a single domestic producer, that arrangement would not be sufficient to hedge the risk to essential civilian industry (see Figure 26), nor would it be sufficient to support even a “moderately” sized NdFeB production facility.

Figure 26: Peacetime Civilian and Defense NdFeB Demand, versus Essential Civilian Shortfalls

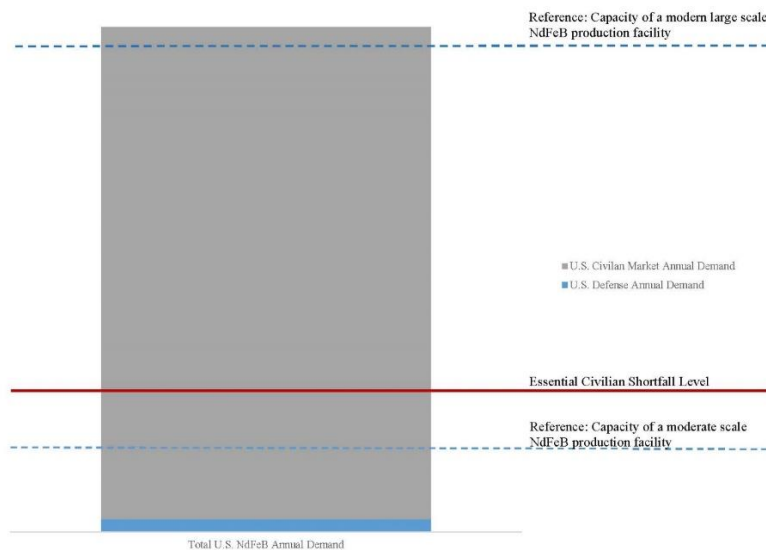

Further, a key difference between the essential civilian market and the defense market is in the form of their respective imports. Both sectors rely on imports, but approximately two-thirds of DoD consumption of NdFeB magnets occurs as *direct demand* of permanent magnet articles. By contrast, 60 percent of essential civilian demand for NdFeB magnets are *embedded demand* in other intermediate or finished goods. DoD’s import posture affords it marginally greater visibility into its foreign reliance compared to other essential civilian sectors, who may not even realize their exposure to an NdFeB magnet disruption since it is several tiers removed from the products they purchase from foreign sources.

Overall, the essential civilian NdFeB shortfall and outsized reliance on embedded demand indicates that a civilian-centric mitigation approach is necessary. DoD and Federal Government activities can act as a catalyst, but absent collaboration with the private sector, government-driven mandates circumscribed to defense procurement will not be sufficient to close the gap between peacetime consumption and postulated national emergency shortfalls.

**Balancing the Need for Additional Supply and Environmental Impact**

Setting aside modeling shortfalls and significant demand expectations for green energy and energy conservation products, the production of strategic and critical material can have significant physical impact (e.g., open pit mining) as well as intense consumption of strong acids and other hazardous chemicals. Recovery of critical materials from environmental legacy sites impacted by acid mine drainage or



impoundments presents an opportunity to pair reclamation efforts with production, turning past industrial waste into the materials needed for green energy products. However, industrial actions often have environmental consequences. In a 2017 report to Congress on the extraction of rare earth elements from coal wastes, the Department of Energy cited six significant environmental challenges:

- Low concentrations lead to processing more material, driving up energy consumption;
- Increased production of fine particular dust, from grinding and crushing operations;
- Potential production of large volumes of liquid and solid wastes;
- The toxic and caustic nature of chemical reagents required for extraction;
- Processing operations may create concentrations of radionuclides; and
- If using current waste piles, extraction of rare earth elements could shift ownership of the long-term environmental liability associated with the waste pile and levy new waste management standards not otherwise applicable if the waste pile is left undisturbed.<sup>43</sup>

The Department of Energy is addressing the environmental concerns identified in this 2017 report, and their research efforts have demonstrated the technical feasibility for producing critical materials from unconventional sources, optimizing many of the challenges cited in this prior work. Continued research in this area is essential to minimize the environmental impact of using unconventional sources or particularly in regions that are economically distressed, affected by energy transitions, or harmed by adverse environmental impact from the strategic and critical materials industry. More specific waste characterization and business case analysis also will be required as this bench-scale test work advances into pilot studies.

In-process and post-consumer recycling of strategic and critical materials often supplement primary production, and recycling is a key component of the U.S. Government's approach to mitigating strategic and critical materials risk. For example, DoD has consistently sought to identify and then mature promising technologies for NdFeB magnet collection and uptake. From 2016 to the present, DoD has invested approximately \$30.7 million in NdFeB magnet recycling, first through Small Business Innovation Research (SBIR) awards, followed by scale-up capital from Title III of the DPA.

Through this process, DoD and our non-defense agency partners, who assist with program management reviews, have identified several challenges to increased recycling of strategic and critical materials:

- Like coproduct or byproduct dependency, recycling of strategic and critical materials often depends on the recovery of another metal with high intrinsic value, such as gold;
- Take-back and collection schemes for end products containing strategic and critical materials are highly variable, ranging from non-existent to completely closed systems in which end items must be returned to the original manufacturer;
- End products often are not designed for recycling (e.g., use adhesives and other proprietary fastening devices, lack of labeling for processing and consumer awareness of recyclability, and use of hazardous materials or materials that become hazardous waste at EOL) increase the cost of recycling; and
- State and local regulations for take-back and collection of end-items (e.g., consumer electronics) containing strategic and critical materials are highly variable.

## **Opportunities to Resume Strategic and Critical Materials Production**

In support of this assessment, DoD posted a *Federal Register* Notice of Inquiry, soliciting public comments from any interested stakeholders. DoD received over 100 comments, supplemented by business proprietary

---

<sup>43</sup> U.S. Department of Energy, *Report on Rare Earth Elements from Coal and Coal Byproducts* (January 2017), [https://www.energy.gov/sites/prod/files/2018/01/f47/EXEC-2014-000442\\_percent20-percent20for\\_percent20Conrad\\_percent20Regis\\_percent202.2.17.pdf](https://www.energy.gov/sites/prod/files/2018/01/f47/EXEC-2014-000442_percent20-percent20for_percent20Conrad_percent20Regis_percent202.2.17.pdf)

data submissions as well as bilateral and multilateral engagements with U.S. allies, partners, and other foreign governments.

DoD also participated in small group discussions with key participants representing upstream and downstream industry, large and small businesses, environmental justice advocates, academia, and consultants to U.S. and foreign industry leaders. DoD held some of these discussions under “Chatham House Rule” in an effort to solicit a frank exchange of views on the challenges in the strategic and critical materials sector and possible approaches to mitigating them.

In the course of DoD’s stakeholder engagements, there is a clear— if not unanimous— consensus that environmental-social-governance (ESG) reporting and low-carbon strategic and critical materials production is a real and strengthening market force. However, there also is a consensus that the strategic and critical materials market does not yet place a premium on a “sustainably produced” strategic and critical material, with limited exceptions.

Sustainability, as a value proposition to support production and post-consumer recycling, has the potential to structurally change strategic and critical material markets which, heretofore, have largely focused on cost — be it the cost of production or imposing trade barriers to increase the cost of imports. Moreover, numerous industry groups and non-governmental organizations already have set a strong foundation for responsible sourcing of strategic and critical materials. Each of these standards differ, participation is voluntary, and implementation is uneven within specific strategic and critical material markets and across jurisdictions.

Taken together, this untapped market demand for sustainably-produced strategic and critical materials presents an opportunity for the U.S. Government to reward “good” behavior, while relying on natural market forces to push bad actors towards improvement or exiting the market. Ultimately, the approach implemented by the Federal Government will be bespoke to the particular challenges associated with each strategic and critical material and its market, with a sample included in Appendix C.

## **RECOMMENDATIONS**

Reliable, secure, and resilient supplies of key strategic and critical materials are essential to the U.S. economy and national defense. The United States needs an “all of the above” comprehensive strategy to increase the resilience of strategic and critical material supply chains that both expands sustainable production and processing capacity and works with allies and partners to ensure secure global supply. We recommend a strategy centered on the following:

### **1. Developing and Fostering New Sustainability Standards for Strategic and Critical Material-Intensive Industries.**

As detailed in this report, the global race to the bottom in search of lowest-cost production has led to the proliferation of critical mineral extraction, processing, and recycling operations in locations with weak environmental regulations, labor standards, and governance. As the world-leading developed economy, the United States can drive global market change towards the value of environmentally and socially responsible production.

The private sector and Federal agencies that purchase strategic and critical materials and end-items containing these materials generally do not evaluate the complete environmental, social, and related risks associated with unsustainable production practices. The U.S. Government, working in partnership with the private sector and other stakeholders, should encourage the development of new sustainability standards for designated strategic and critical materials to conduct due diligence, eliminate sources of unsustainable production, and accelerate Federal and commercial purchasing of sustainable products. A recognized sustainability standard, potentially backed by legislation, and coordinated with trading partners, would encourage private sector investment in sustainable sources and increase supply chain resilience.

- *Develop Sustainably-Produced Content Standards for Strategic and Critical Material-Intensive Industries*

The U.S. Government should work with key stakeholders from the private sector, labor, and non-governmental organizations (NGOs) to develop easy to understand sustainability metrics for designated critical minerals and other critical materials. In the near term, this initiative should begin as a public-private partnership focused on a handful of materials essential to the U.S. economy. Over time, the Executive Branch should work with Congress to provide the authority to develop and promulgate regulations that would support the use of “sustainably produced” strategic and critical materials from domestic and foreign sources.

Sustainability standards should be particularly applicable to those sectors that drive U.S. consumption, particularly automotive and aerospace products, fuel production, power generation and distribution, and electrical and electronic products. New products and materials should be added as necessary to conserve and promote the sustainability of strategic and critical materials.

The definition of “sustainability” should be developed through a collaborative process between the Administration and other interested stakeholders. The scope of “sustainability” should ensure strong environmental standards throughout the mining lifecycle; corruption prevention; worker health and safety; the strength of local governance; consultation with potentially impacted tribal and indigenous communities; eliminating forced, indentured, or child labor; and transparency. Within the Federal Government, responsibility for the technical development of this standard should be co-led by the Department of Energy and the Environmental Protection Agency, with support from other relevant agencies (such as the Departments of Commerce, Interior, and Transportation) and external stakeholders as appropriate.

As uniform product labelling is essential to informed consumer choice, an element largely absent in strategic and critical material markets today, the U.S. Government should encourage a clear and uniform labelling standard for sustainably produced critical minerals and materials. The U.S. Government should also work with allies and partners, including through international standards-setting bodies, to promote international adoption of sustainability standards for designated strategic and critical materials.

- *Establish U.S. Government Procurement as a Sustainability Leader*

Though Department of Defense and other U.S. Government purchases will not be sufficient to serve as an “anchor” customer for most sustainably-produced end-items, adoption of a sustainability requirement for U.S. Government purchasing will act as an important signal to the market. Upon development of a “sustainably produced” standard, the U.S. Government should direct the Federal Acquisition Regulatory Council to publish a rule for public comment that would establish a preference or requirement for the selection of products with higher sustainably-produced content.

## **2. Expanding Sustainable Domestic Production and Processing Capacity, Including Recovery from Secondary and Unconventional Sources and Recycling**

As identified in this report, the United States faces weaknesses in both the production and the processing of a range of strategic and critical materials. In addition to demand-side commitments, the U.S. Government should incentivize domestic and foreign production, processing, and recycling of strategic and critical materials, ensuring that they adhere to strong environmental standards, meaningful community consultation including government-to-government consultation with Tribal Nations, and strong labor standards. Expanding U.S. production and processing capacity will require investments in mining, including in non-traditional types of mining, in processing, and in recycling. To the greatest extent possible, new processing and recycling investments should prioritize locations with economic development and high-quality job creation opportunities for communities impacted by mining and the transition to a low-carbon economy.

- *Build a Foundation for Accelerated Growth in Strategic and Critical Material Recycling*

Recycling is one of the original green technology industries in the United States. There is tremendous opportunity for the private sector to grow strategic and critical material recycling as hybrid-electric and full electric vehicles, as well as other emerging technologies, reach end-of-life (EOL). This could include strategic and critical materials in lithium-ion batteries (nickel, cobalt, lithium, others) and electric motors (rare-earth elements).

The Federal Government, particularly the Environmental Protection Agency, should play a foundational role in decreasing market barriers to recycling in the United States by providing recommendations and guidance to State and local governments to create uniform collection procedures for EOL items containing strategic and critical materials, such as electric vehicle batteries. Developing a strong, uniform national standard for end of life recycling would be a no-cost approach to supporting the development of closed-loop recycling processes (see Figure 27 for the variance in State recycling laws related to batteries). The Administration should work with Congress to develop legislation to unify collection procedures for these EOL items.

Figure 27: U.S. Battery Laws by State<sup>44</sup>

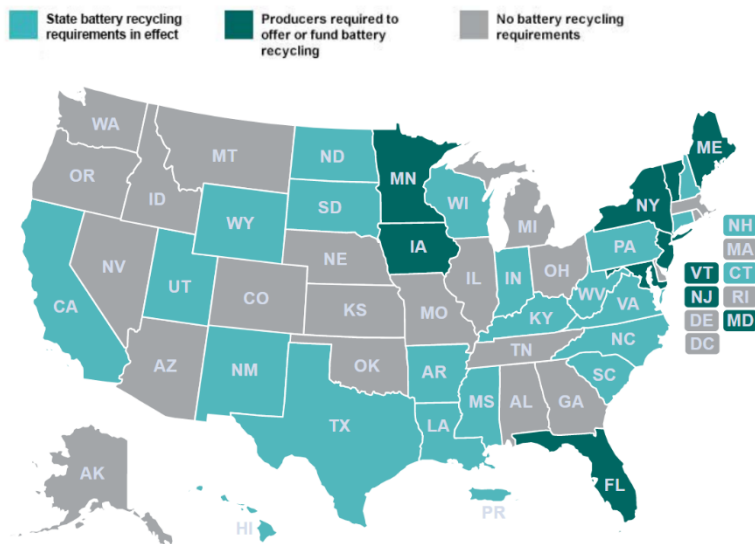

There are multiple other areas in which the Federal Government should support recycling opportunities. For example, the Federal Government should encourage key industry sectors (e.g., consumer electronics) to adopt industry standards related to designing products to be more readily recyclable. A second area of support should include R&D support to develop technologies that isolate and increase concentrations of strategic and critical materials in EOL waste streams. Department of Defense and the Department of Energy should continue to provide R&D incentives for industry to develop, pilot, and deploy technologies that automate removal of rare earth magnets and other strategic and critical material-containing components from EOL items, such as hard disc drives, cell phones, and other small devices.

The Federal Government should work with industry through public-private partnerships to establish standards for the requalification of strategic and critical materials and related components for reuse. This would enable like-for-like reinsertion into the supply chain or “down-cycling” to other supply chains, if reclaimed materials do not maintain sufficient performance in the original end-item.

<sup>44</sup> Call2Recycle, “Recycling Laws By State” (2021), [call2recycle.org, https://call2recycle.org/recycling-laws-by-state/](https://call2recycle.org/recycling-laws-by-state/)

The Federal Government should also lead by example by establishing a government-wide recycling program to reclaim strategic and critical materials. For example, the U.S. Government operates more than 4,000 data centers, which represent a near-term opportunity to leverage Federally-funded R&D to recycle rare earth permanent magnets from hard disk drives.<sup>45</sup>

- *Collaborate with the States, Tribal Nations, and Non-Governmental Organizations on Reclamation of Mining Waste*

The Federal Government has a long history of working with States, Tribal Nations, and NGOs on mine remediation, reclamation and restoration. However, these efforts center on individual projects; there is no unified national strategy to accelerate and coordinate these efforts, nor do these efforts evaluate potential resources within mine wastes at abandoned or other active mining sites.

As part of a material-by-material strategy to secure a domestic supply, secondary and unconventional sources should be prioritized to provide new, near-term sources of supply and reduce the need for new conventional extraction. The U.S. Geological Survey's Energy, Minerals, Environmental Health, and National Land Imaging programs and partners have identified several recommendations to support the development of such a strategy, while helping resource management agencies weigh the benefits and risks of reprocessing, reclaiming, and restoring mine waste sites. These include:

- Accelerating development of a national mine waste inventory by the U.S. Geological Survey, other Department of Interior offices, U.S. Department of Agriculture, Environmental Protection Agency, and State agencies, including site prioritization and coordination of data collection, and grants to universities and States;
- Supporting demonstration projects to reprocess, reclaim, remediate and restore abandoned mine wastes; and
- Creating and staffing a Federal Advisory Committee (FAC) to bring together Federal, State, Tribal, and private sector actors and, in tandem, create a Federal interagency body that works with the FAC to understand and focus efforts on the environmental and community impacts of mine wastes and effective remediation and reclamation strategies, including opportunities for reprocessing, economic development, and workforce opportunities for former mine workers and mining communities.

- *Identify and Spotlight U.S. Sustainable Resource Production Opportunities*

The United States' non-fuel mineral resources are significantly under-mapped relative to those of other developed nations; only 12 percent of U.S. territory has modern high-resolution geophysical surveys of the subsurface, and only 35 percent is covered by detailed geologic mapping of the surface and near-surface.

By statute, the U.S. Geological Survey's National Minerals Information Center within the Mineral Resources Program collects information on mining and mineral processing, through to metal and alloy production. These data on the "above-ground" portion of the nation's mineral resource base provide a foundation for significant bodies of analysis on supply chain risks, but significant gaps in information still exist.

Moreover, the Department of the Interior should seek expanded funding and full staffing for the U.S. Geological Survey's Mineral Resources Program, including the National Minerals Information Center (NMIC). NMIC funding has declined by 37 percent in real dollars over the past 25 years, notwithstanding its outsized contributions to economic modeling and geological assessments by the

---

<sup>45</sup> U.S. Government Accountability Office, *Data Center Optimization, Continued Agency Actions Needed to Meet Goals and Address Prior Recommendations* (May 2018), <https://www.gao.gov/assets/gao-18-264.pdf>

U.S. Government. Furthermore, though NMIC is authorized 168 full-time equivalents (plus contractors), available funding has never enabled NMIC to staff-up to full strength (see Figure 28).

Figure 28: Appropriations and Staffing for Department of the Interior's USGS National Minerals Information Center (\$2021)

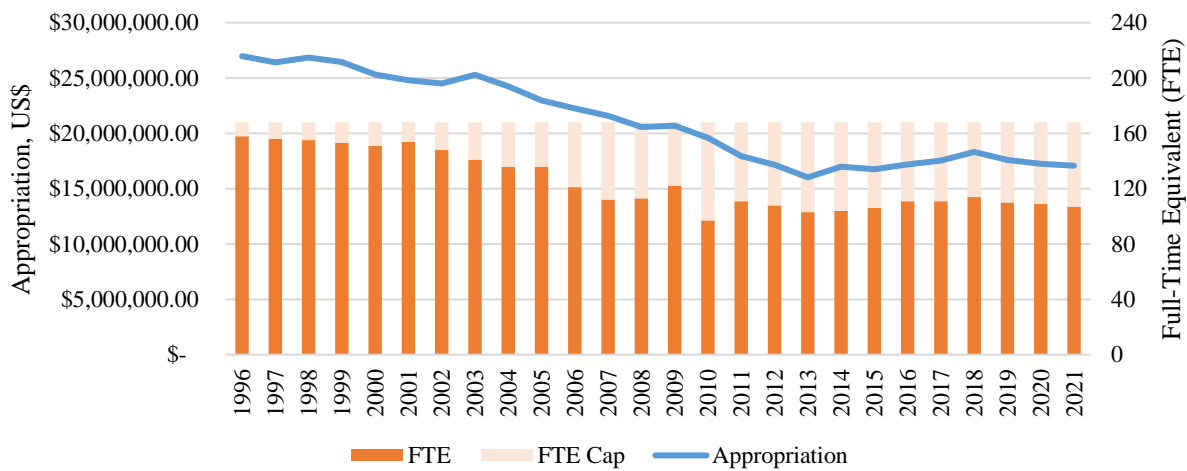

The Geological Survey and the major U.S. public lands agencies, the Department of the Interior and the Department of Agriculture, also should establish a new interagency task force to develop a material-by-material plan to identify specific locations of key strategic and critical materials in the United States that could be sustainably produced domestically. This task force should include the Environmental Protection Agency and consult with other key stakeholders, to ensure that such resources can be extracted while meeting the highest environmental, Tribal Nation consultation, and labor standards.

### 3. Deploy the DPA and Other Programs

Title III of the DPA gives the President the authority to issue grants, loans, loan guarantees, and other economic incentives to establish industrial capacity, subsidize markets, and acquire materials. Though DoD executes investments under the authority of Title III of DPA consistent with its duties as the DPA Fund Manager,<sup>46</sup> any Federal Agency responsible for a critical infrastructure<sup>47</sup> sector may request the use of DPA to mitigate current or estimated shortfalls to national defense.<sup>48</sup>

As highlighted multiple times throughout this report, the essential civilian sectors of the U.S. economy bear the brunt of risk and vulnerability related to potential supply disruptions of strategic and critical materials. The use of DPA and other authorities also has the potential to spark private sector investment and send a strong signal to market participants.

The Departments of Energy, Commerce, Interior, and Defense should use DPA and other existing authorities and funding to incentivize production across the supply chain, including downstream, high value-added manufacturing such as new magnet capabilities and advanced electric motor designs.

<sup>46</sup> White House, E.O. 13603 *National Defense Resources Preparedness* (March 16, 2012), <https://obamawhitehouse.archives.gov/the-press-office/2012/03/16/executive-order-national-defense-resources-preparedness>

<sup>47</sup> As established by White House, *Presidential Policy Directive – Critical Infrastructure Security and Resilience* (February 12, 2013), <https://obamawhitehouse.archives.gov/the-press-office/2013/02/12/presidential-policy-directive-critical-infrastructure-security-and-resil>

<sup>48</sup> “National defense” is defined in 50 U.S.C. 4552 to mean: programs for military and energy production or construction, military or critical infrastructure assistance to any foreign nation, homeland security, stockpiling, space, and any directly related activity. Such term includes emergency preparedness activities conducted pursuant to title VI of The Robert T. Stafford Disaster Relief and Emergency Assistance Act [ 42 U.S.C. 5195 et seq.] and critical infrastructure protection and restoration.

Agencies also should use DPA, Title III and similar programs to support proven R&D capacities and emerging technologies, particularly those developed by small businesses through the SBIR and Small Business Technology Transfer (STTR) programs. The Department of Defense's work to develop, mature, and scale rare earth magnet recycling capabilities with a U.S. small business and engineering studies related to heavy rare earth oxide separation through the IBA S program demonstrate this commitment to bridge the "Valley of Death" from late-stage research to full-rate production.

DoD has recently used DPA, Title III authorities to make investments in domestic strategic and critical material processing operations, specifically in rare earth elements. Similarly, the Department of Energy operates two loan programs, pursuant to the Energy Policy Act of 2005 (Public Law 109-58) and the Energy Independence and Security Act of 2007 (Public Law 110-140), which can support domestic production of critical minerals.<sup>49</sup>

DPA, Title III and similar authorities should be used to support domestic production in sustainable production and processing operations, like the greenhouse gas reduction, financial, and end-use requirements of the Department of Energy loan program. When the Federal Government is responsible for incentivizing domestic production, the Government should take additional measures (beyond complying with sustainability standards) to ensure that the mining occurs in an environmentally and socially protective manner over the entire mining lifecycle through reclamation and closure. Initial recommendations include:

- Conditioning economic incentives to applicants with strong past performance on environmental compliance at current or previous operations or applicants bringing environmental best-practices to legacy operations;
- Providing incentives only for applicants that can demonstrate up-front financial assurance for full site reclamation and closure.
- Providing incentives only for mines in U.S. states that have strong mining environmental regulations and enforcement and compliance programs.
- Ensuring regular environmental inspections in the course of awardee performance, to validate compliance with Federal permits and approvals.
- Requiring strong labor protections, including prevailing wage requirements, use of Project Labor Agreements and community hire on construction projects, union neutrality policies for employers, and a ban on mandatory arbitration agreements, as relevant to the proposed scope of work.
- Requiring goods and materials to be made in the United States and shipped on U.S.-flag, U.S.-crewed vessels.

#### **4. Convene Industry Stakeholders to Expand Production**

Title VII of the DPA provides authorities that the interagency can deploy today to support requirements generation and definition, such as the mandatory survey authority of the Department of Commerce in 50 U.S.C. 4555. Non-availability of data remains a significant constraint to effective mitigation programs in the strategic and critical materials sector, and so those agencies with information collection requirements, such as

---

<sup>49</sup> Loans Program Office (Department of Energy), "Notice of Guidance for Potential Applicants Involving Critical Minerals and Related Activity," *Federal Register* 85 No. 231 (December 1, 2020), 77202-77203, <https://www.federalregister.gov/documents/2020/12/01/2020-26407/notice-of-guidance-for-potential-applicants-involving-critical-minerals-and-related-activity>

mining production surveys by the Geological Survey or industrial base analyses by DoD, should engage the Department of Commerce to deploy this authority to mitigate data gaps.

Title VII of the DPA also authorizes the Federal Government to convene industry, with protection from civil and criminal anti-trust law, to coordinate business activities and form plans of action that satisfy a national need (50 U.S.C. 4558). The U.S. Government should use these authorities to convene a government-industry working group to identify opportunities to expand sustainable domestic production, and explore opportunities to create consortiums or public-private partnerships for sustainable domestic processing of key strategic and critical materials.

### **5. Promote Interagency Research & Development to Support Sustainable Production and a Technically-Skilled Workforce**

Though significant research and development efforts have been underway to address critical and strategic material supply chain risks over the past decade, these have been largely limited to early-stage research and development past the stage of mining. The Energy Act of 2020, as incorporated into the Consolidated Appropriations Act, 2021 (Public Law 116-260) provides additional authorization for the Department of Energy to expand critical material R&D efforts to include demonstration and commercialization. Congress should fully fund and resource these programs.

A coordinated interagency approach to R&D should prioritize the laboratory-to-market transition for emerging technologies in the area of sustainable production. The Departments of Defense and Energy and other Federal agencies should signal their commitment and interest in U.S. innovation by establishing stronger links between early stage research, DPA, Title III grants, loans and incentives, as well as non-competitive awards through SBIR and STTR Phase III legislative authority for commercialization. DPA, Title III, when evaluating applicants, gives preference to small businesses.

Similarly, multiple agencies invest substantial resources in workforce training. This includes, but is not limited to, the Departments of Education, Labor, Defense, Veterans Affairs, and the National Science Foundation, with supporting investments with universities in R&D. Timely investments by such agencies in technical training and education will be essential to ensure that all other investment-driven recommendations can be implemented—from mine engineering to sustained research in ecologically sustainable modes of production.

The Departments of Education and Energy, in coordination with other agencies as appropriate, should conduct a joint study with a federally-funded R&D center to evaluate the development and programmatic operationalization of a fully-integrated education and R&D center, consistent with fiscal law, for sustainable strategic and critical materials development. This will enable more efficient transfer and execution and linkage of R&D, education, and workforce training funds from across the interagency to address whole-of-nation needs.

### **6. Strengthen U.S. Stockpiles**

National stockpiles can play a key role in supply chain resilience by providing a buffer against short-term supply disruptions or bridging the gap between peacetime and full industrial mobilization. However, U.S. stockpile authorities and funding have not kept up with needs.

As noted in this report, Congress diverted approximately \$3.3 billion (2018) and approximately \$1 billion (2018) of NDS Program revenue to other defense and non-defense programs. Although Congress has ceased those transfers, the NDS Program will exhaust all of its current resources within the Future Years Defense Program (FYDP). To sustain operations, the NDS is compelled to sell currently stockpiled materials for which the Department of Defense and essential civilian industry have shortfall requirements. More generally, due to a lack of available funding, less than 10 percent of postulated wartime material shortfalls are estimated to be mitigated.

DoD's flagship authority for the evaluation of risk in strategic and critical materials supply chains flows from the Strategic and Critical Materials Stockpiling Act (50 U.S.C. 98 et seq.). Though Congress has made small



adjustments to the statute since the end of the Cold War<sup>50</sup>, the last overarching review and reform occurred in 1979, and in the intervening years, delegations of authority from the President to DoD have not kept pace with the reorganization of the Office of the Secretary of Defense.<sup>51</sup> Many of the recommendations from the last systemic review of DoD stockpiling activities—more than two decades ago—have not been implemented.<sup>52</sup>

First, the President should issue an E.O. delegating existing authority for the release of NDS materials for use, sale, or other disposition, pursuant to 50 U.S.C. 98f. Notwithstanding congressional authorization for this delegation through Public Law 112-239, no such delegation has been made.

Further, DoD should seek new legislation to recapitalize and modernize the NDS Program, including the following actions:

- Obtain new appropriations for the NDS, totaling not less than \$1 billion over the next FYDP to sustain operations;
- Reinstate the reporting requirement for biennial modeling and simulation of strategic and critical material supply chains under national emergency conditions (50 U.S.C. 98h-5);
- Grant the NDS the authority to purchase strategic and critical materials currently identified in shortfall (e.g., rare earth elements);
- Grant the NDS the authority to “loan” material from Federal Government stocks to U.S. private industry, DoD Components, or other Federal agencies to mitigate peacetime disruption risk;
- Grant the NDS the authority to purchase strategic and critical materials, for actions less than \$50M, without congressional authorization; and
- Obtain appropriate direct-hire authority or other relevant authorization for the recruitment, retention, and incentive pay for highly-qualified personnel to staff the NDS program and related national emergency preparedness and mobilization programs, such activities under the DPA.

## **7. Work with Allies and Partners and Strengthen Global Supply Chain Transparency**

Though increasing U.S. production is a key part of a resilient strategic and critical materials supply chain, the United States also must work with allies and partners to strengthen collective resilience. The United States should pursue several steps to do this:

- *Engage Trading Partners and Emerging Markets to Ensure Reliable Supplies and Improve Governance*

Through the Department of State and the Office of the U.S. Trade Representative, the United States should engage with like-minded foreign producers of strategic and critical materials to promote a value-based approach as they consider approaches to sustainability—rather than one focused on cost-imposition—and encourage alignment of U.S. and foreign product sustainability standards.

The Department of State should use government-to-government fora and related collaborative networks, such as the Energy Resources Governance Initiative (ERGI)<sup>53</sup> or the Extractive Industries

---

<sup>50</sup> Such as the addition of “single point of failure” analysis via P.L. 104-201.

<sup>51</sup> Ronald Reagan, E.O. 12626, “National Defense Stockpile Manager,” February 25, 1988, <https://archives.gov/federal-register/codification/executive-order/12626.html>

<sup>52</sup> U.S. Government Publishing Office, “Proposed Reconfiguration of the National Defense Stockpile,” *Hearing before the Readiness Subcommittee of the Committee on Armed Services, (U.S. House of Representatives, July 23, 2009*, <https://govinfo.gov/content/pkg/CHRG-1111hrg52723/pdf/CHRG-1111hrg52723.pdf>

<sup>53</sup> Founding members of ERGI include the United States, Australia, Botswana and Peru.

Transparency Initiative (EITI), to build foreign capacity to implement and oversee sustainable practices in the strategic and critical materials sector. The Department of Energy-led trilateral agreement between the United States, Japan, and the EU, as well as bilateral engagements with Canada and Australia via the Department of State, are model examples for international cooperation on strategic and critical materials. These efforts should continue and, as appropriate, additional engagements should be undertaken.

ERGI, led by the Department of State, promotes sound mining sector governance and resilient energy mineral supply chains. This initiative brings countries together to advance governance principles, share best practices, and encourage a level playing field for investment. The Founding Partners of ERGI also have developed an online toolkit, free and open to the public, as a unique resource for governments interested in sound governance and regulation of their extractive industry sector.

The Initiative for Responsible Mining Assurance (IRMA) is an international coalition of businesses, nongovernmental organizations, labor unions, mining operators, and other stakeholders that has developed a Standard for Responsible Mining and established a system for independently certifying mines worldwide that adhere to that standard. IRMA may provide a method for U.S. companies and the federal government to ensure that minerals are being sourced from mines with robust environmental, social, and financial responsibility policies, and also could provide a model for responsible development of additional mines in the United States.

- *Incentivize Sustainable Production by Allies and Partners*

Multiple agencies of the U.S. Government can support the sustainable production and processing of critical minerals and other materials in U.S. allies and partners. The Export-Import Bank of the United States (EXIM) should provide loans or loan guarantees to support the export of U.S. mining equipment and engineering services. The U.S. International Development Finance Corporation (DFC) is uniquely positioned to invest in bankable projects in the strategic and critical materials sector in emerging markets with its debt, equity and political risk insurance products, and should pursue such opportunities.

This type of financing support, implemented in accordance with strong, internationally recognized environmental and social standards, should improve local development of strategic and critical materials extraction and value-added manufacture in accordance with sustainability goals and ease the path to compliance for developing nations. Materials experts across the U.S. Government should provide technical guidance to EXIM and DFC to assist them in assessing a potential project's sustainability and benefits to supply chain resilience.

- *Support Increased Transparency in Materials Supply Chains*

Supply chain transparency for strategic and critical materials, including critical minerals, is of great importance for U.S. objectives. Responsible mineral supply chains should be transparent in their methods and origins, traceable, and pursue best practices with respect to labor and human rights, the environment, and other criteria. The United States has continued to work on a variety of initiatives that support these complex and reinforcing areas of commerce. We recommend deepening and expanding U.S. policy efforts in these areas by the actions outlined below:

- The Department of State should recommit the United States to the EITI. Though the United States maintains strong financial support for EITI, a public recommitment to its objectives will have an important impact on producing states.
- The SEC should review compliance with Dodd-Frank 1502 and the rule promulgated thereunder, issuing enforcement actions as appropriate. The Department of State develop a spend plan to fully-resource its supply chain transparency and governance initiatives. Section

1502 drove a global movement in minerals supply chain transparency by forcing an entire market to map supply chains for conflict minerals to try to break the link between armed groups and these materials in the Democratic Republic of the Congo and the African Great Lakes Region.

- The Department of State should seek new authority from Congress to expand Section 1502 beyond the African Great Lakes Region to other conflict-affected and high-risk areas. This expansion would mirror global compliance trends, such as those planned in the EU.
- The Department of Treasury, Department of Homeland Security, and the Department of State, with collaboration from other Federal agencies as appropriate, should build a coalition of stakeholders, financiers, and practitioners to develop innovative solutions to increase transparency throughout supply chains from mining to finished product delivery in materials with a high risk for human rights abuse and corruption.
- The Department of State, the Department of Justice, the Department of Homeland Security, and the Department of the Treasury should develop a spend plan to (1) fully-resource and staff their activities to trace strategic and critical material supply chains, investigate money laundering, corruption, links to organized crime, and human rights abuses; and (2) implement the appropriate mix of civil, criminal, and administrative enforcement actions.
- The President should direct the Attorney General and the Secretaries of State, Treasury, Homeland Security, Department of Labor to provide periodic updates to the National Security Council and the National Economic Council on strategic and critical material due diligence laws, industry best-practices, and recommendations— to include new legislation— to reduce the impact of forced labor, organized crime, and other human rights abuses in strategic and critical material supply chains.

## ABBREVIATIONS

BIS - Bureau of Industry and Security, Department of Commerce  
USBM - Bureau of Mines, a now-closed component of the Department of Interior  
DFARS - Defense Federal Acquisition Regulation Supplement  
DLA SM - Defense Logistics Agency Strategic Materials, Department of Defense  
DPAS - Defense Priorities and Allocations System, under Defense Production Act  
DPA - Defense Production Act  
DRC - Democratic Republic of the Congo  
DoD - Department of Defense  
EOL - End-of-Life  
ERGI - Energy Resources Governance Initiative  
ESG - Environmental Social Governance  
EU - European Union  
ERECOM - European Rare Earth Competency Network  
E.O. - Executive Order  
EXIM - Export-Import Bank of the United States  
EITI - Extractive Industries Transparency Initiative  
FAC - Federal Advisory Committee  
FY - Fiscal Year  
FDI - Foreign Direct Investment  
FYDP - Future Years Defense Program  
GDP - Gross Domestic Product  
IBAS - Industrial Base Analysis & Sustainment  
IRMA - Initiative for Responsible Mining Assurance  
IEA - International Energy Agency  
LEDs - Light Emitting Diodes  
MRI - Magnetic Resonance Imaging  
NDS - National Defense Stockpile  
NEPA - National Environmental Policy Act  
NMIC - National Minerals Information Center  
NSTC - National Science and Technology Council  
NTIB - National Technology and Industrial Base  
NdFeB - Neodymium Iron Boron  
NiMH - Nickel Metal Hydride  
NGO - Non-Governmental Organization  
OECD - Organization for Economic Cooperation and Development  
R&D - Research and Development  
SEC - Securities and Exchange Commission  
SBIR - Small Business Innovation Research  
STTR - Small Business Technology Transfer  
SMART - Strategic Materials Assessment and Risk Topography  
SOFC - Solid Oxide Fuel Cell  
TREO - Total Rare Earth Oxide  
TVPRA - Trafficking Victims Protection Reauthorization Act list  
VAT - Value-Added Tax  
WTO - World Trade Organization  
YSZ - Yttrium-stabilized zirconia  
3TG - Tin, Tantalum, and Tungsten





**REVIEW OF PHARMACEUTICALS AND ACTIVE  
PHARMACEUTICAL INGREDIENTS**

**DEPARTMENT OF HEALTH AND HUMAN SERVICES**

## EXECUTIVE SUMMARY

Keeping the Nation's drug supply chain secure, robust, and resilient is essential for the national security and economic prosperity of the United States. A robust pharmaceutical supply chain has at least three critical features: 1) the ability to manufacture high-quality products for the U.S. market; 2) diversification of the drug supply chain, such as relying on a geographically diverse set of manufacturers; and 3) redundancy of the supply chain, such as the existence of multiple manufacturers for each product and its precursors. A nimble structure that is flexible enough to change volumes and products in response to supply and demand is also important for a robust supply chain. As this report details, the pharmaceutical supply chain is complex, global, and vulnerable to disruptions.

The stability and resilience of the drug supply chain are highly influenced by market factors that have led to increasing reliance on foreign countries to manufacture the medicines, active pharmaceutical ingredients (APIs) and their key starting materials (KSMS) that serve the American public. Vast multinational supply chains and complex production and distribution paradigms can all contribute to disruptions in crucial steps in the supply chain that increase the risk of a drug entering shortage and other consequences of disruption such as quality concerns.

Market factors, such as cost pressure, play a role as well, as they tend to decrease diversification, redundancy, and investment in newer quality systems. Over the past 30 years, the generic pharmaceutical market, which accounts for 90 percent of the drugs prescribed to Americans, has consolidated and increasingly outsourced its production to countries with lower labor and manufacturing costs in response to low profit margins. Production domestically is largely not competitive due to factors such as higher labor and other costs of production, including environmental and occupational codes. In addition, concentration in the pharmaceutical distribution market drives negotiating power for intermediaries, resulting in lower retail costs to final consumers, but also in lower margins for manufacturers.

The generic drug market, which successfully provides access to affordable medications to the American public, faces several challenges:

- Low volume and margins for many generic drugs result in difficult economic conditions for new entrants.
- Anticompetitive actions may be used by certain countries to obtain market share.
- Contracting practices for distribution may lead to further consolidation through sole source contracting.

As a result, market and other factors contribute to risk in the drug supply chain, including:

- The complexity, vastness, and multinational nature of drug supply chains and the corresponding overdependence on foreign entities who may prioritize national interests above trade in an emergency.
- Reduced incentives for existing manufacturers to invest in upgrading equipment, improving supply chains, or expanding capacity.
- Lack of redundant capacity in manufacturing.
- Just-in-time inventory management practices that limit inventory and reduce the ability to respond to surges in demand.
- Geographic concentration of manufacturers that puts production at risk from natural disasters or climate change that can quickly affect an entire region.

Solutions to address the reliability of the pharmaceutical and API supply chain should address the following two priority objectives:

- **Improve supply chain transparency and incentivize resilience.** Policies should seek to provide increased transparency to distributors and purchasers of the sources of drug manufacturing and the quality of the facilities that make them. Greater transparency will incentivize distributors and purchasers to shift to more resilient sources of supply. Policies should also establish mechanisms to reward supply chain resilience and reductions in the severity of drug shortages.



- **Increasing the economic sustainability of U.S. and allied drug manufacturing and distribution.** U.S. and allied drug manufacturing, especially for generics and common drugs, is often undercut by foreign competition, particularly from India and China. While the United States does not need to make every drug itself, it does need increased domestic production capacity for key drugs. Policy tools to increase the economic sustainability of U.S. and allied drug manufacturing include providing predictability in production costs, pricing, and volume sold; increasing government and private sector flexibility in contracting and sourcing of finished drugs and raw materials; and studying whether the current market for finished drugs supports a diversification of supply instead of relying on one or two suppliers through preferred contractual arrangements.

To promote domestic growth, equity, and resilience throughout the pharmaceutical supply chain, a strategic approach that includes the following three elements is needed:

- Boosting local production and fostering international cooperation.
- Building emergency capacity.
- Increasing information available to the Food and Drug Administration (FDA) to improve its surveillance and shortage prevention and mitigation efforts.

### **Boosting Local Production and Fostering International Cooperation**

The first pillar of our strategy is to boost U.S. production while fostering greater international cooperation, which both enhances U.S. supply chain resilience and the resilience of the supply chains of U.S. partners and allies. Boosting U.S. production will require a blended mix of targeted investments and financial incentives, research and development (R&D) to create new manufacturing technologies, greater supply chain transparency, and better data collection.

This will include:

- Identifying financial incentives or investment (both public and private) that can help drive private sector willingness to develop domestic production capacity, including evaluating the merits of a successor financing program to the Defense Production Act (DPA) Loan Program.
- Establishing novel platform production technology.
- Creating transparency around quality management.
- Addressing regulatory questions presented by novel technologies and using a consortium to coordinate input from all necessary Government agencies.
- Empowering the FDA to collect critical new data necessary to have transparency into the supply chain to identify and mitigate risks.

### **Building Emergency Capacity**

Even as the U.S. bolsters domestic production, there will always be unforeseen events that will stress even the most resilient supply chain. In addition, onshoring and creating new supply chains with allies will be an investment that will take a number of years. The second pillar of supply chain resilience strategy is to build emergency capacity to ensure that we do not have shortfalls of critical drugs during times of crisis.

Specifically, under this strategy, we would explore the creation and expansion of a virtual strategic stockpile of API, other critical materials, and finished doses focusing on the most critical medications to have on hand for the American public and relying to the extent possible on domestic suppliers, especially small and small disadvantaged businesses. Managed by the Strategic National Stockpile, a virtual stockpile would involve contracts with API and drug suppliers to hold surplus together with support for surge manufacturing capacity rather than keeping APIs and drugs physically stockpiled in a central location.

## **Promoting International Cooperation and Partnering with Allies**

Domestic production is only one aspect of driving resilience in the pharmaceutical supply chain, since it is not feasible, desirable, or realistic to expect every drug needed for American patients to be produced on American soil. As such, and with the growing dominance of competitor nations, the United States must work with its like-minded regulatory partners to develop a secure and resilient supply chain that is not overly reliant on materials or manufacturing from countries that lack a shared interest in mutually beneficial supply chain arrangements. The third and final pillar of our strategy is to increase international cooperation and partner with allies to strengthen supply chain resilience. The U.S. Government should work through already established international regulatory collaboration and harmonization organizations, and, as needed, other bilateral and multilateral fora and engagements to strengthen drug and API supply chain cooperation.

## **INTRODUCTION**

Keeping the Nation's drug supply chain secure, robust, and resilient is essential for the national security and economic prosperity of the United States. All Americans deserve safe, effective, and high-quality medicines and assurance that their next dose of medicine will be available when they need it. Access to medicine is also a foundation for a quality education and a healthy workforce. Children who do not have access to needed medications may be unable to attend school, concentrate on learning, or socialize with other children, and their caregivers may be unable to enter the workforce. Employees who do not have access to needed medications may be unable to work. Both situations can lead to housing and food insecurity, cause substantial suffering for American families, and exacerbate inequities in the racial wealth gap. Finally, in the case of a natural disaster or a public health emergency, having an adequate surge supply of critical medications to meet these needs is essential to supporting relief and recovery efforts, and ultimately saving lives.

The mission of the U.S. Department of Health and Human Services (HHS) is to enhance the health and well-being of all Americans by providing for effective health and human services and by fostering sound, sustained advances in the sciences underlying medicine, public health, and social services. The agencies within HHS have different roles in supporting and protecting the pharmaceutical supply chain. HHS' comprehensive Supply Chain Risk Management (SCRM) Program detects and seeks to prevent disruptions in the pharmaceutical infrastructure by identifying risks and vulnerabilities associated with the dependency of critical supply chain elements controlled within foreign countries and by providing mitigation strategies.

The Food and Drug Administration (FDA) regulates which pharmaceuticals enter the U.S. market. A key component of FDA's mission is to protect public health by ensuring the safety, effectiveness, and security of human and veterinary drugs and biological products. FDA's Center for Drug Evaluation and Research (CDER) regulates human prescription drugs, including certain biological products, and over-the-counter drugs. CDER determines whether to approve drugs based on whether they meet applicable statutory and regulatory requirements for safety and effectiveness. CDER also monitors the safety of drugs on the market, including brand-name and generic drugs and brand-name and biosimilar biological products. FDA has access to commercially sensitive information on manufacturing of products that enter the country, allowing for: oversight of the quality of manufacturing facilities that produce these drugs, including biological products; continued product safety monitoring, including preventing the entry of fraudulent medications into the supply chain; monitoring of the supply chain for shortages; and working to mitigate and resolve the impact of such shortages. The Centers for Medicare & Medicaid Services (CMS), among other responsibilities, establishes payment policies for certain medications paid under the Medicare and Medicaid programs. In addition, CMS contracts with private companies to provide prescription drug benefits to beneficiaries under the Medicare Part D program. Medicare policies can be considered by private insurers and may be viewed generally as a benchmark. Other agencies within HHS and the United States Government are responsible for providing medical care to members of the military, veterans, Tribal communities, incarcerated individuals, and others, and therefore have a strong interest in a robust pharmaceutical supply chain that can deliver quality medications.

There are at least three critical pillars of a robust supply chain for pharmaceuticals that can optimally support the safety and security of the Nation's drug supply: (1) the ability to manufacture high-quality products for the

U.S. market; (2) diversification of the drug supply chain, such as relying on a geographically diverse set of manufacturers; and (3) redundancy of the supply chain, such as the existence of multiple manufacturers for each product and its precursors. A nimble structure that is flexible enough to change volumes and products in response to supply and demand is also important for a robust supply chain.

Although FDA is responsible for overseeing the quality of drugs and biological products marketed in the United States, it has limited ability to create incentives to address economic factors that may pose barriers to manufacturers' investments in improving or modernizing quality processes. Other federal agencies, such as CMS, set reimbursement and purchasing contracts that may exert some influence on diversification and redundancy in the supply chain.

This report primarily focuses on the supply chain for drugs, particularly small-molecule drugs and therapeutic biological products, including active pharmaceutical ingredients (APIs).<sup>1</sup> The report does not focus on the supply chains for vaccines, cell therapies, blood products, and their APIs because, due to the nature of these products, there are some distinct features in their supply chain that are beyond the scope of this report. These products are regulated by the FDA Center for Biologics Research and Evaluation (CBER).

Generic drugs make up 90 percent of the small molecules and therapeutic biologic drugs that are prescribed in the United States. These are often the drugs that are most critical across populations, safe and effective medicines at affordable prices has led to consolidations, caused firms to shift manufacturing to low-cost, largely foreign sites, and led to a reliance on foreign suppliers, which in turn has created vulnerabilities in the supply chain. The supply chain for these products is more difficult to monitor given their largely foreign production.

Although the focus of the report is on human drugs and therapeutic biological products, many of the same concerns apply to veterinary medicines used to treat service, companion, and food-producing animals.

This report provides a review of the structure of the drug supply chain and the threats to its security, resilience, and continuity, including the increased globalization that has occurred in recent decades. We highlight some of HHS' and other Federal agencies' activities to secure the supply chain, and suggest further actions needed to build a more resilient supply chain that is less vulnerable to disruptions and resulting shortages in order to ensure all Americans have access to safe, effective, high-quality medicines.

Strategies to create a robust and resilient pharmaceutical supply chain include diversification of supply, both domestic manufacturing and diversity in foreign resources, through leveraging partnerships with the private sector and international partners. Given the likely continued cost differentials between domestic and foreign products, innovation in manufacturing is a key component of the strategy to diversify manufacturing and increase domestic supply. This includes advanced manufacturing, a practice used in many industries that, when applied to drug manufacturing, leads to improved quality and more efficient plants that are economically more competitive with traditional facilities, more environmentally sustainable, and able to provide skilled job opportunities for Americans.

**Three pillars of a secure and robust drug supply chain are quality, diversification, and redundancy.**

---

<sup>1</sup> Active Pharmaceutical Ingredient (API): *Any substance that is intended for incorporation into a finished drug product and is intended to furnish pharmacological activity or other direct effect in the diagnosis, cure, mitigation, treatment, or prevention of disease, or to affect the structure or any function of the body. Active pharmaceutical ingredient does not include intermediates used in the synthesis of the substance.* 21 CFR 207.1

## MAPPING OF THE SUPPLY CHAIN

### From Raw Materials to Finished Dosage Forms

The drug manufacturing supply chain generally starts with suppliers of raw materials, such as solvents, reagents, and other chemicals that are combined by a series of reactions and then purified by a process designed to result in the desired APIs, or API intermediates,<sup>2</sup> of high purity and free of harmful impurities. A drug-product manufacturing facility then combines the APIs with various inactive ingredients (actual ingredients depend on final dosage form type, but can include water, lactose, and microcrystalline cellulose), then shapes and/or fills into the finished dosage forms (FDFs) (e.g., tablet or liquid). A single API, such as a synthetically-made API, may be produced using dozens of different chemicals, while a single drug product often has multiple ingredients, including many inactive ingredients, and may have a critical container or closure type to ensure continued quality (e.g., a glass vial). The timeframe for production using traditional batch manufacturing processes of an API varies widely, ranging from several days to several months, while a drug product may take several days to weeks to complete all steps and testing before a batch is safe to release for distribution. The pharmaceutical industry often uses a *just-in-time*<sup>3</sup> approach to keep costs low. As a result, manufacturers report that acute surges in demand or disruptions in the supply of materials and ingredients may quickly affect availability.

Figure 1: FDF Supply Chain Based on Traditional Manufacturing

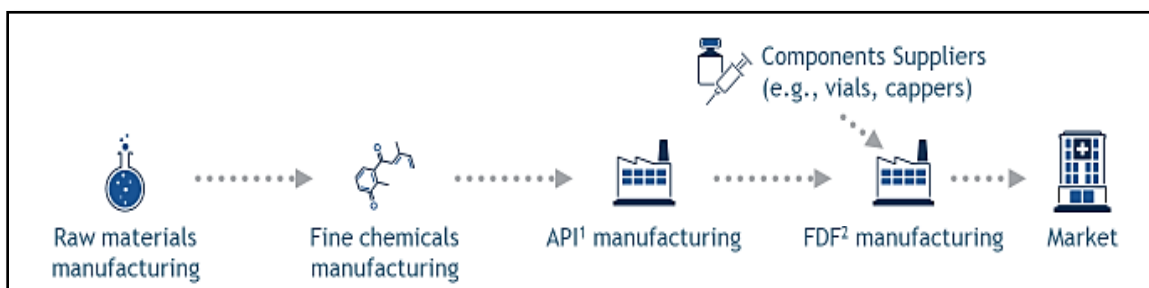

FDA evaluates API manufacturing sites, their selection and control over raw materials, and FDF manufacturing, including their selection and control over inactive ingredient and packaging material quality. However, FDA does not routinely inspect sites that manufacture raw materials for APIs and inactive ingredients.

### FDF Distribution Chain

Once an FDF is manufactured, the path to the patient can be similarly complex. Distribution from the manufacturer to patients can involve direct distribution to health care facilities or involve intermediaries such as wholesale distributors or third-party logistics providers. Primary and secondary wholesale distributors are sometimes referred to as "authorized distributors of record" <sup>4</sup> for manufacturers, as these distributors are those with whom a pharmaceutical manufacturer has established an ongoing relationship to distribute their product(s).<sup>5</sup> In the U.S. market, there are three major national wholesalers (AmerisourceBergen, Cardinal

<sup>2</sup> *API Intermediate: A material produced during steps of the processing of an API that undergoes further molecular change or purification before it becomes an API. API intermediates may or may not be isolated. API intermediates are only those produced after the point that a company has defined as the point at which the production of the API begins. Q7 Good Manufacturing Practice Guidance for Active Pharmaceutical Ingredients Guidance for Industry. Available at <https://www.fda.gov/regulatory-information/search-fda-guidance-documents/q7-good-manufacturing-practice-guidance-active-pharmaceutical-ingredients-guidance-industry>. Accessed on 5/25/2021.*

<sup>3</sup> The just-in-time inventory system is a management strategy that aligns raw-material orders from suppliers directly with production schedules. Companies employ this inventory strategy to increase efficiency and decrease waste by receiving goods only as they need them, which reduces inventory costs.

<sup>4</sup> 21 U.S.C. 353(d)(4); 21 C.F.R. § 203.3.

<sup>5</sup> Hemphill, T., U.S. Pharmaceutical Gray Markets: Why Do They Persist—and What to Do about Them? *Business and Society Review* 121:4 529–547, 2016.

Health, and McKesson), a few regional wholesalers, and thousands of secondary wholesalers.<sup>6</sup> Contracting practices, such as sole source contracts, can limit redundancy in supply. In addition, the market power of group purchasing organizations (GPOs) allows them to assert more price pressure on generics.

Figure 2: Schematic of the FDF distribution chain showing both distribution of product and reimbursement

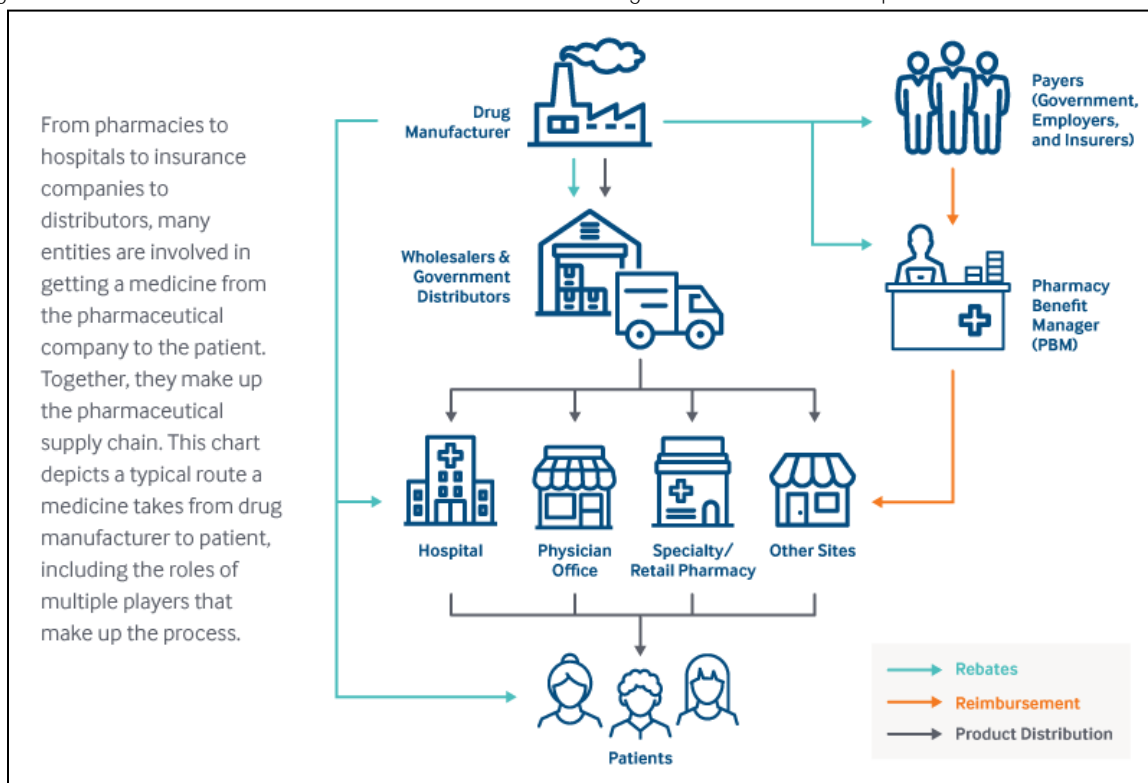

Data: Adapted from Janssen Global Services, LLC, *2018 Janssen Global Transparency Report* (Janssen, Mar. 2019), 21. Source: Lauren Vela, *Reducing Wasteful Spending in Employers' Pharmacy Benefit Plans* (Commonwealth Fund, Aug. 2019). <https://doi.org/10.26099/8tfg-zq89>. Reproduced with permission.

## Where Are Our Drugs and Their Components Produced?

Over the past 30 years, pharmaceutical manufacturing has become an increasingly global enterprise. Beginning in the 1970s, industry moved away from the mainland United States, first to Puerto Rico in response to tax incentives, and then to Europe and developing nations such as China and India. As the U.S. drug market shifted toward lower-priced generic drugs, which make up 90 percent of all prescription medications filled, 20 percent of all prescription drug spending,<sup>7</sup> and is estimated to have saved the U.S. health care system \$2.2 trillion dollars in the past decade,<sup>8</sup> manufacturers came under increasing cost pressure. This led manufacturers to relocate more of their facilities overseas, particularly to developing parts of the world. Developing nations can provide significant cost savings to pharmaceutical companies because of their lower labor, energy, and transportation costs. In addition, differences in environmental standards may lead to less expensive overseas manufacturing of raw materials, fine chemicals, and API. Manufacturers

<sup>6</sup> *Countering the problem of falsified and substandard drugs*. Washington, DC: The National Academies Press, 2013.

<sup>7</sup> 2020 Generic Drug & Biosimilars Access & Savings in the U.S. Report. Available at: <https://accessiblemeds.org/sites/default/files/2020-09/AAM-2020-Generics-Biosimilars-Access-Savings-Report-US-Web.pdf>. Accessed on 4/8/2021.

<sup>8</sup> Office of Generic Drugs 2020 Annual Report. Available at <https://www.fda.gov/drugs/generic-drugs/office-generic-drugs-2020-annual-report>. Accessed 04/7/2021

of older generic drugs face especially intense price competition, uncertain revenue streams, and, for certain sterile products, high investment requirements, all of which limit potential returns.<sup>9</sup>

Therefore, it is not surprising that in March 2021, 52 percent of all FDA-registered FDF manufacturing facilities were outside the United States, and 73 percent of all FDA-registered API manufacturing facilities were outside the United States. Of all FDA-registered generic drug manufacturing facilities making FDFs, 63 percent were outside the United States, and 87 percent of FDA-registered manufacturing facilities making APIs used in generic products were located outside the United States. (See Figures 4-7.)

These overall figures are limited in demonstrating risk because of the lack of volume data. In the generic market, 87 percent of API facilities are outside the United States, but FDA does not have data on the volume of API that is produced outside the United States, which could be lower or higher. Similarly, as detailed below, China and India could account for 42 percent of facilities, but the volume could be higher depending on whether a company preferentially relies on a particular facility.

Figure 3: Illustrative Supply Chain Map

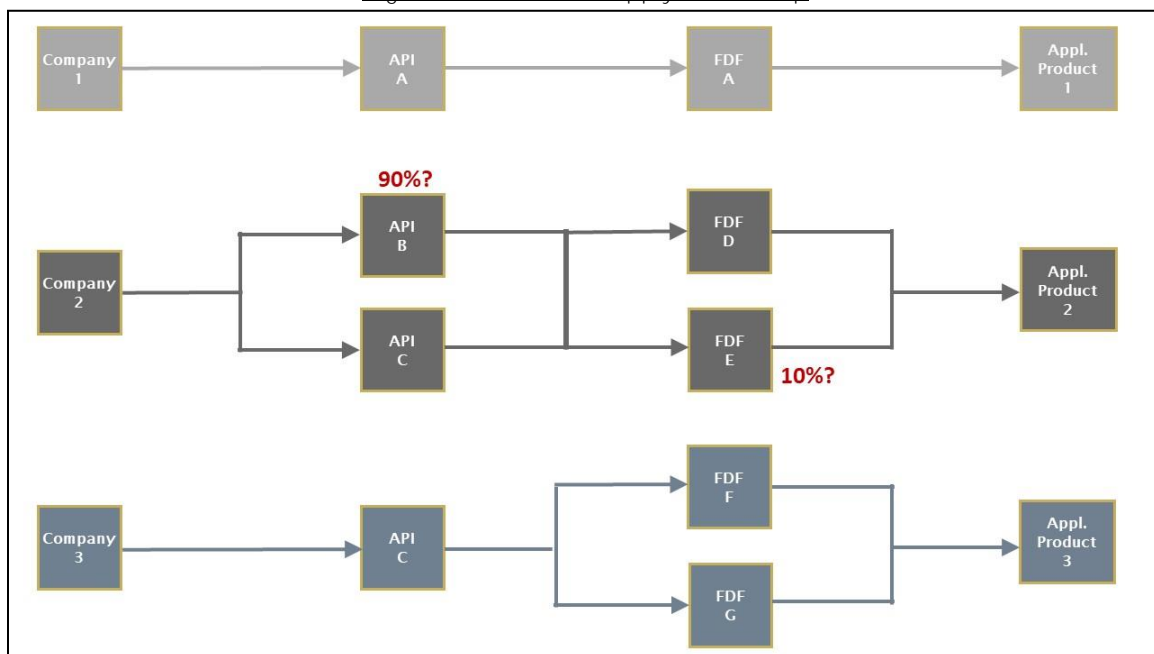

This figure demonstrates the complexity of the manufacturing supply chain. Using facility information alone does not account for the volume that may be manufactured at a given facility. For example, one doesn't know whether API B is producing 90 percent and FDF E is producing 10 percent.

It is important to note that FDA only has data for API and FDF facilities and does not include data from facilities that produce fine chemicals. This may not capture the true reliance on foreign countries such as China, which may produce large quantities of fine chemicals for registered facilities, but the quantities are not reported through registration requirements.<sup>10</sup>

The economic savings from moving production abroad can be substantial and may be necessary to remain competitive, particularly in the generic market where the only market difference between products is price since generics are routinely substituted for each other. A 2009 paper by the World Bank, "Exploratory Study on Active Pharmaceutical Ingredient Manufacturing for Essential Medicines," stated that if a typical Western

<sup>9</sup> U.S. Food and Drug Administration, *Drug Shortages: Root Causes and Potential Solutions* (p. 21), 2019, updated 2020. Available at: <https://www.fda.gov/media/131130/download>. Accessed on 4/5/21.

<sup>10</sup> *Drug Shortages: Root Causes and Potential Solutions*, U.S. Food and Drug Administration, 2019, Updated 2020. Available at: <https://www.fda.gov/media/131130/download>. Accessed on 4/2/2021.

API company has an average wage index of 100, this index is as low as 8 for a Chinese company and 10 for an Indian company.<sup>11</sup> FDA's 2011 report, "Pathway to Global Product Safety and Quality," noted that both China and India have a labor cost advantage and that API manufacturing in India can reduce costs for U.S. and European companies by an estimated 30–40 percent.<sup>12</sup>

Figure 4: Percentage of FDF Manufacturing Facilities for All Drugs by Country or Region, March 2021

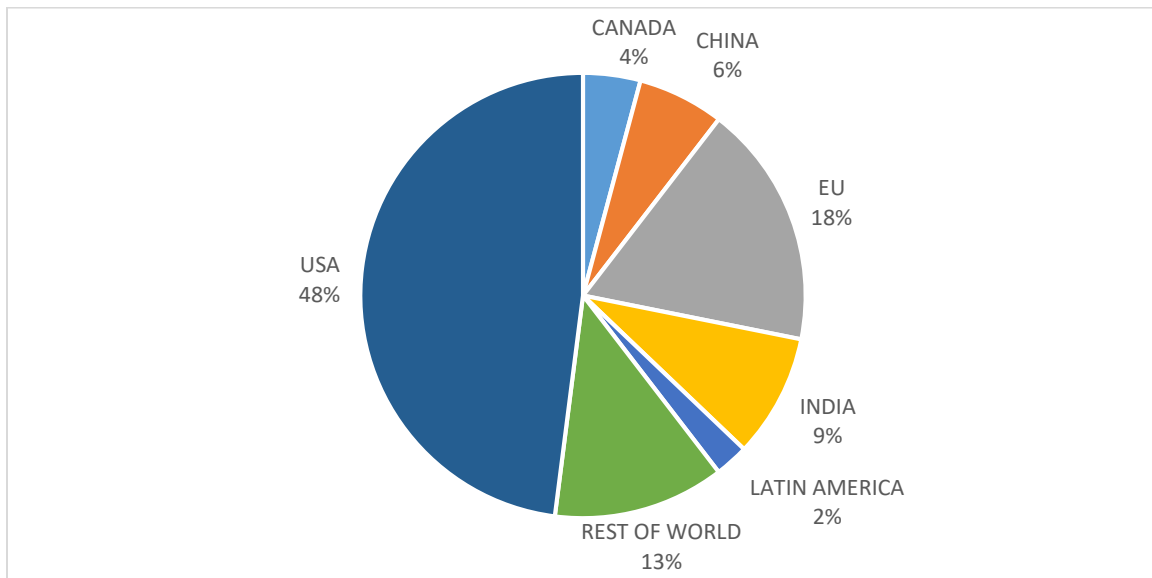

For all FDA-regulated drugs, 52 percent of FDF manufacturing facilities are located outside of the United States.

<sup>11</sup> Bumpas, J and E Betsch, *Exploratory study on active pharmaceutical ingredient manufacturing for essential medicines*. Health, Nutrition and Population (HNP) discussion paper. Washington, DC: World Bank. Available at: <https://documents.worldbank.org/en/publication/documents-reports/documentdetail/848191468149087035/exploratory-study-on-active-pharmaceutical-ingredient-manufacturing-for-essential-medicines>. Accessed on 4/2/2021.

<sup>12</sup> U.S. Food and Drug Administration, [Pathway to Global Product Safety and Quality](#), A Special Report, p.20. Accessed on 4/2/2021.

Figure 5: Percentage of API Manufacturing Facilities for All Drugs by Country or Region, March 2021

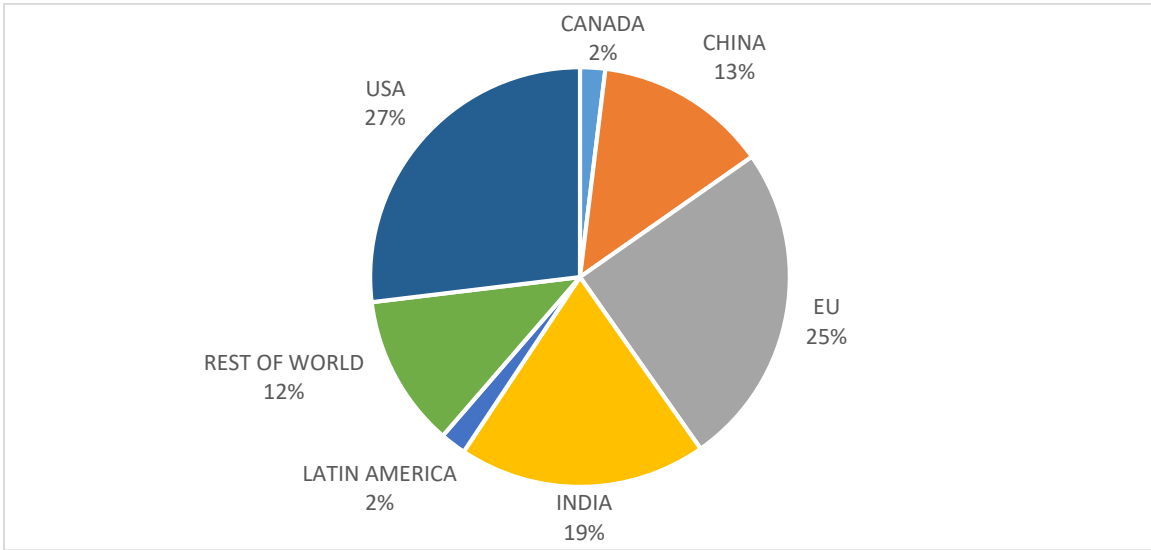

For all FDA-regulated drugs, 73 percent of manufacturing facilities producing APIs are located outside the United States.

Figure 6: Percentage of FDF Manufacturing Facilities for Generic Drugs (Approved under Abbreviated New Drug Applications (ANDAs)) by Country or Region, March 2021

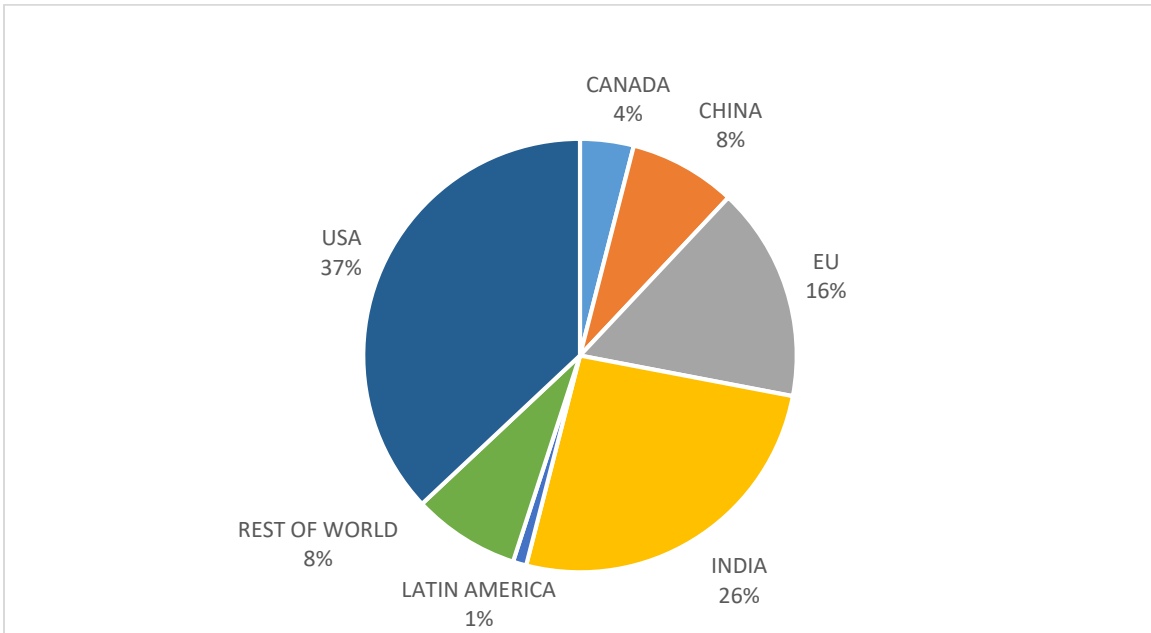

For generic drugs (approved under ANDAs), 63 percent of FDF manufacturing facilities are located outside the United States.



Figure 7: Percentage of API Manufacturing Facilities for Generic Drugs (Approved Under ANDAs) by Country or Region, March 2021

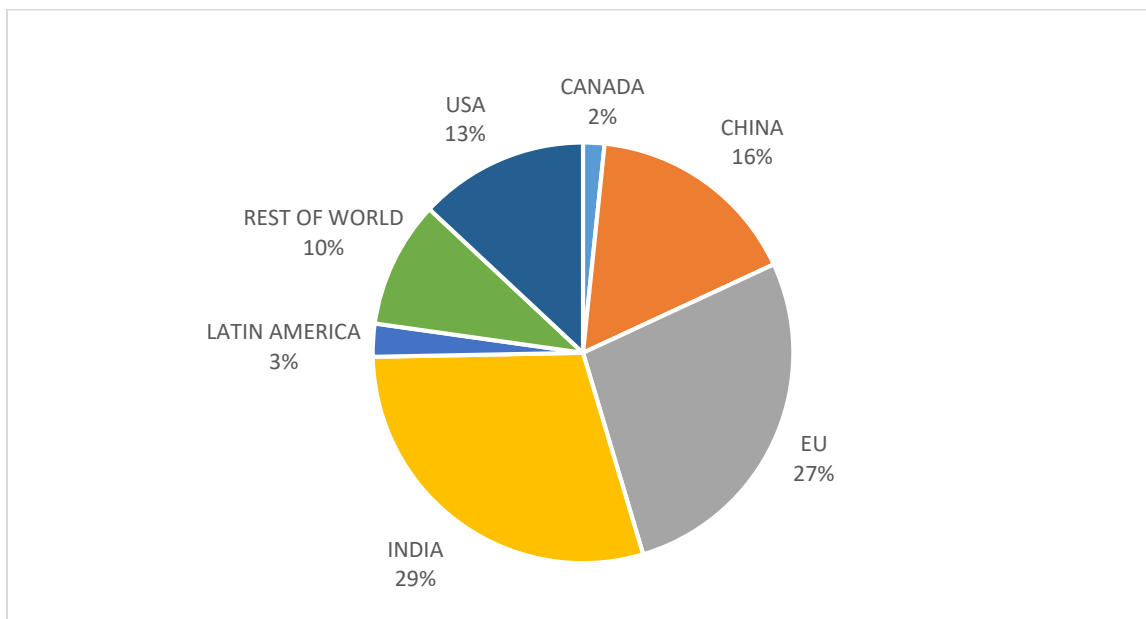

For generic drugs (approved under ANDAs), 87 percent of manufacturing facilities producing APIs are located outside the United States.

## RISK ASSESSMENT

As stated earlier, the three pillars on which supply chain resilience rests are quality, diversification, and redundancy. Given generally higher profit margins, there are economic incentives for brand-name drug manufacturers to continue ensuring a robust supply of brand-name drugs. According to comments from PhRMA in response to Docket No. BIS-202-0034,<sup>13</sup> manufacturers of brand-name or innovative medicines implement risk management plans as standard practice that may include alternative manufacturing sites, inventory reserves, and/or a range of global external suppliers and logistics planning to ensure continuity of shipping lines. Supply chains for brand-name drugs are likely at less risk. However, brand-name drug supply chains may still be complex, involving various suppliers and contractors and employing just-in-time manufacturing, and therefore are still vulnerable to disruption.

### Drug Shortages are the Culmination of Supply Chain Risks

Drug shortages, including those that arise during natural disasters or public health emergencies, have been a persistent problem despite public and private sector efforts to prevent and mitigate them. The Federal Food, Drug, and Cosmetic Act (FD & C Act) defines drug shortage to mean “a period of time when the demand or projected demand for the drug within the United States exceeds the supply of the drug.”<sup>14</sup> Although the overall number of new shortages per year is relatively low compared to the number of medications on the market (Figure 8), the consequences can be significant.

<sup>13</sup> Notice of Request for Public Comments on Condition of the Public Health Industrial Base and Recommend Policies and Actions to Strengthen the Public Health Industrial Base to Ensure Essential Medicines, Medical Countermeasures, and Critical Inputs Are Made in the United States, Docket No. BIS-2020-0034

<sup>14</sup> CDER Manual of Policies and Procedures on Drug Shortage Management 4190.1 Rev 2.

<http://www.fda.gov/downloads/aboutfda/centersoffices/officeofmedicalproductsandtobacco/cder/manualofpoliciesprocedures/ucm079936.pdf>. Accessed on 5/9/2021

Figure 8: Total New Drug Shortages per Year – CDER and CBER<sup>15</sup>

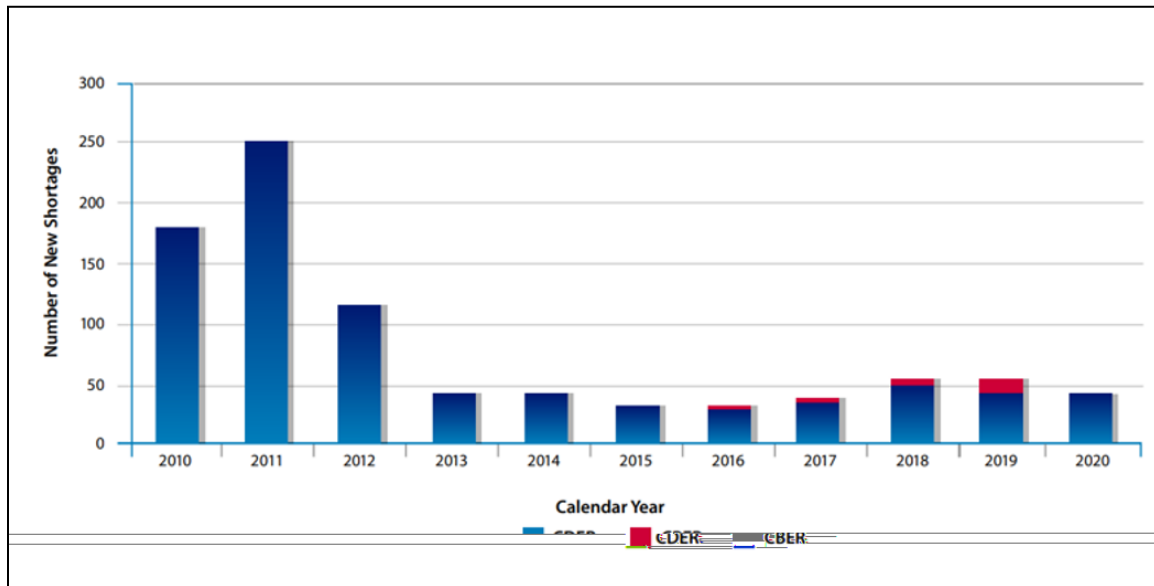

Information from health care providers, patients, and research studies suggests that the clinical and financial effects of shortages are substantial. Shortages can worsen patients' health outcomes by causing delays in treatment or undesirable changes in treatment regimens. A 2012 Associated Press article reported 15 deaths attributed to drug shortages over 15 months.<sup>16</sup> In 2007, it was estimated that hospitals spent \$286 million managing shortages.<sup>17</sup> Comprehensive data about the effects of shortages are lacking, and FDA believes that some recent attempts to quantify the impacts have underestimated them.

Although the number of new shortages has been declining since reaching a peak in 2011, FDA analysis shows that the number of ongoing drug shortages has been increasing since 2017, and that drug shortages have been lasting longer, in some cases more than 8 years. FDA analyzed 163 drugs that went into shortage in the 5-year period between 2013 and 2017. Of the 163 drugs in the sample, 63 percent (103) were drugs administered by injection ("sterile injectables") and 67 percent (109) were drugs that have a generic version on the market. They were also older drugs, with a median time since first approval of almost 35 years. After many years off patent, the sterile injectables were typically sold at relatively low prices. In the year prior to going into shortage, the median per unit price was \$8.73 for all the shortage drugs, \$11.05 for sterile injectables, and \$2.27 for orally administered drugs.<sup>18</sup>

Medications used in acute care, a setting in which delays in treatment may be less tolerated, are often subject to shortage. It has also been noted that the risk of medical errors with substitutions due to a shortage may be higher in certain acute care settings such as emergency rooms when there is a substitution of a drug or even the same drug but in a different concentration.<sup>19</sup> One analysis looked at 1,929 national drug shortages from 2001 through 2014.<sup>20</sup> The most common classes of drugs on shortage were drugs to reduce pain and fever

<sup>15</sup> CBER is the Center within FDA that regulates biological products for human use under applicable federal laws, including the Public Health Service Act and the FD&C Act.

<sup>16</sup> [https://www.inquirer.com/philly/business/20110924\\_Drug\\_shortage\\_stirs\\_fears.html](https://www.inquirer.com/philly/business/20110924_Drug_shortage_stirs_fears.html). Accessed on 5/2/2021.

<sup>17</sup> Mazer-Amirshahi, M et al., 2014. Critical drug shortages: implications for emergency medicine, *Academic Emergency Medicine*, 2014;21:704–711. Available at: <https://pubmed.ncbi.nlm.nih.gov/25039558/>. Accessed on 4/2/2021.

<sup>18</sup> Drug Shortages: Root Causes and Potential Solutions, U.S. Food and Drug Administration, 2019, Updated 2020. Available at: <https://www.fda.gov/media/131130/download>. Accessed on 4/2/2021.

<sup>19</sup> Mazer-Amirshahi, M et al., 2014. Critical drug shortages: implications for emergency medicine, *Academic Emergency Medicine*, 2014;21:704–711. Available at: <https://pubmed.ncbi.nlm.nih.gov/25039558/>. Accessed on 4/2/2021.

<sup>20</sup> This source did not use FDA's definition of drug shortage but instead looked at the ASHP Foundation drug shortage database, focusing on critical shortages <https://www.ashp.org/shortages?loginreturnUrl=SSOCheckOnly>.

(17 percent), anti-infectives (14 percent), cardiovascular drugs (8 percent), and electrolyte, caloric, and water balance products (7 percent). This study found that 52 percent of these shortages (total number of shortages: 1,006) involved acute care drugs used in emergency departments (i.e., for management or diagnosis of acute conditions.) This same analysis also found that 70 percent of the drug products affected by shortages in that same time period were delivered by injection. The classes of emergency department drugs often subject to shortages included anticonvulsants, analgesics, anesthetics and sedatives, and cardiovascular drugs.<sup>21</sup>

Shortages can create challenges for federal agencies<sup>22</sup> involved in the procurement of pharmaceuticals for patient care. Drug shortages can lead to unexpected, significant increases in pricing that can be challenging for federal health agencies because they are subject to mandated price or vendor restrictions. This is particularly problematic when their normal contracts can no longer meet demand. There is not a mechanism to ensure appropriate allocation of essential drugs during periods of acute shortage. For example, one federal agency shared that during the surge of COVID-19 cases in New York City in spring 2020, purchasing critical medications from one of the primary wholesalers was done by health care institutions competing against each other for such medication on a daily basis.

### **Location of Facilities Does Not Provide Sufficient Data to Draw Conclusions on Risks to Supply Chain**

FDA published a List of Essential Medicines, Medical Countermeasures, and Critical Inputs in October 2020 in response to the August 6, 2020, Executive Order (E.O.) 13944 on "Ensuring Essential Medicines, Medical Countermeasures, and Critical Inputs Are Made in the United States." **The Essential Medicines List** focuses on those medications needed most by patients in U.S. acute care medical facilities specializing in short-term treatment for severe injuries or illnesses, or those with urgent medical conditions. The Essential Medicines List also includes FDA-regulated products (biologics, drugs, and devices) that (1) meet the definition of a "medical countermeasure" provided in the executive order and (2) the FDA anticipates will be needed to respond to future pandemics, epidemics, and chemical, biological, and radiological/nuclear threats. When identifying essential medicines and medical countermeasures, FDA focused on including therapeutics that are medically necessary to have available in adequate supply and can be used for the widest populations to have the greatest potential impact on public health. Many of these medications, including generic sterile injectables, have been essential for the most critically ill patients during the COVID-19 pandemic.

The supply chains for many of these essential medications are complex, and the APIs and FDFs are often highly concentrated in certain countries. An analysis by HHS of 120 medications, of which 118 are from FDA's 2020 Essential Medicines List (most small molecules and biological products, including 2 vaccines), found that domestic API facilities are available for only 60 drugs. In addition, for 50 of the drugs, 70 percent of their API facilities are located in Asia.<sup>23</sup>

---

<sup>21</sup> Chen, SI et al., 2016. Despite Federal Legislation, Shortages of Drugs Used in Acute Care Settings Remain Persistent and Prolonged, *Health Affairs*, 35(5):798–804. Available at: <https://www.healthaffairs.org/doi/10.1377/hlthaff.2015.1157>. Accessed on 4/2/2021.

<sup>22</sup> Conversation with FDA staff during preparation of this report.

<sup>23</sup> Newport Sourcing API Manufacturing Locations, Clarivate Analytics 2020.

Figure 9: Percentage of API Manufacturing Facilities by Geography<sup>24</sup>

Of 120 critical medicines, roughly only half have domestic API manufacturing sites (relative volume domestic vs. foreign being researched)

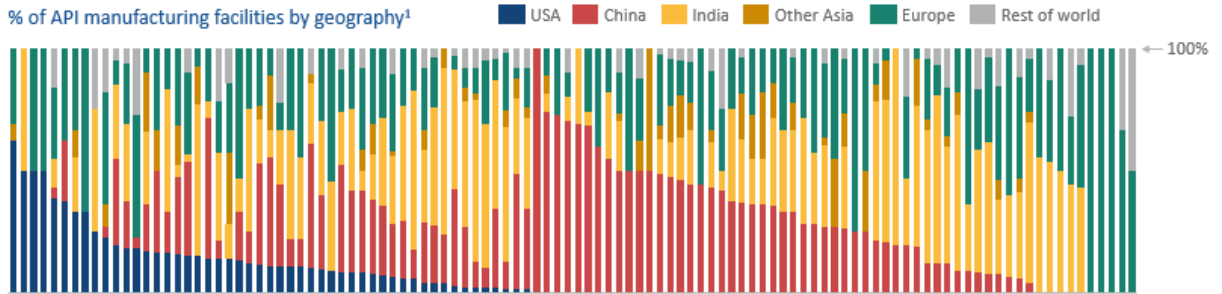

For these critical Medicines . . .

- ~ 50% do not have any domestic API facilities
- ~ 4% do not have API facilities in US, Canada or Europe
- ~ 8% can only be sourced from one continent

Source: Newport Sourcing API Manufacturing Locations, Clarivate Analytics 2021

Preliminary analysis: Of the 118 essential medicines, roughly only half have domestic API manufacturing sites.

<sup>24</sup> Newport Sourcing API Manufacturing Locations, Clarivate Analytics 2020.

Figure 10: Analysis of Select Essential Medicines by Geography and Shortage Status

## Selected Essential Medications: Mfg site location and FDA shortage reporting

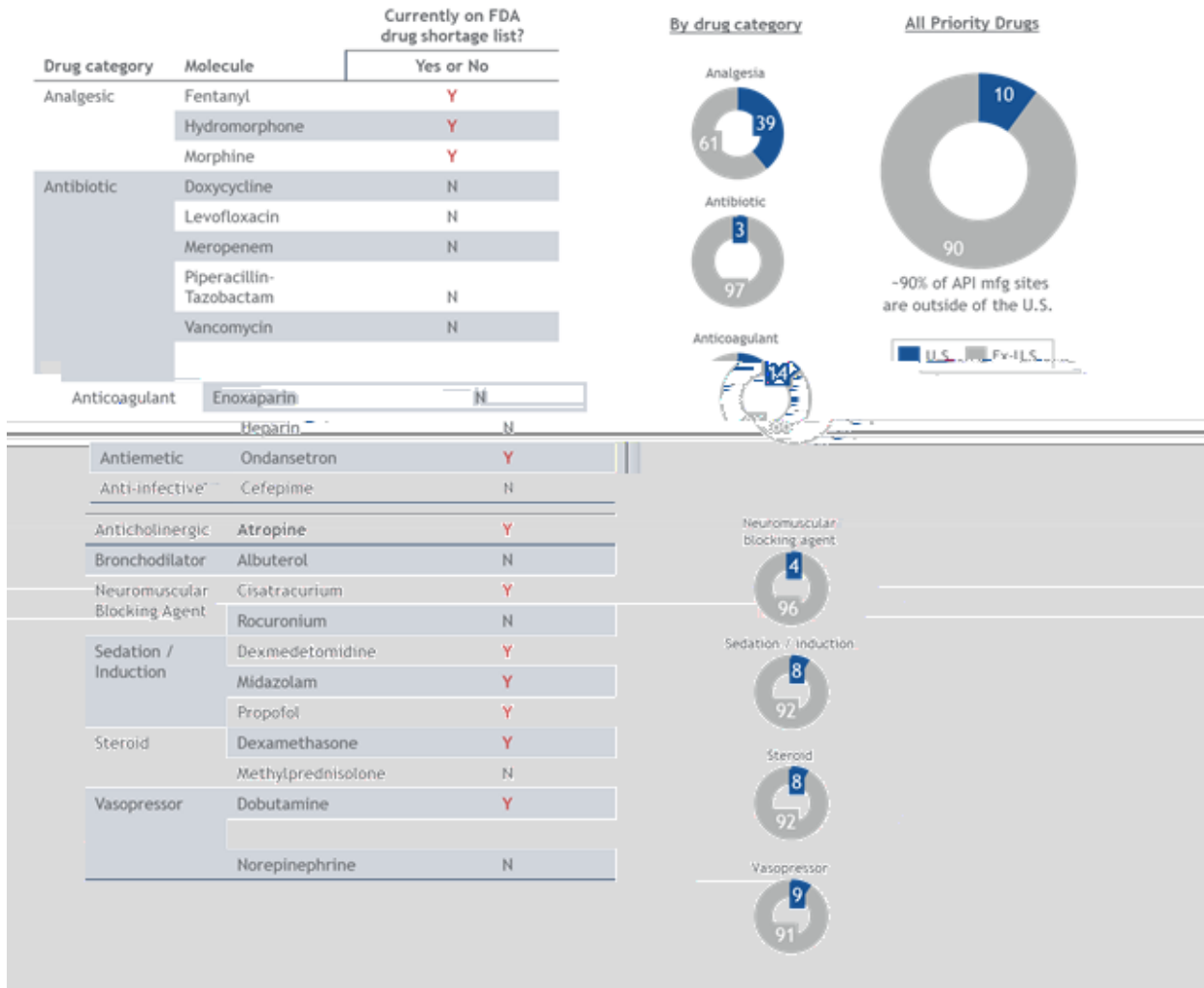

Further analysis of selected Essential Medicines with less than 40 percent of API facilities in the United States.

Per the figures above, a number of medications on the FDA Essential Medicine list have been in shortage. At the time FDA's Essential Medicines List was published, 25 percent of CDER-regulated drug products (excluding the medical countermeasures, vaccines, blood products, antivenoms and antitoxins) that were on the List were in shortage. This analysis was repeated on April 30, 2021, about 6 months after the publication of the Essential Medicines List. At that time, 32 unique CDER-regulated drugs on the Essential Medicines List were in shortage, including many of the drugs that were in shortage in October 2020. Of these 32 drugs, 94 percent were sterile injectables. An additional 13 non-List drugs (92 percent sterile injectables) that were from the same classes of drugs on the Essential Medicines List were also in shortage. Therefore, at least 45 drugs that are used in acute care settings were in shortage. Of these 45 drugs, the most frequent classes were the following: cardiovascular (18 percent), fluids, electrolytes, and nutrition (18 percent), anti-infectives (16 percent), sedatives (11 percent), pain control (including opioids) (13 percent), gastrointestinal (9 percent), and neuromuscular blocking agents (4 percent).

While the graphs above show drugs where API facilities are highly concentrated outside the United States and include drugs that were in shortage as of March 2021, Figures 11 and 12 display just the location of the API and FDF facilities registered with FDA for the 32 products from the Essential Medicines List that were in

shortage as of March 2021. Although manufacturers list more than one API or manufacturing facility for individual drugs, this type of graphical representation of the location of facilities may be misleading in that it implies there is a diversity in supply when in practice a single facility may be the primary producer of API or FDF, as displayed in Figure 3. Without knowing the volume of production of each facility in real-time, it is difficult to draw conclusions about what the supply chain actually looks like. Nevertheless, the location of facilities alone may not be a sufficient predictor of risk for shortage (i.e., this graph does not demonstrate that drugs that go into shortage only have API facilities or FDF facilities located in one or two locations.) Of note, when 12 medications from the Essential Medicines List that did not go into shortage were added into the cohort, the patterns of facility locations did not change overall.

Figure 11: Percentage of API Facilities for Various Therapeutic Classes by Geographic Location

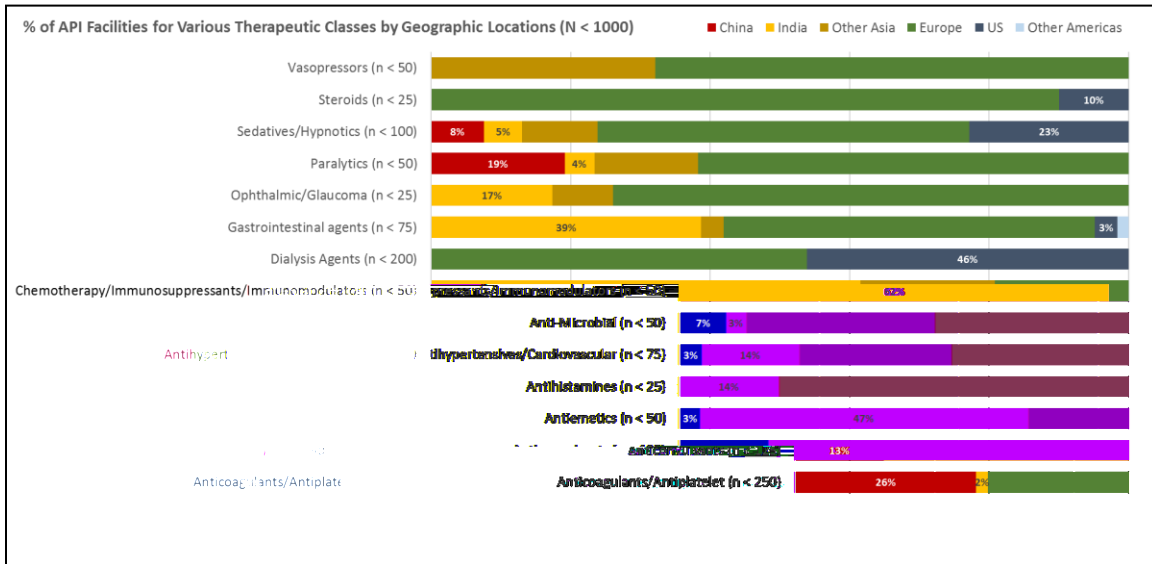

Data: Essential Medicines in Shortage, March 2021

Figure 12: Percentage of FDF Facilities for Various Therapeutic Classes by Geographic Location

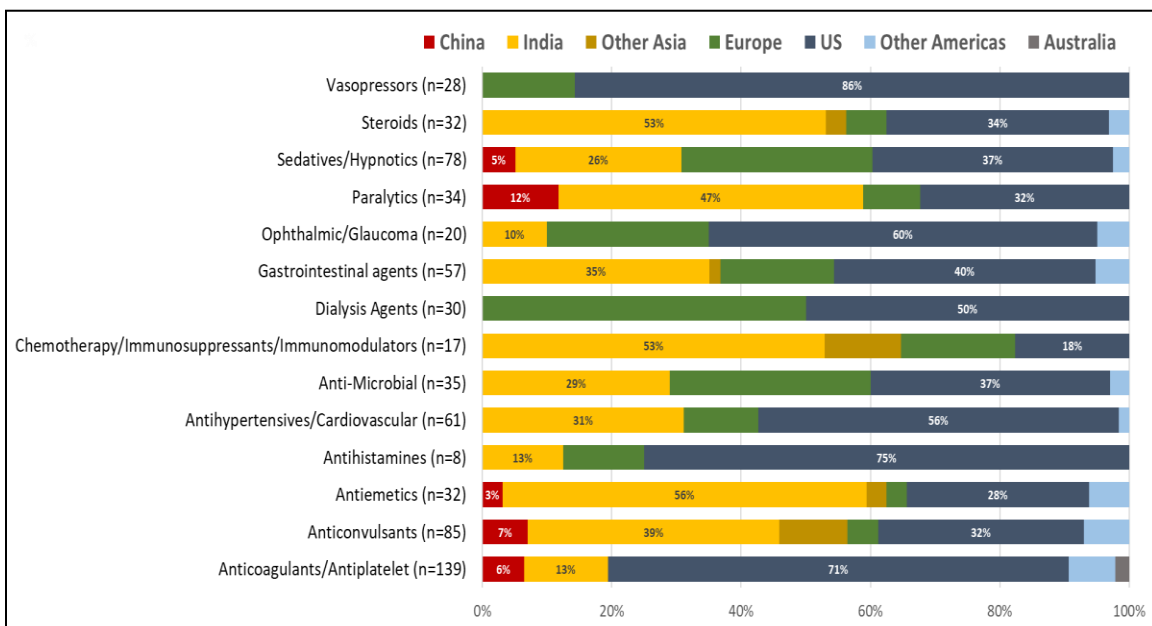

Data: Essential Medicines in Shortage, March 2021

## **Sterile Injectables – The Intersection of Price, Quality Investment, and Shortages**

Although geographic location alone may not be a risk factor for shortage, being a sterile injectable does seem to be a risk. Most of the medications in shortage from the Essential Medicines List are also sterile injectables. An example of what can happen in the sterile injectable market is demonstrated by a previous shortage of propofol, a critical drug used for sedation in intensive care units for patients with COVID-19 and which has been in shortage during COVID-19, leading FDA to use its emergency use authorization authority to authorize imports of propofol not approved for marketing in the United States. In 2009, FDA investigated a facility in follow up to a recall by a manufacturer and confirmed the manufacturer's finding that the product had high levels of endotoxin, which can cause fever and shock. Previously, another manufacturer had recalled product for particulate contamination. By early 2010, both companies halted production, leaving a single manufacturer to meet demand, and a drug shortage occurred.<sup>25</sup> Therefore, even with three manufacturers, an unexpected disruption in manufacturing can quickly lead to a shortage.

In 2011, when drug shortages peaked, 56 percent of the shortages for sterile injectables were due to quality-related failures of manufacturing the FDF.<sup>26</sup> A single quality problem at a single facility can contribute to a national shortage. In the case of norepinephrine, two manufacturers temporarily halted or experienced delays in production in 2010 and 2011.<sup>27</sup> Shortage followed and led to patients with septic shock being treated with alternative drugs. When patients with septic shock were admitted to hospitals experiencing the shortage, they were more likely to die than at hospitals not experiencing the shortage.<sup>28</sup> In addition, product discontinuations accounted for another 9 percent of sterile injectable shortages. Some of the decisions to discontinue manufacturing may be related to low reimbursement for older sterile injectables, as noted in FDA's analyses of sterile injectables that went into shortage. When a company reaches manufacturing capacity, it may look at less profitable lines to discontinue to increase production of more profitable products.

Sterile injectables are susceptible to shortage due to manufacturing disruptions because the aseptic manufacturing of sterile drugs is not forgiving, and if not properly attended to, can lead to contamination. In addition to bacteria, mold, and endotoxin contamination, FDA has seen manufacturing disruptions due to shards of glass and metal in vials.<sup>29</sup> The problems have different etiologies but can be linked to insufficient maintenance of production facilities and equipment, as well as suboptimal quality control testing and oversight. FDA postulates that at the core of these failures is the inability of the market to reward quality; instead, generics compete primarily on price. Of note, this is not necessarily an issue of foreign manufacturing because much of the sterile injectable manufacturing is located in the United States due to the high cost of transporting liquids that often require climate control.

Another factor that can turn a single production line disruption into drug shortage is concentration of market share. An analysis of 2008 national sales data from Intercontinental Medical Statistics Health indicated that at that time, seven firms produced nearly all sterile injectables as measured in standard units. Using these data to drill down into classes of drug, one can look at market concentration.

---

<sup>25</sup> Woodcock, Wosinska, *Economic and Technological Drivers of Generic Sterile Injectable Drug Shortages*, *Nature Publishing*, 93(2): Feb 2013.

<sup>26</sup> *Ibid.*

<sup>27</sup> Donohue, JM et al., *National Shortages of Generic Sterile Injectable Drugs, Norepinephrine as a Case Study of Potential Harm*. *JAMA* 2017;317(14):1415-1417. doi:10.1001/jama.2017.2826. Accessed on 4/2/2021.

<sup>28</sup> *Drug Shortages: Root Causes and Potential Solutions*, U.S. Food and Drug Administration, 2019, Updated 2020. Available at: <https://www.fda.gov/media/131130/download>. Accessed on 4/2/2021.

<sup>29</sup> Woodcock, Wosinska, *Economic and Technological Drivers of Generic Sterile Injectable Drug Shortages*, *Nature Publishing*, 93(2): Feb 2013.

Figure 13: Graphical Representation of Concentration in Sterile Injectable Market in 2008 Based on Intercontinental Medical Statistics Health National Sales Perspective<sup>30</sup>

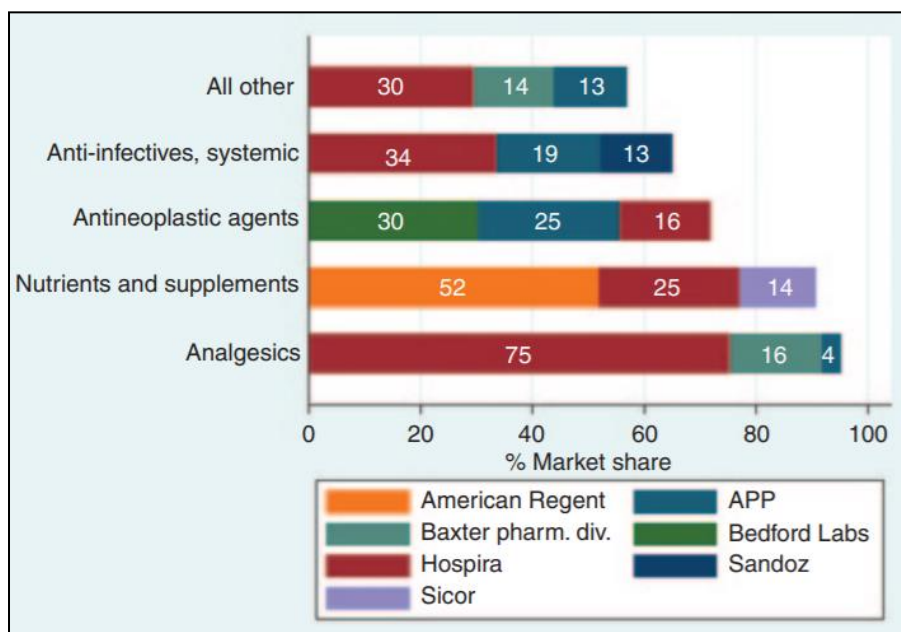

Concentration of market share is due to the need for highly specialized facilities with well-defined manufacturing process and controls to assure that they are sterile and free from visible particulate matter. In addition, there may be specific production lines within those facilities to prevent potential cross-contamination. In a review of over 900 sterile injectable approved ANDAs (for generic drugs) between 2000 and 2011, only 1 percent referred to more than one facility for production of the finished product. In contrast, 20 percent of branded (non-generic) sterile injectable applications were approved with back-up facilities. Approximately 6 percent of the ANDAs in this cohort subsequently submitted additional production sites.<sup>31</sup>

In sum, a number of factors in the sterile injectable market can lead to quality-related production disruptions and shortages of these critical drugs.

<sup>30</sup> Ibid.

<sup>31</sup> Ibid.



Figure 14: Economic Drivers of Manufacturing Quality Problems

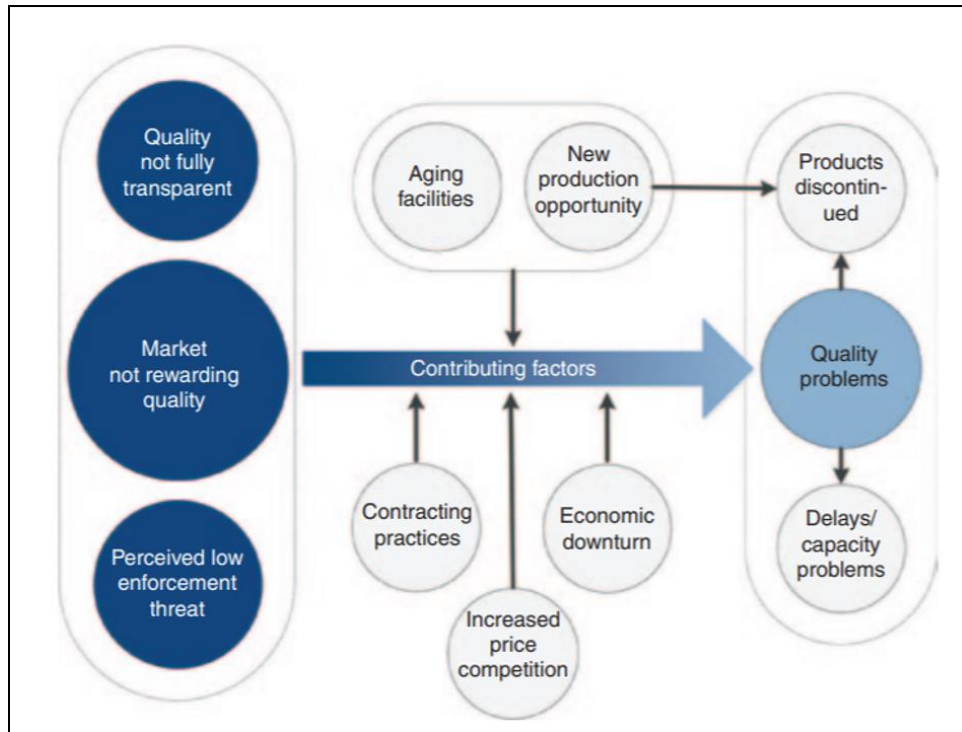

Source: Reproduced from Woodcock, Wosinska, Economic and Technological Drivers of Generic Sterile Injectable Drug Shortages, Nature Publishing,93(2): Feb 2013.

In 2018, in response to a request from Congress, FDA convened an inter-agency Drug Shortages Task Force to oversee the analysis of drug shortage data and develop recommendations based on insights gleaned from public and private stakeholders as well as FDA data analysis and published research. The resulting report, Drug Shortages: Root Causes and Potential Solutions, published in 2019 and updated in 2020, identified three root causes for drug shortages:

- Manufacturers lack incentives to produce drugs that are less profitable;
- The market does not recognize and reward manufacturers for “mature quality management systems” that focus on continuous improvement and early detection of supply chain issues; and
- Logistical and regulatory challenges make it difficult for the market to recover from disruption.

Drug shortages also persist because they do not appear to resolve according to the “textbook” pattern of market response. In this more typical pattern, prices rise after a supply disruption and provide an incentive for existing and new suppliers to increase production until there is enough supply of a product to meet demand. In this respect, the market for prescription drugs and especially generic drugs differs from other markets due to the high investment costs to enter the market (including the need for regulatory approvals), and price pressures that may create uncertainty about getting an adequate return on investment. For example, according to FDA’s analysis of 163 drugs that went into shortage:<sup>32</sup>

- Only 18 percent had a sustained price increase (i.e., an increase of 50 percent or more that began during the shortage and lasted for 6 months).<sup>33</sup>

<sup>32</sup> For most of the drugs, FDA can evaluate the market reaction. However, for a small number of drugs we were unable to evaluate the market reaction due to limitations of the available data.

<sup>33</sup> These results are qualitatively similar using alternative price increase thresholds ranging between 25 and 50 percent increases, and an alternative time horizon of 3 months. For example, using a 3-month time horizon still yields 18 percent of drugs. Likewise, a 25 percent price increase over 6 months yields 25 percent of drugs.

- Only 42 percent had significant production increases (either new suppliers entering the market or existing suppliers increasing production during the shortage to restore at least 50 percent of the unavailable quantity).
- Only 30 percent had the quantity of the drug sold restored to at least 100 percent of its amount prior to the shortage (after 12 months of being in shortage, or at the end of the shortage if it had already resolved within 12 months).

## What Happened to Domestic Manufacturing?

### *Cost Pressures Drive Manufacturing Overseas*

Cost pressures are likely one of the primary drivers of moving manufacturing overseas and likely disproportionately affect the generic drug market.

In contrast to the brand market, economic pressures on the generic market lead to greater supply chain vulnerability. The price of generics goes down as more drugs enter the market. In the generic market, where drugs can generally be substituted, FDA analysis found that for products with a single generic producer, the generic average manufacturer price is 39 percent lower than the brand average manufacturer price before generic competition. As more producers enter the market, data show generic prices continue to drop. With two competitors, prices are 54 percent lower; with four competitors, they are 79 percent lower; and with six or more competitors, price reductions are greater than 95 percent compared to brand prices.<sup>34</sup> This increased competition drives generic prices towards the cost of production and reduces profit margins for the producer.

In addition to this competition on price between generics, the various private financial/contractual arrangements that drive the distribution of finished drug products, which are outside the purview of the FDA, may also contribute to further pressures on price. Over the past few decades, sectors of the health care system, including hospital systems, GPOs, wholesalers, and the pharmaceutical industry, have consolidated to achieve efficiencies and increase negotiating power with suppliers and customers. For example, GPOs have consolidated their market power, so that by 2018, the four largest GPOs accounted for about 90 percent of the market for medical supplies in the United States.<sup>35</sup> As a result, GPOs have been able to negotiate low prices, especially for multi-source generics.<sup>36</sup>

In preparing its recent report on drug shortages, FDA hosted a public meeting, held listening sessions with stakeholders, and established a docket to receive public comments.<sup>37</sup> Through these forums, manufacturers of generic drugs expressed that current contracting practices create a high level of business uncertainty because they generally do not guarantee that a certain volume of products will be purchased at an agreed-upon price.<sup>38</sup> FDA heard from stakeholders that some contracts currently include “low-price clauses” that allow GPOs to unilaterally walk away from a contract if a competing manufacturer is willing to supply the

---

<sup>34</sup> Conrad, R and R Lutter, U.S. Food and Drug Administration. *Generic Competition and Drug Prices: New Evidence Linking Greater Generic Competition and Lower Generic Drug Prices*. December 2019. Available at: <https://www.fda.gov/media/133509/download>. Accessed on 4/9/2021.

<sup>35</sup> Bruhn et. al, 2018, Group Purchasing Organizations, Health Care Costs and Drug Shortages, *JAMA*: <https://www.ncbi.nlm.nih.gov/pubmed/30347037>. Accessed on 4/2/2021.

<sup>36</sup> U.S. Food and Drug Administration, *Drug Shortages: Root Causes and Potential Solutions* (p. 21), 2019, updated 2020. Available at: <https://www.fda.gov/media/131130/download>. Accessed on 4/5/2021.

<sup>37</sup> On November 27, 2018 FDA hosted a public meeting, “Identifying the Root Causes of Drug Shortages and Finding Enduring Solutions,” with the Robert J. Margolis, MD, Center for Health Policy, to solicit stakeholders’ perspectives on the forces driving shortages and potential interventions. In connection with the public meeting, FDA established a docket to receive public comments. In addition, FDA held a series of listening sessions in September and October 2018 with members of academia, medical societies, pharmacists’ associations, patient advocates, manufacturers, GPOs, and drug distributors. FDA also met individually with several concerned stakeholders representing hospitals, physicians, intermediaries (GPOs), and the pharmaceutical industry.

<sup>38</sup> U.S. Food and Drug Administration, *Drug Shortages: Root Causes and Potential Solutions* (p. 41), 2019, updated 2020. Available at: <https://www.fda.gov/media/131130/download>. Accessed on 4/5/2021.

same product or bundle of products for a lower price.<sup>39</sup> Prevalent contracting practices such as these often constrain the ability of manufacturers to raise their prices, while leaving them open to price challenges from competitors who may try to undercut them to gain market share. When confronted with a price challenge, the manufacturer usually has a choice of either meeting the challenge by lowering its price or losing market share. As a result, generic drug manufacturers may face “a race to the bottom”, and in some cases, end up selling the drug at or below its cost to manufacture.<sup>40</sup> Such economic pressures likely limit resources to invest in manufacturing or redundant capacity for these generic drugs.

In addition, GPO contracting practices may lead to limits in diversification of supply. GPOs may contract with certain manufacturers that are willing to pay to become a sole supplier. GPOs may also further link discounts to hospitals to sole supplier contractual arrangements.<sup>41</sup> These two practices can lead to one or two manufacturers serving an entire regional or national supply chain. A 2012 House Staff Report on drug shortage noted that GPO contracts, which are structured to take advantage of large economies of scale in drug production, can lead to only a few large manufacturers producing each generic injectable medication.<sup>42</sup> This 2012 report concluded that because of GPO contracting and the Medicare Modernization Act, which reduced reimbursement for injectable medications, individual generic injectable drugs were being produced by at most three companies. In 2010, 90 percent of generic injectable oncology drugs were produced by three or fewer manufacturers.<sup>43</sup>

Trends in a study of the generic market from 2004 to 2016 show that median number of generic manufacturers per molecule active ingredient/route of administration is typically two or smaller which suggests that mature U.S. generic drug markets should be considered in steady state and typically to involve only a small number of generic competitors. This same study found significant turnover in the market, and since 2011, more generic manufacturers exiting the market than entering over that period of time.<sup>44</sup> If a single facility has a production issue and needs to shut down manufacturing, the supply chain can be put at risk.

When competition is generally based on price alone, and there are other market forces keeping prices low, manufacturers will generally minimize production costs. This places economic pressure on manufacturers' ability to make large investments to modernize quality systems, such as refurbishing or rebuilding aging facilities. However, FDA does not have data showing whether this pressure to reduce production cost has affected the quality of marketed drugs. A study of 252 drug products (35 brand-name and 217 generic) met all U.S. market standards for production and use, indicating no meaningful difference in quality between generic products and their branded counterparts.<sup>45</sup> However, a lack of sufficient investment in modern quality management systems may render such drugs more susceptible to manufacturing disruptions that pull drugs off the market and lead to supply issues.

### *Low Geographic Diversity*

Lack of geographic diversity, including when production is concentrated in a single geographic area due to tax or economic incentives, can also leave even a domestic supply chain vulnerable to natural or other disasters. In 2017, Hurricanes Maria and Irma affected drug manufacturing facilities in Puerto Rico. At the time, it was

---

<sup>39</sup> *Ibid*, page 8.

<sup>40</sup> *Ibid*, page 22.

<sup>41</sup> Bruhn et. al, 2018, Group Purchasing Organizations, Health Care Costs and Drug Shortages, JAMA: <https://www.ncbi.nlm.nih.gov/pubmed/30347037>. Accessed on 4/2/2021.

<sup>42</sup> FDA's Contribution to the Drug Shortage Crisis, Staff Report U.S. House of Representatives 112th Congress Committee on Oversight and Government Reform, June 15, 2012 <https://republicans-oversight.house.gov/wp-content/uploads/2012/06/6-15-2012-Report-FDAs-Contribution-to-the-Drug-Shortage-Crisis.pdf>. Accessed on 4/2/2021.

<sup>43</sup> *Ibid*.

<sup>44</sup> Specifically, the authors found that generic entry rates increase from 2006 until 2013, and then decrease, while generic exit rates generally increase until 2011, and are flat thereafter. Berndt et al, 2017.

<sup>45</sup> Fisher, AC, A Viehmann, et al., Quality Testing of Difficult-to-Make Prescription Pharmaceutical Products Marketed in the US 2020 JAMA doi:10.1001/jamanetworkopen.2020.13920.

estimated that 10 percent of drugs consumed by Americans, including a number of top-selling patented drugs, were manufactured on the island. In addition to the tragic deaths and other devastation to the population of Puerto Rico caused by Hurricane Maria, several shortages worsened due to the hurricane impact, including the shortage of intravenous fluids, expanding the impact beyond Puerto Rico alone.<sup>46</sup>

In 2016, an explosion at a factory of the Chinese Qilu Pharmaceutical resulted in suspension of operations. The factory was the sole global manufacturer of several APIs for piperacillin-tazobactam (Zosyn), a critical antibiotic used in hospitals and for which there was already a shortage.<sup>47</sup> This disruption exacerbated the shortage, and per one source, led to substitution of other antibiotics that were broader spectrum. Per one study, the shift to other antibiotics, some of which were considered higher risk, also led to increases in *Clostridium difficile* infections, a serious and sometimes deadly infection.<sup>48</sup>

#### *Single Source Supplier and Limited Redundancy*

Due to consolidation in overall production of APIs and FDFs outside of the United States, the supply chain is vulnerable to changes in geopolitics, natural disasters, or other disruptions (e.g., due to climate change) that could occur in one country but reverberate throughout the supply chain.

In addition, a limited number of manufacturers per drug also leads to risks. As noted above, the median number of drug manufacturers per a unique drug/dosage form<sup>49</sup> is between two and three, indicating highly concentrated markets.<sup>50</sup> Furthermore, the share of drug-product markets in both oral and non-orally formulated categories supplied by two or fewer manufacturers grew over this time period but is more pronounced among non-orally formulated drugs.<sup>51</sup> Compounding this, the U.S. generic drug industry is populated by numerous relatively small firms, each manufacturing a limited number of drugs generating modest annual revenues, which may lead to more cost pressures. This is not representative of the entire industry; as the report noted, there are a small number of generic products and firms that hold many more ANDAs and have greater revenues.<sup>52</sup> However, as previously noted, manufacturers of older generic drugs face intense price competition, uncertain revenue streams, and, for certain sterile products, high investment requirements, all of which limit potential returns and lead to industry consolidation.<sup>53</sup>

---

<sup>46</sup> U.S. Department of Homeland Security, *The Public-Private Analytic Exchange Program Research Findings, Threats to Pharmaceutical Supply Chains*, 2018. (AEP). Available at: [https://www.dhs.gov/sites/default/files/publications/2018\\_AEP\\_Threats\\_to\\_Pharmaceutical\\_Supply\\_Chains.pdf](https://www.dhs.gov/sites/default/files/publications/2018_AEP_Threats_to_Pharmaceutical_Supply_Chains.pdf). Accessed on 4/2/2021.

<sup>47</sup> Oehler, R., S. Gomp, *Viewpoint: Shortcomings in the US Pharmaceutical Supply Chain Potential Risks Associated With International Manufacturing and Trade-Related Tariffs 2020* JAMA doi:10.1001/jama.2020.1634.

<sup>48</sup> Ibid.

<sup>49</sup> The authors grouped product market by molecule active ingredient and a unique route of administration, aggregating over difference dosages and strengths. Conti, RM and E Berndt, 2019, *Four Facts Concerning Competition in U.S. Generic Prescription Drug Markets*, The National Bureau of Economic Research, NBER Working Paper No. 26194. <https://www.nber.org/papers/w26194>.

<sup>50</sup> FDA's 2019 Report on Drug Shortages: Root Causes and Potential Solutions, citing Conti, RM and E Berndt, 2019, *Four Facts Concerning Competition in U.S. Generic Prescription Drug Markets*, The National Bureau of Economic Research, NBER Working Paper No. 26194. <https://www.nber.org/papers/w26194>. Accessed on 4/9/2021.

<sup>51</sup> Berndt, E, et al., *The Landscape of U.S. Prescription Drug Markets*, NBER Working Paper No. w23640. Available at: [https://www.nber.org/system/files/working\\_papers/w23640/w23640.pdf](https://www.nber.org/system/files/working_papers/w23640/w23640.pdf). Accessed on 4/2/2021.

<sup>52</sup> Most ANDA sponsors hold small portfolios of ANDAs with the median number being one. However, a small number of ANDA sponsors each holds hundreds if not thousands of ANDAs. Conti, RM and E Berndt, *Four Facts Concerning Competition in U.S. Generic Prescription Drug Markets*, NBER Working Paper No. 26194. Available at: <https://www.nber.org/papers/w26194>. Accessed on 4/2/2021.

<sup>53</sup> U.S. Food and Drug Administration, *Drug Shortages: Root Causes and Potential Solutions* (p. 21), 2019, updated 2020. Available at: <https://www.fda.gov/media/131130/download>. Accessed on 4/5/21.

## Limited Resilience

### *Obstacles to Expanding Production*

The pharmaceutical supply chain has difficulty responding to disruptions. Shifting from an unreliable third-party source can take months and expanding manufacturing capacity is costly and requires investment and time to obtain regulatory approvals. If a manufacturer perceives a need to increase production, the easiest approach is to increase output from an existing production line in an existing facility. While this would not likely require a significant change in material or processing conditions, and the manufacturer would be able to effect this change, likely without regulatory involvement of any type, the manufacturer is unlikely to have unused capacity available and would almost certainly need to stop producing another drug.

If a new facility or a significant change in manufacturing conditions (e.g., new API supplier or change in formulation or processing conditions to enhance throughput) is needed, the manufacturer would need to validate the change with the appropriate regulatory body, which requires proving the change is controlled and leads to an equivalent safe and effective drug. One of the biggest challenges the manufacturer might need to address is gaining approval in all countries where the drug will be marketed and where such a requirement exists. The manufacturer may choose not to make the change or may delay implementing the change until all markets have approved the proposal. Additional challenges include ensuring all material suppliers can produce at the higher level of output and in the timeframe needed to address the demand.

### *COVID-19 Exacerbated Vulnerabilities in the Drug Supply Chain*

The COVID-19 public health emergency laid bare new and long-standing drug supply chain vulnerabilities. As the pandemic unfolded, the United States faced an urgent need for many generic medications used routinely in hospitals, including for the most critically ill patients. The raw materials and APIs for many of those medications are predominantly manufactured overseas. Complex global supply chains lacked the agility to respond quickly to increased demand. Foreign export restrictions on finished drugs and APIs may have contributed to stress on the supply of some critical COVID-19 treatment drugs (including anti-infective products), as well as hormone medications and vitamins.

**Vulnerabilities in the supply chain led to widespread shortages of drugs critical for treating COVID-19 patients in acute and intensive care settings.**

Beginning in March 2020, HHS (including the Assistant Secretary for Preparedness and Response (ASPR) and FDA) worked with the Federal Emergency Management Agency (FEMA), the Department of Commerce (Commerce), the Department of Justice (DOJ) Drug Enforcement Agency, and the Department of Defense (DOD) to identify key starting materials (KSMs) made within the United States, including the starting material for API production and FDFs to the point of origin. Together, these departments used this information to identify KSMs, APIs, and FDF drugs that the United States does not produce at scale domestically, and developed a sourcing strategy to mitigate foreign supply chain dependencies.

The COVID-19 pandemic also highlighted other challenges in monitoring drug supply as it greatly increased regional variation in the availability of critical medicines for treatment of COVID-19 and its medical sequelae. To respond to this critical need, FDA developed the COVID-19 Drug Monitoring Portal, which requests information on a voluntary basis from hospitals on the frontlines of COVID-19, even when those drugs are not in nationwide shortage. Many of the drugs specifically targeted are drugs included on the FDA Essential Medicines List generated in response to *E.O. 13944*. Indeed, this outreach also informed FDA's assessment of the medications that are essential to have on hand in the case of a public health emergency.

Another risk to the supply chain is products that do not meet quality standards. Even when FDA identifies the original source of a problem, it can be difficult to remove products from the market in order to protect patients. For example, during the COVID-19 pandemic, hand sanitizer products contaminated with

methanol led to the death of over 20 people in the United States. FDA quickly engaged manufacturers and asked them to recall contaminated products. While some manufacturers voluntarily recalled these products immediately, others did so after a delay or chose not to recall the products, and FDA had no authority to mandate a recall in such instances. Some manufacturers may have economic incentives to keep their product on the market if possible, even if that risks patient or consumer harm. As a result, the products containing dangerous ingredients were on the market for a longer period of time, increasing patients' exposure to significant health risks.

### *Dependence on Foreign Nations and Anti-Competitive Actions*

Dependence on foreign nations has been cited as a key vulnerability for the U.S. drug supply chain. Specifically, foreign governments can leverage this dependency by interrupting the United States' access to these supply chains. Therefore, the supply of drugs and the health of American citizens dependent upon these drugs are vulnerable to the geopolitical strategies of foreign governments.

The U.S. pharmaceutical supply chain is dependent on China's continued supply of API. Based on U.S. trade data, in 2020, the United States imported \$1.8 billion in APIs from China and \$582 million from India, the second and eighth highest sources, respectively. With regard to FDFs, the United States imported \$7.9 billion in FDFs from India and \$1.4 billion from China, the 5<sup>th</sup> and 16<sup>th</sup> largest exporters to the United States, respectively. As of 2018, China ranked second among countries that export drugs and biologics to the United States by import line (13.4 percent).<sup>54</sup> An import line is a distinct regulated product within a shipment through customs. A single shipment may include multiple lines of varying sizes. Approximately 83 percent of these Chinese import lines for drugs and biologics were human FDFs, and 7.5 percent were APIs; the remaining 10 percent were animal drugs and medicated animal feed.

APIs manufactured by China also come to the United States as part of finished drug products manufactured in other countries, such as India. According to one source, India, which supplies approximately 40 percent of generic pharmaceuticals used in the United States, imports nearly 70 percent of its APIs from China. According to comments in response to Docket No. BIS-202-0034,<sup>55,56</sup> Tigura Pharmaceuticals quoted reports that the Government of India estimated that they are 70 percent reliant on their intermediate chemicals from China and a study that Europe imports 90 percent of their generic API from China.<sup>57,58</sup> Therefore, the percentage of APIs produced by China for the U.S. marketplace is likely underrepresented by trade numbers because China is a major supplier of APIs for other countries.<sup>59</sup> Dependence on overseas suppliers leaves the United States vulnerable to supply interruptions and shortages without the agility to respond to sharp increases in demand over a short period of time.

Examples of generic drug categories made in China and sold in the United States include antibiotics, anti-depressants, oral contraceptives, chemotherapy for cancer treatment for children and adults, and medicines for Alzheimer's, HIV/AIDS, diabetes, Parkinson's, and epilepsy, to name a few. One often-cited example is

---

<sup>54</sup> Exploring the Growing U.S. Reliance on China's Biotech and Pharmaceutical Products, Testimony of Mark Abdo, Associate Commissioner for Global Policy and Strategy - Food and Drug Administration, July 31, 2019. Available at: <https://www.fda.gov/news-events/congressional-testimony/exploring-growing-us-reliance-chinas-biotech-and-pharmaceutical-products-07312019>. Accessed on 4/2/2021.

<sup>55</sup> 85 Fed. Ref. 77428 (December 23, 2020).

<sup>56</sup> Notice of Request for Public Comments on Condition of the Public Health Industrial Base and Recommend Policies and Actions to Strengthen the Public Health Industrial Base to Ensure Essential Medicines, Medical Countermeasures, and Critical Inputs Are Made in the United States, Docket No. BIS-2020-0034.

<sup>57</sup> 'Indian government moves on APIs, as Chinese supplies are returning'. *The Pharma Letter*, April 1 2020. Available at: <https://www.thepharmaletter.com/article/indian-government-moves-on-apis-as-chinese-supplies-are-returning>. Accessed 5/9/2021.

<sup>58</sup> Brunsten, J. and M Peel, 2020. 'Covid-19 exposes EU's reliance on drug imports' *Financial Times*, 20 April. Available at <https://www.ft.com/content/c30eb13a-f49e-4d42-b2a8-1c6f70bb4d55>. Accessed 5/9/2021.

<sup>59</sup> Exploring the Growing U.S. Reliance on China's Biotech and Pharmaceutical Products, Testimony of Mark Abdo, Associate Commissioner for Global Policy and Strategy - Food and Drug Administration, July 31, 2019. Available at: <https://www.fda.gov/news-events/congressional-testimony/exploring-growing-us-reliance-chinas-biotech-and-pharmaceutical-products-07312019>. Accessed on 4/2/2021.

penicillin G, used for most forms of syphilis and rheumatic fever. A survey of 114 countries and territories in 2014–2016 found that 39 had shortages of penicillin G.<sup>60</sup> It was noted that this sterile injectable was reimbursed at pennies per dose for manufacturers. The manufacturing of API for this product is concentrated in China, with three of the four companies that manufacture the APIs in China, and one in Austria.<sup>61</sup> According to one report, India exited the market for penicillin G production because it became financially unviable to compete with China's low price.<sup>62</sup>

Concentration of API in China may also result from state actions to increase market share. Per testimony before the U.S.-China Economic and Security Review Commission, penicillin has not been made in the United States since 2004,<sup>63</sup> which has been attributed to a broader active strategy by Chinese companies to sell product on the global market at below-market price, which drove U.S., European, and Indian producers out of the business. Once the Chinese companies gained dominant global market share, prices increased. As a result of this strategy, not only have prices risen, but the United States does not have current domestic production capacity for many generic antibiotics for children's ear infections, strep throat, pneumonia, urinary tract infections, sexually transmitted diseases, Lyme disease, superbugs, and other infections that are threats to human life.<sup>64</sup> For example, after the anthrax attacks on Capitol Hill and elsewhere in 2001, it was reported that the U.S. government needed to turn to a European company to buy millions of doses of the recommended treatment for anthrax exposure, ciprofloxacin.<sup>65</sup> That company had to buy the chemical starting material from China.<sup>66</sup>

This consolidation of production to low-cost countries is also driven by increasing pressure to acquire products at the lowest cost possible, which for drugs like antibiotics has led to companies focusing production on products that have higher profit potential. For example, while on-patent antibiotics collectively generate \$4.7 billion in global sales annually, a single cancer medicine can generate twice that revenue annually.<sup>67</sup> When profit margins are lower on patented products, there are fewer incentives for multiple generic companies to enter the market. Additionally, shortages of products like antibiotics can have effects beyond patient access; doctors may use inferior products that are not as effective, leading to longer hospital stays, greater burdens on the health care system, and in the case of antibiotics, potentially additions to growing antimicrobial resistance globally.<sup>68</sup>

---

<sup>60</sup> Nurse-Findlay, S. et al. Shortages of benzathine penicillin for prevention of mother-to-child transmission of syphilis: An evaluation from multi-country surveys and stakeholder interviews. *PLOS Med.* 14, e1002473 (2017).

<sup>61</sup> Oehler, R, S Gomp, Viewpoint: Shortcomings in the US Pharmaceutical Supply Chain Potential Risks Associated With International Manufacturing and Trade-Related Tariffs 2020 *JAMA* doi:10.1001/jama.2020.1634.

<sup>62</sup> Guimaraes K. Why is the world suffering from a penicillin shortage? Posted May 21, 2017. Accessed November 1, 2019. <https://www.aljazeera.com/indepth/features/2017/05/world-suffering-penicillin-shortage-170517075902840.html>.

<sup>63</sup> Hearing on “Exploring the Growing U.S. Reliance on China's Biotech and Pharmaceutical Products” Wednesday, July 31, 2019, Rosemary Gibson testimony <https://www.uscc.gov/hearings/exploring-growing-us-reliance-chinas-biotech-and-pharmaceutical-products>. Accessed on 4/5/2021.

<sup>64</sup> Hearing on “Exploring the Growing U.S. Reliance on China's Biotech and Pharmaceutical Products” Wednesday, July 31, 2019, Rosemary Gibson testimony <https://www.uscc.gov/hearings/exploring-growing-us-reliance-chinas-biotech-and-pharmaceutical-products>. Accessed on 4/5/2021.

<sup>65</sup> <https://www.washingtonpost.com/archive/politics/2001/10/20/drug-firm-plays-defense-in-anthrax-scare/aa3b0b39-2cb3-4264-a360-aed1babbe8f8/> CNN, October 24, 2001, <https://www.cnn.com/2001/HEALTH/conditions/10/24/anthrax/index.html>.

<sup>66</sup> Hearing on “Exploring the Growing U.S. Reliance on China's Biotech and Pharmaceutical Products” Wednesday, July 31, 2019, Rosemary Gibson testimony <https://www.uscc.gov/hearings/exploring-growing-us-reliance-chinas-biotech-and-pharmaceutical-products>. Accessed on 4/5/2021.

<sup>67</sup> Shortages, Stockouts, and Scarcity. Available at: <https://accesstomedicinefoundation.org/publications/shortages-stockouts-and-scarcity-the-issues-facing-the-security-of-antibiotic-supply-and-the-role-for-pharmaceutical-companies>. Accessed on 4/9/21.

<sup>68</sup> *Ibid.*

**An estimated 43.1 percent of heparin and its salts imported into the United States come from China. An estimated 75 percent of all U.S. heparin API is produced outside the United States.<sup>69</sup> In 2019, 35.9 percent of antibiotics imported into the United States came from China.<sup>70</sup>**

### **Current Tools to Address Shortages**

Once a shortage or supply disruption is identified, FDA has several tools to respond, including:

- Working with the manufacturer of a product on actions they are willing and able to take to avoid or mitigate the shortage. This could involve FDA exercising temporary regulatory flexibility and discretion under certain conditions if there is a quality issue involved that would not lead to an unacceptable clinical risk. (Examples of unacceptable clinical risks may include a lot being out of specification or contamination by a harmful impurity). Any exercise of temporary regulatory flexibility and discretion in this manner involves thorough review by all relevant experts.
- Working with the approved manufacturer on any changes in specifications or additional lines, sites, or suppliers, and expediting review of these submissions as part of FDA's process to mitigate shortages.
- Determining whether there are any pending ANDAs that could be expedited and considering whether there are discontinued applications or applications not currently being marketed that firms could re-launch or launch.
- For a product in distribution nearing expiry, working with the approved manufacturer on whether they have data to extend expiry on specific lots and post the lot numbers and new dating in the database on FDA's website.
- Currently, when U.S. manufacturers are not able to resolve a shortage immediately and the shortage involves a critical drug needed for U.S. patients, FDA may consider not objecting to an FDA-registered firm's temporary importation of a product that is not approved for distribution in the United States. In these circumstances, FDA considers a range of criteria to evaluate the product's safety and efficacy. These criteria include the formulation and other attributes of the drug, as well as the quality of the registered establishment where the drug is manufactured. FDA also encourages any firms temporarily importing a drug in these circumstances to apply to add an approved source to the market.
- In a public health emergency, issuing emergency use authorizations for therapeutics used to treat critically ill patients when the supply of the approved alternatives is insufficient to fully meet the emergency need (e.g., renal replacement solution and propofol.)
- Outsourcing facilities under Section 503B of the FD&C Act, which may be an important alternative source to help mitigate a shortage of an approved product.

From March 2020 through September 2020, FDA expedited review and approved more than 31 original ANDAs for drugs used in the treatment of patients with COVID-19 and more than 534 ANDA supplements under the COVID-19 prioritization programs. FDA also exercised regulatory flexibility (e.g., temporary packaging or labeling changes, temporary importation of product intended for foreign market, product manufactured at an alternate site) more than 35 times to increase availability of critically needed medications that were in short supply, including heparin, albuterol, etomidate, midazolam, propofol, and others. FDA also expedited assessments of manufacturing supplements to facilitate manufacturing capacity for COVID-19 therapeutic biologics.

---

<sup>69</sup> Congressional Research Service, *COVID-19: China Medical Supply Chains and Broader Trade Issues*, Updated December 23, 2020. <https://crsreports.congress.gov/product/pdf/R/R46304>, Accessed on 5/25/21.

<sup>70</sup> Ibid.



## Surveillance Enhancements Implemented During the Pandemic

The HHS Supply Chain Control Tower (SCCT) was established in March 2020 to provide visibility into critical medical supply chains to support U.S. Government decision-making and actions on planning, acquisition, prioritization, allocation, and targeted distribution to get supplies where they are needed. The SCCT program leverages information from manufacturers, distributors, and healthcare providers, as well as U.S. Government entities such as the Strategic National Stockpile and FEMA, to monitor the availability and supply of critical medical products—including select personal protective equipment, pharmaceuticals, new COVID-19 therapeutics, point-of-care tests, and needles and syringes.

For pharmaceuticals, the SCCT program tracks commercial distribution of more than 40 existing drugs and new therapeutics that are used in the treatment of patients with COVID-19. The distribution data are voluntarily provided by four distributors who collectively represent approximately 90 percent of the U.S. pharmaceutical distribution market. These distributors provide near-daily transaction-level information on orders, shipments, and inventories that are ingested, standardized, and aggregated into datasets and visualizations that reside on HHS Protect.<sup>71</sup> In addition, the SCCT program integrates information reported weekly by approximately 5,000 hospitals on their ability to obtain and maintain medications that support patients requiring the highest level of acute care, including ventilatory support; any requests for support from state, local, Tribal, and territorial governments to the Strategic National Stockpile or FEMA for pharmaceuticals; and information from FDA's drug shortages database. It is unclear whether this voluntary sharing of data will be available beyond the public health emergency.

### Risks Most Likely to Impact the Supply Chain

In sum, multiple factors can cause vulnerability in the drug supply chain, including:

- The complexity, vastness, and multinational nature of drug supply chains and corresponding overdependence on foreign entities who may prioritize national interests above trade in an emergency.
- Effect of economic pressures and other market influences.
- Reduced incentive for existing manufacturers to invest in upgrading equipment, improving supply chains, or expanding capacity.
- Lack of redundant capacity in manufacturing.
- Just-in-time inventory management practices that limit inventory and reduce the ability to respond to surges in demand.
- Geographic concentration of manufacturers that puts production at risk from natural disasters or climate change that can quickly affect an entire region.

In addition, consolidation of generic drug manufacturing is driven by multiple factors, including:

- Low volume and margins for many generic drugs, resulting in difficult economic conditions for new entrants.
- Anticompetitive actions by certain countries to obtain market share.
- More manufacturers exiting the market than entering it.

## GLOBAL FOOTPRINT

Several regulatory partners have also initiated review of actions that can be taken to build and strengthen their supply chain, opening potential opportunities to align and create synergy for a robust supply chain.

The European Commission (EC) recently issued a Pharmaceutical Strategy for Europe. In addition to being described as a plan to increase access to affordable medications, the Strategy is also characterized as “complementary to the European Green Deal and more particular the Zero Pollution ambition for a toxic-

---

<sup>71</sup> The HHS Protect ecosystem is a secure platform for authentication, amalgamation, and sharing of healthcare information, so that the U.S. Government can harness the full power of data for the COVID-19 response.

free environment, notably through the impact of pharmaceutical substances on the environment” The Strategy is comprehensive and includes investment in

development of new pharmaceuticals (including new antimicrobials), frameworks for evidence generation, and use of digital technologies. With respect to supply chains, the Strategy states that:

Building up **EU’s open strategic autonomy** in the area of medicines requires actions to identify strategic dependencies in health, and to propose measures to reduce them, possibly including by diversifying production and supply chains, ensuring strategic stockpiling, as well as fostering production and investment in Europe. Minimizing the impact of medicines shortages on patient care will require both preventative and mitigating measures to significantly reinforce the obligation of continuous supplies.

In addition to committing to a study of the root causes of shortages, the Strategy notes a commitment to:

... enhanced cooperation between Member States, for example improved procurement approaches and strategies, joint procurement for critical medicines and EU-level cooperation on tools and instruments for national policy making on prices and reimbursement. For products with small volumes or limited use, new business contracting and/or payment models will be crucial.

Finally, the Strategy outlines a series of structured dialogues.<sup>72</sup> The EC will therefore initiate and steer a structured dialogue with the pharmaceuticals manufacturing value chain, public authorities, patient and health nongovernmental organizations, and the research community. Per the report:

[In] its first phase, the structured dialogue will aim to gain a better understanding of the functioning of global supply chains and identify the precise causes and drivers of different potential vulnerabilities, including potential dependencies threatening the supply of critical medicines, active pharmaceutical ingredients and raw materials based on data collection and analysis. In a second phase, the structured dialogue will serve to put forward a set of possible measures to address the identified vulnerabilities and formulate policy options to be considered by the Commission and other authorities in the EU to ensure the security of supply and the availability of critical medicines, active pharmaceutical ingredients and raw materials.

In addition to regulatory partners, pharmaceutical industries in other countries are taking actions related to the supply chain. In Europe, Sanofi is creating what it has billed as the world’s second-largest API manufacturer, EUROAPI, with sales expectations of over \$1 billion by 2022.<sup>73</sup> Although reportedly not directly prompted by the COVID-19 pandemic, the move is nevertheless expected to play a role in easing European drug makers’ dependence on supplies of raw materials from China and India.

The Canadian Generic Pharmaceutical Association set out its own detailed “blueprint” document in mid-2020, calling for fresh investment in domestic manufacturing and insisting that an enhanced international role is needed for Canada, as well as urging engagement with Canadian manufacturers to create a local stockpile of essential drugs.<sup>74</sup>

---

<sup>72</sup> European Commission, Structured dialogue on security of medicines supply. Available at: [https://ec.europa.eu/health/human-use/strategy/dialogue\\_medicines-supply\\_en](https://ec.europa.eu/health/human-use/strategy/dialogue_medicines-supply_en). Accessed on 4/15/20.

<sup>73</sup> Sanofi API Unit Expects \$1bn Sales By 2022. Generics Bulletin, 28 Feb 2020. Available at: [https://generics.pharmaintelligence.informa.com/GB149658/Sanofi-API-Unit-Expects-\\$1bn-Sales-By-2022](https://generics.pharmaintelligence.informa.com/GB149658/Sanofi-API-Unit-Expects-$1bn-Sales-By-2022). Accessed on 4/2/2021. See also Sanofi Press Release, “SANOFI unveils EUROAPI as the name of the new industry leading European API company and appoints Karl Rotthier as its future Chief Executive Officer” <https://www.sanofi.com/en/media-room/press-releases/2021/2021-01-12-14-30-00>. Accessed on 4/2/2021.

<sup>74</sup> Canadian Body Calls for Investment in Domestic Production. Generics Bulletin, 18 Jun 2020. Available at: <https://generics.pharmaintelligence.informa.com/GB150002/Canadian-Body-Calls-For-Investment-In-Domestic-Production>. Accessed on 4/2/2021.

## OPPORTUNITIES & CHALLENGES

As mentioned above, the three pillars of a robust and resilient supply chain are quality, diversity, and redundancy. For FDA to be able to optimally exercise influence over the three pillars, FDA must have the appropriate tools to maintain oversight and awareness of the supply chain. The more insight FDA has into the supply chain, the better FDA is at identifying vulnerabilities and being able to proactively prevent and mitigate potential shortages, consistent with our statutory authorities.

### **Challenges with Monitoring the Supply Chain**

Although FDA has some insight into the drug manufacturing supply chain, certain limitations inhibit the ability to identify vulnerabilities in the supply chain. Under current law, unless otherwise exempt, all domestic establishments that manufacture, prepare, propagate, compound, or process ("manufacture") drugs, and all foreign establishments that manufacture drugs that are imported or offered for import into the United States are required to register their establishments and list the drugs they manufacture at those establishments. Additionally, holders of approved drug applications (i.e., those with an approved new drug application, biologics license application, or ANDA) are required to submit, in their annual report, information about the quantity of the drug that they distributed during the previous year. Although this information is useful to FDA, it does not provide sufficient insight into the supply chain to allow FDA to adequately monitor and identify vulnerabilities.

For example, many foreign API manufacturers that ship their drug to another foreign country to be incorporated into a finished product that is ultimately imported into the United States do not register their establishments with FDA. Additionally, the distribution volume information submitted by holders of approved drug applications only apply to products subject to an approved application; this information could be aggregated across all establishments where the drug product was made, if it was manufactured at multiple establishments, leaving FDA without visibility into which facilities are actually used to manufacture the finished drug product or APIs or the relative contribution of each facility.

For example, if an application were to identify two domestic and two foreign manufacturing establishments at which the drug product may be manufactured, FDA would not typically know which of these establishments are actually being used to produce the drug product nor the quantity that is produced by the respective establishments. It might be the case, for example, that 100 percent of the manufacturing takes place in one or both foreign establishments, and that the domestic facilities were included only as backups. Similarly, if the application lists multiple API suppliers, the applicant may source the overwhelming majority of APIs from just one of those suppliers, or a portion from each supplier. This can change over time depending on various business and supply considerations, and what appears to be a diversified and redundant supply chain can actually be more vulnerable than it appears if the operations of the dominant API or FDF manufacturer are affected by a quality issue or other event, such as a natural disaster.

Recently, Congress took action to fill some of these information gaps. Specifically, in the spring of 2020, Congress passed the Coronavirus Aid, Relief, and Economic Security (CARES) Act, which amended the FD&C Act to require drug manufacturers registered under Section 510 of the FD&C Act to report annually to FDA the amount of each listed drug they manufactured for commercial distribution. This additional information will improve FDA's insight into the supply chain; however, additional data could further improve FDA's ability to monitor the supply chain. For example, the data required to be submitted do not enable FDA to determine which drug product manufacturers are relying on a given API supplier, or how much of a manufacturer's API is being supplied by any given API supplier. Therefore, if an application holder has listed more than one API supplier in its application, FDA would not know whether the application holder is relying on each supplier equally or is only relying on a single supplier, making it difficult for FDA to predict how a disruption in one API supplier, or API suppliers from one region, will affect the manufacturer's ability to produce the drug products that require that API.

Without this level of transparency, FDA must still primarily rely on notifications from manufacturers about permanent discontinuances in the manufacturing of certain products and interruptions in manufacturing of

such products under Section 506C of the FD&C Act. These reports are generally required to be provided at least 6 months prior to the discontinuance or interruption; however, this is not always possible.<sup>75</sup> Although these reports are helpful, they are not a substitute for more complete insight on the status of the supply chain. Specifically, they do not require manufacturers to report increases in demand that could affect the supply of the drug.

Another factor affecting the ability to monitor the supply chain is that some foreign drug manufacturers fail to register their facilities because they do not ship the drugs they manufacture directly to the United States. This causes two important problems. First, because of the failure to register, FDA is not aware of these facilities and cannot incorporate them into the risk-based inspection model, thus hindering our ability to proactively monitor their ability to comply with Current Good Manufacturing Practice (CGMP) regulations. Second, the new volume reporting requirements that were added by the CARES Act are tied to establishment registration; therefore, if manufacturers do not register, they likely would not submit the manufacturing volume information to FDA, limiting the FDA's ability to identify vulnerabilities and assess the potential impact that could result from a disruption at these facilities.

Other factors also limit FDA's ability to appropriately monitor the quality of drugs entering the U.S. supply chain. For example, APIs and finished drug products do not always include the identity of the original manufacturer in their labeling. This can pose challenges when investigating drug products with potential quality problems and trying to determine the original source of the problem. This makes it difficult for FDA to fully assess the extent of a quality issue and the impact the quality issue may have on the supply chain.

In addition to manufacturing volume data, FDA's experience during COVID-19 highlights the potential utility of timely, accurate, and complete data related to demand that can be seamlessly integrated to provide early signals and allow for timely action. Specifically, during the COVID-19 pandemic, we saw how sudden, unexpected changes in demand can trigger or exacerbate a shortage. FDA has already started the process to bring its available data together and investigate how to best utilize advanced analytics and other tools to identify potential shortage signals so that proactive regulatory actions can be taken. However, the data currently available to FDA are not sufficient to build a system that allows for optimal, timely predictions or action.

## **Promoting Quality**

Most shortages have been related to manufacturing quality. The prescription drug market, especially for generic drugs but also for brand-name drugs, often does not provide incentives for manufacturers to invest in current manufacturing technologies and improvements in quality management. Continual technical improvement and updating is needed because facilities age, routine operations require updates to maintain a state of control, technology evolves, suppliers change, and scientific expectations may also change. A failure to implement such updates and improvements can lead to quality problems.

Historically, many pharmaceutical manufacturing firms have focused their efforts on compliance with CGMP, which include standards for production materials, equipment and facilities, production, laboratory, packaging and labeling, and quality control. These foundational standards, however, only set a minimum threshold that companies must achieve in order to be allowed to supply the U.S. marketplace. They do not include more advanced levels of quality management, which would aim to robustly detect vulnerabilities and address them to prevent the occurrence of problems, as well as establish a culture that rewards process and system improvements. As companies move from focusing on compliance with CGMP to institutionalizing continual process and system improvement efforts, they begin to advance in quality management maturity.

---

<sup>75</sup> When providing at least 6 months advanced notice is not possible because the discontinuance or interruption was not reasonably anticipated, manufacturers must report as soon as practicable thereafter, but in no case later than 5 business days after the discontinuance or interruption in manufacturing occurs. See section 506C(b) of the FD&C Act; 21 CFR 310.306(b), 314.81(b)(3)(iii)(b)(2), and 600.82(b)(2). For example, a planned site transfer may include several months of lead time before a shortage may occur, while the sudden shutdown of a facility or an identified product defect could result in no lead time.

Quality management maturity in the pharmaceutical industry is important for strengthening the supply chain. Some pharmaceutical firms have been slow to implement robust, mature quality systems and the accompanying quantitative measures of quality that have been the foundation of success in other industries, such as automotive and aerospace.<sup>76</sup> These industries exercise quality oversight by vigilantly monitoring ongoing process performance and product quality data, and promptly adjusting operations when needed. Numerous organizations and quality experts have worked to develop conceptual models and standards for advancing the maturity of industrial quality management systems. These models could be used more broadly in the pharmaceutical industry to improve supply reliability and shift from doing only what is necessary to meet CGMP to proactively focusing on achieving quality management maturity.

The work to prevent or mitigate shortages due to disruptions in manufacturing has highlighted the importance of strengthening quality management systems in manufacturing. Mature quality management starts with a foundational quality management system that not only conforms to CGMP but also builds in a performance and patient focus that utilizes technology, statistical process control, and planning activities to ensure a reliable supply of the drugs manufactured at the facility.

### **Promoting Diversification and Redundancy**

To build diversification and redundancy into the supply chain for pharmaceuticals and APIs, and to support national economic growth, a greater proportion of manufacturing of pharmaceuticals and APIs will need to occur in countries other than those with the lowest labor costs and least robust environmental frameworks (such as China and India). Using traditional pharmaceutical manufacturing technology, a domestic manufacturer generally could not offset the labor and other cost advantages of some foreign nations. However, advanced manufacturing technologies could enable United States-based pharmaceutical manufacturing to bolster its competitiveness with those of foreign countries and potentially ensure a stable supply of drugs critical to the health of U.S. patients, as well as increase good-paying American jobs. In spite of the benefits provided, the cost of adoption for advanced manufacturing processes remains a limiting factor for generic manufacturers that operate with much smaller profit margins, as opposed to the innovator market where higher profit margins enable such investment.

*Advanced manufacturing* is a collective term for innovative manufacturing technologies that can improve quality. Although widely used in other industries such as automotive, aerospace, and semiconductors, pharmaceutical companies are just beginning to use advanced manufacturing. Advanced manufacturing offers many advantages over traditional pharmaceutical manufacturing, including that, once implemented, it can be used far more cost-effectively than traditional manufacturing. If the United States invests in this technology, it could be used to reduce the Nation's dependence on foreign sources of APIs, increase the resilience of our domestic manufacturing base, and reduce quality issues that trigger drug shortages and recalls. For API and FDF manufacturing, new technologies include continuous manufacturing (CM), wherein the finished drug product is produced as a continuous stream, as opposed to traditional batch manufacturing, where breaks or stops exist between different processing steps. CM can improve pharmaceutical manufacturing by using an integrated process with fewer steps and shorter processing times, requiring a smaller equipment footprint, supporting an enhanced development approach (e.g., quality by design) and use of process analytical technology and models, enabling real-time product quality monitoring, and providing flexible operation to allow scale-up, scale-down, and scale-out in order to accommodate changing supply demands.

In sum, advantages of advanced manufacturing include:

- Product quality can be precisely controlled with modern automation and control systems and can be closely monitored during production by using high-resolution analytics.
- High technology, computer-controlled production facilities are better able to rapidly respond to changes in demand because they typically do not have the equipment scale-up issues associated with traditional methods and can be capable of seamlessly producing a variety of strengths and even dosage forms.

---

<sup>76</sup> Fuhr, Ted, et al., 2015, *Flawless—from Measuring Failure to Building Quality Robustness in Pharma*, McKinsey & Company.

- Advanced manufacturing platforms have a much smaller footprint than traditional manufacturing platforms, and the equipment can be made portable so that it can be moved closer to markets, reducing the need for transcontinental shipping of components.
- Over time, after initial investment, medicines can be produced at lower cost than by traditional methods.
- Advanced manufacturing requires a skilled workforce and can promote high-wage job growth for American workers.
- Environmental impact of manufacturing is significantly reduced.

To prioritize and prepare for advanced manufacturing, FDA formed an Advanced Manufacturing Regulatory Framework Working Group to identify gaps and potential regulatory pain points that could impede the approval of advanced manufacturing technologies. FDA also issued guidance for applicants seeking to use CM for small-molecule and solid oral drug products. In addition to guidance, FDA is actively engaged with international counterparts in harmonizing requirements to assist manufacturers who are interested in exploring advanced manufacturing. As part of this effort, an ad hoc committee of the National Academies of Sciences, Engineering, and Medicine recently published a consensus report<sup>77</sup> from a series of workshops describing (1) potential pharmaceutical applications of emerging technologies, (2) key technical issues that will affect innovation, (3) regulatory issues for which FDA might want to prepare, and (4) suggestions for how to overcome those regulatory issues to facilitate the adoption of promising novel technologies in the pharmaceutical industry.

### **FDA's CDER Emerging Technology Program and Other Activities**

FDA has taken steps to encourage and support the adoption of advanced manufacturing techniques, but more can be done. For example, in late 2014, FDA's CDER launched the Emerging Technology Program (ETP), which fosters close collaboration with industry to reduce barriers to entry for advanced manufacturing. ETP provides a gateway for early (pre-submission) discussions of innovative technologies and approaches, even before a candidate drug is identified. Under ETP, FDA/CDER received over 100 proposals, and accepted approximately 50 that span a wide range of innovative technologies applicable to drug delivery systems, as well as testing, quality control, and manufacturing of APIs and small-molecule and biological products. Examples include:

- CM: A manufacturing process that integrates two or more-unit operations together with a highly automated system to ensure a robust, uninterrupted continuous operation;
- End-to-end CM: A continuous process that integrates both API and drug product manufacturing;
- Portable and modular manufacturing platforms (e.g., Pharmacy on Demand);
- 3D printing technologies for solid dosage forms.; and
- A variety of novel analytical and drug delivery technologies.

As a result of this effort, between 2015 and 2020, FDA/CDER approved a total of 11 applications involving advanced manufacturing. Of these, eight applications involved CM for FDF manufacturing, one application involved CM in producing a high-selling (high-volume) API, one application used CM for making a biological product to treat a rare disease, and one application used 3D printing to manufacture rapidly dissolving pills. In 9 of these 11 approved applications, the drug manufacturers use modern manufacturing facilities incorporating advanced manufacturing technologies in the United States for their commercial production. Also, during the COVID-19 pandemic, FDA approved two supplemental applications that used advanced manufacturing in a U.S. facility to address the potential shortage of two critical drug products.

FDA also initiated an extramural research program to collaborate with academia and is building advanced manufacturing research facilities in Ammendale, Maryland and additional lab space in St. Louis, Missouri to

---

<sup>77</sup> National Academies of Sciences, Engineering, and Medicine. 2021. *Innovations in Pharmaceutical Manufacturing on the Horizon: Technical Challenges, Regulatory Issues, and Recommendations*. Washington, DC: The National Academies Press. <https://doi.org/10.17226/26009>.

support intramural research programs in advanced manufacturing. These research programs generate data and knowledge to support FDA application evaluation, inspection, policy, guidance development, workforce development, and training in advanced manufacturing.

Although the success to date demonstrates that the adoption of advanced manufacturing technology has the potential to enable domestic manufacturers to be competitive in the marketplace, the limited number of approved applications demonstrates that there are likely still barriers to entry beyond the regulatory barriers the ETP is designed to reduce. These could include logistical challenges, as well as lack of the sufficient skilled workforce and technical expertise to support broader development and implementation of advanced manufacturing processes for commercial production of pharmaceuticals. However, equally if not more important to consider, is the barrier created by insufficient, conflicting, or countervailing incentives for the industry.

During 2015 to 2020, FDA approved:

- Eight drug applications for using CM to make FDF products;
- One application for using CM for producing a high-selling (high-volume) API;
- One application for using CM to make a biological molecule to treat a rare disease; and
- The first application for using 3D printing to manufacture rapidly dissolving pills.

In nine of these applications, the drug manufacturers use advanced manufacturing technologies in the United States for commercial production.

### **FDA's Advanced Technologies Team for Vaccines and Other Complex Biologics**

Advanced manufacturing can help create a more agile and robust manufacturing environment with flexibility to ramp up the manufacture of biologics such as vaccines on short notice and rapidly modify them to address infectious diseases. It can also provide greater assurance that the biologic products manufactured will provide the expected clinical performance.

FDA's CBER also encourages the development and adoption of advanced technologies to modernize domestic biopharmaceutical manufacturing. FDA/CBER is currently supporting development of an advanced manufacturing platform for Messenger RNA (mRNA) vaccines to support the COVID-19 vaccination efforts. While the pilot for mRNA vaccines will be most directly in support of the COVID-19 response, this technology will also be applicable to other RNA-based therapeutics, such as antisense-RNA. Such a modernization effort aims to result in a more robust manufacturing process with fewer interruptions in production, fewer product failures (before or after distribution), and greater assurance that the biologic products manufactured will provide the expected clinical performance. FDA/CBER recognizes that the implementation of emerging technologies for manufacturing high-quality complex biologics could present a variety of challenges for both FDA/CBER and industry, making support from FDA a critical part of the effort.

To address these challenges, FDA established the CBER Advanced Technologies Team (CATT) in 2019. CATT provides an interactive mechanism for prospective innovators and developers of advanced manufacturing and testing technologies to discuss with FDA/CBER staff issues related to the implementation of these technologies in the development of CBER-regulated products. In addition, since 2018, FDA/CBER has awarded several grants and contracts that support research projects to study and recommend improvements for the advanced manufacturing of biological products, including the investigation and development of innovative monitoring and control techniques. The funded research addresses knowledge and experience gaps identified for emerging manufacturing and testing technologies and supports the development and adoption of such technologies in the biological product sector.

## Other HHS and Interagency Initiatives to Increase Diversity of Supply

In addition to actions taken above, HHS ASPR, in partnership with DOD, has recently established on-demand manufacturing capabilities for APIs and FDF drugs. These platforms have the potential to revolutionize the production of domestic pharmaceutical manufacturing through the use of novel synthetic chemistry processes that modernize flow chemistry, liquid-liquid extraction, and phase separation to produce any required APIs and continue to demonstrate scale production of essential medicines in shortage, beyond those used for COVID-19 patients. These investments in capability will immediately yield extremely cost-competitive production of critical pharmaceuticals in support of the Strategic National Stockpile, as well as allow for expansion to produce additional essential pharmaceuticals in support of national health care priorities.

In response to immediate needs related to the COVID-19 pandemic, ASPR is also establishing capabilities for production of saline and other supportive care fluids on demand in a modular, highly portable manufacturing platform. ASPR has also initiated the JUMPSTART initiative with DOD, establishing a U.S.-based, high-speed supply chain to produce 45 million pre-filled injectors (similar to a syringe) per month, using well-established Blow-Fill-Seal aseptic manufacturing technology. This manufacturing technology is currently undergoing 510(k) review (for substantial equivalence) and comparability/stability testing with COVID-19 vaccine products for FDA authorization. HHS and the U.S. International Development Finance Corporation are scaling this initiative in order to increase production capacities to 250 million devices per month, starting in early 2022, and ramping through 2023. HHS has also established the Foundry for American Biotechnology to produce technological solutions that help the United States protect against and rapidly respond to health security threats, enhance daily medical care, and add to the U.S. bioeconomy.

Furthermore, ASPR, through recent Defense Production Act (DPA) authorities given to it by Congress, is establishing a Plan of Action with FEMA and DOJ for the Manufacture, Allocation, and Distribution of Drug Products and Drug Substances to Respond to COVID-19 and Future Health Security Threats. This Plan will be implemented under the Voluntary Agreement to Define COVID-19 Drug Products and Drug Substances requirements. It will maximize the manufacture and efficient distribution of selected types of drug products and drug substances and will create a prioritization protocol for end-users based upon their demonstrated or projected requirements including geographic and regional circumstances.

## RECOMMENDATIONS

As this report details, the pharmaceutical supply chain is complex, global, and vulnerable to disruptions. The United States must undertake a comprehensive, multifactorial approach to induce sustained enhancements that drive resilience throughout the many interconnected elements of the supply chain. This will require the active participation of private sector players, including purchasers, intermediaries, and manufacturers, as well as the public sector. Solutions to address the reliability of the pharmaceutical and API supply chain should address the following two priority objectives:

- **Improve supply chain transparency and incentivize resilience.** Policies should seek to provide increased transparency to distributors and purchasers of the sources of drug manufacturing and the quality of the facilities that make them. Greater transparency will incentivize distributors and purchasers to shift to more resilient sources of supply. Policies should also establish mechanisms to reward supply chain resilience and reductions in the severity of drug shortages.
- **Increase the economic sustainability of U.S. and allied drug manufacturing and distribution.** U.S. and allied drug manufacturing, especially for generics and common drugs, is often undercut by low-cost competition, particularly from India and China. While the United States does not need to make every drug itself, it does need increased domestic production capacity for key drugs. Policy tools to increase the economic sustainability of U.S. and allied drug manufacturing include providing predictability in production costs, pricing, and volume sold; increasing government and private sector flexibility in contracting and sourcing of finished drugs and raw materials; and studying whether the current market



for finished drugs supports a diversification of supply instead of relying on one or two suppliers through preferred contractual arrangements.

As the United States promotes a more sustainable and resilient supply chain for APIs and finished drugs, policy tools should be guided by three overarching principles:

- **Rigorous assessment of benefits and costs:** While the United States needs a more resilient drug supply chain, the United States must also remain focused on controlling healthcare costs. Sustainable solutions to drug shortages and other supply chain vulnerabilities must be economically feasible and not have unintended consequences across the health care system. There may be initial upfront investments, the gains for which will not be realized for a number of years. While upfront costs may be easy to quantify, it is important to also quantify the projected long-term benefits that such investments are likely to generate. Benefits could include improved treatment outcomes when fewer drugs go into shortage, reduced staffing needs for monitoring and responding to drug shortages, reduced costs for purchasing alternative treatments, additional jobs, favorable environmental impacts, and the geopolitical advantages of reducing dependency on strategic competitors.
- **Distribution of benefits and costs across affected stakeholder groups.** Sustainable solutions to drug shortages and supply chain vulnerabilities should encourage stakeholders to not overly favor or penalize any one group. Several categories of stakeholders should be considered, including drug manufacturers, large and small; supply chain intermediaries such as GPOs, pharmacy benefit managers, and wholesalers; patients and health care providers such as hospitals and pharmacies; payers (both public and private); and workers at all levels of the supply chain. While individual policies may impact groups differently, overall policy solutions should be balanced in their impacts on different stakeholders.
- **Support market-based mechanisms that serve public health for drug production and distribution.** An enduring solution should avoid generating other adverse impacts that could undermine its success once implemented. These might include discouraging drug manufacturers from remaining in the marketplace, leading to shortages and adverse impacts on patients, contributing to stockpiling among drug purchasers, or disclosing commercial confidential information and trade secrets.

With those objectives in mind, we offer three sets of recommendations to promote domestic growth, equity, and resilience throughout the pharmaceutical supply chain:

- Boost local production and foster international cooperation;
- Build emergency capacity; and
- Promote international cooperation and partner with allies.

The first element of the strategy focuses on developing robust collaborative bodies to help increase domestic pharmaceutical production with large and small firms where appropriate, promoting international cooperation among allied nations to increase regulatory consistency and security throughout allied nations, and developing a safe and secure supply chain that does not predominantly rely on production in nations in which there may be more geopolitical risk. The second element of the strategy focuses on building emergency capacity through the development of a strategic stockpile that can be deployed in emergency situations to relieve immediate stress on the pharmaceutical supply chain. The third element of the strategy focuses on international cooperation and partnering with allies. The U.S. Government should work through already established international regulatory collaboration and harmonization organizations, and, as needed, other bilateral and multilateral fora and engagements to strengthen drug and API supply chain cooperation.

Many of these proposals will require dedicated funding, which will need to be determined as further details are established and will require future work with relevant U.S. Departments and Agencies, the Office of Management and Budget, and Congress, as well as the private sector and other non-governmental stakeholders.

## **Boost Local Production and Fostering International Cooperation**

The first pillar of our strategy is to boost U.S. production while fostering greater international cooperation, which both boosts U.S. supply chain resilience and the resilience of the supply chains of U.S. partners and allies. Boosting U.S. production will require a blended mix of targeted investments and financial incentives, research and development (R&D) to create new manufacturing technologies, greater supply chain transparency, and better data collection.

### **1. Investment and Financial Incentives to Boost Production**

#### *Leverage the DPA and Current Public-Private Partnerships (PPPs) to Establish a Consortium for Advanced Manufacturing and Onshoring of Domestic Essential Medicines Production*

There are thousands of pharmaceutical products available in the U.S. market, and most do not go into shortage, even during a pandemic. However, for those drugs that do go into shortage, the impact on individual health and the financial impacts for health care systems can be significant. The FDA's Essential Medicines List, developed pursuant to E.O. 13944, can be used as a starting point to prioritize efforts to improve resilience in the supply chain by serving as a "first cut" of the most important medicines to address supply chain vulnerabilities.

In order to seed investments to promote greater U.S. production and to develop new technologies that will reduce costs and increase the resilience of U.S. and allied production, the Administration will establish a new diverse consortium of stakeholders to help advise private sector companies looking to build domestic capacity. This consortium, to be established using Title 7 of the DPA, will be comprised of federal agencies with regulatory or other equities, headed by HHS and its operating divisions, and will include the Environmental Protection Agency, Commerce (including the National Institute of Standards and Technology), DOD, Department of Labor (DOL), Federal Trade Commission, U.S. International Development Finance Corporation, U.S. EXIM Bank, Department of Homeland Security, DOJ, and Small Business Administration, as well as private sector stakeholders either looking to build domestic production capacity or with the specialized experience to help facilitate it. The consortium will be tasked with helping to address the following challenges:

- Addressing regulatory questions presented by novel technologies and using the consortium to coordinate input from all necessary Government agencies.
- Identifying financial incentives or investment (both public and private) that can help drive private sector willingness to develop domestic production capacity, including evaluating the merits of a successor financing program to the DPA Loan Program.
- Providing sector-based training for American workers.<sup>78</sup>
- Developing a plan of action to incorporate more small and medium-sized firms in R&D to increase domestic technological capacity and capability.
- Limiting environmental impacts of manufacturing on communities located near facilities.
- Identifying and mitigating risk from climate change.

Taking into account public input, the new working group will prioritize those medications that are essential to have on hand in sufficient quantities to treat the U.S. population during a public health or other emergency. Working with the private sector, the working group will map the supply chains of key essential medications. Initial steps may focus on those medications for which the current supply chain does not have adequate redundancy or diversification, such as over-concentration in areas for which geopolitical or climate change risks could place supplies at risk. For those at most risk and that have no domestic manufacturing capacity,

---

<sup>78</sup> The DOL's Employment and Training Administration (ETA) could support sector-based pathways to jobs in the pharmaceutical sector to recruit and train workers for jobs requiring Associate's degrees or on-the-job training. This can be achieved through continued support of the public workforce development system, funding and awarding H-1B Skills Training Grants, and expansion of Registered Apprenticeship programs.

targeted investments will be made to help to establish domestic manufacturing, with additional incentives for companies to use advanced manufacturing practices.

*Near Term Next Steps:*

- HHS and the White House will host a high-level summit on drug supply chain resilience to kick off this new initiative.
- The Administration will assemble a consortium of public health experts (including emergency medicine and critical care) in the government, non-profit, and private sector to review the Essential Medicines list and recommend 50-100 drugs that are most critical to have available at all times for U.S. patients because of their clinical need and lack of therapeutic redundancy (Critical Drug List), and determine a potential volume that could be needed, using the surges during COVID-19 pandemic as one metric for that analysis.
- HHS will conduct an analysis of the Essential Medicines that went into shortage in the past year to determine major drivers, including mapping their supply chains to characterize their redundancy, diversity, and manufacturing quality.
- HHS will leverage the DPA process to determine the financial incentives needed to onshore or nearshore the production capacity needed for the global supply chain.

*Medium Term Next Steps:*

- HHS will use the 708 process to assemble a group of pharmaceutical supply chain experts to develop a resilience framework, based on the above analysis, that details the characteristics of a high quality, diverse, and redundant supply chain for pharmaceutical products.
- HHS will map the supply chains for the Critical Drug List to the resilience framework for a robust supply chain and identify those for which onshoring/nearshoring may be advisable.
- HHS will determine if there is a need to increase production or stockpile API for the Critical Drug List, and if so, identify the amounts needed in such a stockpile, the benefit and risk of a virtual stockpile, and the ability to utilize platform technologies to provide surge production in crises.
- Additionally, HHS will explore stockpiling strategies to reduce API supply risk, including an analysis of KSMS.
- The U.S. Government will review reimbursement models for key essential medicines to determine whether changes to reimbursement models could improve the resilience of key essential medicines without unduly impacting U.S. costs.

*Use Incentives to Create Redundancy for Sterile Injectable Production*

Logistical and transportation issues already create inherent incentives for the domestic production of sterile injectables which are critical to the care and treatment of American patients. However, sterile injectables are often at risk of shortage because of their low profit margins and the expensive specialized equipment, materials, and facilities necessary for their production. To increase the resilience of the sterile injectable supply chain, three actions should be pursued to reduce risk:

- *Financial incentives to spur investment.* The United States will continue using the Biomedical Advanced Research and Development Authority and other incentive-based tools to invest in specialized equipment and updates to mature quality manufacturing processes, including advanced manufacturing techniques, for these products. This will help reduce the barrier to entry for new manufacturers or reduce the cost to existing manufacturers looking to upgrade their facilities.
- *Update reimbursement models.* For lower cost drugs, profit margins from federal payers may play a role in ensuring that sterile injectables are at least risk of being in short supply. Accordingly, to reduce the

likelihood that these products will go into shortage due to low margins, the U.S. Government will review reimbursement models to determine updates that may improve supply chain resilience.

- *Procurement guarantees.* While incentives for establishing production and competitive reimbursement models are needed, manufacturers have indicated they also require consistent demand to justify investments for new production. Procurement guarantees, combined with leveraging acquisition flexibilities, can be used to signal commitment to and demand for products from domestic and small firms. These will need to be established in a careful and nuanced manner to ensure that they serve the needs of agencies, including DOD and the Department of Veterans Affairs (VA), and to ensure consistency with U.S. procurement laws and obligations.

#### *Near Term Next Steps:*

- HHS will convene a working group to analyze how reimbursement policies contribute to the lack of resilience for sterile injectables identified in the previous proposal as well as chemotherapeutics that have been in shortage in the past 5 years.
- HHS will evaluate whether certain sterile injectables that are identified as being at significant risk of shortage but are not part of the Critical Drug List medicines identified above, e.g. sterile pediatric oncology drugs, should also be the subject of enhanced supply chain resilience work in addition to drugs on the Critical Drug List.

## **2. Invest in Research and Development**

The second element of spurring domestic and resilient production and cooperating with partners is promoting R&D that develops innovative manufacturing processes and production technologies that will strengthen supply chain resilience. Significant commercial innovation has driven the development of novel platform technologies for the COVID-19 response, such as the development of new technologies that expand pharmaceutical production on-demand. Many of these are in late-phase development or ready for commercialization. Expedited interagency action to combine product demonstration and regulatory review can accelerate the delivery of new testing and platform technologies that reduce demand on legacy supply chains and more rapidly deliver public health services to patients in need. New production technologies can be used by both the United States and our allies and partners to promote collective supply chain resilience.

#### *Establish Novel Platform Production Technologies as Mainstream*

HHS, in partnership with DOD, has recently established on-demand manufacturing capabilities for supportive care fluids, API, and FDF drugs in modular, highly portable platforms. These platforms are revolutionizing the production of domestic pharmaceutical manufacturing through the use of novel synthetic chemistry processes that modernize flow chemistry, liquid-liquid extraction, and phase separation to produce any required API, and continue to demonstrate scale production of essential medicines, beyond those used for COVID-19 patients. These investments in capability will immediately yield cost competitive production of critical pharmaceuticals in support of the Strategic National Stockpile, as well as allow for expansion to produce additional essential pharmaceuticals in support of national healthcare priorities. HHS and DOD are currently demonstrating that medicines produced in this fashion can be purchased at one-tenth the cost of what is listed on the current VA federal supply schedule. In addition, as mentioned above, the JUMPSTART initiative with ASPR and DOD is scaling up pre-filled syringes for vaccines and other uses.

There are also additional opportunities to support development and commercialization of novel platform technologies through traditional development programs (Small Business Innovation Research/Small Business Technology Transfer/Accelerators) sponsored by DOD and HHS. In addition to this, DOD and HHS have received broad authorities under Title III of the DPA to commercialize these technologies. As such, funding opportunities towards commercialization are available through the DPA Title III Office and HHS.

HHS and the FDA will also continue to work collaboratively towards the realization of these capacities. Significant investments will be required to streamline regulatory reviews, in addition to the capital expenditures required for the initial commercial-scale production of these platforms.

*Near Term Next Steps:*

- Using funding from the American Rescue Plan, in June 2021, the Department of Commerce-sponsored National Institute for Innovation in Manufacturing Biopharmaceuticals (NIIMBL), which will launch a whole-of-industry effort to develop fully integrated and smaller footprint platforms that will reduce supply chain demands for raw materials, increase domestic biomanufacturing surge capacity, and more broadly improve technological capabilities that can lead to the biomanufacturing of APIs.
- HHS will create an internal task force with experts from FDA and ASPR to increase capacity for supporting development, evaluation, and, if possible, implementation of novel manufacturing technologies and processes. The task force will visit existing facilities and form partnerships with domestic manufacturers or universities to study advanced manufacturing technologies. It will develop a strategy for the Secretary on how to facilitate a wider adoption of novel methods for commercial production of pharmaceuticals and biologics.

### **3. Create Quality Transparency**

The third element of spurring domestic and resilient production and working in cooperation with partners and allies is to create robust and mature quality management to ensure consistent and reliable drug manufacturing and quality performance. In its current form, the pharmaceutical marketplace does not recognize or reward investment in mature quality management. FDA's analysis found that quality problems are responsible for at least 63 percent of the drugs that went into shortage between 2013 and 2017.<sup>79</sup>

*Create a Rating System to Incentivize Drug Manufacturers to Invest in Achieving Quality Management Maturity*

HHS and FDA propose to create a program with a rating system aimed at recognizing and rewarding manufacturers for mature quality systems that achieve sustainable compliance and focus on continuous improvement, business continuity plans, and early detection of supply chain issues. The proposed rating system will evaluate the robustness of a manufacturing facility's quality management and could be used to inform purchasers and GPOs about the state of, and commitment to, quality management at the facility making the drugs they are buying. Pharmaceutical companies could, at their discretion, disclose the rating of the facilities where their drugs are manufactured. GPOs and purchasers would be able to require disclosure of the rating in their contracts with manufacturers. This effort would introduce transparency into the market and may provide top-rated manufacturers and small U.S. firms with a competitive advantage, potentially enabling them to obtain sustainable prices as well as grow market share. While there may be the perception that this could create a two-tiered quality system, all approved FDA-regulated products are required to meet the same quality, safety, and efficacy standards. A quality management maturity rating system will also be useful to international regulatory partners who can rely on it, where applicable and consistent with their domestic regulations, to foster their supply chain security and resilience as well.

FDA should lead the development of a framework to measure and provide transparency regarding a facility's quality management maturity with engagement from industry, academia, and other stakeholders. The development and adoption of this rating would:

- Communicate the value of quality management maturity so it can be adopted by manufacturers and priced into contracts by purchasers;
- Promote the adoption of better tools to measure manufacturing performance to allow earlier detection of potential problems that could lead to shortage; and

---

<sup>79</sup> Drug Shortages: Root Causes and Potential Solutions, U.S. Food and Drug Administration, 2019, Updated 2020. Available at: <https://www.fda.gov/media/131130/download>. Accessed on 4/2/2021.

- Incentivize improvements to manufacturing infrastructure that enhance reliability of manufacturing and thus supply.

*Next steps:*

- Establishing a quality rating system for drug and API production is a long-term initiative that will have to be developed in collaboration with business partners and with stakeholders.
- As a next step, the FDA could begin consultations with stakeholders to develop a framework for rating quality management maturity.
- Over time, the FDA will consider whether to establish a new PPP with industry to develop and support utilization of such a rating system. PPPs have proven effective for other Federal programs, such as the Pharmacy Quality Alliance,<sup>80</sup> a PPP that develops quality measures for use of pharmaceuticals, some of which have been adopted under Medicare CMS.

#### **4. Improve Information and Data Collection**

A robust surveillance system that leverages information and data is a critical component of resilience in the supply chain. However, the analysis in this report has identified key information gaps that present a major challenge to FDA's ability to perform adequate monitoring. A robust ability to understand the flow of drug material from API intermediate to distribution of the finished product would greatly increase the ability to identify and mitigate potential supply disruptions before they occur, as well as inform timely action for any shortages that do occur. In the short term, the U.S. Government should encourage stakeholders to make greater use of commercial data sources to identify supply chain risks while establishing a robust surveillance system over the long term.

*Leverage Commercial Data to Improve Supply Chain Resilience*

Commercial data providers have begun to collect information on the drug and API supply chains. FDA and HHS should encourage stakeholders throughout the supply chain to increase their use of commercial data to identify and mitigate supply chain risks while the U.S. Government stands up a more comprehensive initiative to collect data and to improve surveillance and oversight of drug and API supply chains.

*Seek Additional Authority Through Which FDA Can Collect Additional Data and Take Action to Improve Surveillance, Oversight, and Resilience of the Supply Chain*

Over the longer term, the U.S. Government should establish a new initiative to collect additional supply chain data to improve surveillance, oversight, and supply chain resilience.

The following are several critical sources of new data necessary to support such surveillance work:

- Drug manufacturing volume information and reporting;
- Complete registration and listing requirements;
- Distribution data on prescription drugs and certain biological products;
- Requiring manufacturers to notify FDA of an increase in demand; and
- Requiring that the labeling of API and finished product labeling include original manufacturers.

Empowering the FDA to collect this information will in many cases require statutory changes as well as close consultation with industry and other stakeholders. But this information will enable the FDA to conduct a more comprehensive risk assessment of the U.S. pharmaceutical supply chain to support legislative and executive branch efforts to ensure its adequacy and resilience. For example, FDA could begin to identify how many products are both vulnerable to shortage and primarily manufactured overseas. In addition, FDA could identify manufacturers with large market shares whose supply chains, whether domestic or foreign,

---

<sup>80</sup> Pharmaceutical Quality Alliance, <https://pqa.memberclicks.net/our-story>. Accessed on 5/23/21.

appear to be vulnerable because, for example, a manufacturer might rely primarily on a small number of manufacturing sites or might have high historical volatility in quantity shipped to wholesaler distributors. FDA could share key information under confidentiality agreements with federal agencies that rely on these supply chains to allow them to create plans to mitigate that risk, including, where appropriate and if funding is available, through additional supply contracts. FDA could also expedite reviews and inspections of new applications or manufacturing sites for these products to bolster their supply chains.

API and finished product labeling that identifies original manufacturers is particularly important. Lack of supply chain transparency on the origins of APIs and finished products can cause serious vulnerabilities due to fraudulent products in the supply chain. Because supply chain stakeholders are not always able to identify the original manufacturer, they may not be able to address manufacturing, quality, security, or safety concerns that could lead to patient safety issues. Repackaged or relabeled APIs sometimes do not include information that adequately identifies the original manufacturer, which can create challenges in tracking affected medications if problems are identified with the API. Similarly, many labels for finished products only provide the distributor's information, rather than the original manufacturer.

FDA should be given legislative authority to require this information be included on labels. To mitigate unintended consequences, this should be considered in tandem with creation of a rating system for quality management system maturity.

#### *Next Steps:*

- HHS will convene industry and other non-governmental stakeholders to share insight on commercial data sources and to encourage stakeholders across the supply chain to increase their use of commercial data to improve supply chain resilience.
- HHS will develop and make recommendations to Congress seeking statutory authorization to increase FDA and HHS ability to collect information and to require that API and finish drug labels identify original manufacturers.

### **Build Emergency Capacity**

Even as we bolster domestic production, there will always be unforeseen events that will stress even the most resilient supply chains. In addition, onshoring and creating new supply chains with allies will be an investment that will take a number of years. The second pillar of our supply chain resilience strategy is to build emergency capacity to ensure that we do not have shortfalls of critical drugs during times of crisis.

#### **5. Explore the Creation/Expansion of a Virtual Strategic Stockpile of API Reserve and Other Critical Materials Managed by the Strategic National Stockpile, Including Finished Doses**

The United States should create a virtual stockpile of APIs and other critical materials necessary to produce the identified Essential Medicines, with prioritization of the Critical Drug List and reliance to the extent possible on domestic suppliers, especially small and small disadvantaged businesses. A virtual stockpile would involve contracts with API and drug suppliers to hold surplus together with support for surge manufacturing capacity, rather than keeping APIs and drugs physically stockpiled at a central location.

A virtual stockpile approach will help mitigate concern over waste. Drug products are more fragile than other commonly stockpiled materials, such as metal, and their relatively short time before expiry could lead to large quantities of discarded materials, which could stress the supply chain. Consequently, the virtual stockpile should include a mechanism to cycle materials back into the market based on the stability of the product and how long it can be safely stored. Additionally, care must be taken with respect to the procurement of products and materials so as not to induce a shortage or price spike.

The government stockpiling strategy should consider including surge manufacturing capacity to limit the need to stockpile FDFs. The stand-by capacity, such as an additional complete processing line or single piece of equipment for a rate-limiting unit operation, could be requested to become operational as a shortage emerges regardless of cause. Again, as with material stockpiling, such production lines and equipment would need to

be routinely operated and maintained according to a cycle that assures readiness on short notice. This approach might be prioritized for medications that are difficult to stockpile for long periods of time, such as sterile injectables. The consortium proposed in the first recommendation should consider how to best implement such excess capacity in a cost-effective manner.

As plans are implemented for the creation of a new virtual stockpile or an expansion of the existing stockpile, advance planning and communication needs to be in place to avoid creating or exacerbating a shortage, not only by increasing demand for the API or drug by the amount needed for the stockpile, but also by causing others to feel a need to create their own stockpile, thus further increasing demand stressors on the supply chain.

*Next Steps:*

- HHS will determine specific API and finished drugs that need to be stockpiled, and identify the amounts needed in such a stockpile, the benefit and risk of a virtual stockpile, and the ability to utilize on-demand manufacturing to provide surge production in crises.
  - As part of this analysis, HHS will explore stockpiling strategies to reduce API supply risk, including an analysis of KSMS.

### **Promote International Cooperation and Partner with Allies**

Domestic production is only one aspect of driving resilience in the pharmaceutical supply chain, since it is not feasible, desirable, or realistic to expect every drug needed for American patients to be produced on American soil. As such, and with the growing dominance of competitor nations, the United States must work with its like-minded regulatory partners to develop a secure and resilient supply chain that is not overly reliant on materials or manufacturing from countries that lack a shared interest in mutually beneficial supply chain arrangements. That is why the third and final pillar of our strategy is to increase international cooperation and partner with allies to strengthen supply chain resilience.

### **6. Ensure International Harmonization for Reviewing and Responding to Supply Chain Risk with Partnering Nations**

The U.S. Government should work through already established international regulatory collaboration and harmonization organizations, including but not limited to the International Coalition of Medicines Regulatory Authorities, the International Council for Harmonisation of Technical Requirements for Pharmaceuticals for Human Use, and the Pharmaceutical Inspection Cooperation Scheme to strengthen cooperation with allies and partners. The U.S. Government should also leverage other bilateral and multilateral fora and engagements to strengthen drug and API supply chain cooperation.

Specifically, the U.S. Government should use the criteria established in the first recommendation regarding the optimum geographic diversity and redundancy in a supply chain in collaborations with our major regulatory partners, who are already aligned on the need for more robust and stable supply chains and are beginning their own evaluations regarding the need for domestic manufacturing together with supply chains that are integrated with allies. Cooperation with allies should focus on understanding the risks to the global supply chain and collectively developing solutions that reduce identified risks. Additionally, as allies and partners look to onshore some production, the United States and partners should develop complementary strategies that create an appropriate amount of redundant production without unnecessary duplication across allied nations. This should also include the convergence of regulatory standards to allow for changes that promote manufacturing quality to be done expeditiously across all parties.

An example of a targeted action that the United States can take with allies and partners is the development of a centralized API supplier database. Manufacturers face difficulties in changing their API source (e.g., when they need to increase production or respond to a disruption from their API supplier). Although FDA lists API suppliers and recently inspected API manufacturing facilities, there is no complete, centralized source of



information on API suppliers, so firms often incur time and expense seeking such suppliers. Such a centralized database would enable manufacturers to easily identify alternative sources of APIs and more dynamically shift between suppliers in the event one experiences a disruption, decreasing the risk of a shortage.

*Next Steps:*

- For the Critical Drug List identified in the first recommendation, engage with international partners to map a global supply chain where redundancy and diversity includes sufficient onshoring, production in geographically accessible locations, and production by allies.

## ABBREVIATIONS

ANDA - Abbreviated New Drug Application  
API - Active pharmaceutical ingredient  
ASPR - Assistant Secretary for Preparedness and Response  
CARES Act - Coronavirus Aid, Relief, and Economic Security Act  
CATT - CBER Advanced Technologies Team  
CBER - Center for Biologics Research and Evaluation  
CDER - Center for Drug Evaluation and Research  
CGMP - Current Good Manufacturing Practice  
CM - Continuous manufacturing  
CMS - Centers for Medicare & Medicaid Services  
DOD - Department of Defense  
DOJ - Department of Justice  
DOL - Department of Labor  
DPA - Defense Production Act  
EC - European Commission  
E.O. - Executive Order  
ETA - Employment and Training Administration  
ETP - Emerging Technologies Program  
FDA - Food and Drug Administration  
FD&C Act - Federal Food, Drug, and Cosmetic Act  
FDF - Finished dosage form  
FEMA - Federal Emergency Management Agency  
GPO - Group purchasing organization  
HHS - U.S. Department of Health and Human Services  
KSM - Key starting material  
mRNA - Messenger RNA  
NIIMB L- National Institute for Innovation in Manufacturing Biopharmaceuticals  
PPP - public-private partnership  
R&D - Research and development  
SCCT - Supply Chain Control Tower  
SCRM - Supply Chain Risk Management  
VA - Department of Veterans Affairs