

**U.S. CLIVAR**

May 2010, Vol. 78 No. 1

# VARIATIONS

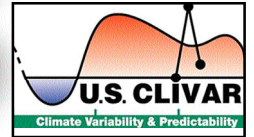

## The Impact of Field Campaigns

by David M. Legler, Director

**F**ield campaigns/process studies are a major suite of activities in CLIVAR. Over the past ten years CLIVAR has helped plan and

## Measuring and understanding surface heat fluxes in a changing Arctic environment

Jennifer E. Kay

National Center for Atmospheric Research (NCAR)

**E**arly climate models projected Arctic warming and sea ice loss in response to increased greenhouse gas forcing (Manabe and Stouffer, 1980). The Arctic climate change predicted by these early models and the current generation of climate models is occurring. Passive microwave satellite observations from 1979 to present show steady declines in Arctic sea ice extent in all seasons, especially in late summer (Figure 1). Observations from ships and satellite laser altimeters indicate that Arctic sea ice has been thinning (Kwok and Rothrock, 2009). That Arctic sea ice loss is occurring is not surprising, but the record-breaking loss in recent years has impressed both experts and the general public alike.

Some climate models can reproduce observed 20th century Arctic sea ice extent loss and simulate extreme events akin to the 2007 melt year (Holland et al., 2006). Yet, our understanding and modeling of Arctic climate processes remains far from perfect. Stroeve et al. (2007) found that many climate models under-predict the observed 20th century sea ice loss. The reasons behind the mean climate model under-prediction of observed sea ice loss are multi-faceted. Biases in sea ice thickness (Bitz et al., 2008) and longwave feedback strengths (Boe et al., 2009) may help explain the deficit in modeled Arctic sea ice loss. Beyond model biases, we must remember that

Arctic climate trajectories are inherently difficult to predict. Natural variability in large-scale Arctic circulation patterns is appreciable and contributes to observed Arctic climate change (e.g., early 20th century warming (Wood et al. 2009), 1979-2007 Arctic sea ice loss trends (Deser and Teng, 2008)). The magnitude of aerosol and greenhouse gas forcing affects Arctic climate trajectories and depends on human decisions. Even if we could perfectly model the Arctic climate system, we expect spread in Arctic climate projections.

Observed Arctic climate change and the March 2007-March 2009 International Polar Year have galvanized the scientific community to understand the processes that control Arctic climate in a warming world. Many important questions remain unanswered: How do natural variability and human-forced changes contribute to observed Arctic climate change? How will increasing greenhouse gas concentrations and aerosol burdens affect the trajectory of Arctic warming and sea ice loss? When will the Arctic be seasonally ice-free? How do the ocean and atmosphere interactions change in warming world? Observations of a changing Arctic system provide invaluable new information. For example, from the 2007 melt season, we learned that long-term trends and conditions during an individual melt season can combine to generate record-breaking ice loss.

*Continued on Page Two*

### IN THIS ISSUE

Surface heat fluxes in a changing Arctic environment .....	1
High Latitude Fluxes and Products .....	4
US CLIVAR High Latitude WG .....	7
Wind Products in Southern Ocean.....	8
Calendar .....	16

**U.S. CLIMATE VARIABILITY AND PREDICTABILITY (CLIVAR)**

1717 Pennsylvania Avenue, NW, Suite 250, Washington, DC 20006 • [www.usclivar.org](http://www.usclivar.org)

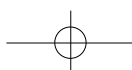

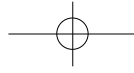

# U.S. CLIVAR

Continued from Page One

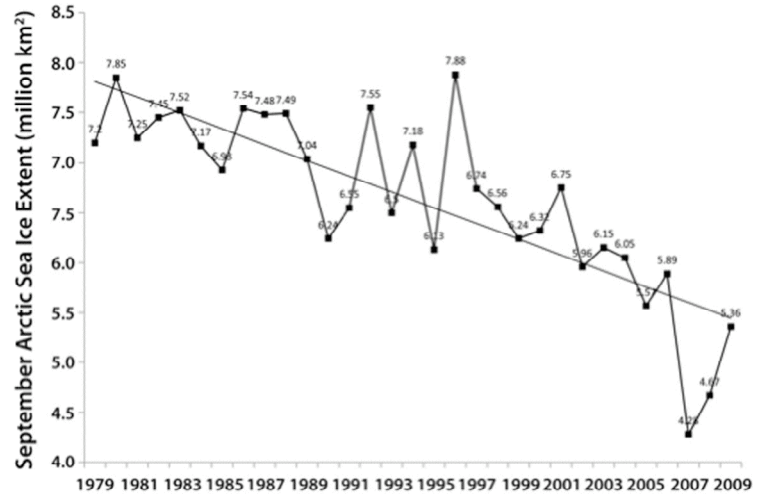

Figure 1. Observed September Arctic sea ice extent decline. Sea ice extent data from the National Snow and Ice Data Center: <http://sidads.colorado.edu/DATASETS/NOAA/G02135/>.

In this article, I will enumerate three issues pertinent to understanding Arctic surface heat fluxes in a changing Arctic environment. The material comes from an invited presentation I gave as a part of the CLIVAR Workshop "Surface Fluxes: Challenges for High Latitudes" held in March 2010. First, I will describe the status of Arctic heat flux observations. Second, I will share concerns regarding the current use of gridded surface heat flux datasets. Third, I will add my plea to existing pleas for increased Arctic surface heat flux observations, especially over the seasonally ice-free Arctic Ocean.

### Direct Arctic surface energy flux observations

What direct observations of surface heat fluxes are currently available in the Arctic? As discussed in (Bourassa et al., submitted), the answer is very few. The two primary sources are: 1) individual monitoring sites 2) individual field campaigns. At present, sustained monitoring of Arctic fluxes is only done at land-based sites: Barrow, Alaska (1992-present), Ny-Ålesund, Norway (1992-present), Alert, Canada (2004-present) (see Baseline Surface Radiation Network (<http://www.gewex.org/bsrn.html>)). These land-based sites provide continuous observations available to constrain year-to-year variability, to monitor surprise events, and to validate indirect sur-

face flux estimates. Individual field campaigns have been and will continue to be an important source of surface heat flux observations. Field campaigns require dedicated teams and an intense amount of preparation and planning. Data available from individual IPY field campaigns are impressive. As a part of the Swedish Arctic Summer Cloud Ocean Study (ASCOS, <http://www.ascos.se/>), researchers collected in situ flux measurements near 87N 15W from 1 August to 9 September, 2008. During the Canadian Flaw Lead System Study (CFL, <http://www.ipy-cfl.ca/>), surface flux observations were collected from October 2007 to August 2008. Never-the-less, it is disappointing that as far as I know, no in situ surface heat flux data were collected over the Arctic Ocean during the record-breaking 2007 sea ice melt season. No doubt the lack of observations in regions that are rapidly changing reflects the disconnect between planning and funding timescales for field experiments and the staggering rates of observed change.

Even though direct observations of Arctic surface fluxes are limited, the available data raise interesting and important scientific issues. The 2007 melt season is a prime example. Early sea ice extent loss and increased downwelling shortwave radiation led to strong shortwave feedbacks that enhanced ice

## Variations

Published three times per year  
U.S. CLIVAR Office  
1717 Pennsylvania Ave., NW  
Suite 250, Washington, DC 20006  
[usco@usclivar.org](mailto:usco@usclivar.org)

Staff: **Dr. David M. Legler**, Editor  
**Cathy Stephens**,  
Assistant Editor and Staff Writer  
© 2010 U.S. CLIVAR

Permission to use any scientific material (text and figures) published in this Newsletter should be obtained from the respective authors. Reference to newsletter materials should appear as follows: *AUTHORS*, year. Title, *U.S. CLIVAR Newsletter*, No. pp. (unpublished manuscript).

This newsletter is supported through contributions to the U.S. CLIVAR Office by NASA, NOAA—Climate Program Office, and NSF.

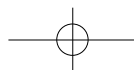

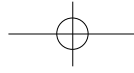

## VARIATIONS

loss (Figure 2). But given that high temporal resolution surface heat flux observations are only available at Barrow, addressing the extent to which enhanced shortwave feedbacks contributed to the 2007 sea ice loss is difficult.

What about turbulent heat fluxes? Atmosphere-ocean coupling via turbulent fluxes is enhanced when a warm open-ocean underlies a rapidly cooling atmosphere. This physical intuition suggests that large changes in turbulent fluxes have occurred in early fall over regions of newly open water. Indeed, the observed cloud and boundary layer response to early fall sea ice loss is indicative of large turbulent flux increases (Kay and Gettelman 2009). Addressing the magnitude of these turbulent flux changes is difficult given the paucity of observations.

### Using gridded surface flux products to address scientific questions about a changing Arctic environment

Gridded up-to-date surface energy flux products based on satellite observations or reanalysis models are used to directly address scientific questions or as forcing datasets for model experiments. Yet, gridded surface energy flux

products have a wide range of quality and reliability. To obtain surface radiative fluxes from satellite observations requires running a radiative transfer model (e.g., Rossow and Zhang, 1995). The quality of the surface fluxes produced by running the radiative transfer model depends primarily on the quality of the input atmospheric profiles of temperature, water vapor, and cloud properties. Surface fluxes in reanalysis products depend on the underlying atmospheric model, especially in data-sparse regions. Studies have long pointed to large discrepancies in Arctic energy fluxes in gridded flux products and direct observations (e.g., Serreze et al. (1998)). My comparisons of NCEP-NCAR reanalysis and ISCCP surface flux products with Barrow observations confirm little has changed. A summer cloud deficit in the NCEP-NCAR reanalysis leads to excessive surface downwelling shortwave radiation and too little surface downwelling longwave radiation. The summer downwelling flux differences between NCEP-NCAR and Barrow observations exceeded 60 Wm<sup>-2</sup>. The ISCCP surface fluxes were closer to Barrow-observed fluxes, but summer down-

welling flux differences still reached 20 Wm<sup>-2</sup>. Analysis of the CERES FlashFlux dataset has begun, but "oddities" with surface shortwave fluxes are still being resolved (personal communication, P. Stackhouse).

While the pitfalls of surface energy flux datasets are well documented, the misuse of these datasets is ubiquitous. Why is this happening? The temptation to use gridded datasets, even ones with clearly demonstrated problems, is too great. When up-to-date gridded data products are available and the Arctic is changing fast, there is pressure to generate quick explanations. Unfortunately, the credibility of these results is often not questioned.

How do we remedy this situation? There was a great deal of discussion on this topic at the March CLIVAR meeting. Everyone agreed that dataset producers should help their users discriminate between appropriate and inappropriate uses of their flux products. In practice though, I believe the burden falls mostly on reviewers of scientific papers. If papers that use surface flux datasets inappropriately are published, they set precedence and promote future misuse. When reviewing an analysis that depends on a gridded surface flux dataset, reviewers must ask a simple question: Do the pitfalls of the utilized gridded surface flux data product affect the scientific conclusions being drawn? If they do, the conclusions should be changed or the paper must be rejected.

To provide examples, I describe two pitfalls of surface flux products that have been on my mind. First, many surface flux products use climatological or highly idealized surface properties that are inappropriate for a changing Arctic environment. Whether the Arctic Ocean is ice-free or ice-covered has a huge influence on shortwave fluxes during summer and turbulent fluxes during fall and winter. Some reanalysis products assume constant surface albedo values over ice-covered surfaces through the melt season, which will also lead to erroneous surface shortwave fluxes. Second, many parameterizations use cloud fraction as the sole parameter

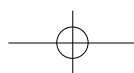
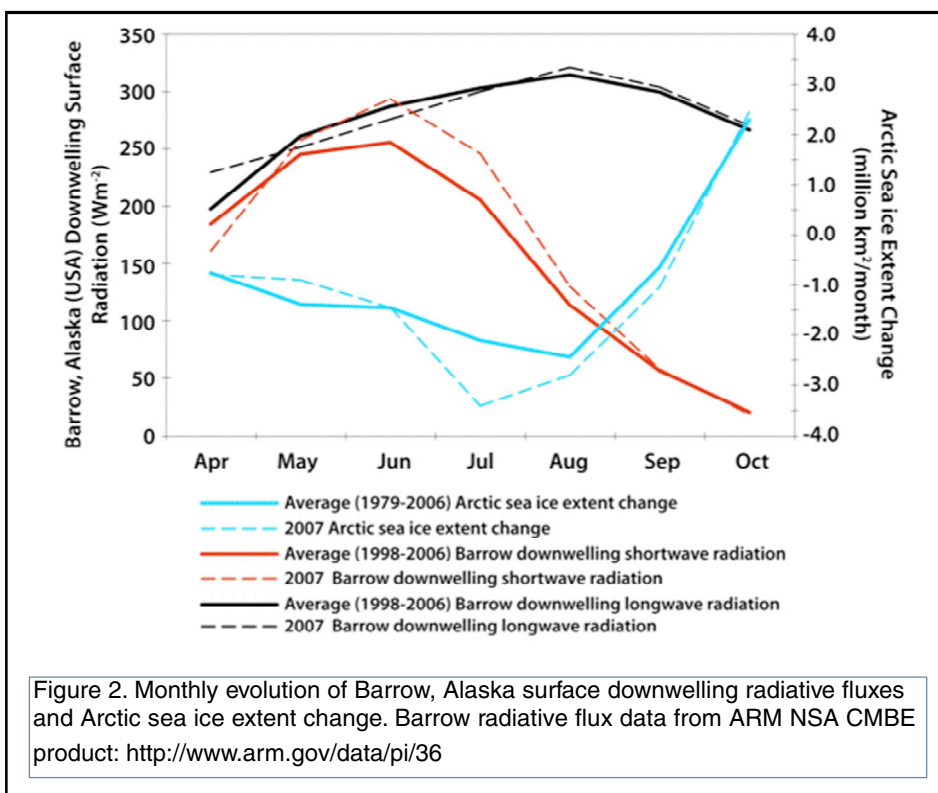



# U.S. CLIVAR

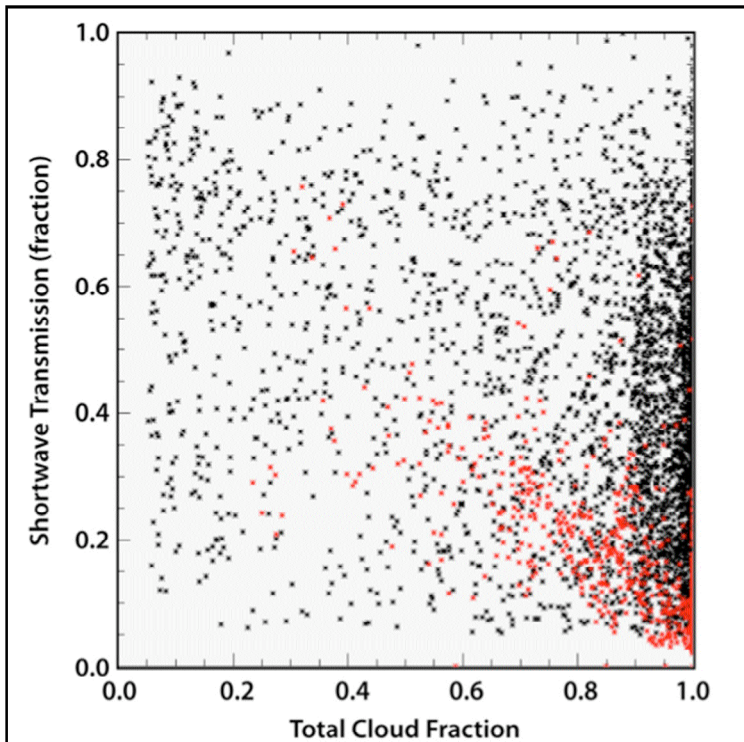

Figure 3. Scatter plot of total cloud fraction and shortwave transmission. Shortwave transmission is defined as the fraction of the top-of-atmosphere solar radiation reaching the surface. The data are hourly averaged July values at Barrow, Alaska taken from a global atmospheric model (black) and surface observations (red). Surface observations of total cloud fraction and surface downwelling shortwave radiation from ARM NSA CMBE product: <http://www.arm.gov/data/pi/36>. Atmospheric model total cloud fraction, surface downwelling shortwave radiation, and top-of-atmosphere solar radiation from CAM4 (<http://www.cesm.ucar.edu/models/ccsm4.0/cam/>).

to describe the influence of clouds on radiative fluxes (e.g., Parkinson and Washington (1979)). Figure 3 demonstrates the problem with using cloud fraction alone to predict surface shortwave fluxes. Observations and data from a global atmospheric model are both plotted. The observations show the expected relationship between cloud fraction and surface shortwave fluxes: shortwave transmission decreases with increasing cloud cover. For a given cloud fraction, the scatter in transmission is greater for small cloud fractions (~60%) than for large cloud fractions (~10%). The model data do not show the expected relationship between shortwave transmission and cloud fraction. For cloud fractions exceeding 80%, shortwave transmission ranges from 5 to 95%. This surprising result is explained

by the fact that the model contains many optically thin clouds that have little influence on surface shortwave fluxes. The take-home message is not surprising: Cloud fraction alone does not constrain surface radiative fluxes. Cloud properties also matter.

### Data requirements for the future

Sustained in situ observations and improved surface flux products are essential tools for understanding a changing Arctic environment and improving climate model projections.

The observation

and dataset use recommendations of groups such as US CLIVAR Working Group on High Latitude Surface Fluxes (Bourassa et al., submitted), and the AON Design and Implementation (ADI) task team

(<http://www.arcus.org/search/aon/adi/>) should be implemented. From my perspective, the most glaring observational gap is the lack of measurements over the newly ice-free Arctic Ocean.

### References

- Bitz, C.M., 2008: *Some aspects of uncertainty in predicting sea ice retreat, in Arctic Sea Ice Decline: observations, projections, mechanisms, and implications*, AGU Geophysical Monograph Series, edited by E. deWeaver, C. M. Bitz, and B. Tremblay, pp. 63-76.
- Boé, J., A. Hall, and X. Qu, 2009:

*Current GCMs' Unrealistic Negative Feedback in the Arctic*. *J. Clim.*, 22, 4682-4695.

Bourassa et al., *High-Latitude Ocean and Sea Ice Surface Fluxes: Requirements and Challenges for Climate Research*, submitted to BAMS.

Deser, C., and H. Teng, 2008: *Evolution of Arctic sea ice concentration trends and the role of atmospheric circulation forcing, 1979-2007*. *Geophys. Res. Lett.*, 35, L02504, doi:10.1029/2007GL032023.

Holland, M.M., C.M. Bitz, and B. Tremblay, 2006: *Future abrupt reductions in the Summer Arctic sea ice*, *Geophys. Res. Lett.*, 33, L23503, doi:10.1029/2006GL028024.

Kay, J. E. and A. Gettelman, 2009: *Cloud influence on and response to seasonal Arctic sea ice loss*, *J. Geophys. Res.*, 114, D18204, doi:10.1029/2009JD011773.

Kwok, R., and D. A. Rothrock (2009), *Decline in Arctic sea ice thickness from submarine and ICESat records: 1958 2008*, *Geophys. Res. Lett.*, 36, L15501, doi:10.1029/2009GL039035

Manabe, S., and R. J. Stouffer (1980), *Sensitivity of a Global Climate Model to an Increase of CO<sub>2</sub> Concentration in the Atmosphere*, *J. Geophys. Res.*, 85(C10), 5529-5554, doi:10.1029/JC085iC10p05529.

Parkinson, C.L. and W.M. Washington, 1979: *A large scale numerical model of sea ice*. *J. Geophys. Res.*, 84, 311-337, 1979

Rossow, W. B., and Y.-C. Zhang, 1995, *Calculation of surface and top of atmosphere radiative fluxes from physical quantities based on ISCCP data sets: 2. Validation and first results*. *J. Geophys. Res.* 100, 1167-1197.

Serreze, M.C., J. Box, and J. Key, 1998. *A new monthly climatology of global radiation for the Arctic and comparisons with NCEP/NCAR reanalysis and ISCCP-C2 fields*. *J. Climate*, 11(2), 121-136.

Stroeve, J., M. M. Holland, W. Meier, T. Scambos, and M. Serreze, 2007: *Arctic sea ice decline: Faster than forecast*, *Geophys. Res. Lett.*, 34, L09501, doi:10.1029/2007GL029703.

Wood, K. R., and J.E. Overland, 2009: *Early 20th century Arctic warming in retrospect*, *Int. J. of Climatol.*, doi: 10.1002/joc.1973.

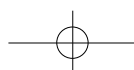



# VARIATIONS

## High Latitude Fluxes and Products:

### The case for gridded time series

*W.G. Large National Center for Atmospheric Research, Boulder CO*

This note summarizes the key points presented at the U.S. CLIVAR - SEAFLUX workshop on high latitude surface fluxes. The presentation made the science case for improving gridded time series of surface fluxes at high latitudes. These fluxes play a fundamental role in the behavior of the coupled climate system and they are essential to assessing flux errors in coupled climate model simulations, and hence the credibility of model results. Globally, knowledge of climate system can be advanced by conducting controlled numerical experiments with component models in isolation. Such experiments require specification of surface boundary conditions; for example at the ocean surface, at the bottom of the atmosphere, as well as above and below sea-ice. One important aspect of such experiments is to investigate coupled feedbacks and remote responses by cutting feedback loops (e.g. the positive ice-albedo feedback) and teleconnections. In addition, a fundamental challenge of climate change science is to estimate and understand large scale (global and decadal) trends in the fluxes between climate components. High latitude fluxes are not negligible in these trend estimates, because of the amplifi-

cation effect of changing sea-ice concentration.

Some fluxes are known to sufficient accuracy for most purposes. These include the open ocean wind stress, because of the success of satellite scatterometry, and the global average heat and freshwater flux, because observed changes of the ocean temperature salinity fields are small and imply that the averages are zero to within a few  $W/m^2$  and a few tenths of a  $mg/m^2/s$ , respectively. Ocean observations can also be used to estimate ocean heat and freshwater transports across basin wide sections, which under the assumption of no ocean storage anywhere, give implied surface fluxes averaged over areas between sections. The most well established section is across 26 N in the Atlantic, and most flux climatologies agree with the implied fluxes farther north. In some cases, but not all, the agreement is forced. The latter imply that the fluxes to the north of the section are accurately known, but unfortunately this is not really the case when the uncertainty in the implied fluxes is considered. A similar situation exists for the freshwater flux and for other ocean basins, including the Southern Ocean. It is also possible to infer surface fluxes

from estimates of heat and water transport divergences in the atmosphere, but again the uncertainties are not small. Therefore, there is a need for direct surface flux estimates, especially of the heat and freshwater.

High latitudes are particularly challenging because of the possible presence of sea-ice floating on the ocean, and snow cover over land and sea-ice. Even the simple case of sea-ice only is complicated. As illustrated in Fig. 1, gridded air-sea fluxes,  $FLUX_{as}$ , which themselves are difficult enough to determine, are only a part of the story. In order to have a Bottom of Atmosphere (BOA) flux,  $FLUX_{atm}$ , that the atmosphere really feels, the flux across the air-ice interface,  $FLUX_{ai}$ , is also required. The greatest challenge is the ocean-ice exchanges,  $FLUX_{oi}$ , because the ocean-ice interface is not easy accessible, and includes both the sea-ice base, and a lateral connection with open leads within a sea-ice field. Furthermore,  $FLUX_{oi}$  includes both the heat and freshwater fluxes associated with sea-ice formation and melt. Exchanges with the ocean are a combination of  $FLUX_{as}$  and  $FLUX_{oi}$ , and sea-ice formed in the ocean is passed to the ice, keeps the ocean from falling below the freezing point, and takes some of the ocean salt with it.

There are further complications at high latitudes. Continental runoff, is both surface (rivers) and sub-surface, and a component of the ocean freshwater budget everywhere, but at high latitudes some of the surface runoff can be in the form of ice with an associated latent heat of fusion. Furthermore, it is important to discriminate between rain and snow, because the latter has a negative latent heat of fusion content and very high albedo. However, satellite sensors do not respond to snow as they do rain and there is a troublesome divergence between various satellite

**Fig. 1: Challenges of sea -ice (snow) cover**

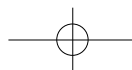
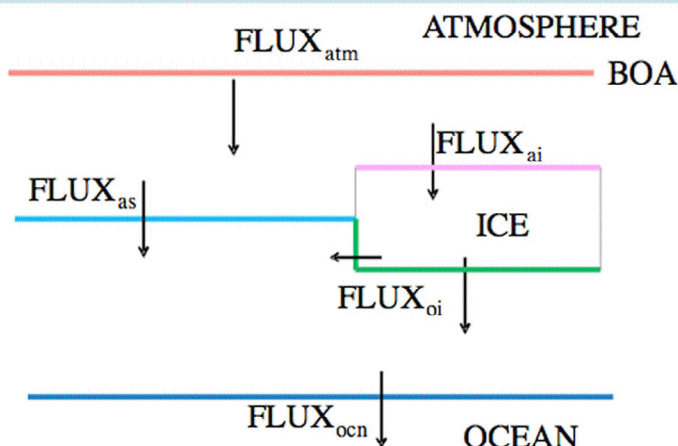



## U.S. CLIVAR

based precipitation products at high latitudes (Large and Yeager, 2008). Some products based on spectral atmospheric models display spurious precipitation bands around Greenland and the Antarctic Peninsula. When these are taken as snow on sea-ice, the higher albedos produce bands of thick sea-ice. Perhaps the best way of evaluating Southern ocean heat and freshwater fluxes is to compare the intermediate water mass characteristics of model solutions, but model error can also be a factor, so this technique is far less satisfactory than having independent knowledge of the fluxes and their uncertainties.

In regions of large interannual variability, a long time series of fluxes is required to establish a robust mean and quantify the variability, and relate it to local and remote climate signals. A particularly strong high latitude variability is that of the zonal winds around Antarctica. The strength of these westerlies is highly correlated with the Antarctic Oscillation (AAO). In the Pacific sector a plus (minus) one standard deviation in the AAO Index increases (decreases) the average zonal wind stress by more than  $0.03 \text{ Nt/m}^2$ , or 20% of the climatological mean. Thus use of gridded wind stress of any purpose in the Southern Ocean, must account for this variability. The North Atlantic Oscillation (NAO) describes much of the high latitude variability of the North Atlantic region. A plus (minus) one standard deviation of the NAO index can reduce (increase) the heat flux in the Labrador Sea by more than  $50 \text{ W/m}^2$ .

Knowledge of fluxes over the Labrador Sea is particularly important to understanding this region and its role in global climate, as illustrated in the following example from Chanut et al. (2006). The Labrador Sea (Fig. 2) is one of the few regions of oceanic Deep Convection (DC), where the ocean takes near surface properties to great depth and out of contact with the atmosphere. To first order this process is a response to intense surface cooling during late winter storms, so the NAO state is

Page 6

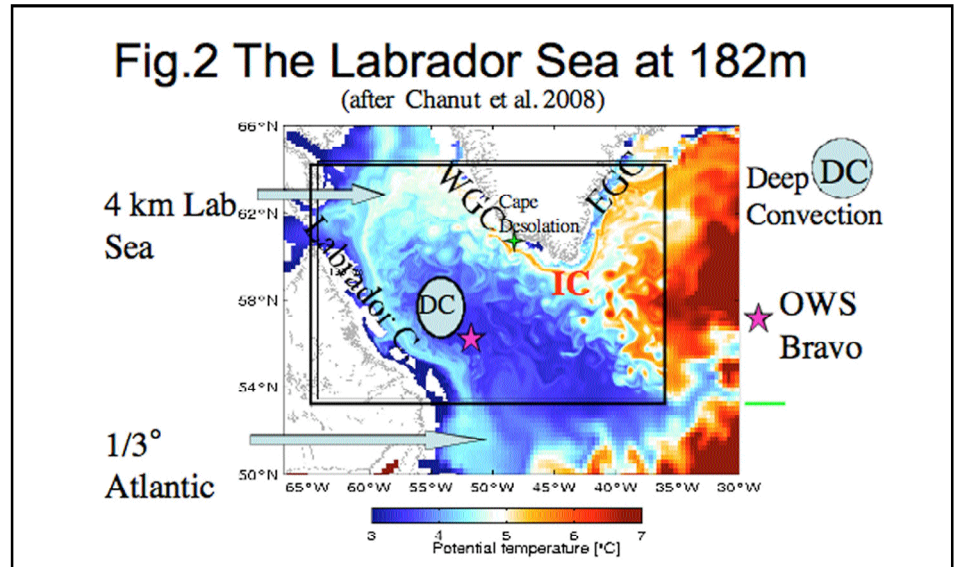

expected to contribute to its variability. However, there are other processes at work here, and time series of gridded fluxes have been used to drive models of this system. For example, Fig. 2 shows a 4km resolution model of the Labrador Sea nested with a  $1/3$  degree North Atlantic. The higher resolution is needed to resolve the ocean eddy field, which also has a first order effect on the regional heat budget, as does the boundary current structure. Briefly the surface cooling ( $-57 \text{ W/m}^2$ ) is balanced by the difference ( $53 \text{ W/m}^2$ ) between the heat inflow of the warm Irminger Current (IC) and the outflow of the cold Labrador Current. But it is eddy field that transports heat from these coastal currents ( $96 \text{ W/m}^2$ ) to the interior where it is lost mostly through the surface ( $76 \text{ W/m}^2$ ). On the smaller scale of the West Greenland Current (WGC) region the mean advection by currents ( $488 \text{ W/m}^2$ ) is not quite balanced by eddy transport ( $-412 \text{ W/m}^2$ ), with the difference made up by  $-78 \text{ W/m}^2$  of surface heat flux. Only over a small region, labeled DC, is the eddy transport insufficient, so that the heat is lost to the deep through deep convection. Since models are forced to conserve heat budgets must balance, so the credibility of these model results quantifying eddy heat fluxes in the Labrador Sea, depends on the credibility of the surface heat fluxes.

The hypothesis behind a series of Coordinated Ocean Research Experiments (CORE) was that with simi-

lar atmospheric forcing, different coupled ocean-sea ice models would give similar solutions (Griffies et al., 2009). The hypothesis was falsified and one of the main contributors was found to be the high latitude freshwater fluxes. With these fluxes posed as physical boundary conditions, none of the models were able to maintain a robust Atlantic Meridional Overturning Circulation (AMOC). In each model the problem was overcome by the addition of unphysical restoring to observed sea surface salinity, but the implementation differed greatly among the models. This is clearly an unsatisfactory solution, but the uncertainty of high latitude North Atlantic freshwater fluxes has severely hampered attempts to improve the situation.

### References

- Chanut, J., B. Barnier, W. G. Large, L. Debreu, T. Penduff and, J. M. Molines, 2008: *Mesoscale eddies in the Labrador Sea and their contribution to convection and re-stratification*. *J. Phys. Oceanogr.*, doi:10.1175/2008JPO3485.1
- Griffies, S.M. and co-authors, 2009: *Coordinated Ocean-ice Reference Experiments (COREs)*. *Ocean Modelling*, doi:10.1016/j.oce-mod.2008.08.007.
- Large, W.G. and S.G. Yeager, 2008: *The Global Climatology of an Interannually Varying Air-Sea Flux Data Set*. *Climate Dynamics*, 10.1007/s00382-008-0441-3





# VARIATIONS

## Surface Fluxes: Challenges for High Latitudes

Mark A. Bourassa<sup>1,2</sup>, Sarah T. Gille<sup>3</sup>, and Carol Anne Clayson<sup>1</sup>

<sup>1</sup>Department of Earth, Ocean, and Atmospheric Sciences, Florida State University, Tallahassee, Florida

<sup>2</sup>Center for Ocean-Atmospheric Prediction Studies, Florida State University, Tallahassee, Florida

<sup>3</sup>Scripps Institution of Oceanography and Department of Mechanical and Aerospace Engineering, University of California San Diego, La Jolla, California

Surface fluxes, and especially surface fluxes in high-latitude regions, were the focus of a March 17-19, 2010, workshop in Boulder, Colorado. Approximately 70 oceanographers, meteorologists, engineers, and others from a wide range of universities and national agencies, including representation from the European Union and Japan, met to discuss ocean-atmosphere and ocean-atmosphere-ice fluxes of momentum, energy, moisture, and CO<sub>2</sub>. Topics included in situ and satellite observations, parameterization of fluxes, variability of fluxes as represented by observations and numerical models, quality assessments of flux products, and broader impacts on the tropical and high latitude processes (atmospheric, oceanographic, and ice).

### Topics of Discussion

The meeting began with a review of challenges. Vast differences in flux products were described, as well as attempts to determine net fluxes on the basis of changes in ocean state and ice. Polar regions are relatively hostile for in situ observations, with very cold temperatures, high winds, and sea spray and riming that can cover instruments with ice. Approaches for dealing with some of these problems were developed during SHEBA (Uttal et al, 2002) and subsequent oceanic field campaigns; however, high latitudes remain a very difficult environment for in situ observations. Satellite observations are also quite challenging. The high wind speeds associated with orographic forcing and intense storms are not well calibrated; estimates of air temperature and humidity are poor over very cold water; and radiative fluxes are difficult to determine for a wide range of problems (xxref to Rossow's paper in this issue). Three processes that could be responsible for the change in Arctic ice mass and location were discussed: changes in radiative forcing (due to changes in the atmospheric column (Kay et al. 2010), changes in the local sea temperature associated with changes in the fraction of open ocean (Vancoppenolle et al., 2010), and changes in the wind forcing for wind-driven transport of ice. The relative importance of these processes remains to be determined; however, all these processes could be tied to changes in the Arctic atmospheric circulation.

Budgets and trends in high-latitude and tropical oceans were discussed. The uncertainty in budgets is diminishing; however, it is still far too large for studies of long-term climate change. Part of the difficulty in accessing such change is that natural variability is very large compared to trends. Another difficulty is large uncertainty due to insufficient sampling (Gulev et al. 2007a,b). The feedbacks in numerical weather prediction based reanalyses were examined, and the energy budget was found to be very sensitive to low cloud cover, which is not well modeled. Nevertheless, numerical models do represent key processes, and results from models can be used to determine processes that need further investigation and validation.

There was a great deal of discussion on gas fluxes at high latitudes. The cold high-latitude oceans are usually a large sink for CO<sub>2</sub>; however, in areas of strong upwelling CO<sub>2</sub> can be outgassed. The physical concepts behind parameterization of gas fluxes were discussed. Historically, these fluxes have been estimated in terms of monthly average winds; however, observational campaigns allow studies of the dependence of gas fluxes on local (hourly) winds and wave characteristics. These studies, combined with satellite observations surface stress might lead to better estimates of ocean uptake of CO<sub>2</sub>.

### Meeting recommendations

Remarkable progress has been made in both in situ and satellite estimations of surface fluxes. High-quality in situ observations are needed for a wide range of process studies, particularly for sub-surface processes, and for calibration of satellite observations. Public dissemination of high-latitude meteorological data is important. Development of a flux monitoring capability on vessels that operate routinely at high latitudes (e.g. the Antarctic support vessel L. M. Gould, which regularly traverses Drake Passage) was recommended as a high priority, as well as the processing and quality assurance of existing observations from such vessels. Well calibrated satellite observations will greatly improve the spatial sampling over the oceans, and will improve the temporal sampling in most areas.

There were several suggestions for future programs. An Antarctic version of SHEBA was strongly endorsed.

(continued on page 14)

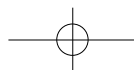

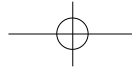

# U.S. CLIVAR

## Comparison of Wind Products in the Southern Ocean

Chin-Ying Chien<sup>1</sup>, Kevin Speer<sup>1</sup>, and Mark Bourassa<sup>1,2</sup>

<sup>1</sup>Department of Earth, Ocean, Atmospheric Science, Florida State University, Tallahassee, FL, USA

<sup>2</sup>Center for Ocean-Atmosphere Prediction Studies, Florida State University

In the Southern Ocean (SO), westerly winds generate northward Ekman transport which promotes oceanic exchanges from high latitudes to low latitudes. Closer to the Antarctic (AA) continent, the wind changes to easterly. This creates an area of strong oceanic divergence which brings denser and nutrient-rich deep water to surface. Also, storm motions may intensify localized Ekman upwelling and enhance the vertical exchanges of air-sea fluxes, nutrients and dissolved gas. Stronger storms might also induce the relatively warmer deeper water to the upper ocean and exacerbate sea-ice and iceberg melting. Wind stress and storm trends under climate change can therefore affect and possibly accelerate global ocean freshening. Accurate wind and wind stress data are required to investigate the wind field and its variability in the SO including the sea-ice zone. In addition, estimates of wind stress curl, Ekman upwelling and related computations are of interest for the upper ocean heat and salinity budgets.

Due mainly to the difficulties of remote sensing measurements in the large seasonal sea-ice area of the Southern Ocean, in the region between the Polar Front and the continent, there are fewer reliable observations of wind stress in this region. The purpose of this research is to focus on a comparison of wind products in the SO, and to attempt to evaluate these products across the region, including the sea-ice zone.

This study employs five wind products: (1) Quik Scatterometer, (hereafter QSCAT), (2) pseudo-stresses from the Center for Ocean-Atmospheric Prediction studies (denoted COAPS, at Florida State University (FSU)), (3) reanalysis winds from the National Center for Environmental Prediction (NCEP)-Department of Energy (DOE)

Atmospheric Model Intercomparison Project 2 reanalysis (hereafter NCEP2), (4) the Japanese Meteorology Center 25-year Reanalysis (hereafter JRA25) and (5) ERA-Interim reanalysis from the European Centre for Medium-Range Weather Forecasts (ECMWF). The grid spacing of these five products are (1) QSCAT: 0.25°x0.25° within the observational swath, twice per day; (2) COAPS: 1°x1°, 6-hour; (3) NCEP2: 1.875°x1.9°, 6-hour; (4) JRA25:

1.125°x1.125°, 6-hour and (5) ERA-Int: 1.5°x1.5°, 3-hour. The geographic region of this study comprises 40°S~70°S in latitude and 0°~360° in longitude. In the following we compare the wind speed, wind stress, wind stress curl, Ekman pumping and Eddy Kinetic Energy (EKE) of these products over the Southern Ocean.

### 1) Comparison of Wind Speed

Here, we define a bias as the differ-

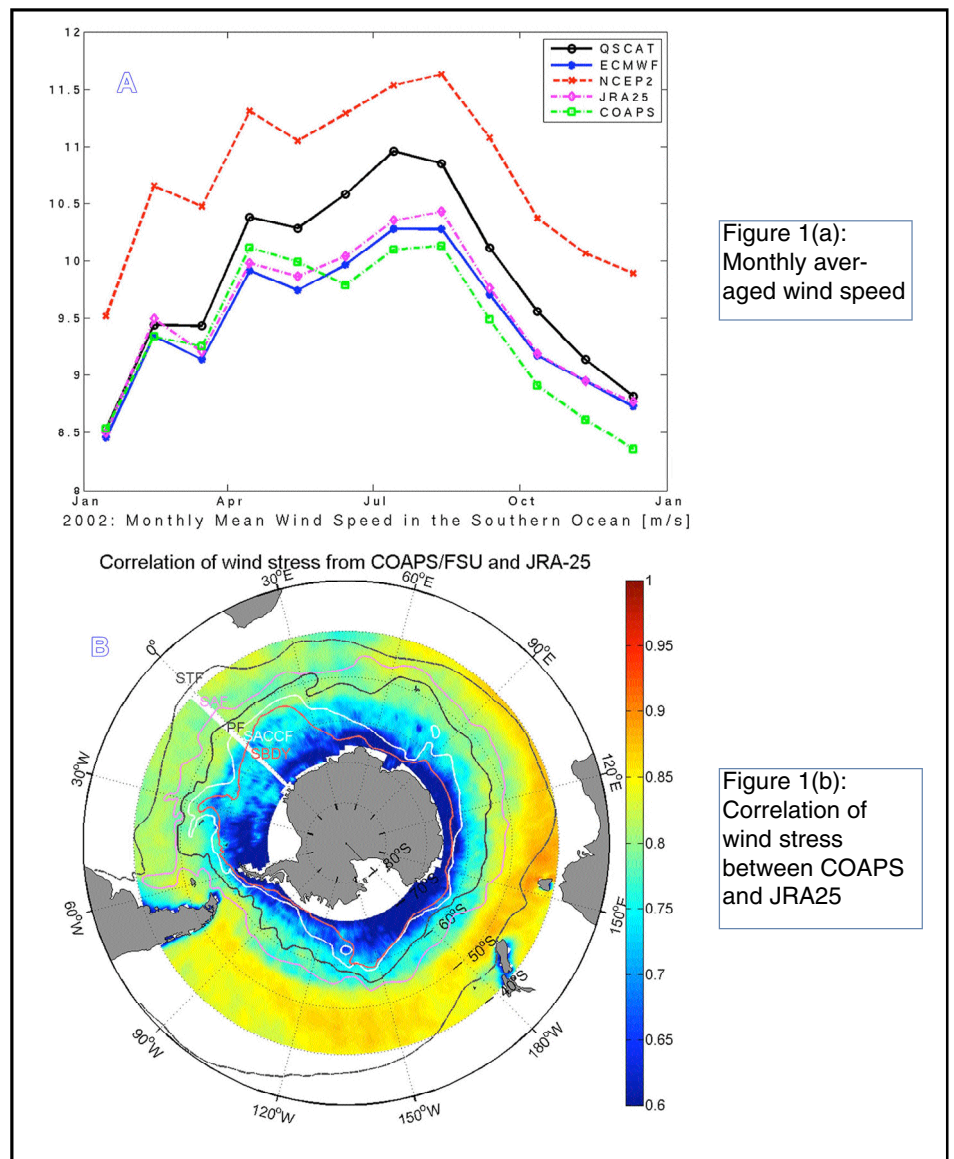
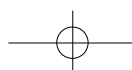
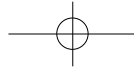

Figure 1(a): Monthly averaged wind speed

Figure 1(b): Correlation of wind stress between COAPS and JRA25







# VARIATIONS

ence between a given product and QSCAT. From the results of the comparison, NCEP2 wind speed shows larger bias than other wind speed products (Figure 1a). The yearly averaged bias of wind speed between NCEP2 and QSCAT is 0.88m/s. JRA25-QSCAT yearly bias is about 0.28m/s and 0.09m/s during summer. In the summer months, the two reanalyses show a better agreement of wind speed with QSCAT. The reason is thought to be because there are more data in the summer months and less intense low pressure systems. Overall, NCEP2 seems to represent wind speed in the SO less well than the other products.

From the comparison, QSCAT has stronger wind speed than most other products, especially during fall and winter. The differences of wind speed between QSCAT and other products are notable, especially in the winter months. From the comparison of seasonal wind speed variation, it indicates a large bias in the winter in comparison to satellite measurements. Presumably, this is due to the lower resolution of the models and difficulty representing the finer details of storms. The resolution of QSCAT is about 25km, which is much better than the resolution of the reanalyses winds and the resolution of the COAPS objective winds.

## 2) Comparison of Wind Stress

As latitude increases, there are large differences of wind stress between COAPS and the two reanalyses (JRA25 and NCEP2) especially in the 60°S~70°S. The correlation of wind stress from COAPS and JRA25 shows less similarity in the south of 55°S (figure 1b). A major reason is again likely to be related to the resolution. Errors occur, especially when forecasting or mapping cyclone motions. These errors are due to rapid changes in cyclone surface winds (these systems can translate and evolve very quickly), and differences in spatial and temporal smoothing scales in the gridded products. The yearly average Ekman pumping shows that 55°S appears roughly to be a divide between upwelling and downwelling (figure 2). North of 55°S both products

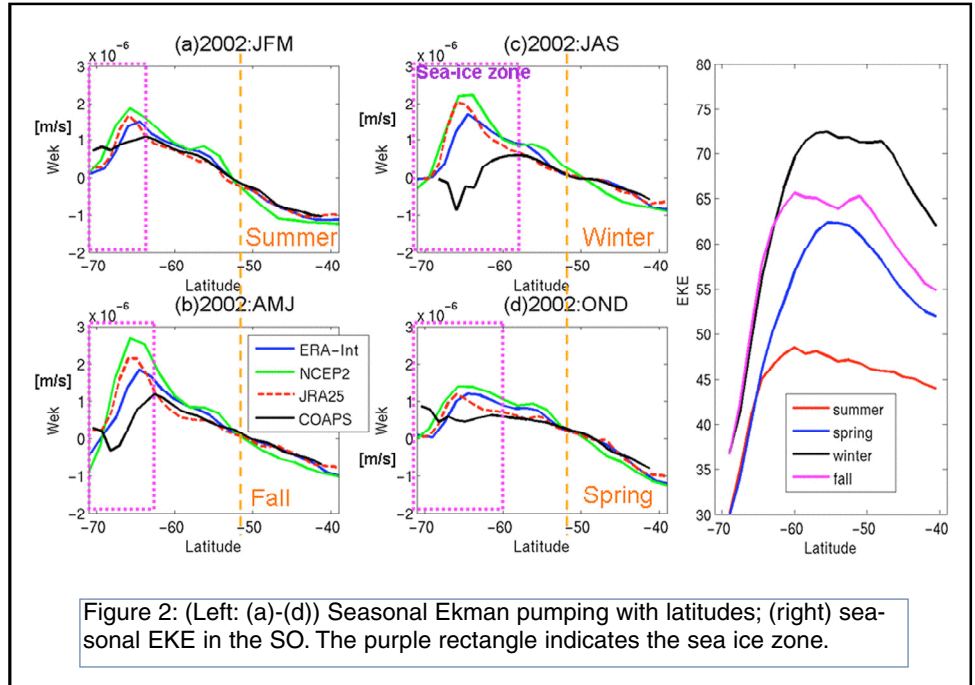

Figure 2: (Left: (a)-(d)) Seasonal Ekman pumping with latitudes; (right) seasonal EKE in the SO. The purple rectangle indicates the sea ice zone.

agree fairly well. South of 55°S, JRA25 shows general upwelling across the whole area, except near the coast, while COAPS shows more downwelling in this area.

The correlation in January is better than that in July. In January, COAPS wind stress is much stronger than JRA25 (about 1.0-1.3 times) except close to continents. However, in July, COAPS wind stress is weaker than JRA25, especially south of 55°S. Closer to the sea-ice edge, there is a larger difference between COAPS and JRA25. It is likely that sea-ice contamination influences the scatterometer observations: locations sometimes do not have wind observations. Therefore, the spatial/temporal averaging of the COAPS product covers a different domain. The observational database in the SO is much sparser than for other regions of the global reanalyses, for instance the tropical regions. The combination of resolution and raw meteorological observational density likely produces the observed difference between the reanalysis products.

## 3) Comparison of Wind Speed with Ship Data

We also use ship data to validate wind speed. Without correcting ship wind speed to 10-meter height, ship

wind is typically stronger because the ship observations occur above the 10m height to which satellite winds are calibrated. In the comparison we use both corrected and uncorrected values. In an example from one ship, 46 observations during January 2002 are available for the validation. From statistical analysis by standard deviation, correlation, variance and RMS, ERA-Int shows better relation with QSCAT and ship data. We conclude that wind speed from ERA-Int fits scatterometer winds and ship winds best in the SO. In addition, COAPS wind shows smaller RMS, standard deviation with ship data and QSCAT wind. This is not surprising since COAPS used the scatterometer winds; however, the slope of regression for COAPS (0.73) is slightly small compared to ship and QSCAT wind speed. JRA25 also presents similar results to COAPS. The variance of JRA25 (60%) is lower than ERA-Int (83%), but much higher than NCEP2 (48%). ERA-Int has similar data sources and quality control as JRA25 of data drawing on experience from ERA-40 and JRA25. Thus, ERA-Int and JRA25 ought to show similar responses in the SO.

Since QSCAT wind under 20m/s is of very good quality, we apply the statistical analysis to wind speed pairs



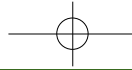

# U.S. CLIVAR

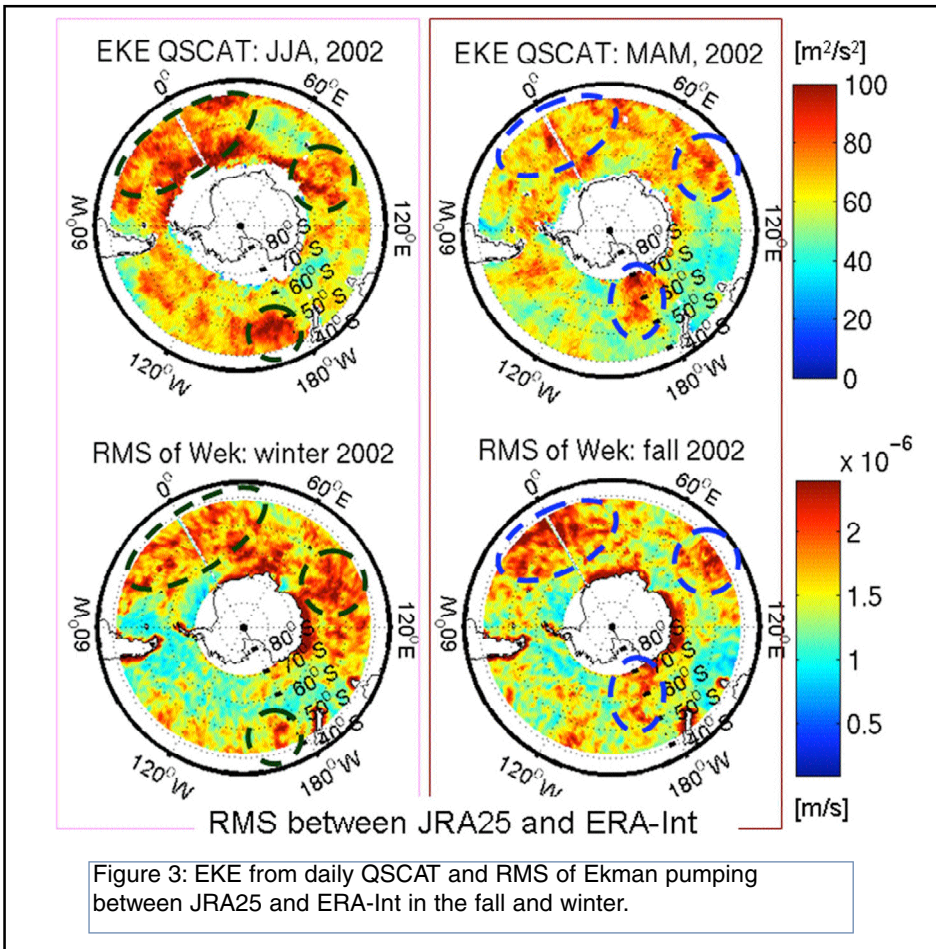

Ocean it is around 70°E~100°E, 45°S~60°S in the winter and around 90°E, 40°S~50°S in the fall. The location of stronger seasonal EKE is also consistent with the area of large RMS differences on the Ekman pumping between JRA25 and ERA-Int, especially in the South Atlantic Ocean and South Indian Ocean (figure 3). This implies that the major difference in EKE and the RMS of Ekman pumping is due to the representation of storms in the SO. The approximate RMS difference of Ekman pumping is of order . For cyclone-induced upwelling, this difference can result in substantial biases due to biases in reanalysis storm activities.

### (6) Conclusion

Study of the role of wind forcing and climate change induced responses on the ocean requires an accurate wind product that includes higher resolution in time and space, reasonable statistics, and data assimilation is important. All the products we have examined have difficulties in the seasonal sea zone of the Southern Ocean, reflecting choices made in analysis or reanalysis, as well as the amount of data available to constrain models, and the fundamental treatment of the boundary layer over this region. Yet a very large part of the Southern Ocean is covered by seasonal sea-ice and neglecting the quality of basic meteorological parameters in this region will lead to unrealistic variability in the surface fluxes and water masses of the Southern Ocean, hence an unrealistic attribution of key mechanisms of variability. Ultimately, a dedicated reanalysis of meteorological observations over the Southern Ocean and Antarctic continent in needed the produce a reference forcing of very high quality, against which other climate data sets and model simulations may be compared.

under 20m/s between QSCAT and other products and, then, conclude that the ERA-Int can explain the most variance of QSCAT. The wind speed pairs and wind stress analysis indicates a remarkable differences between reanalysis products. This must be caused by the different assimilation methods and various parameters chosen in the models.

### (4) Comparison of Wind Curl and Ekman Pumping

The seasonal wind curl versus latitude shows larger bias in the divergent region (55°S~68°S) in four seasons over the SO consistent with the wind stress comparison between COAPS and reanalysis datasets which also shows larger variation in the south of 55°S. There is a good agreement in the convergence zone (40°S ~52°S.) Seasonal bias increases for upwelling conditions especially in the sea-ice zone (Figure 2.) Between the regions of 55°S~68°S, there is stronger upwelling and larger difference between products, especially

during winter and fall. Moreover, each product shows the zonally averaged maximum upwelling at a somewhat different latitude. For example, there is about 1.43° different in latitude between JRA25 and ERA-Int. In addition, while JRA25 and COAPS have similar annual RMS in the SO, the three reanalysis wind curl (ERA-Int, JRA25 and NCEP2) all have large differences near the coast.

### (5) Seasonal EKE and Storm Activities

To compute seasonal EKE and quantify storm activities, 6-hourly or better scale wind data is required from ERA-Int. Using daily QSCAT EKE and 6-hourly ERA-Int data, most storm activities happen in the winter and fall. In the South Pacific Ocean, the maximum activity is near 180°W, 60°S~70°S in the fall and 170°W, 40°S~60°S in the winter. The maximum activity in the South Atlantic Ocean is around 30°W~30°E, 40°S~60°S, and for the South Indian

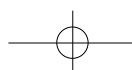



# VARIATIONS

## In situ air-sea flux observations during the International Polar Year

*Ian A. Renfrew*

*School of Environmental Sciences, University of East Anglia, UK*

The fourth International Polar Year (IPY) – co-sponsored by the International Council for Science (ICSU) and the World Meteorological Organisation (WMO) – ran from March 2007 to March 2009, involved over 50,000 scientists and thousands of projects. An International Project Office and comprehensive website ([www.ipy.org](http://www.ipy.org)), which includes project databases and access to data portals, has meant a high degree of international co-operation and co-ordination amongst scientists. During the two years of IPY-sponsored field campaigns a huge amount of additional observations of the polar regions were made: scientific discoveries are happening all the time and considerable effort is underway to make sure all IPY-sponsored data is properly archived. At this point in time, the first tranche of scientific papers are coming out in journals, but it is anticipated that this is just the first wave and the establishment of IPY archives will allow many years of further study, including synthesis work, meta-analyses and inter-disciplinary studies.

The purpose of this short article is to highlight some of the IPY-sponsored projects that have as a focus air-sea-ice interactions. In compiling such a summary, I have done my best to mention all relevant projects, but it is possible that some relevant projects have been inadvertently missed out, for which I apologise in advance. A few published articles are mentioned, but the majority of studies are still in preparation, so interested readers are encouraged to look at project websites.

### Aircraft-based experiments

The Greenland Flow Distortion Experiment (GFDex; see Renfrew et al. 2008 for an overview) took place in February and March 2007. Aircraft missions in the vicinity of Iceland and SE

Greenland were aimed at mapping out the structure of mesoscale features such as tip jets, barrier flows and lee cyclones caused by the interplay between the synoptic-scale atmospheric circulation and the high orography of Greenland. A compilation of six flights with significant low-level (~40 m) components were used to determine surface momentum, heat and moisture fluxes, by eddy correlation, during high wind-speed, cold-air outbreak conditions (Fig. 1; see Petersen and Renfrew 2009). These observations were also used to assess the quality of several meteorological analyses and reanalyses products under such conditions (see Renfrew et al. 2009). Further information can be found on the GFDex website ([lgmacweb.env.uea.ac.uk/e046/research/gfdex/index.htm](http://lgmacweb.env.uea.ac.uk/e046/research/gfdex/index.htm)).

For the last few years the British Antarctic Survey have been using their recently-instrumented twin otter to carry out numerous low-level missions over sea-ice, polynyas and open water on

both sides of the Antarctic Peninsula (see [www.camracers.org.uk/masin/](http://www.camracers.org.uk/masin/)). One boundary-layer study over a polynya in the southern Weddell Sea measured air-sea fluxes (Fiedler et al. 2010).

### Ship-based experiments

The Arctic Summer Cloud Ocean Study (ASCOS) is focused on the physical and chemical processes controlling low-level cloud formation and properties in the high Arctic. Taking place in the summer of 2008, it encompassed a comprehensively instrumented micrometeorological camp, with 3, 15 and 30 metre masts in two locations on a sea-ice floe at ~87N (Fig. 2). Comprehensive turbulence measurements have allowed air-sea-ice fluxes to be determined during primarily near-neutral and stable atmospheric conditions. The micrometeorological observations are complemented by radiosondes, a tethered system, cloud radar, aerosol instruments, doppler sodar and near-surface ocean profiling. There was

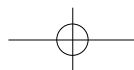
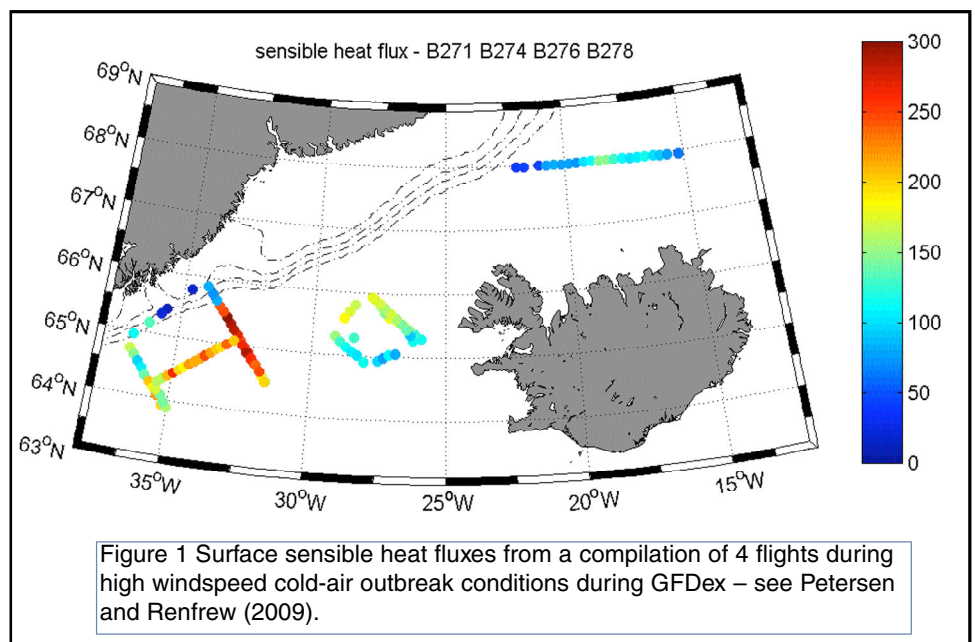



## U.S. CLIVAR

also a coordinated NASA aircraft-based component. Although limited to a 3 week ice drift, ASCOS probably represents the most comprehensive high Arctic field campaign since SHEBA in the late 1990s. See [www.ascos.se](http://www.ascos.se) for information and links.

In the Southern Ocean, the GAS-Ex III ([so-gasex.org](http://so-gasex.org)) field campaign based on the R/V Ron Brown took place in 2008, to the east of southern South America. Scientists from a number of institutions measured turbulence, waves, bubbles, temperature, ocean chemistry and biology, with the aim of investigating how these factors relate to the air-sea exchange of carbon dioxide and other climate-relevant gases. A comprehensive suite of instruments were on board to make direct motion-corrected covariance and inertial-dissipation flux measurements as well as associated forcing variables such as near-surface bulk meteorology, surface waves and whitecap fraction.

In the Nordic Seas, the ICEALOT (International Chemistry Experiment in the Arctic LOWER Troposphere) cruise took place in March and April 2008. Scientific issues being addressed include springtime sources and transport of pollutants to the Arctic, evolution of aerosols and gases into and within the Arctic, and climate impacts of haze and ozone in the Arctic. There is a focus on the ice-free Arctic in spring time; further information can be found at ([saga.pmel.noaa.gov/Field/icealot/](http://saga.pmel.noaa.gov/Field/icealot/)). While a circumnavigation of Arctic Canada was undertaken as part of the Circumpolar Flaw Lead System Study ([www.ipy-cfl.ca](http://www.ipy-cfl.ca)) by a Canadian ice breaker during 2008. This highly interdisciplinary study encompasses some legs with air-sea flux measurements of both physical and chemical quantities.

### Station-based experiments

In addition to the mobile field campaigns listed above, other IPY experiments have made use of permanent stations to kick start intensive field campaigns, with more longer-term monitoring efforts. OASIS (Ocean - Atmosphere - Sea Ice - Snowpack) is based out of Barrow in Alaska and has

Page 12

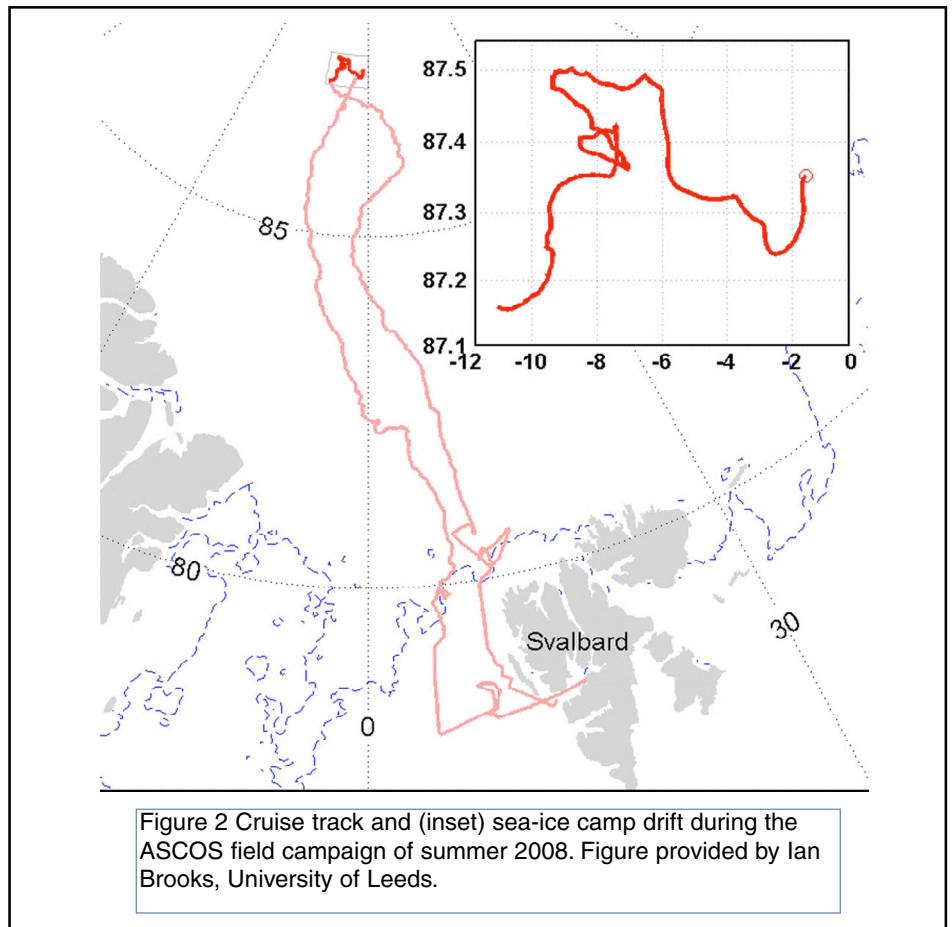

made use of coastal sites and various platforms to study chemical and physical exchange processes, with a focus on tropospheric chemistry and climate, as well as on the surface/biosphere and their feedbacks in the Arctic. A comprehensive website can be found at ([www.oasishome.net](http://www.oasishome.net)).

The above air-sea flux observations present an opportunity to validate atmosphere-ocean exchanges of physical and chemical quantities in the polar regions. I would hope that over coming years they are used to validate bulk-flux algorithms, meteorological analyses and reanalyses products and satellite-derived flux data sets with the aim of obtaining a better overall picture of this key component of the climate system.

### References

Fiedler, E., T. Lachlan-Cope, I. A. Renfrew, J. C. King, 2010: Convective heat transfer of thin-ice covered polynyas, *J. Geophysical Res. (Oceans)*, in press.

Petersen, G.N. and I.A. Renfrew, 2009: Aircraft-based observations of air-sea fluxes over Denmark Strait and the Irminger Sea during high wind speed conditions, *Quarterly J. Royal Meteorol. Soc.*, 135, 2030-2045.

Renfrew, I.A., G.W.K. Moore, J.E. Kristjánsson, H. Ólafsson, S.L. Gray, G.N. Petersen, K. Bovis, P.R.A. Brown, I. Føre, T. Haine, C. Hay, E.A. Irvine, A. Lawrence, T. Ohigashi, S. Outten, R.S. Pickart, M. Shapiro, D. Sproson, R. Swinbank, A. Woolley, S. Zhang, 2008: The Greenland Flow Distortion experiment, *Bull. Amer. Meteorol. Soc.*, 89, 1307-1324.

Renfrew, I.A., G.N. Petersen, D.A.J. Sproson, G.W.K. Moore, H. Adiwidjaja, S. Zhang, and R. North, 2009: A comparison of aircraft-based surface-layer observations over Denmark Strait and the Irminger Sea with meteorological analyses and QuikSCAT winds, *Quarterly J. Royal Meteorol. Soc.*, 135, 2046-2066.





# VARIATIONS

## Radiative Fluxes at High Latitudes

*R. T. Pinker and X. Niu*

*Department of Atmospheric and Oceanic Science, University of Maryland*

In the Arctic Climate Impacts Assessment Report (ACIC, 2004) it is stated: “over the past 50 years, it is probable (66-90% confidence) that Arctic amplification of greenhouse warming has occurred”. It is speculated that this amplification can be partly explained by the feedback associated with the high albedo of polar snow and ice. The extent of perennial sea ice has declined 20% since the mid-1970s (Serreze et al., 2007). The location of the reduced ice in spring and summer coincides with strongest solar radiation. If ice is lost, extra heat can be stored in these regions and remain through winter and reduce ice thickness the following spring. This ice-albedo feedback can accelerate the loss of ice.

Trend of cloud and surface properties derived from satellites for the period of 1982 to 1999 shows that the Arctic has warmed and became cloudier in spring and summer but has cooled and became less cloudy in winter (Wang et al., 2003). The increase in spring cloud amount radiatively balances changes in surface temperature and albedo, but during summer, fall, and winter, cloud forcing has tended toward increased cooling. Investigations using field data from the Arctic Alaska (Chapin et al., 2005) indicate that a lengthening of the snow-free season associated with the vegetation and summer albedo changes has increased regional warming by about 3 W m<sup>-2</sup> decade<sup>-1</sup>. This heating more than offsets the cooling caused by increased cloudiness.

Reduced ice in spring

and summer is important to the climate system because the timing coincides with strongest solar radiation, of which ice is an excellent reflector. If enough ice is lost to allow sufficient extra heat enter into the Polar Regions, and some can remain through the winter and reduce ice thickness the following spring, the ice-albedo feedback will accelerate the loss of ice. Therefore, accurate estimates of the shortwave fluxes would be important for investigating causes for ice loss, especially for the extreme ice loss in 2005 and 2007.

Observations and model simulations of radiative flux estimates over Polar Regions are not consistent. The Polar Regions are data sparse with very few in-situ observations. An alternative approach is to use reanalysis data-sets, or use satellite observations. Recent studies (Liu et al., 2005) indicate that the surface downward shortwave radiative fluxes derived from satellites are more accurate than the two main reanalysis dataset (NCEP and ECMWF), due to the better representation of cloud properties in the satellite products. During the Surface Heat

Budget and the Arctic Ocean (SHEBA) project it was shown that satellite-based analysis may provide downward short-wave (long wave) radiative fluxes to within ~ 10-40 (~10-30) W/m<sup>2</sup> compared with ground observations (Perovich et al., 2007).

### Needs

To better understand the ice-albedo feedback over Polar Regions, there is a need for accurate estimates of surface shortwave radiative fluxes which can be provided only by satellites. At present, large scale estimates of radiative fluxes from satellite observations are available at scales ranging from 25 km to 2.5 degrees (Wang and Key., 2005; Zhang et al., 2004). To improve the representation of variability in ice extent in the inference schemes for deriving surface radiative fluxes, it is desirable to increase the spatial scale of the satellite observations. As evident from Figure 1, most of the disagreement between two satellite products one at 10 and the other at 2.5 is at the sea-ice boundaries which are difficult to resolve at such scales in the boundary conditions in the radiative transfer computations.

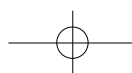
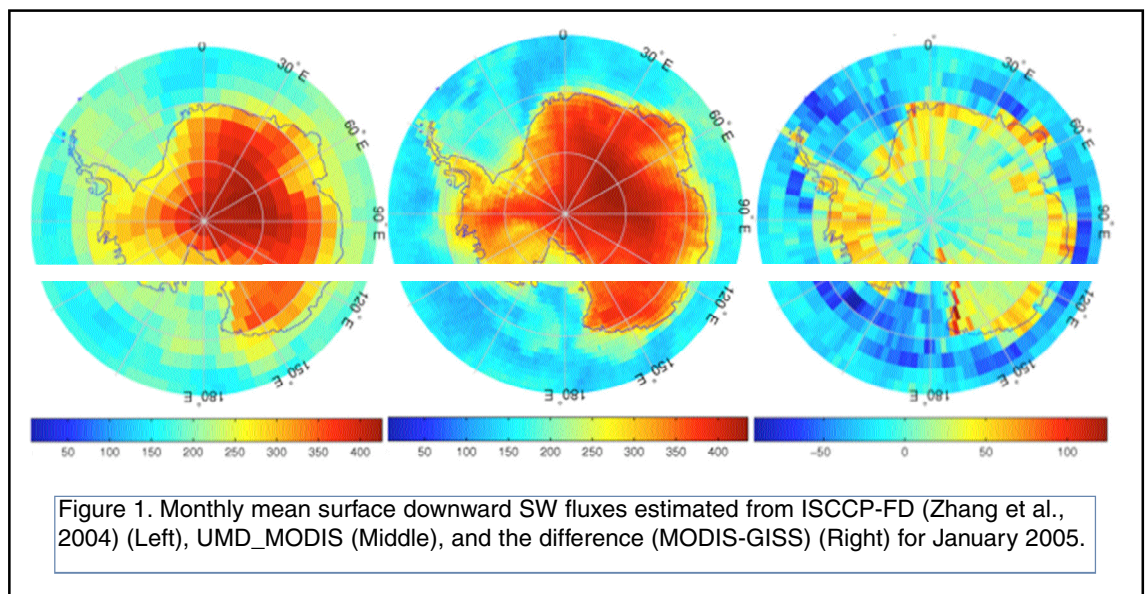



# U.S. CLIVAR

(from page 7)

Satellite observations would benefit from having certain observations from different instruments (currently on different satellites) closely located in time and space. This could be achieved with a single satellite (e.g., GCOM-W2 with an AMSR2 and a Dual Frequency Scatterometer), or by placing the satellite in an A-Train like formation (Bourassa et al., 2010). An accuracy of  $5\text{Wm}^{-2}$  in net energy fluxes is considered a desirable, albeit challenging, target for the combined satellite and in situ observing system, for atmospheric synoptic scale variability. An estimate of the accuracy of the observation time would also be useful. It was also suggested that the surface flux community investigate what is needed to move towards a GHRSSST-like program for surface fluxes.

One significant topic of discussion focused on improving access to both observations and reanalyses, as this would benefit a broad range of user communities. Workshop participants noted that data users sometimes select flux-related data products primarily on the basis of the time period covered, the specific variables available, or even the convenience of finding data, without consideration for the appropriateness of the data set for a particular application. Information regarding the quality and nature of flux-related data sets should be made easily available and would help users assess data efficiently. Product developers are encouraged to provide their data sets to data centers so that data can easily be found. Data centers are encouraged to provide all meta-data about the qualities of the data in an easily interpreted form, so that users can readily identify appropriate data sets. For example, one suggestion is that NASA science teams develop a specific set of metrics (e.g., determining the resolution of products, biases, and uncertainties) and techniques (e.g., power density spectra) for evaluating data products related to the team activities and that the science teams and data centers disseminate these evaluations with their data.

## References

- Bourassa, M., S. Gille, D. L. Jackson, B. J. Roberts, and G. A. Wick, 2010: Ocean Winds and Turbulent Air-Sea Fluxes Inferred From Remote Sensing. *Oceanography* (submitted).
- Gulev, S.K., T. Jung, and E. Ruprecht, 2010. Estimation of the impact of sampling errors in the VOS observations on air-sea fluxes. Part I. Uncertainties in climate means. *J. Climate*, 20, 279-301.
- Gulev, S.K., T. Jung, and E. Ruprecht, 2010. Estimation of the impact of sampling errors in the VOS observations on air-sea fluxes. Part II. Impact on trends and interannual variability. *J. Climate*, 20, 302-315.
- Kay, J. E., Raeder, K., A. Gettelman and J. Anderson, 2010. The boundary layer response to recent Arctic sea ice loss and implications for high-latitude climate feedbacks, submitted to *J. Climate*.
- Uttal, T., J. A. Curry, M. G. McPhee, D. K. Perovich, R. E. Moritz, J. A. Maslanik, P. S. Guest, H. L. Stern, J. A. Moore, R. Turenne, A. Heiberg, M. C. Serreze, D. P. Wylie, O. G. Persson, C. A. Paulson, C. Halle, J. H. Morison, P. A. Wheeler, A. Makshtas, H. Welch, M. D. Shupe, J. M. Intrieri, K. Stamnes, R. W. Lindsey, R. Pinkel, W. S. Pegau, T. P. Stanton, and T. C. Grenfeld, 2002. Surface Heat Budget of the Arctic Ocean, *Bull. Amer. Met. Soc.*, 83(2), 255-275.
- Vancoppenolle, M., R. Timmermann, S.F. Ackley, T. Fichefet, H. Goosse, P. Heil, J. Lieser, K.C. Leonard, M. Nicolaus, T. Papakyriakou and J.-L. Tison, 2010. Assessment of radiation forcing data sets for large-scale sea ice models in the Southern Ocean. In press, *Deep-Sea Res.*

Consequently, errors are introduced in the estimates of the surface heating, which in turn, affect the ice melt computations.

Similar discrepancies have been noted in numerical models. The comparison of the surface energy budget over the Arctic (70-90°N) from 20 coupled models for the IPCC fourth Assessment with 5 observationally based estimates and re-analysis shows that the simulation of the Arctic surface energy budget has large bias in climate models and the largest differences are located over the marginal ice zones (Sorteberg et al., 2007).

### Advantages of MODIS for improving SW radiation budget

Page 14

Instruments onboard the new generations of sun synchronous satellites tend to have higher spatial and spectral resolution than those on earlier satellites, thus improving capabilities to detect atmospheric and surface parameters. The Moderate Resolution Imaging Spectroradiometer (MODIS) instrument onboard the Terra and Aqua satellites is a state-of-the-art sensor with 36 spectral bands with an onboard calibration of both solar and infrared bands. The wide spectral range (0.41-14.24  $\mu\text{m}$ ), frequent global coverage (one to two days revisit), and high spatial resolution (250 m for two bands, 500 m for five bands and 1000 m for 29 bands), permit global monitoring of atmospheric profiles, column water vapor amount, aerosol properties, and clouds, at higher accuracy

and consistency than previous Earth Observation Imagers (King et al., 1992).

An inference scheme was developed to utilize information from MODIS instruments to estimate spectral SW radiative fluxes (UMD\_MODIS) (Wang and Pinker, 2009). The model was implemented with MODIS products at 10 spatial resolution from Terra and Aqua and evaluated against ground measurements over ocean and land sites both at monthly and daily time scales. Over oceans the Pilot Research Moored Array in the Atlantic (PIRATA) and the Tropical Atmosphere Ocean (TAO) Triangle Trans-Ocean Buoy Network (TRITON) Array were used; over land the Baseline Surface Radiation Network (BSRN) was used. Evaluation of

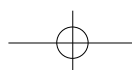

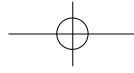

## VARIATIONS

monthly mean surface downward short-wave flux estimated using the UMD\_MODIS model against PIRATA and TAO/TRITON buoy observations (January 2003-December 2005) against PIRATA and TAO/TRITON buoy observations (January 2003-December 2005) has shown for the PIRATA array the correlation coefficient was 0.90, RMSE 13 (5%) and bias 2 (1%). For the TAO/TRITON Array the corresponding values were 0.94, 11 (5%) and -1 (0%). Details are presented in (Pinker et al., 2009).

### Summary

The quality of information on surface SW radiative fluxes at high latitudes as available from MODIS observations from both Terra and Aqua at monthly and daily time scales was evaluated. Used were observations as available for the BSRN network over land and from buoys as far north as available. The resolution of the satellite products is 10 and as such, not optimal for sites which are mostly coastal. Possibly, this is the reason that the results for the buoy observations seem to be better than over the land location, due to the “homogeneity” of the oceanic sites. Much smaller differences between the MODIS estimates and ocean and land sites at lower latitudes are found, possibly, due to the

fact that the land sites are inland.

At high latitudes where the variability of ice extent is an issue, it is believed that the high resolution 5-km product from MODIS is needed to properly estimate the amount of radiant energy reaching the surface and its correct determination by specifying the nature of the underlying surface in the inference schemes. An example of such product for different swaths over the North Pole is shown in Figure 7. In order to cover the entire polar region for each local time, there is a need to “stitch” together about 28 orbits. This is feasible and fortunately, MODIS has about 7 observations per day at latitudes above 70° North and South which provides a very good representation of the diurnal cycle.

It is believed that the accuracy of the fluxes in these regions can be improved by utilizing the high resolution MODIS products, improved inference schemes, and taking advantage of improved ground observations to evaluate the new estimates. In particular, more accurate data on surface condition, such as ice extent, atmospheric information, such as aerosol optical properties, improved models of narrow to broadband trans-

formations with realistic surface models and newly available bi-directional distribution functions (BRDF) models (e. g., from CERES or MISER) need to be utilized. Observations from ClouSat can be used for evaluation of the MODIS based methodology.

### References

- Serreze, M. C., M. M. Holland, and J. Strove, 2007. *Perspectives on the Arctic's shrinking sea-ice cover*. *Science*, 315, 1533-1536, doi: 10.1126/science.1139426.
- Arctic Climate Impact Assessment, 2004. *Impacts of a Warming Arctic: Arctic Climate Impact Assessment*. Cambridge Univ. Press, New York, 139.
- Liu, J., J. A. Curry, W. B. Rossow, J. R. Key, and X. Wang, 2005. *Comparison of surface radiative flux data sets over the Arctic Ocean*. *Journal of Geophysical Research*, 110, C02015, doi: 10.1029/2004JC002381, 1-13.
- Ohmura, A., et al. (1998). *Baseline Surface Radiation Network (BSRN/WCRP): New precision radiometry for climate research*. *Bull. Am. Meteorol. Soc.*, 79, 2115–2136
- Pavolonis, M. J., J. R. Key, and J. J. Cassano, 2003. *A study of the Antarctic Surface Energy Budget Using a Polar Regional Atmospheric Model Forced with Satellite-Derived Cloud Properties*. *Monthly Weather Review*, 132, 654-661.
- Perovich, D. K., B. Light, H. Eicken, K. F. Jones, K. Runciman, and S. V. Nghiem, 2007. *Increasing solar heating of the Arctic Ocean and adjacent seas, 1979-2005: Attributing and role in the ice-albedo feedback*. *Geophysical Research Letters*, 34, L19505, doi: 10.1029/2007GL031480.
- Wang, X., and J. R. Key, 2005. *Arctic Surface, Cloud, and Radiation Properties based on the AVHRR Polar Pathfinder dataset. Part I: spatial and temporal characteristics*. *J. Clim.*, 18, 2558-2574.
- Wang, H., and R. T. Pinker, 2009. *Shortwave radiative fluxes from MODIS: Model development and implementation*. *JOURNAL OF GEOPHYSICAL RESEARCH-ATMOSPHERES*, 114, D20201.
- Pinker, R. T.; Wang, H., Grodsky, S. A., 2009. *How good are ocean buoy observations of radiative fluxes?* *GEOPHYSICAL RESEARCH LETTERS*, 36, L10811.
- Zhang, Y. C., Rossow, WB; Lacis, AA, et al., 2004. *Calculation of radiative fluxes from the surface to top of atmosphere based on ISCCP and other global data sets: Refinements of the radiative transfer model and the input data*. *JOURNAL OF GEOPHYSICAL RESEARCH-ATMOSPHERE*, 109 (D19), D19105.

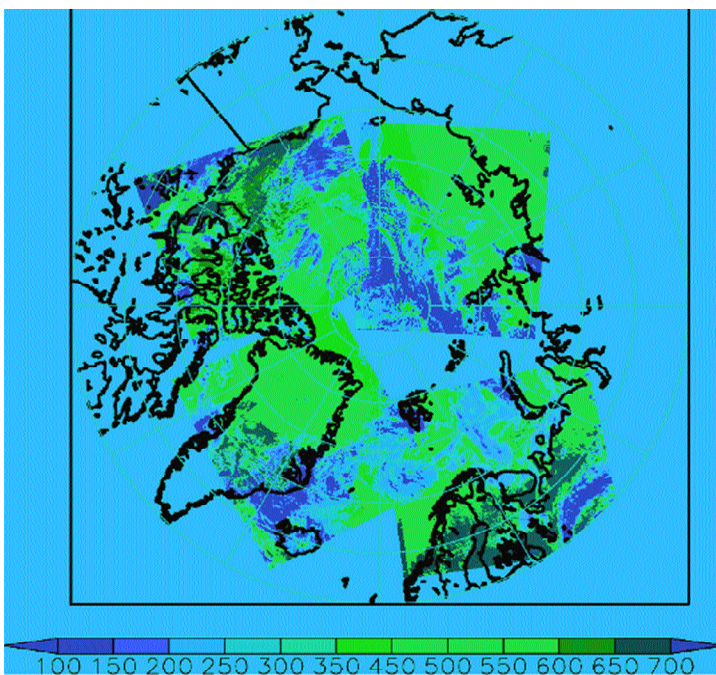

Figure 2. The surface downward SW fluxes ( $Wm^{-2}$ ) over Arctic Regions ( $60^{\circ}$ - $90^{\circ}$ N) using 4 granules overpass around 11:30 am Local Time for July 1, 2005.





# U.S. CLIVAR

## Calendar of CLIVAR and CLIVAR-related meetings

Further details are available on the U.S. CLIVAR and International CLIVAR web sites: [www.usclivar.org](http://www.usclivar.org) and [www.clivar.org](http://www.clivar.org)

### Atlantic Meridional Overturning Circulation Annual Meeting

7-9 June 2010

Miami, FL

Attendance: Limited

<http://www.atlanticmoc.org>

### WCRP Extremes Workshop

21-23 June 2010

Paris, France

Attendance: Invited

<http://www.wmo.ch/pages/prog/wcrp/wcrp-index.html>

### AGU Western Pacific Geophysics Meeting

22-25 June 2010

Taipei, Taiwan

Attendance: Open

<http://www.agu.org/meetings/wp10/>

### Community Climate System Model (CCSM) Annual Meeting

28 June - 2 July 2010

Breckenridge, CO

Attendance: Limited

<http://www.cesm.ucar.edu/events/ws.2010/>

### US CLIVAR Summit

7-9 July 2010

Denver, CO

Attendance: Invited

<http://www.usclivar.org>

### Aquarius Science Meeting

7-9 July 2010

Seattle, WA

Attendance: Invited

<http://depts.washington.edu/uwconf/aquarius/>

### Meeting of the Americas

8-12 August 2010

Iguassu Falls, Brazil

Attendance: Open

<http://www.agu.org/meetings/ja10/>

### XBT Fall Rate Workshop

25-27 August 2010

Hamburg, Germany

Attendance: Invited

### CLIVAR Working Group on Ocean Model Development Workshop/Meeting

20-24 September 2010

Boulder, CO

Attendance: Limited

### NOAA Climate Diagnostics and Prediction Workshop

4-8 October 2010

Raleigh, NC

Attendance: Open

<http://www.cpc.ncep.noaa.gov/products/outreach/CDPW35.shtml>

### Workshop on ENSO, Decadal Variability and Climate Change in South America

12-14 October 2010

Guayaquil, Ecuador

Attendance: Open

[http://www.clivar.org/organization/pacific/meetings/enso/enso\\_2010.php](http://www.clivar.org/organization/pacific/meetings/enso/enso_2010.php)

### CLIVAR Reanalysis Workshop

1-5 November 2010

Baltimore, MD

Attendance: Open

<http://www.usclivar.org/Reanalysis2010.php>

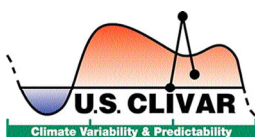

### U.S. CLIVAR OFFICE

1717 Pennsylvania Avenue, NW  
Suite 250  
Washington, DC 20006

Subscription requests, and changes of address should be sent to the attention of the U.S. CLIVAR Office ([cstephens@usclivar.org](mailto:cstephens@usclivar.org))



U.S. CLIVAR contributes to the CLIVAR Program and is a member of the World Climate Research Programme

