

Watch Out...

STORMS
AHEAD!

OWLIE SKYWARN'S WEATHER BOOK



FEMA



American Red Cross



FEMA



What's Inside:

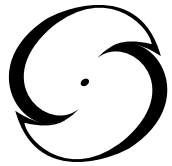

Hurricanes pg 3

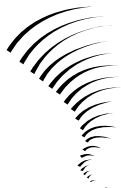

Tornadoes pg 7



Lightning pg 13



Floods pg 17



Winter Storms pg 22



Weather Quizzes pg 29

Owlie Skywarn's Weather Book

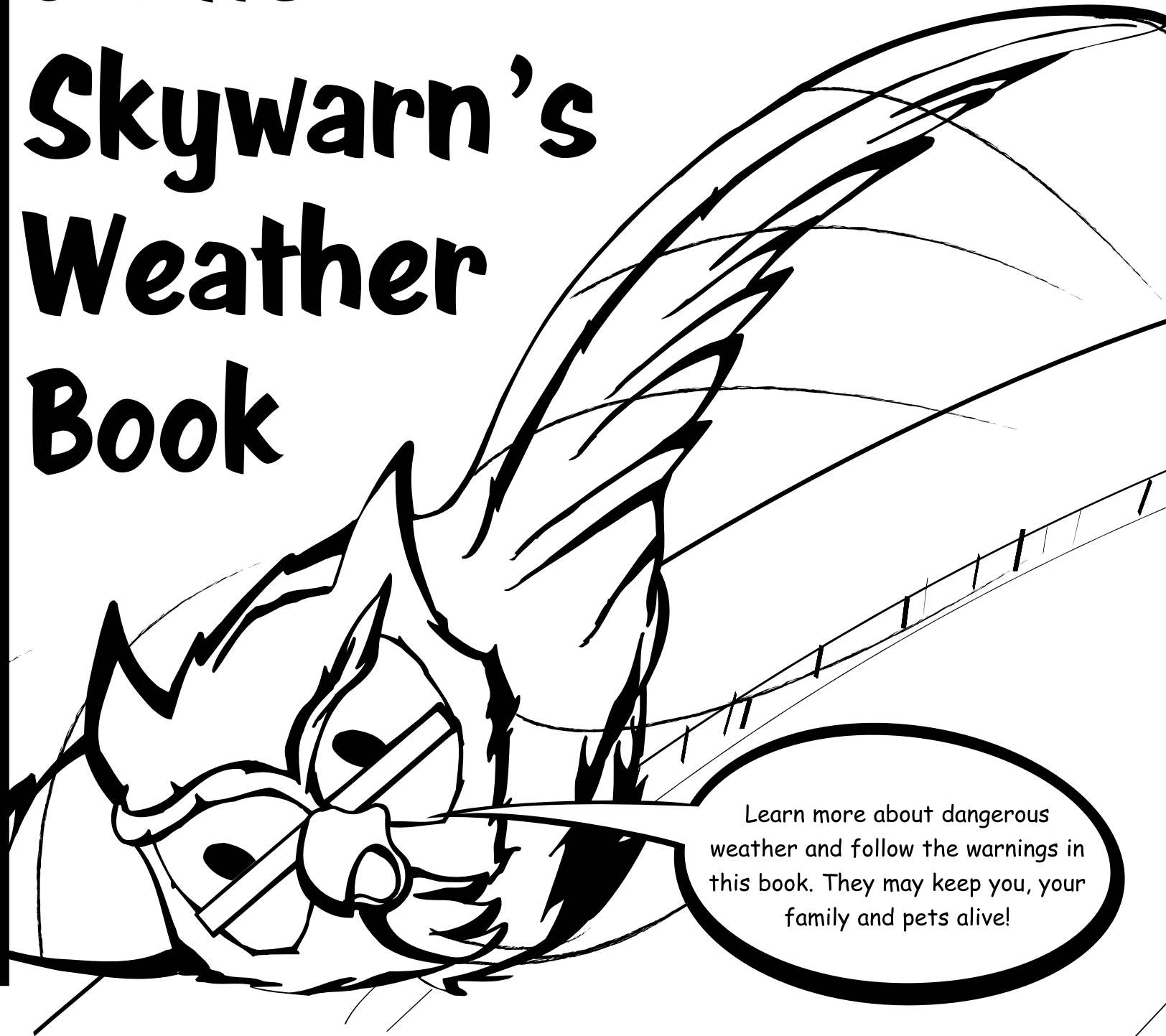

Learn more about dangerous weather and follow the warnings in this book. They may keep you, your family and pets alive!

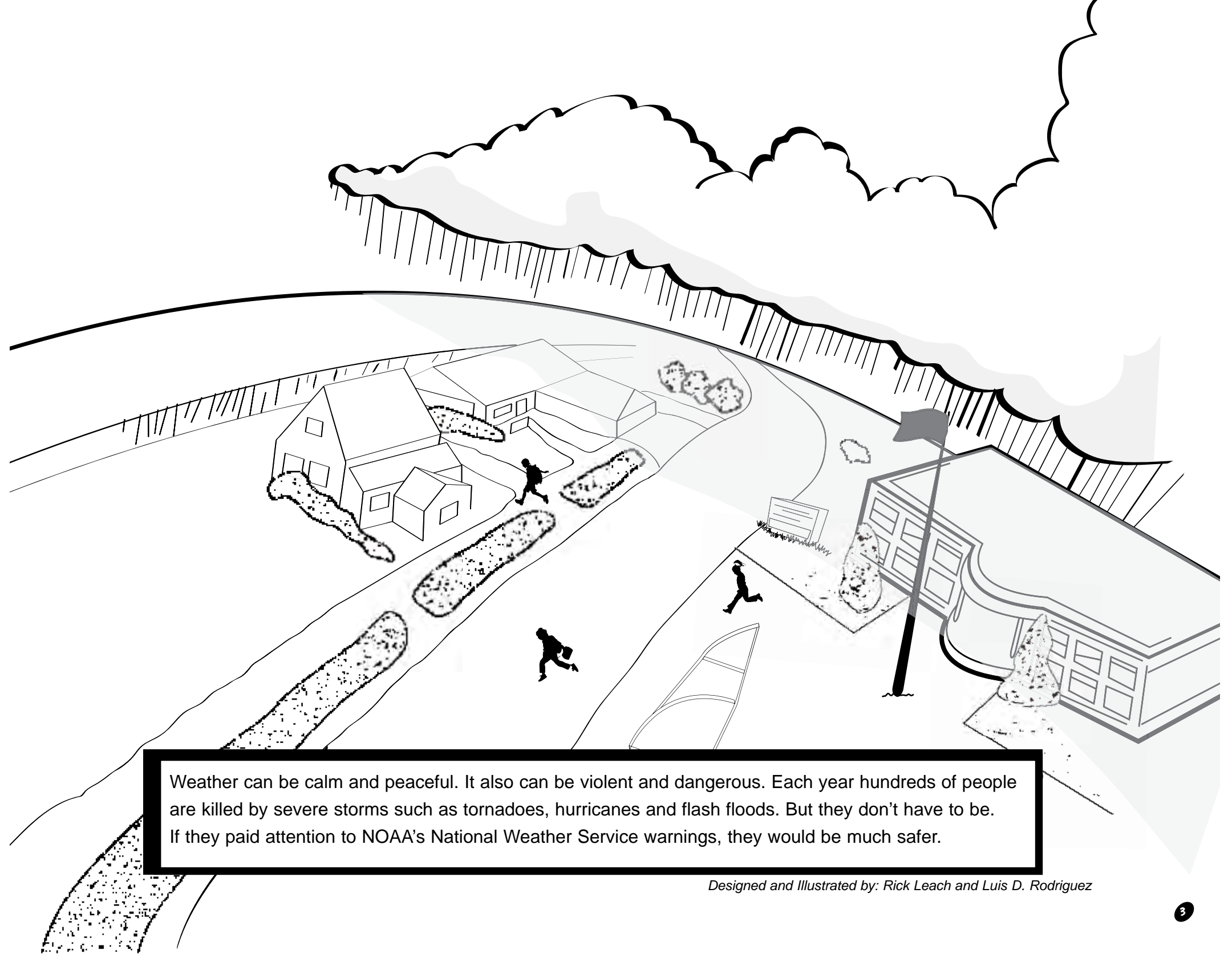

Weather can be calm and peaceful. It also can be violent and dangerous. Each year hundreds of people are killed by severe storms such as tornadoes, hurricanes and flash floods. But they don't have to be. If they paid attention to NOAA's National Weather Service warnings, they would be much safer.

Designed and Illustrated by: Rick Leach and Luis D. Rodriguez

Hurricanes

The air that surrounds our planet weights 5,000,000,000,000,000 (5 quadrillion) tons! That's 13,700,000,000 (13 billion, 700 million) Empire State Buildings!

Air is moving all the time—swirling, blowing, sinking, rising. In summer and early fall, great masses of air move over the warm oceans. The oceans get hot, pick up lots of water and start swirling, blowing, sinking and rising.

A hurricane is born. If the hurricane moves toward the shore, powerful winds, high tides and flooding could wipe out cities, towns, farms and schools.

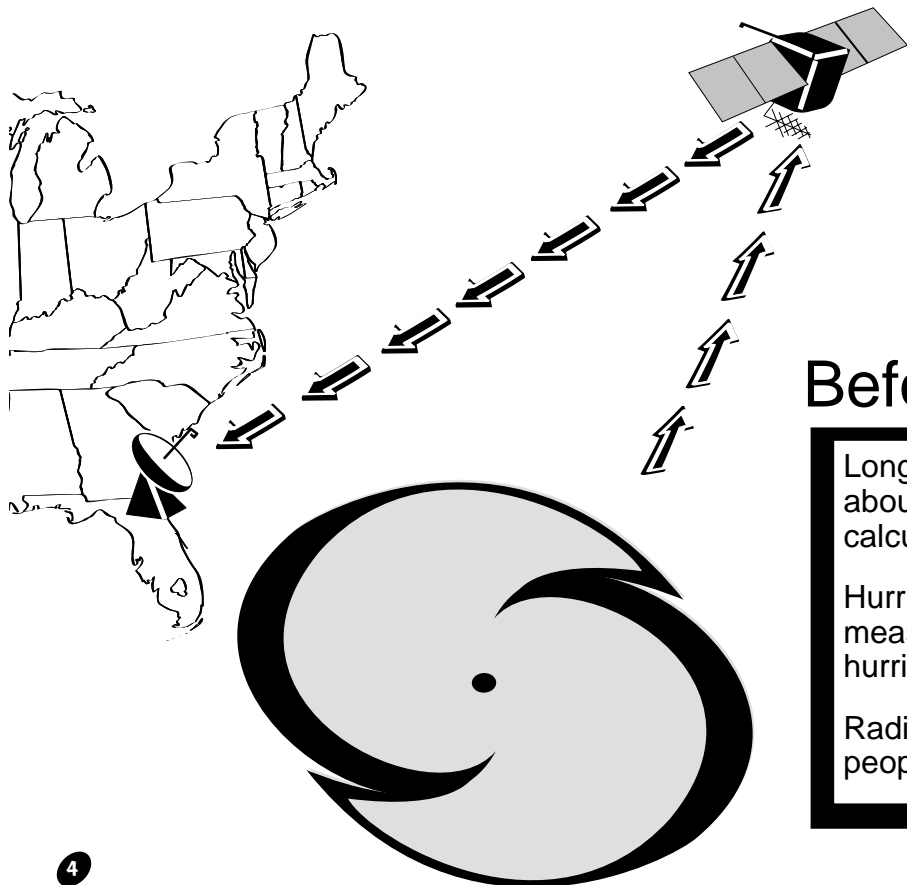
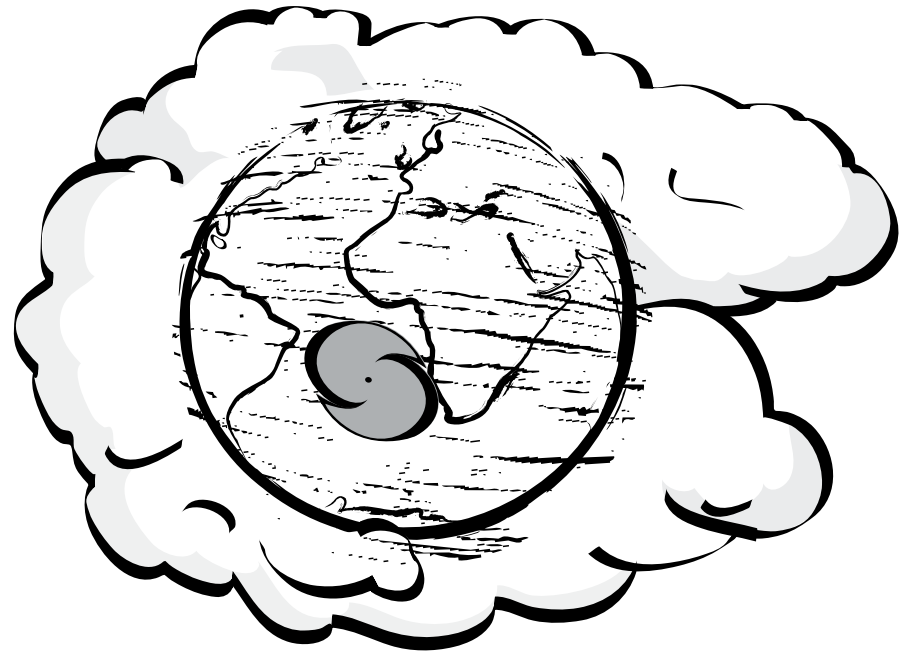

Before the hurricane reaches you . . .

Long before a hurricane hits land, the National Weather Service knows about it. Satellites have taken pictures of the storm and computers have calculated where it is going.

Hurricane Hunter airplanes fly into the storm and report more exact measurements. As it comes closer to land, special weather radars track the hurricane.

Radio, television and more than 1000 NOAA Weather Radio stations warn people about the hurricane. It may reach land. Get ready!

Before the Storm Comes . . .

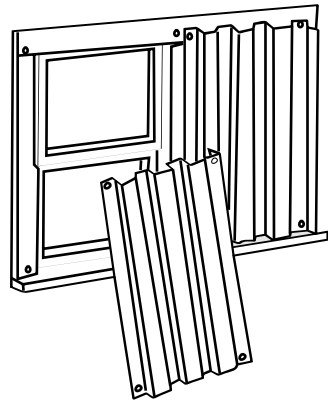

Put boards or storm shutters over windows. Do NOT tape the windows. Taping just leaves gunk on your windows, it doesn't protect them.

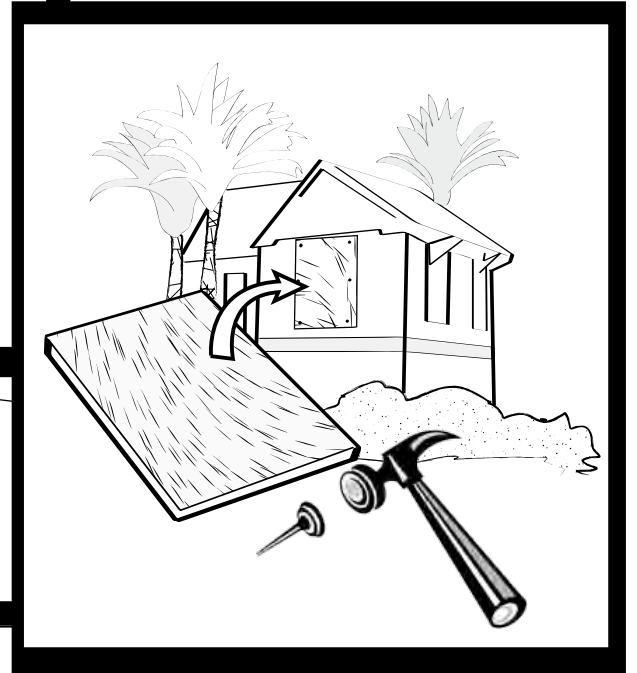

Pick up all the small things laying around your yard, like toys, tools and flower pots and bring them inside. The wind could pick them up and send them slamming into windows, cars or you!

If you're not close to shore and plan to stay in your home during the storm, clean drains and prepare for flooding. Always evacuate immediately if ordered to do so!

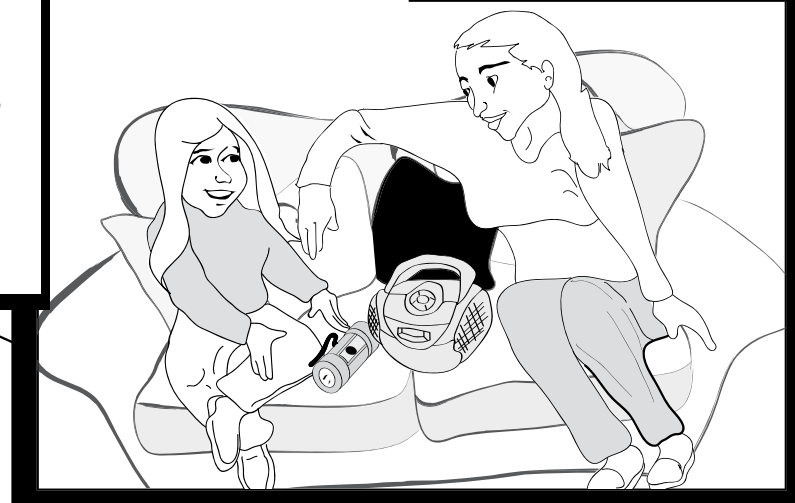

When National Weather Service meteorologists decide a storm might reach land within 2 days, they issue a Hurricane Watch. In the western North Pacific, hurricanes are called typhoons. Both have a well-defined circulation and sustained winds over 73 miles per hour. A Watch tells people who live or work near the coast that the hurricane will likely impact them. The National Weather Service works together with emergency managers and the news media. We will tell you what is happening. Stay tuned!

Hurricane Warning

When the National Weather Service puts out a Hurricane Warning for your area, it means the storm is likely to generate winds more than 73 miles per hour! That's hard enough to blow down trees and other big objects that could hit you or your home. Ouch! A Warning also means dangerous high water, coastal flooding and very rough seas are expected. Hurricanes also create lots of thunderstorms with deadly lightning and even some tornadoes. You definitely need to seek safe shelter during a hurricane. Listen to what the emergency managers in your state are advising. They might tell you to get away from the coast and inland to safety.

Get out when you are told.

When the hurricane hits, the sea may rise as high as 25 feet above normal high tide! That is taller than six kids standing on each other's shoulders!

This extreme coastal flooding due to hurricanes is called the storm surge. The surge can sink boats, destroy piers and damage buildings. Many people who die during a hurricane drown from inland flooding—not due to the high winds.

In a major hurricane, wind speed may be more than 150 miles per hour! Trees are blown down and houses can be damaged. Windows in buildings are blown out. Watch out for flying debris!

It rains hard in hurricanes. Slow moving storms produce more rain. There may be flooding hundreds of miles from the coast due to heavy rain.

When the Hurricane Comes . . .

Stay safe by staying indoors. Falling trees, flying debris, downed power lines, flooded roads—it is just not safe to be outdoors. Any decision to evacuate the coast should be made well in advance of the storm's arrival. Follow the guidance of the emergency managers in your area.

Beware of the eye of the hurricane. A hurricane is a big doughnut of wind with a calm section at the middle.

- The whole hurricane can be 300 miles across. The calm center may last from a few minutes to an hour.
- The sun may even come out in the eye and you might think the storm is over. But it isn't. As the hurricane moves on, winds will blow just as hard, but from the opposite direction.

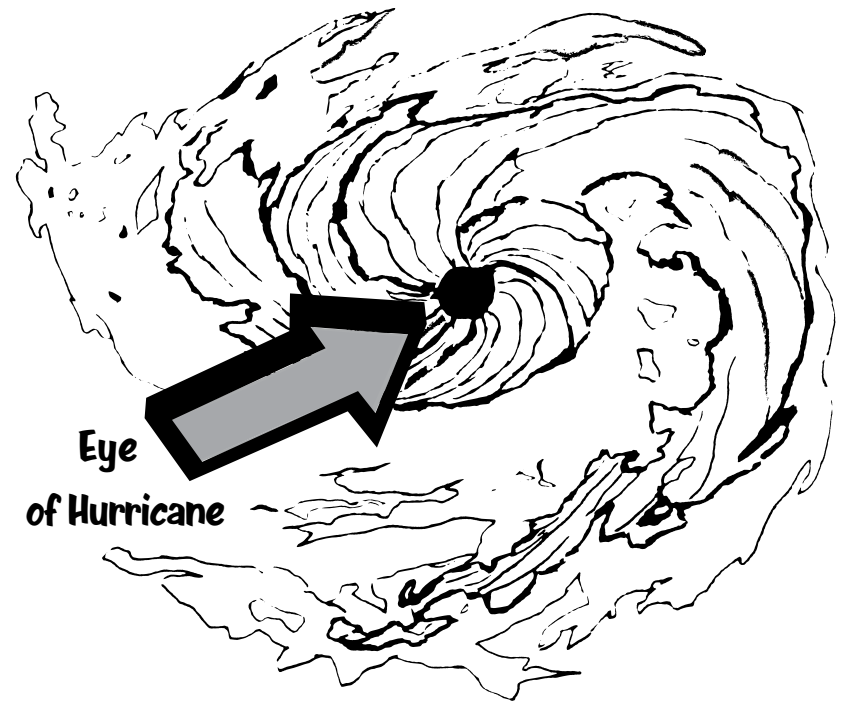

Have flashlights, a radio, and extra batteries in case you lose electricity. A first aid kit also is important to have on hand. Visit <http://www.ready.gov/america/getakit/index.html> for more information.

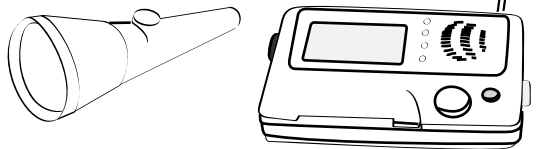

Hurricanes and

Tropical Storms can kill. Don't be caught by one!

Ensure you have enough water and food stocked up. Water—1 gallon per person, per day (2 week supply for home). Food—2 week supply of non-perishable food. And don't forget food and water for your pets!



**Get out of its way.
Go inland. Do it
immediately!**

Tornadoes



If you ever see a big, black cloud with a funnel shaped cloud beneath it, watch out. It could be a tornado.

A tornado looks like a funnel with the fat part at the top. Inside winds may swirl up to 200 miles an hour.

If it goes through a town, the tornado could flatten homes and buildings, throw cars and trucks through the air and shatter mobile homes into splinters.

It could just hit your home and leave your neighbor's home alone or could destroy an entire town.

Sometimes you don't see the funnel first. It may be raining too hard. Or the tornado may come at night. Listen for the tornado's roar—it sounds like 1,000 trains coming!

Tornado Watch

The National Weather Service forecasts that a tornado **MAY** develop later. The sky may be clear at the time you hear the Watch. Don't be fooled. Listen to the radio for the latest news and get to safety.

Tornado Warning

When someone has seen a tornado or radar detects one, the NWS issues a **Warning**. The tornado may be moving toward you! Dark clouds swirl in the sky. There may be thunder, lightning, heavy rain or hail. When you see large hail, you may be close to a tornado. Power may go off. You should already be inside!

What to do In Your Home ...



When you hear the Tornado **Watch**, keep your eye on the sky for signs of a possible tornado and listen to the radio for the latest weather news from the National Weather Service.



Go to the basement or shelter if you have one. Get under a heavy workbench or the stairs.

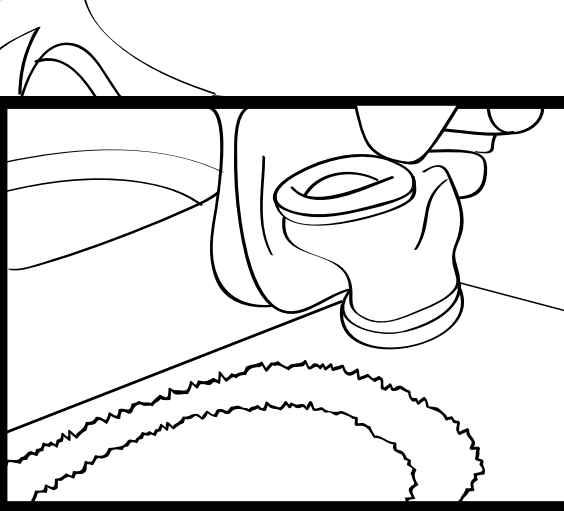

If there is no basement, go to a closet on an inside wall, a bathroom, or hallway on the lowest level of the house.

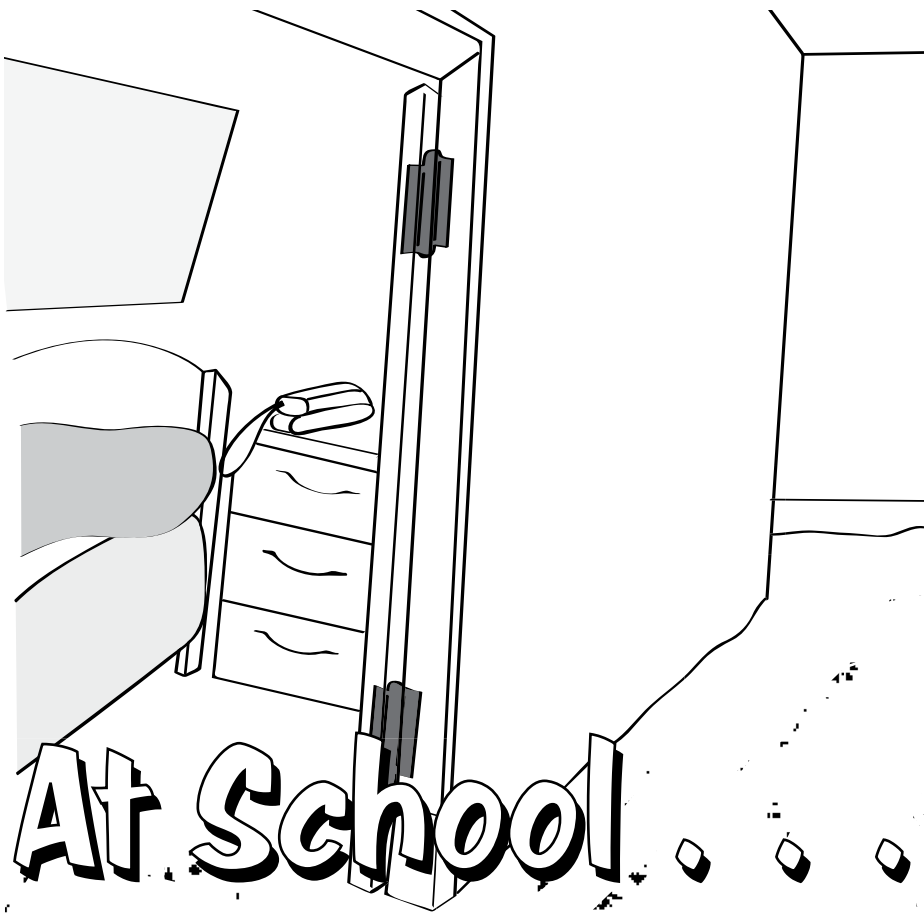

Outside . . .

- Immediately seek shelter in a nearby sturdy building, shelter or basement.
- If you're caught outside, crouch low in a ditch or crouch near a strong building.
- Cover your head with your hands.

In a car or truck...

- Immediately go to a nearby sturdy building, shelter or basement.
- If flying debris occurs while you are driving, pull over and park. Now you have the following options as a last resort:
- Stay in the car with the seat belt on. Put your head down below the windows, covering with your hands and a blanket if possible.
- If you can safely get noticeably lower than the level of the roadway, exit your car, and lie in that area, covering your head with your hands.
- If you can safely get noticeably lower than the level of the roadway, exit your car, and lie in that area, covering your head with your hands.
- Your choice should be driven by your specific circumstances.

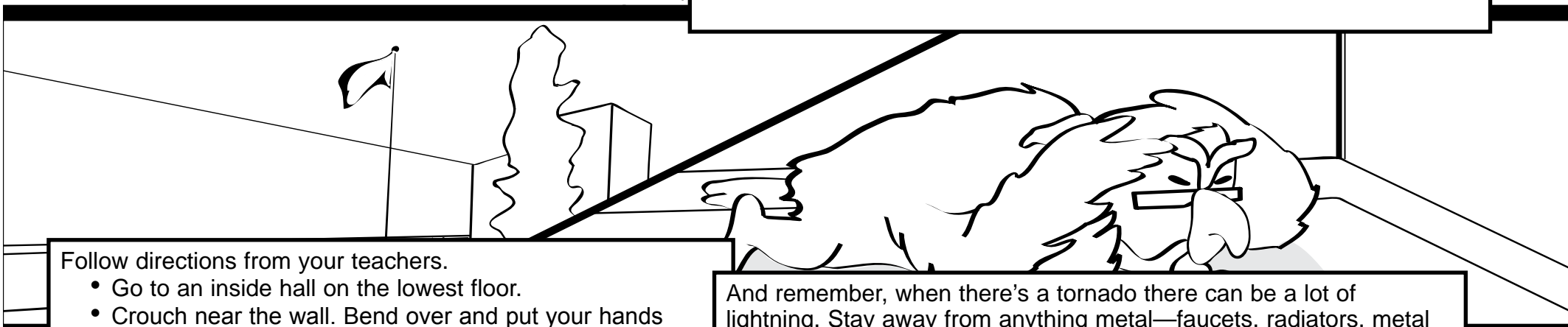

Follow directions from your teachers.

- Go to an inside hall on the lowest floor.
- Crouch near the wall. Bend over and put your hands on the back of your head.
- Keep away from glass windows and stay out of big rooms like the gym, cafeteria or auditorium.
- Listen to NOAA Weather Radio or a battery powered radio for warnings.

And remember, when there's a tornado there can be a lot of lightning. Stay away from anything metal—faucets, radiators, metal sinks and tubs.

Tornadoes are scary. They pack a lot of energy, enough to blow down a whole town! But you can live through a tornado. Be smart. Know what to do and do it!

Owlie's True Tornado Facts

In Texas, a mother huddled in an inside closet with six children. A tornado ripped off the roof of their house, tore down one wall and destroyed their garage. But all seven people in the closet weren't even scratched.

In 1931, a tornado in Minnesota lifted an 83-ton railroad train with 117 passengers and carried it for 80 feet.

Tornadoes are rare in many parts of the United States, but they have occurred in all 50 states.

In a Mobile Home or Trailer

Mobile homes and trailers are not safe during tornadoes. If you live in a mobile home or trailer you should plan in advance where the nearest shelter or sturdy structure is located. If a tornado is spotted or a warning issued for your area, GET OUT! Act on your plan to safely evacuate until the danger passes.

In Mississippi, a mother and her daughter sought shelter in their bathtub. After the tornado hit, the only room left was the bathroom.

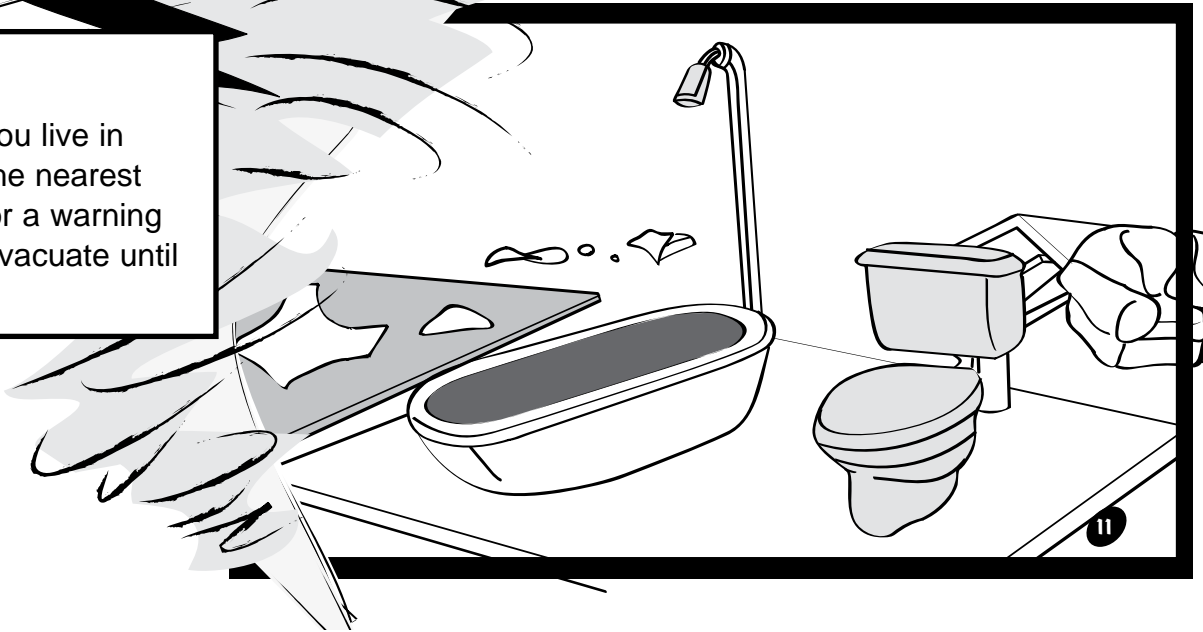



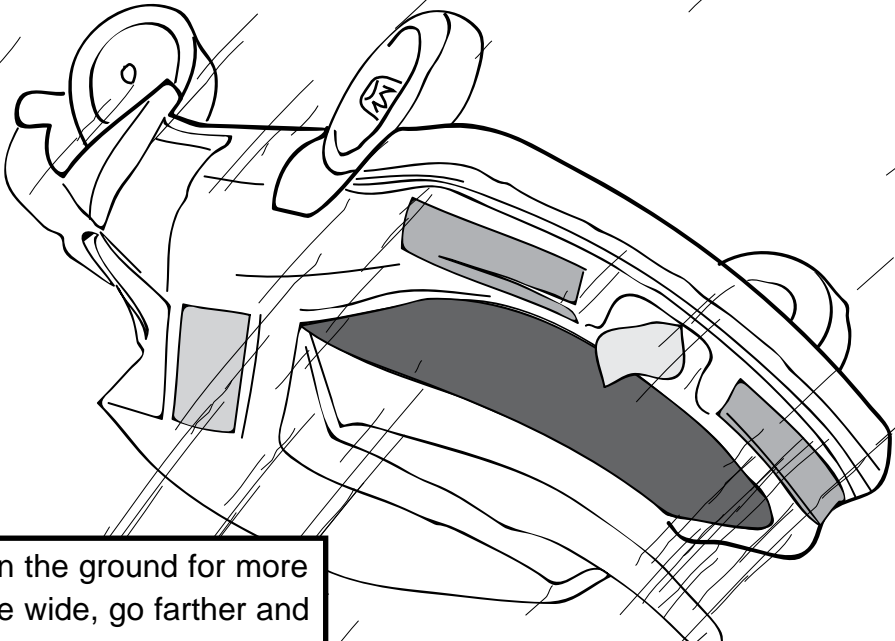

Most tornadoes are narrow and seldom stay on the ground for more than 15 miles. But the wider ones, up to a mile wide, go farther and are the biggest killers.

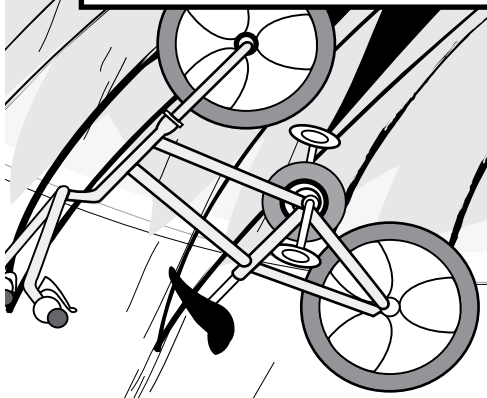

One town, Codell, Kansas, was struck three times: In 1916, 1917 and 1918—each time on May 20.

In 2011, an EF5 tornado, with winds over 200 mph, the most dangerous kind, struck Joplin, MO, with winds more than 200 miles per hour. The tornado killed more than 140 people and destroyed more than 8,000 homes as well as 300 businesses, including a hospital.

Lightning

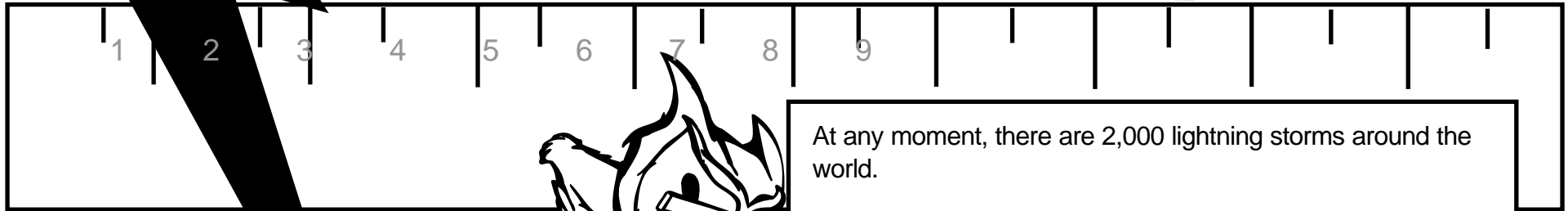

At any moment, there are 2,000 lightning storms around the world.

Almost every day someone is struck by lightning. Most of these people survive—with lifelong health problems—but many are killed. In the United States about 50 people die each year from lightning or from fires caused by lightning.

In addition to lightning, thunderstorms also produce strong winds and hail. Some hail may be as big as golf balls or baseballs. Thunderstorms occur all year but are most common in spring and summer.

Before a Storm

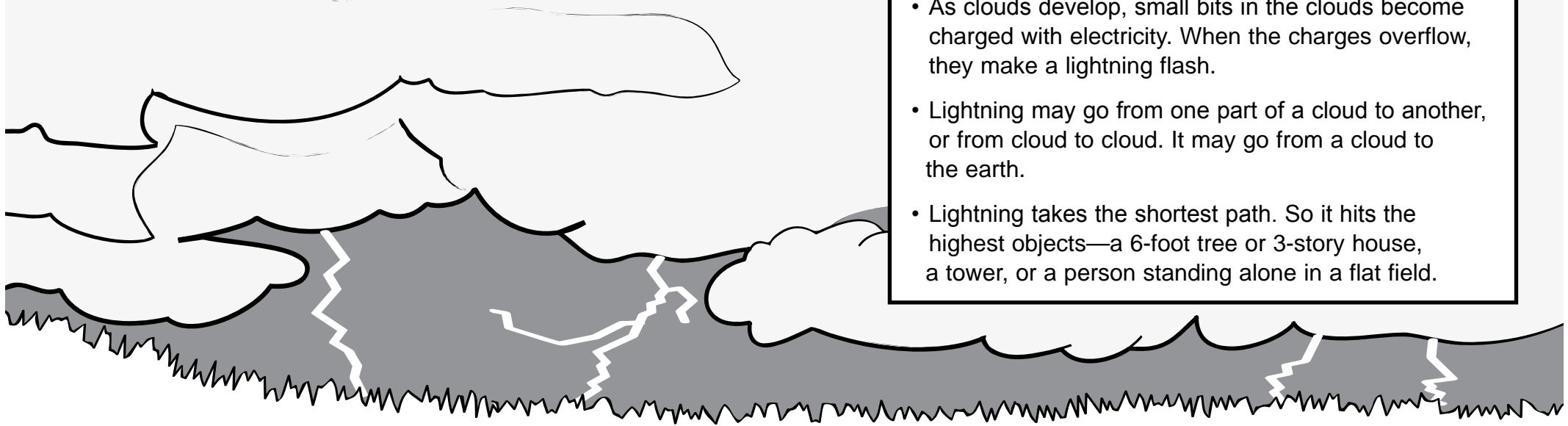

- Keep an eye on the sky. On a hot day, clouds build up. They grow larger, towering higher and higher. They darken. The top of the clouds may be spread out by winds at high altitudes.
- As clouds develop, small bits in the clouds become charged with electricity. When the charges overflow, they make a lightning flash.
- Lightning may go from one part of a cloud to another, or from cloud to cloud. It may go from a cloud to the earth.
- Lightning takes the shortest path. So it hits the highest objects—a 6-foot tree or 3-story house, a tower, or a person standing alone in a flat field.

Lightning may hit the same place or person several times.

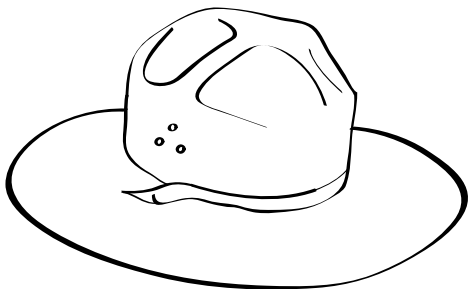

Ray Sullivan, a retired National Park Ranger, was hit 7 times by lightning. He has been knocked down, picked up and thrown into the air. He has lost his shoes and a toenail, and he can't hear as well, but at least he's still alive.

Now he lives in a mobile home with lightning rods on each end and lightning rods on trees around his home. Hopefully, lightning will follow the rods and leave Ray alone.

BOOM!

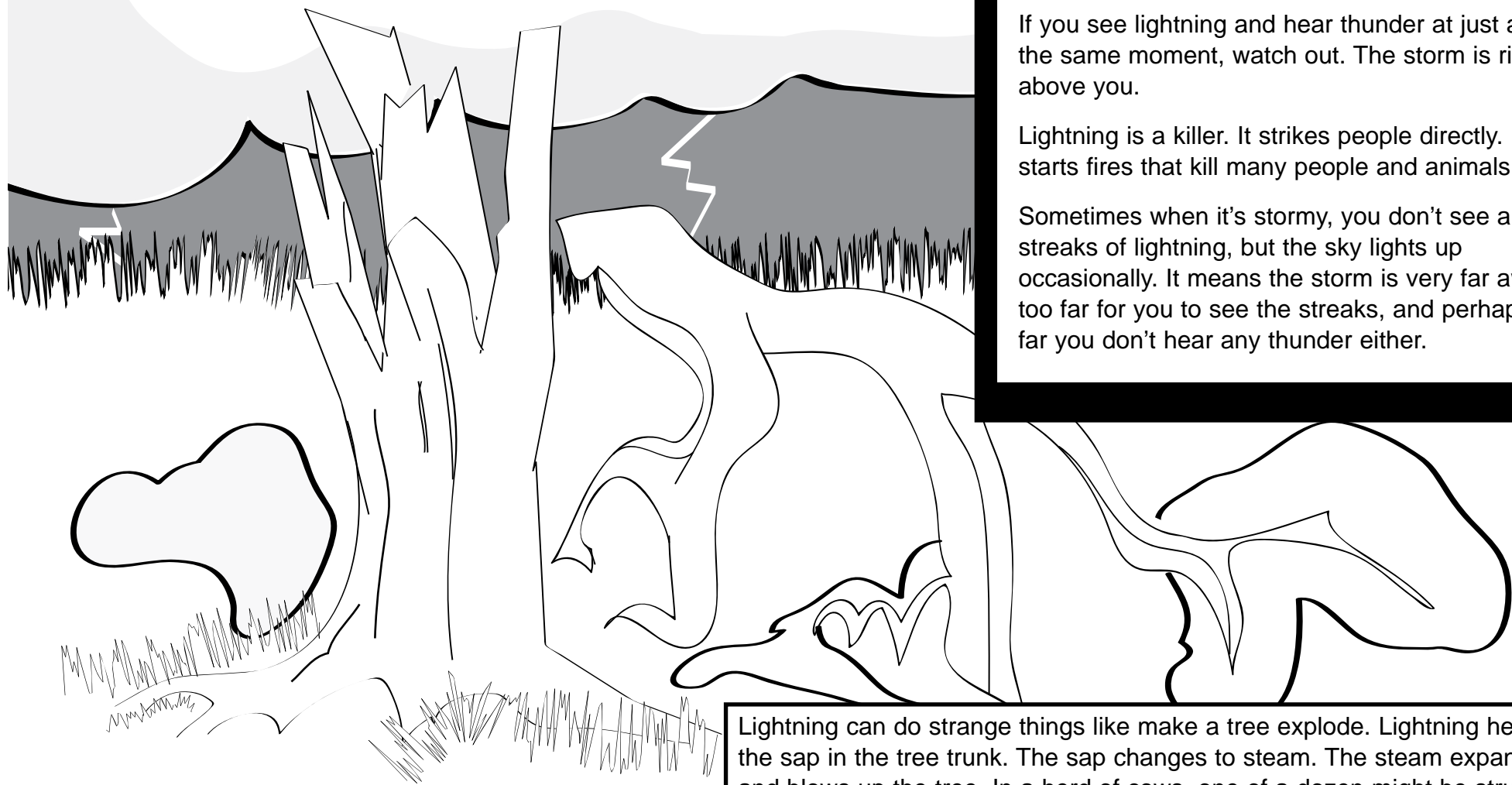

Thunder and lightning occur at the same time. It just seems like you see the lightning first because light moves faster than sound.

As soon as you see lightning, count the seconds until you hear the thunder. If you count 5 seconds, the lightning was about a mile away. Sound goes about 1000 feet a second. In the metric system, if you count three seconds to hear thunder, the storm is about a kilometer away.

If you see lightning and hear thunder at just about the same moment, watch out. The storm is right above you.

Lightning is a killer. It strikes people directly. It also starts fires that kill many people and animals.

Sometimes when it's stormy, you don't see any streaks of lightning, but the sky lights up occasionally. It means the storm is very far away, too far for you to see the streaks, and perhaps so far you don't hear any thunder either.

Lightning can do strange things like make a tree explode. Lightning heats the sap in the tree trunk. The sap changes to steam. The steam expands and blows up the tree. In a herd of cows, one of a dozen might be struck. The others may be untouched. Lightning can also kill a whole herd.

What To Do When There is Lightning

- Get into your home or a large building.
- Get inside a hard-topped car.
- If you are in a field, crouch on your knees and bend over. Don't lie down because wet ground can carry electricity.
- If you are in water, get out. Get away from the beach.

If You are Outside

- If outside, stay in the open, not under a tree or in a picnic shelter or shed. It's better to get wet than fried!
- Lightning hits the tallest object.
- Move away from anything made of metal like a framed backpack. Metal draws electricity.
- Get to the lowest point possible if you are on a hill or mountain.
- Get out of a boat and into a building.

If You're Inside

A line drawing of a room illustrating lightning safety instructions. The room contains a desk with a computer monitor and keyboard, a sink with a faucet, and a telephone on a table. There are windows in the background showing a stormy sky with lightning. Four callout boxes provide specific instructions: 'Keep away from windows and doors. Flying glass could hurt you.' (pointing to a window), 'Turn off the TV and computer. Don't use the microwave or other electric appliance. Lightning could follow the wire, hurt you, and wipe out the appliance.' (pointing to the computer), 'Stay away from sinks and tubs and anything else wet that could conduct electricity.' (pointing to the sink), and 'Don't use the telephone unless there's an emergency.' (pointing to the telephone).

Keep away from windows and doors. Flying glass could hurt you.

Turn off the TV and computer. Don't use the microwave or other electric appliance. Lightning could follow the wire, hurt you, and wipe out the appliance.

Stay away from sinks and tubs and anything else wet that could conduct electricity.

Don't use the telephone unless there's an emergency.

Floods and Flash Floods

Flash floods are fast moving water that can sweep you or your car away in seconds.



Floods are too much water on normally dry land. Rivers can flood after heavy rain has fallen over a long period of time. River flooding can last weeks or longer. River floods usually occur slowly enough to allow people to move to safety.

Flooding can occur anytime of the year. Some floods are seasonal, when winter or spring rains combine with melting snows and fill rivers with too much water quickly. Other floods are associated with hurricanes and tropical storms in the summer and fall.

Whenever it rains heavily, there may be flash floods. Flash floods occur in mountain streams, canyons or dry washes. They also happen on low spots in cities and suburbs.

Flash floods can occur even though it's not raining where you are. It may be raining so hard upstream that water cannot sink into the ground. Water rushes down to the stream, which fills up past its banks and overflows.

A flash flood may come at you like a high wall of water. To save yourself and your parents, you need a plan.

Flash Flood Warning

When you hear a Flash Flood Warning on the radio or TV, there is flooding right NOW. Get away from low-lying roads and other low spots NOW. Seconds count.

Two feet of moving water is enough to sweep a car or truck away. **Turn Around Don't Drown!**

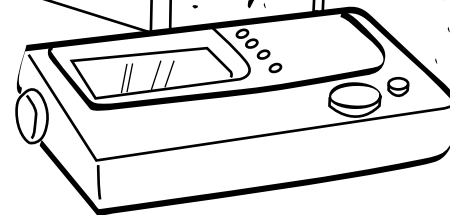
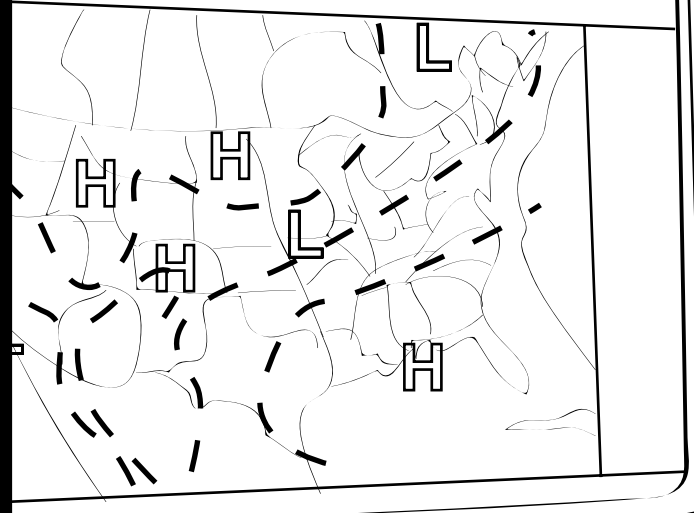

Stay Calm

Move to higher ground—leave everything and run. A flash flood can pick up cars, campers, vans and recreational vehicles and roll them downstream. It can tumble huge boulders, uproot trees and carry them away, wash out roads and tumble bridges like matchsticks.

Campers

- If the weather forecast is for heavy rain, stay home.
- If you already have set up camp, stay alert. Listen to local stations on your battery powered radio.
- Watch for signs of rain—not only where you are but upstream.
- Plan ahead. Pick high ground for your camp. Also know how to get to even higher ground in an emergency. Check your escape route to make sure it's passable.
- Remember, seconds count. Flash floods move with lightning speed!

When You Are Outside

- Keep out of storm drains, irrigation ditches, dry washes or other waterways. When it rains, the water can rush through too fast for you to escape.
- There will probably be lots of lightning. Go to higher ground, but stay off hilltops.
- Don't get under lone trees. Follow lightning safety guidelines.



In a Car or Truck

- Watch for flooding on bridges and low points in the road.
- Stay off bridges or roads under water. All of a sudden the bridge or the road could be washed out. They may not even be there under the water.
- If you are in a car, truck or other vehicle and become washed away by water, get out and swim to higher ground if you can.
- If you're riding in a car at night, be specially careful. If you drive into deep water, get out of your car. Climb to higher ground.
- If you're driving through canyon country along a stream and hear a Flash Flood Warning, leave your car and climb to higher ground. Don't try to outrun the flash flood.

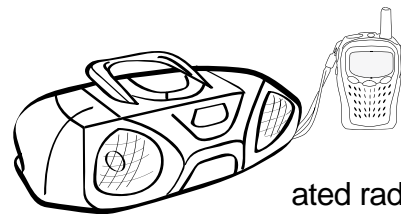

In areas with frequent flash floods, keep a battery operated radio with you. Tune to a local station or stay tuned to NOAA Weather Radio. The flood may get worse. Keep away from streams and rivers.

Winter Storms



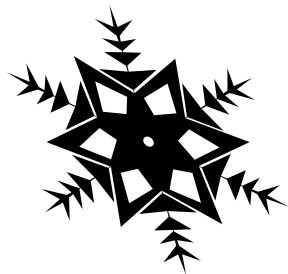

Flash floods and tornadoes can occur any month of the year. Not so with snow storms, which occur in winter or sometimes in early spring or late fall. Usually the snow piles up slowly, so you have time to get to a safe place, but not always. In a winter storm, a few flakes may fall and the next moment you see blinding snow. It's so heavy you can't see to drive or walk. It piles up deeper and deeper. All at once you may be stalled in a huge drift. You may be trapped.

Winter Storm **Watch**

There is a chance of heavy snow, ice or sleet, ice storm, dangerously low wind chill or a blizzard within the next 3-4 days.

Winter Storm **Warning**

Severe winter weather has begun or is almost definitely coming in 24 hours. Be alert. Stay indoors!

Car Safety Kit:

Tell your parents to put these things in the trunk if you live somewhere that gets deep snow even occasionally:

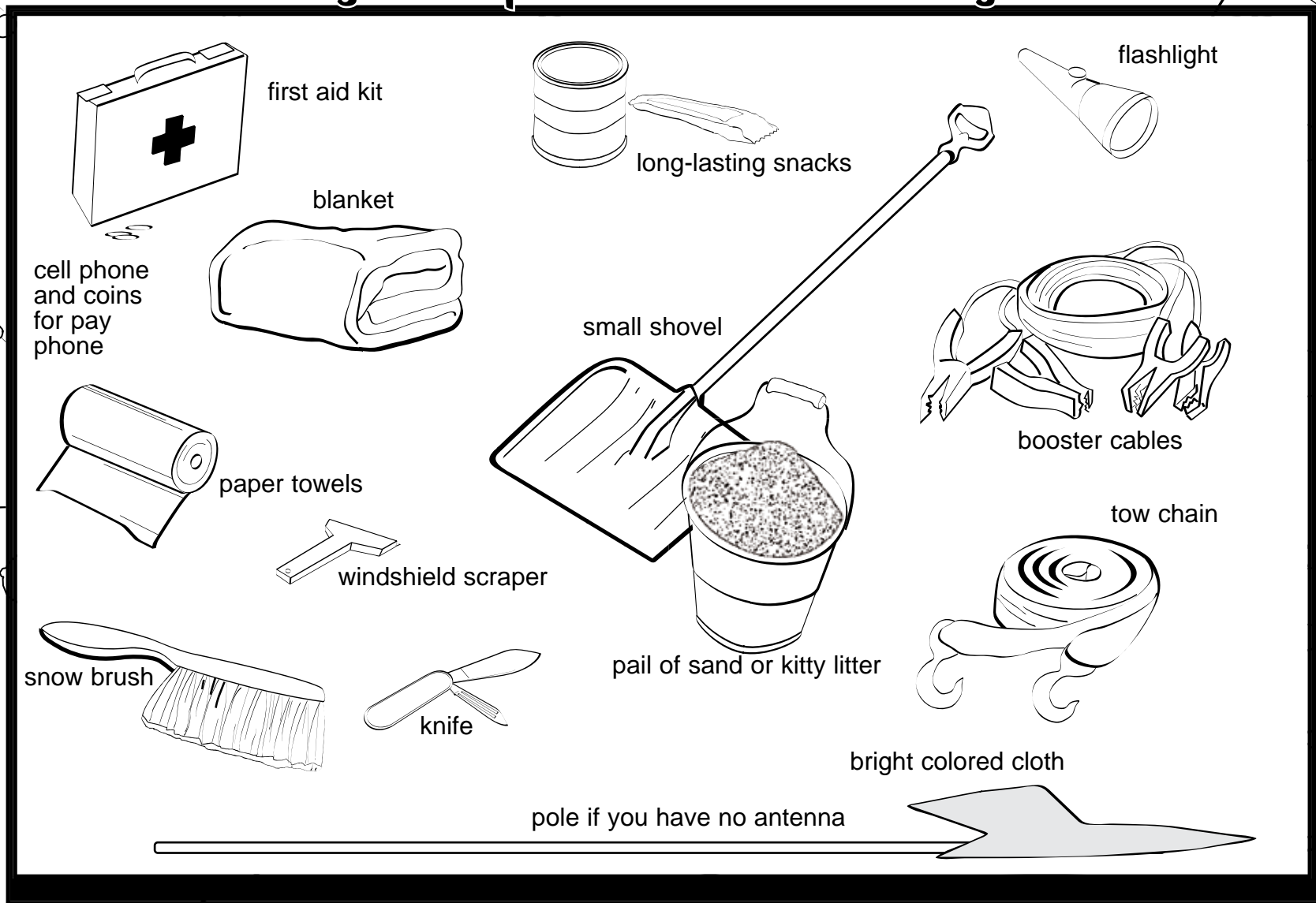

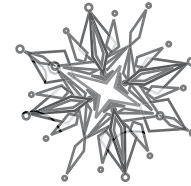

If Your Car Gets Stuck

- Tie a bright cloth to the antenna and raise it high so rescuers can find you.
- If your car has no antenna, use a pole or fishing rod.
- As you sit, exercise. Clap your hands, stomp your feet, swing your arms about. Keep your blood moving to keep warm. Don't leave the car.
- Run the car engine for 10 minutes every hour, keep windows opened a little bit to prevent carbon monoxide poisoning. Conserve gasoline and food. You may be stranded for a long time.
- Leave the ceiling light on at night so you can be seen.

42

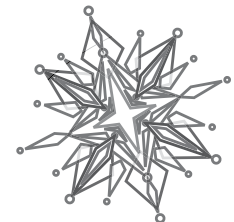
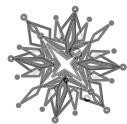

25

What To Do If You're at Home

Electricity may go off. Have a way to cook and keep warm.
The furnace may not work.

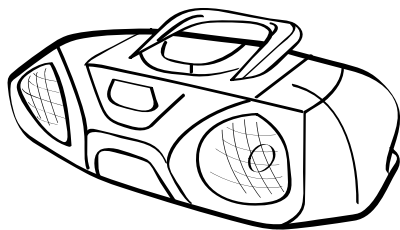

Find your battery operated radio and spare batteries.

Have a supply of water, food and a flashlight.

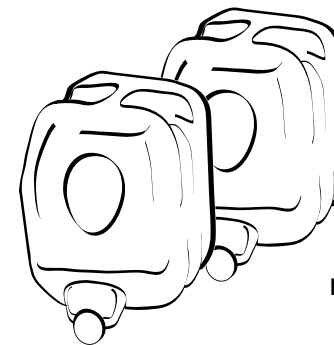
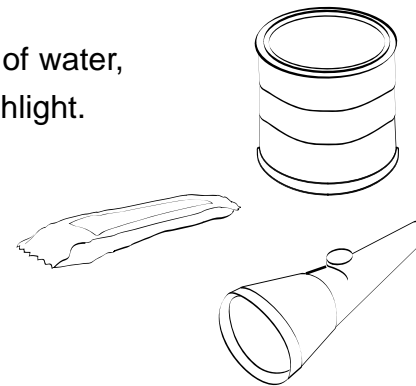

Save and clean three large drink bottles or a large water container for each family member.



If you must go out in a blizzard...

- Wear mittens. They are warmer than gloves.
- Wear several layers of wool clothing and a windbreaker. Layers are warmer than a single heavy garment.
- Wear a hood that covers your mouth.
- Wear a hat and ear muffs.
- If you must go out, fasten a lifeline to yourself and to the house so you don't get lost in the blizzard.

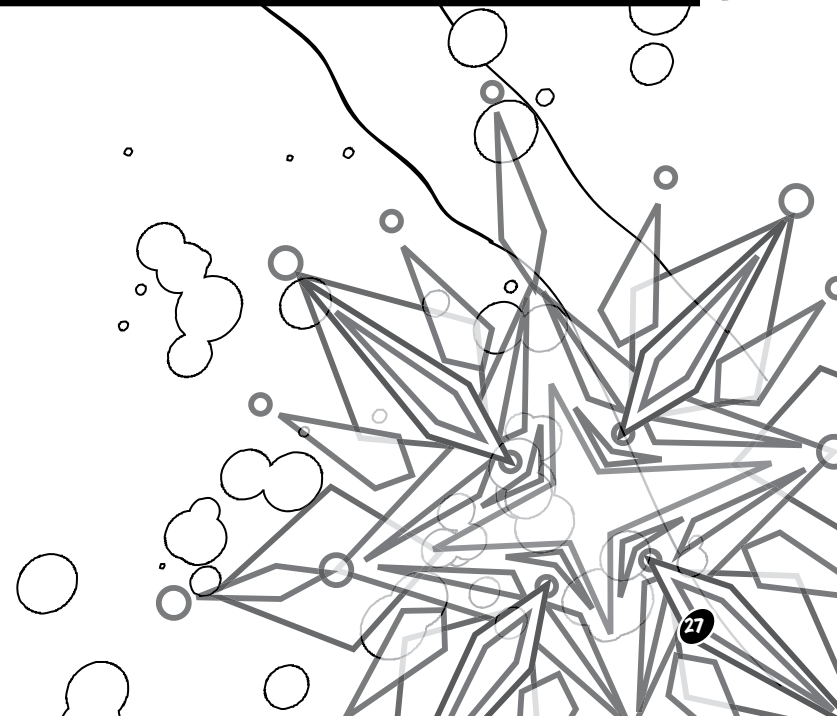

Owlie's Snow How



In the Antarctic, there is a 30-30-30 rule. When the temperature is 30 below, and the wind is 30 miles per hour, a person can live only 30 minutes outside.

During the winter, you often hear the term "wind chill." Wind combined with cold air makes your body feel even colder than the actual temperature. You get that feeling when you get out of the pool or ocean in the summer.

In winter, wind chill can be dangerous. For example when the outside temperature is zero degrees and the wind speed is 20 miles per hour, the wind chill makes it feel like 22 degrees below zero. Exposed skin will freeze in less than 30 minutes.

Did You Know?

- The lowest temperature in the United States was -79.8°F (-62.1°C) at Prospect Creek Camp in the Endicott Mountains of northern Alaska on January 23, 1971.
- Outside from Alaska, the coldest U.S. temperature was -69.7°F (56.5°C) in Rogers Pass, Montana, January 20, 1954.
- One storm, from February 13-19, 1959, dumped 189 inches of snow at Mt. Shasta Ski Bowl, California.
- The greatest snowfall in 24 hours in the United States was at Silver Lake, Colorado, on April 14-15, 1921: 75.8 inches.
- The most snow in the United States in one month—390 inches (32.5 feet) fell at Tamarack, California, in January 1911.
- In the winter of 1971-72, 93.5 feet (1,122 inches) of snow fell at the Rainier Paradise Ranger Station in the state of Washington.

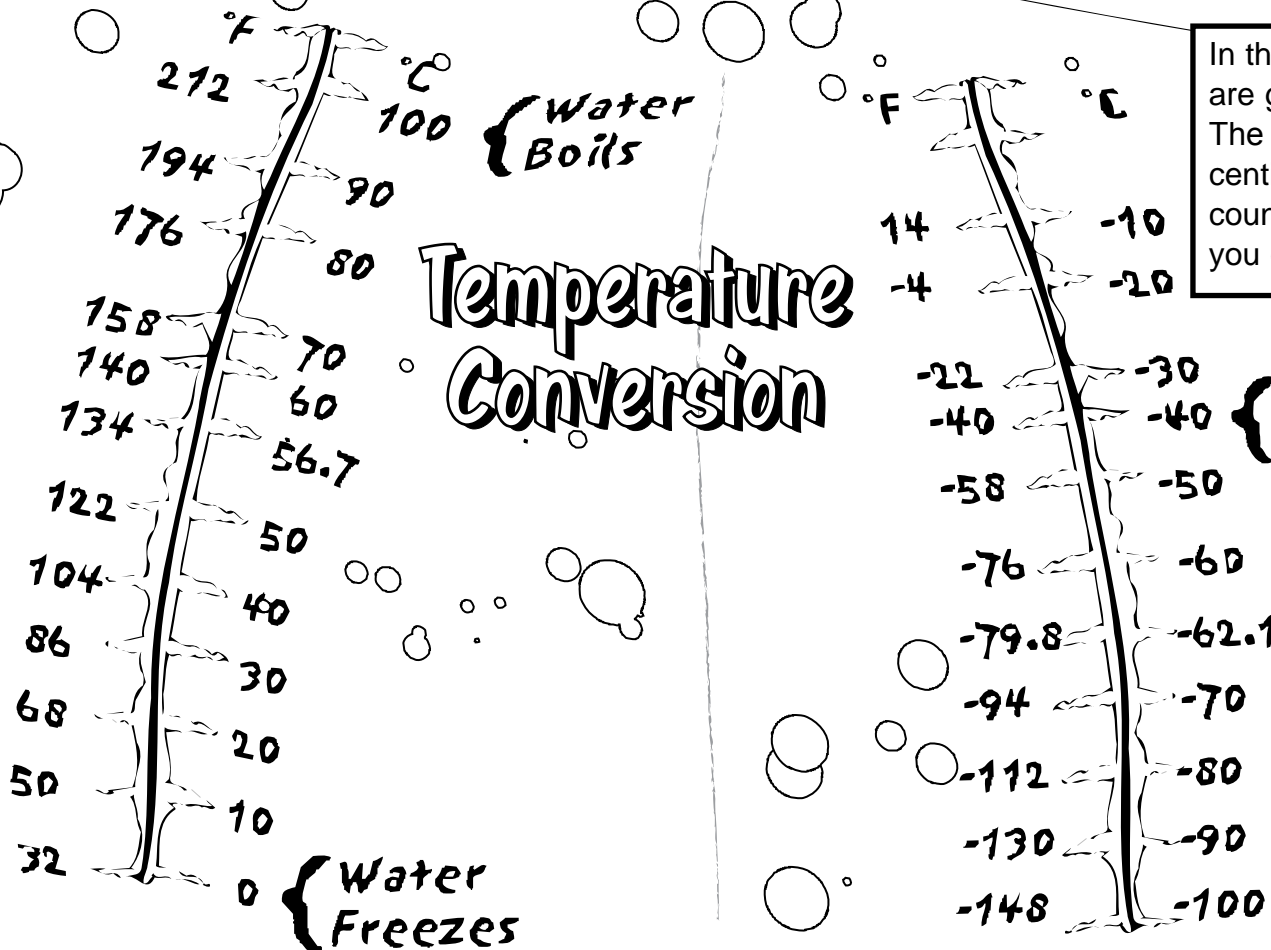

In the United States, temperatures are given in Fahrenheit degrees. The Celsius temperatures (also called centigrade) are used in most other countries. Here are both scales so you can convert one to another.

Lightning Quiz

Circle T (True) or F (False) for each sentence below.

- T F 1. When there is lightning, crouch under a tree.
T F 2. When there is lightning, stay away from anything made of metal.
T F 3. Stay by the window and watch for streaks of lightning.
T F 4. In a storm, you usually see the lightning before you hear the thunder.
T F 5. When the sky lights up, but you can't see the streaks of lightning, it means the storm is over.
T F 6. When there is lightning, go to the highest spot on a hill and get out your umbrella for protection from the storm.
T F 7. Every day someone is struck by lightning.
T F 8. Lightning never strikes twice in the same place.
T F 9. If there is lightning, call all your friends to make sure they are safe.
T F 10. Lightning storms may occur in the winter but are most common in spring and summer.

Fill in the blank with the correct words.
Use these words:

die fire electricity explode
shortest water tree tallest
thunder corded telephone

1. About 55 people ____ each year from lightning and the fires it causes.
2. Don't use a _____ unless there is an emergency.
3. _____ and lightning occur together.
4. Lightning can make a tree _____ by heating the sap in the tree.
5. Lightning hits the _____ objects.
6. Lightning takes the _____ path.
7. When lightning forms, clouds become charged with _____.
8. If you are outside when there is lightning, don't go under a _____.
9. When lightning strikes, it can start a _____ that kills people and animals.
10. If you are in _____ get out. Stay away from the beach.

Answers on page 46

List 5 rules for lightning safety.

1. _____
2. _____
3. _____
4. _____
5. _____



Winter Storm Quiz

Fill in the blank with the correct words. Use these words:

winter	antenna	snowdrift	carbon monoxide
Watch	mittens	Warning	layers
kitty litter	wind chill		

1. A Winter Storm _____ means there is a chance of heavy snow or blizzards.
2. A Winter Storm _____ means severe winter weather is coming.
3. If a winter storm is expected you should have sand or _____, _____ in your trunk in case your car gets stuck.
4. If a winter storm is expected, you should put a bright colored cloth on the _____ so someone can find you.
5. If you keep your car engine running to keep warm, you could die from _____ poisoning unless your windows are open to get fresh air.
6. If you go outside in severe weather, you will be warmer if you wear _____ of wool clothing.
7. _____ are warmer than gloves.
8. Snow storms and blizzards usually occur in _____.
9. The temperature your body feels when the actual temperature and wind are combined is called _____.
10. If you are driving during a blizzard, your car could be stalled in a huge _____.

Answers on page 46

Make a list of supplies you should keep in your car to prepare for winter storms or blizzards.

Circle T (True) or F (False) for each sentence below.

- T F 1. During a winter storm, you can be stuck in a snowdrift.
- T F 2. If your car is stuck in the snow, roll up all the windows and keep the engine running until you run out of gas.
- T F 3. If you are trapped in a car, move your hands and feet as much as possible to keep warm.
- T F 4. An umbrella should be a part of your winter storm safety kit.
- T F 5. Snow storms can occur anytime of the year.
- T F 6. If your car is stuck in the snow, leave your ceiling light on at night so you can be seen.
- T F 7. Booster cables and a snow brush should be part of your winter storm car safety kit.
- T F 8. Wind chill is the combined effect of temperature and wind felt by your body.
- T F 9. Wear gloves. They are warmer than mittens.
- T F 10. If your car is stuck in a snowdrift, stand on the roof wearing brightly colored mittens and wave your arms.

Tornado Quiz

On the lines to the left, tell what you should do if a tornado is coming.

Circle T (True) or F (False) for each sentence below.

- T F 1. A tornado looks like a funnel with the fat part at the top.
- T F 2. You will always notice a funnel before a tornado strikes.
- T F 3. A tornado destroys everything in its path.
- T F 4. A tornado may hit your home and leave your neighbor's home alone.
- T F 5. A strong tornado can throw cars and trucks into the air.
- T F 6. There will seldom be lightning during a tornado.
- T F 7. Go into a large room such as the school cafeteria if there is a tornado warning.
- T F 8. The sky may be clear at the time you hear a Tornado Watch.
- T F 9. When a tornado is coming, get out of a car or truck and go in a house.
- T F 10. If you live in a mobile home or trailer, you are safe staying there during a tornado.

Fill in the blank with the correct word. Use these words:

funnel	radio	ditch	train
windows	bathroom	Watch	sky
Warning	hail	mobile home	tornado
black clouds	basement	top	

1. A _____ can flatten homes and buildings.
2. A tornado looks like a _____ with the fat part at the _____.
3. Before a tornado, you will probably see _____ and _____.
4. A Tornado _____ is issued by the National Weather Service when a tornado may develop later.
5. A Tornado _____ is issued by the National Weather Service when a tornado has actually been seen.
6. A tornado can sound like the roar of a _____.
7. If you are outside when you see a tornado, go to a low spot or a _____.
8. The best place to be if there is a tornado is in a _____.
9. There may be thunder, lightning, rain or _____ along with the tornado.
10. If you don't have a basement, the next best place to be is in a _____ or other small room in the center of the house.
11. Stay away from _____ during a tornado.
12. If you live in a _____ _____, get out. It can be shattered by a tornado.
13. When you hear a Tornado Watch, keep your eyes on the _____.
14. You can hear a Tornado Watch by listening to NOAA Weather _____.

Flash Flood Quiz

Fill in the blank with the correct word. Use these words:

streams

ground

flash flood

roads

bridges

car or truck

1. A flash flood can wash out _____ and bridges.
2. A _____ may come to you as a high wave of water.
3. If it is raining hard, water cannot sink into the _____.
4. Flash floods most often occur in mountain _____.
5. If you are driving in deep water, get out of your _____ and climb to higher ground.
6. If you are driving in heavy rain, watch for flooding at _____ and low points in the road.



Circle T (True) or F (False) for each sentence below.

- T F 1. When you hear a Flash Flood Warning it means there will be a flood within 24 hours.
- T F 2. Flash floods usually occur along beaches.
- T F 3. If you are camping and a flash flood occurs, run to higher ground.
- T F 4. Along with flash floods, there is often heavy lightning.
- T F 5. Drive as fast as possible through a flooded road to avoid being washed downstream.
- T F 6. Never try to outrun a flash flood.
- T F 7. If you are camping and you hear a flash flood warning, pack up your tent and bring all your camping gear so it will not be damaged by the flood.
- T F 8. A flash flood can wash out roads and bridges and uproot trees.
- T F 9. The National Weather Service will always warn you if a flash flood is expected.
- T F 10. Whenever it rains heavily, there may be flash floods.

Answers on page 46

What should campers do if heavy rains are expected?

answers on Page 46

Hurricane Quiz

List 3 things you can do to prepare for a hurricane.

Fill in the blank with the correct words. Use these words:

Watch	eye	radio	flooding
hurricanes	moving	Warning	air
inland	storm surge	oceans	

1. The _____ that surrounds our planet weighs five quadrillion tons.
2. Air is _____ all the time. It swirls, blows, sinks and rises.
3. Air moves over warm _____ and picks up lots of moisture.
4. In summer and early fall, _____ form when air masses pick up lots of moisture.
5. Hurricanes cause _____ and _____.
6. A hurricane _____ tells people a hurricane may reach land within 2 days.
7. A hurricane _____ means a hurricane is expected within 36 hours and winds could reach 74 mph or more.
8. NOAA Weather _____ warns people about hurricanes.
9. If you live near the ocean, go _____ where it is safe.
10. The center of a hurricane is called the _____.

Answers on page 46

Circle T (True) or F (False) for each sentence below.

- T F 1. High wind is called a storm surge.
T F 2. NOAA Weather Radio stations warn people about hurricanes.
T F 3. Hurricanes usually appear suddenly and surprise everyone.
T F 4. When a hurricane is expected to reach land in 2 days, forecasters issue a Hurricane Warning.
T F 5. Hurricane Hunter airplanes fly into a storm to get information about the hurricane.
T F 6. Hurricane winds can reach 350 mph.
T F 7. Hurricanes cause rain, high tides and flooding.
T F 8. During a hurricane, stay under a tree.
T F 9. Put duct tape on your windows if a hurricane is coming.
T F 10. It is a good idea to have a flash light, radio and extra batteries if a hurricane is expected.



Weather Hazards

Fill in each space with the correct weather hazard:

hurricane, tornado, lightning, flash flood or winter storm.

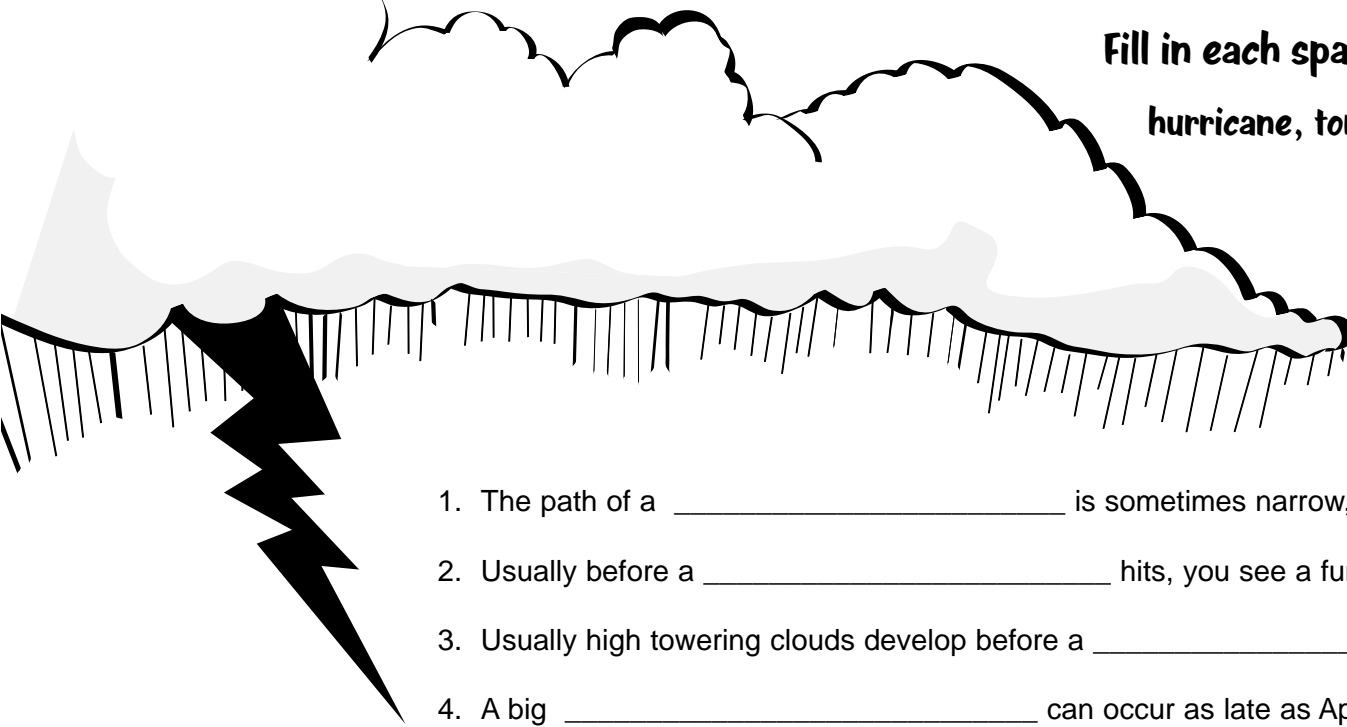

1. The path of a _____ is sometimes narrow, but very destructive.
2. Usually before a _____ hits, you see a funnel extending from a dark cloud formation.
3. Usually high towering clouds develop before a _____ storm.
4. A big _____ can occur as late as April, which happened in 1982.
5. A _____ usually occurs in valleys where there are narrow stream beds.
6. A _____ is a huge storm that usually develops in August or September.
7. In a _____ the most dangerous hazard may be flooding.
8. When a _____ approaches, go to the basement or to an inside closet or hall.
9. When a _____ approaches, get away from the seashore. Go to a safe inland location.
10. Don't try to outrun a _____ in your car.

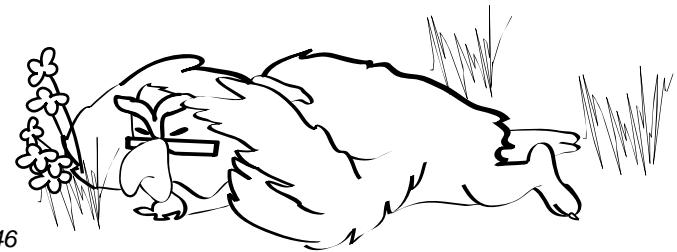

Answers on page 46

How should you prepare for bad weather? See how much you have learned!



For each clue below, write down what kind of weather you should prepare for: tornado, hurricane, winterstorm, lightning, floods or all of these weather hazards.

1. Go to the lowest level _____
2. Put boards over windows _____
3. Stay away from windows _____
4. Stay in your car _____
5. Get out of your car _____
6. Stay away from metal _____
7. Stay indoors _____
8. Have fresh water _____
9. Have a NOAA Weather Radio or battery powered radio _____
10. Cover your head with your hands _____

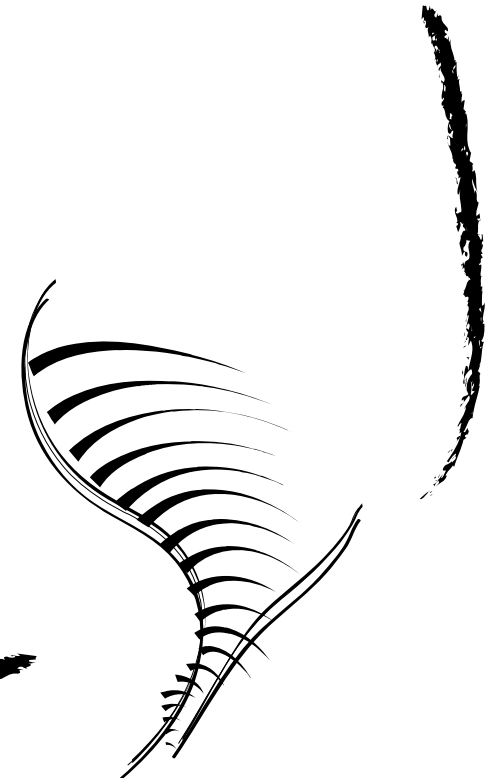
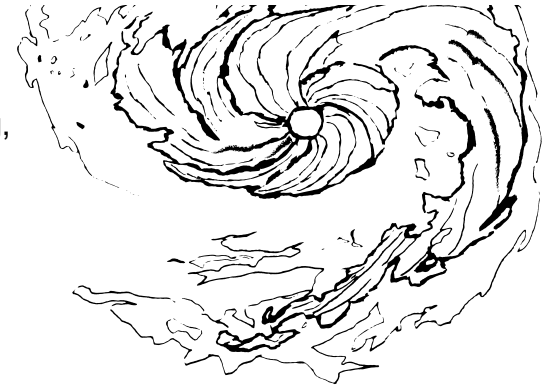

Answers on page 46

True or False? Weather and Warnings

Try these true or false questions.

10 right—You're a weather wizard

8 right—You're okay

6 or less right—Read this booklet again. It may save your life and your family's lives.



- T F 1. Tornadoes kill more people than any other kind of storm.
- T F 2. Hurricanes are very large storm systems.
- T F 3. Wind is the main cause of loss of life in a hurricane.
- T F 4. Lightning never strikes twice in the same place.
- T F 5. Tornadoes occur only in Midwestern states.
- T F 6. Flash floods occur only when it's raining where you are.
- T F 7. In a tornado, the winds may swirl 200-300 miles an hour.
- T F 8. Winter storms develop after several hours of winds and clouds warning you of danger.
- T F 9. A safe place to be during a lightning storm is inside a hard top car, van or truck.
- T F 10. During a lightning storm, get under a large tree for protection.

Tornado watch in effect until 9:00 p.m.

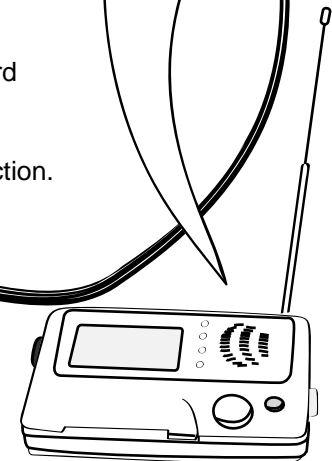

Answers on page 46

Fill in each space with one of the answers below. Then fill in the crossword puzzle on the next page to check your answers.

Answers: Electricity, eye, floods, forecasts, funnel, hail, hurricane, lightning, radio, shortest, snowstorms, summer, surge, thunder, tornado, warning, weather, or wind chill.

Down

1. During a severe storm watch TV or listen to your local _____, it can help save lives.
2. Before the storm comes get a flashlight and _____ with batteries in case you lose electricity.
3. The calm section of a hurricane is called the _____.
5. A _____ packs a lot of energy, enough to blow down a whole town.
7. _____ occur in winter and sometimes in early spring or late fall.
9. _____ kills more people than hurricanes and tornadoes.
10. Water 25 feet above normal high tide in a hurricane is called a storm _____.
11. Lightning takes the _____ path.
12. If you hear a tornado _____ act immediately.
13. A _____ is a big doughnut of winds with a calm section in the middle.

Across

4. Stay away from sinks and tubs and anything else wet that could conduct _____.
6. _____ measures how cold you and your pet feel on cold, windy days.
7. Lightning storms may occur in the winter but are most common in the spring and _____.
8. Flash _____ can occur even though it's not raining where you are.
14. _____ and lightning occur together.
15. More than 1000 NOAA _____ Radio stations broadcast hurricane watches and warnings.
16. Thunderstorms can be accompanied by damaging _____ as large as golf balls or baseballs.
17. A tornado looks like a _____ with the fat part at the top.

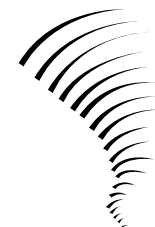
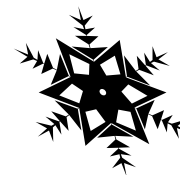

What did you learn? Use the clues on the previous page to fill in this crossword puzzle.

If your answers all fit, congratulations!

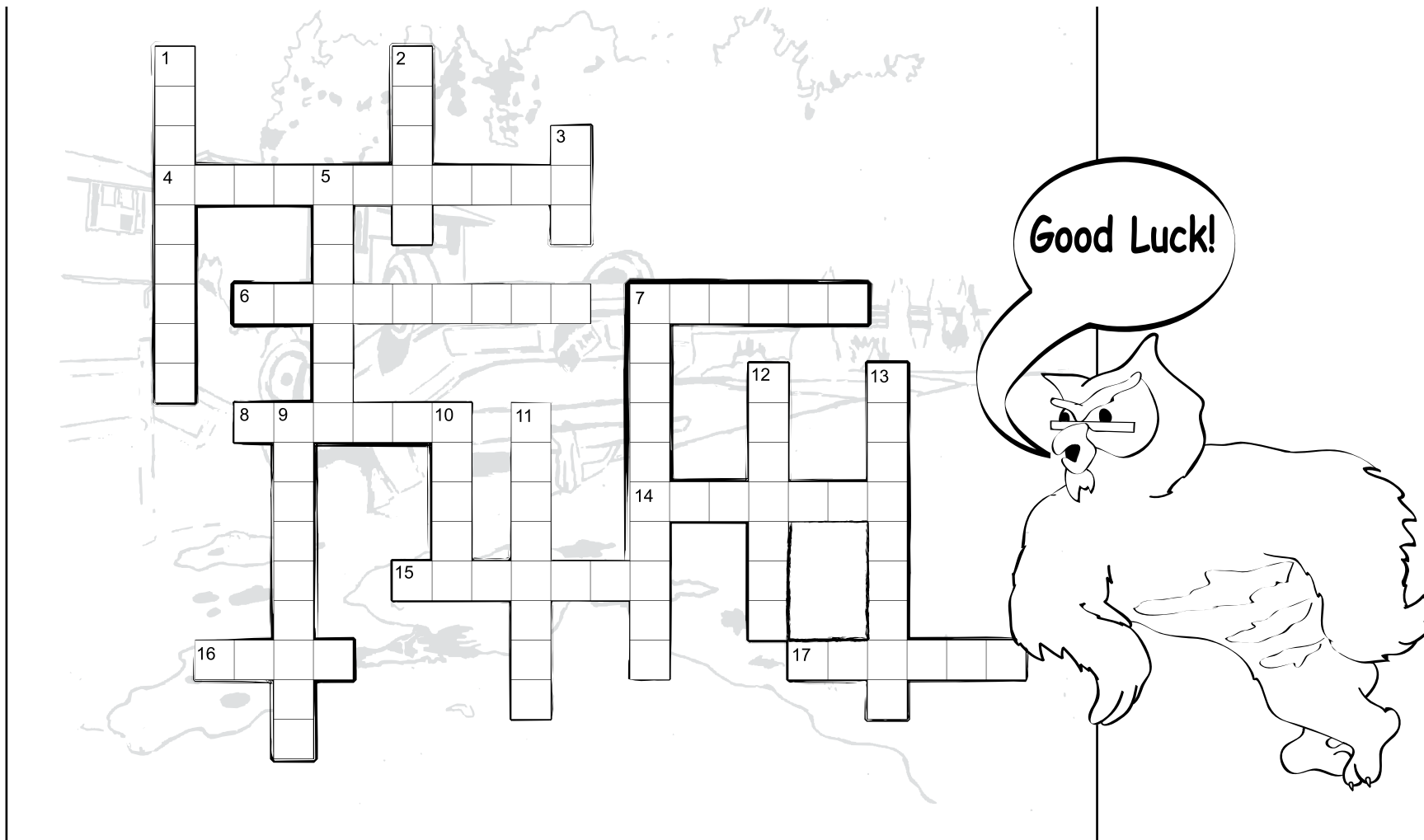

Notes





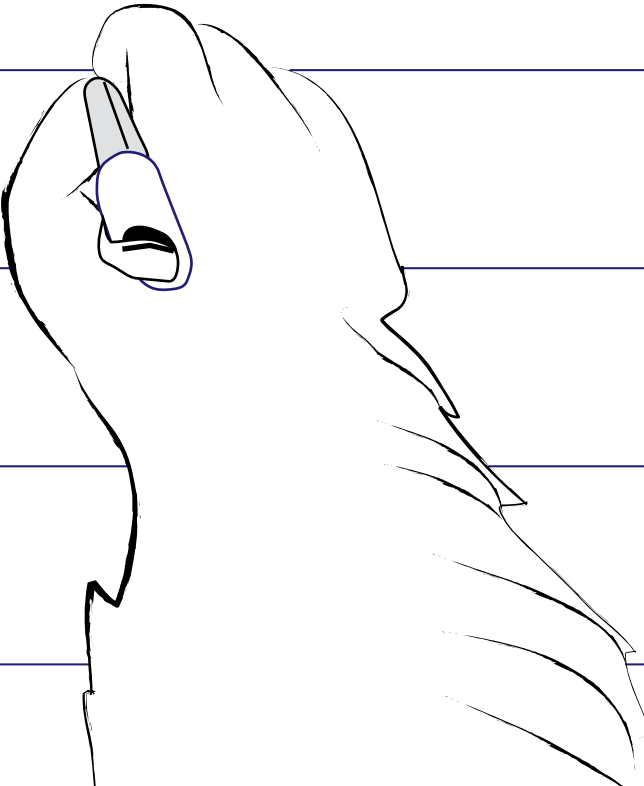





Answers

crossword puzzle (pgs 38-39)

Answers: (Across)

4. electricity, 6. wind chill, 7. summer, 8. floods,
14. thunder, 15. weather, 16. hail, 17. funnel

Answers: (Down)

1. forecasts, 2. radio, 3. eye, 5. tornado,
7. snowstorms, 9. lightning, 10. surge, 11. shortest,
12. warning, 13. hurricane

true & false (pg 37)

1. F-hurricanes, 2. T, 3. F- flooding,
4. F, 5. F-anywhere 6. F, 7. T, 8. F, 9. T,
10. F

fill in the blanks (pg 35)

1. tornado, 2. tornado, 3. lightning,
4. winter storm, 5. flash flood 6. hurricane,
7. hurricane, 8. tornado, 9. hurricane, 10. tornado

tornado quiz (pg 32)

1. tornado, 2. funnel and top, 3. black clouds,
4. watch, 5. warning, 6. train, 7. ditch, 8. basement,
9. hail, 10. bathroom, 11. windows, 12. mobile home,
13. sky, 14. radio -- 1. T, 2. F, 3. T, 4. T, 5. T, 6. F,
7. F, 8. T, 9. T, 10. F

hazards (pg 36)

1. tornado, 2. hurricane, 3. hurricane, lightning and
tornado, 4. winter storm and lightning, 5. flash flood,
6. lightning, 7. hurricane, lightning, winter storm, and
tornado, 8. hurricane, tornado, and winter storm,
9. hurricane, tornado, winter storm and flash flood,
10. tornado

hurricane quiz (pg 34)

1. air, 2. moving, 3. oceans, 4. hurricanes,
5. high tides and flooding, 6. watch,
7. warning, 8. radio, 9. inland, 10. eye --
1. F, 2. T, 3. F, 4. F, 5. T, 6. F, 7. T, 8. F, 9. F, 10. T

flash flood quiz (pg 33)

1. roads, 2. flash flood, 3. ground, 4. streams, 5. car
6. bridges -- 1. T, 2. F, 3. T, 4. T, 5. F, 6. F, 7. F, 8. T,
9. F, 10. T

winter storm quiz (pg 31)

1. watch, 2. warning, 3. kitty litter, 4. antenna,
5. carbon monoxide, 6. layers, 7. mittens,
8. winter, 9. wind chill, 10. snowdrift -- 1. T, 2. F,
3. T, 4. F, 5. F, 6. T, 7. T, 8. T, 9. F, 10. F

lightning quiz (pg 30)

1. die, 2. telephone, 3. thunder, 4. explode,
5. tallest, 6. shortest, 7. electricity, 8. tree,
9. fire, 10. water -- 1. F, 2. T, 3. F, 4. T, 5. F, 6. F,
7. T, 8. F, 9. F, 10. T

Resources

Web Weather for Kids: Check this out if you want to make fog, a tornado, or lightning. http://www.ucar.edu/educ_outreach/webweather/

Kids Crossing: Wow! Explore this weather funhouse. Lots of weather links too. <http://eo.ucar.edu/kids/>

Weather, Seasons and Climate: Play the weather game, keep a weather journal or color the seasons. <http://www.cotf.edu/ete/modules/k4/teacher/weather/weather.html>

Jetstream: Want to learn more? Check out our online weather school. <http://www.srh.noaa.gov/jetstream/>

Playtime for Kids: The place to find coloring books, puzzles, games and other fun stuff. <http://www.nws.noaa.gov/om/reachout/kidspage.shtml>

Kid's Hazards Quiz: Are you prepared? Find out by taking this fun quiz. <http://www.ngdc.noaa.gov/hazard/kqStart.shtml>

SciJinks Weather Laboratory: Write your own weather story or find a weather science fair topic. <http://scijinks.nasa.gov/>

Franklin's Forecast: Learn how to make your own weather station; learn about El Nino and radar. <http://www.fi.edu/weather/>

Web Weather for Kids: Games, activities and fun facts. <http://eo.ucar.edu/webweather/>

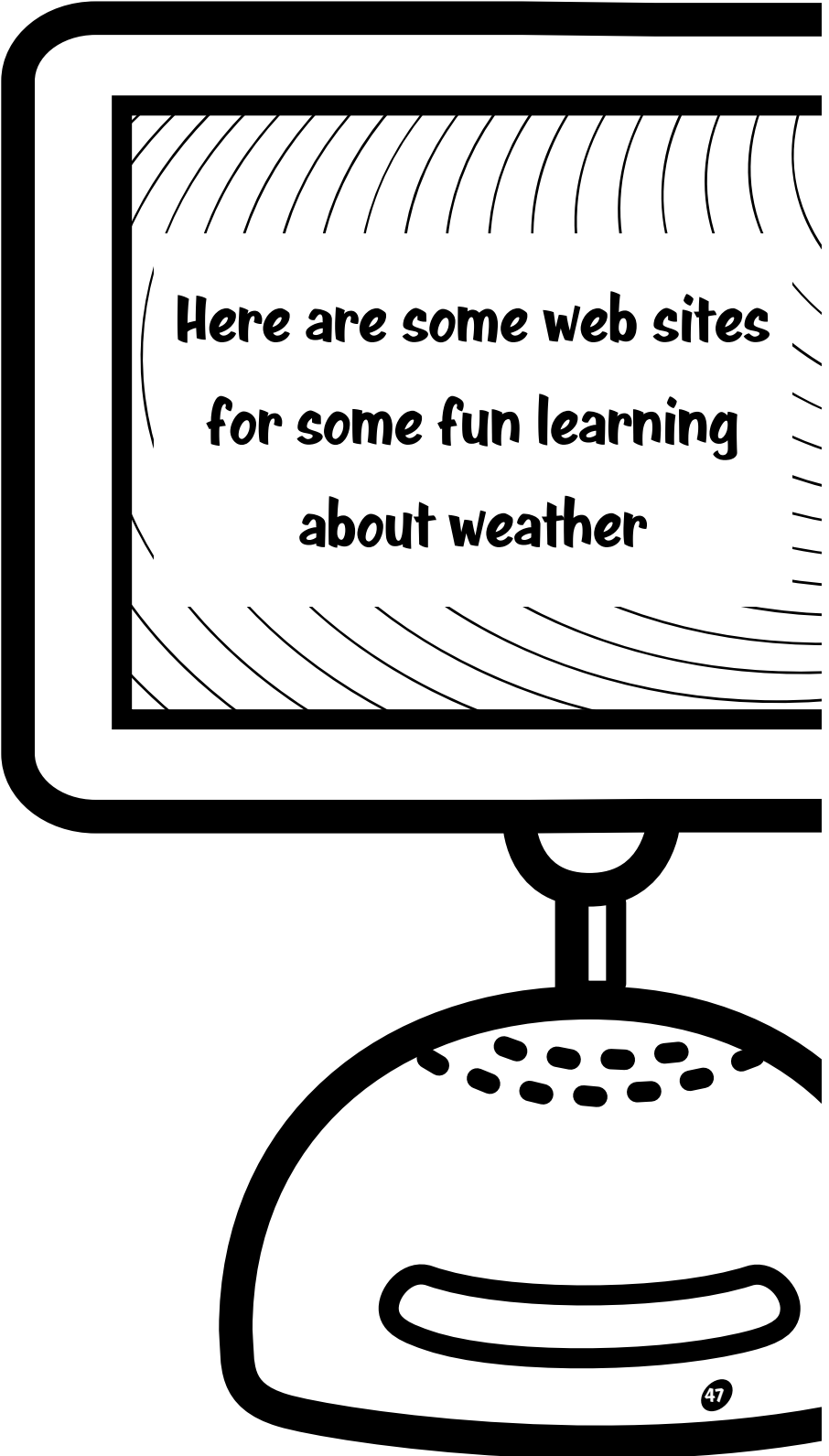

**Here are some web sites
for some fun learning
about weather**

My Owlie Skywarn's Weather Book

Name _____

School _____



FEMA



American
Red Cross



FEMA

