



ALASKA DEPARTMENT OF TRANSPORTATION

Evaluation of the FHWA's Sign Management and RetroReflectivity Tracking System (SMARTS) Van

Prepared by: Kurt Smith, AKDOT&PF and
Al Fletcher, FHWA Alaska Division

July, 2001

Prepared for:
Alaska Department of Transportation
Statewide Research Office
3132 Channel Drive
Juneau, AK 99801-7898

FHWA-AK-RD-01-01

Alaska Department of Transportation & Public Facilities
Research & Technology Transfer

REPORT DOCUMENTATION PAGE

Form approved OMB No.

Public reporting for this collection of information is estimated to average 1 hour per response, including the time for reviewing instructions, searching existing data sources, gathering and maintaining the data needed, and completing and reviewing the collection of information. Send comments regarding this burden estimate or any other aspect of this collection of information, including suggestion for reducing this burden to Washington Headquarters Services, Directorate for Information Operations and Reports, 1215 Jefferson Davis Highway, Suite 1204, Arlington, VA 22202-4302, and to the Office of Management and Budget, Paperwork Reduction Project (0704-1833), Washington, DC 20503

1. AGENCY USE ONLY (LEAVE BLANK)

2. REPORT DATE

3. REPORT TYPE AND DATES COVERED

July, 2001

Final, May 2001 – July 2001

4. TITLE AND SUBTITLE

Evaluation of the FHWA's Sign Management and RetroReflectivity Tracking System (SMARTS) Van

5. FUNDING NUMBERS

6. AUTHOR(S)

Kurt Smith and Al Fletcher

7. PERFORMING ORGANIZATION NAME(S) AND ADDRESS(ES)

Alaska DOT&PF
Research and Technology Transfer
3132 Channel Drive
Juneau, AK 99801-7898

8. PERFORMING ORGANIZATION REPORT NUMBER

FHWA-AK-RD-01-01

9. SPONSORING/MONITORING AGENCY NAME(S) AND ADDRESS(ES)

State of Alaska, Alaska Dept. of Transportation and Public Facilities
Research and Technology Transfer
2301 Peger Rd
Fairbanks, AK 99709-5399

10. SPONSORING/MONITORING AGENCY REPORT NUMBER

FHWA-AK-RD-01-01

11. SUPPLEMENTARY NOTES

Performed in cooperation with with the U.S. Department of Transportation, Federal Highway Administration.

12a. DISTRIBUTION / AVAILABILITY STATEMENT

No restrictions

12b. DISTRIBUTION CODE

13. ABSTRACT (Maximum 200 words)

This report documents a performance evaluation of the Federal Highway Administration's Sign Management And Retroreflectivity Tracking System (SMARTS) van. The van's purpose is to photograph, record the location, and measure the retroreflectivity of traffic signs while traveling at highway speeds.

Alaska needs a cost-effective method of inventorying signs and measuring their reflectivity to manage its \$20+ million investment in signs, to know what signs are missing or illegible, and to analyze its compliance with impending national standards for sign retroreflectivity.

Testing consisted of evaluating signs with the van on one rural and one urban road segment, evaluating signs on the rural road segment with a handheld sign retroreflectivity meter, and analyzing the results.

The report concludes that the van's performance was not acceptable. Multiple readings on individual signs varied widely from one run to the next, the percentage of signs captured by the operators on a single pass was unacceptably low, and van readings did not correlate with those of a handheld meter (handheld meters are considered the most accurate measuring device).

14. KEYWORDS : Retroreflectivity, Retroreflection, Retroreflectors, Sign Sheeting, Materials Management

15. NUMBER OF PAGES

54

16. PRICE CODE

N/A

17. SECURITY CLASSIFICATION OF REPORT

Unclassified

18. SECURITY CLASSIFICATION OF THIS PAGE

Unclassified

19. SECURITY CLASSIFICATION OF ABSTRACT

Unclassified

20. LIMITATION OF ABSTRACT

N/A

***Evaluation of the FHWA's
Sign Management and RetroReflectivity
Tracking System (SMARTS) Van***



Report # FHWA-AK-RD-01-01

July, 2001

***Evaluation of the FHWA's
Sign Management and RetroReflectivity
Tracking System (SMARTS) Van***

FINAL REPORT

Prepared for the
Alaska Department of Transportation
& Public Facilities

Authors
Kurt Smith, ADOT&PF State Traffic Engineer
Al Fletcher, FHWA Safety / Operation Engineer

Report # FHWA-AK-RD-01-01
July, 2001

Table of Contents

Acknowledgements	ii
Abstract.....	iii
CHAPTER 1 - INTRODUCTION AND RESEARCH APPROACH.....	1
Problem Statement and Research Objective	1
Scope of Study	1
Research Approach	2
CHAPTER 2 - FINDINGS	3
SMARTS Van Operation	3
SMARTS Van Performance	3
CHAPTER 3 - INTERPRETATION, APPRAISAL, AND APPLICATIONS....	5
General Recommendations	5
CHAPTER 4 - CONCLUSIONS	6
APPENDIX A – SMARTS Van Background Information	A
APPENDIX B – SMARTS Van RetroReflectivity Performance Data	B
APPENDIX C – SMARTS Van GPS Performance Data	C
APPENDIX D – SMARTS Van Operation Manual	D
APPENDIX E – Handheld Meter Manual.....	E

Acknowledgements

The ADOT&PF Research Section funded this report. Al Fletcher, FHWA Safety / Operations Engineer, handled the logistics and brought the van to Alaska from Denver. He and Kurt Smith, ADOT&PF State Traffic Engineer, ran the tests, did the analysis, and wrote the report. Clint Adler was the Research Section contact for the project.

The van and its equipment were supplied by the Federal Highway Administration. It is one of four such vans in the country.



Abstract

This report documents a performance evaluation of the Federal Highway Administration's Sign Management And Retroreflectivity Tracking System (SMARTS) van. The van's purpose is to photograph, record the location, and measure the retroreflectivity of traffic signs while traveling at highway speeds.

Alaska needs a cost-effective method of inventorying signs and measuring their reflectivity to manage its \$20+ million investment in signs, to know what signs are missing or illegible, and to analyze its compliance with impending national standards for sign retroreflectivity.

Testing consisted of evaluating signs with the van on one rural and one urban road segment, evaluating signs on the rural road segment with a handheld sign retroreflectivity meter, and analyzing the results.

The report concludes that the van's performance was not acceptable. Multiple readings on individual signs varied widely from one run to the next, the percentage of signs captured by the operators on a single pass was unacceptably low, and van readings did not correlate with those of a handheld meter (handheld meters are considered the most accurate measuring device).

CHAPTER 1 - INTRODUCTION AND RESEARCH APPROACH

Problem Statement and Research Objective

The purpose of this study is to analyze the effectiveness and cost-effectiveness of using the Federal Highway Administration's Sign Management And Retroreflectivity Tracking System (SMARTS) van for inventorying signs and evaluating sign retroreflectivity in Alaska.

Although Alaska has a \$20+ million investment in road signs, we currently don't know when signs are knocked down, stolen, or have deteriorated to the point they are no longer legible at night. This creates a potential for safety and liability problems.

The Highway Safety Act of 1966 requires states to have traffic control device inventories. The ITE Traffic Signing Handbook calls a sign inventory "an essential tool" for managing signs.

In addition to the need for an inventory, impending national standards for sign retroreflectivity are going to make it necessary to have a method of measuring it.

In anticipation of the new standards, and to promote sign inventories, the FHWA funded a project to design a van capable of doing inventories and retroreflectivity measurements at highway speeds. If successful, this would greatly reduce the time and money required for these tasks.

Scope of Study

This study was initially intended to determine:

- 1) The accuracy of van-collected data measured by:
 - a) Consistency of multiple retro-reflectivity readings for the same signs.
 - b) Comparison of van readings to handheld meter readings
- 2) Typical sign capture rates for the van under rural and urban conditions (sign capture rate= $\frac{\text{Number of sign photos taken}}{\text{Number of target signs}}$).
- 3) How much it would cost to inventory all signs on Alaska's contiguous road system using the van.
- 4) Whether the data collected by the van is sufficient for a sign inventory.
- 5) Whether van data was easily transferable to a personal computer database.

The scope of the study was limited to items 1 and 2 when we learned that the van did not perform acceptably on them.

Research Approach

Our research consisted of:

- 1) Evaluating signs with the van on a 10 mile rural segment of the Seward Highway (24 signs).
- 2) Evaluating the same 24 signs with a handheld meter.
- 3) Evaluating signs with the van on a 1.2 mile urban segment of Spenard Road in Anchorage (23 signs).
- 4) Analyzing the results.

CHAPTER 2 - FINDINGS

SMARTS Van Operation

Two people are required to operate the van, a driver and a computer operator. The computer operator watches the road on a video screen and targets signs by holding crosshairs on them with a mouse. The system then should lock on to the sign and track it automatically. If successful in tracking the sign, the system will fire a flash and take two pictures (one color, one black and white) of the sign when it gets 200' from the roof-mounted camera pod. The system then stores the pictures as well as sign location data (derived from a GPS system that gives the van's location and a camera-pod mounted laser device that measures the distance to each sign).

The system's automatic tracking lock was not functional during this test, making it necessary to manually hold the crosshairs on signs. This was a difficult task in many instances, especially on bumpy or curvy roads or when signs are installed close to each other.

The sign hardware and software were user-friendly and have a professional appearance.

SMARTS Van Performance

Reliability

In our three-day test, the van's computer system failed several times and needed to be rebooted. At times, the camera system seemed to have a mind of its own and would not respond to operator input. However, the system generally restored itself after rebooting and would resume proper functioning.

Accuracy of Retro-Reflectivity Measurement

Repeatability of van retro-reflectivity readings was unacceptable. As shown in Appendix B, readings on the same signs varied widely from one run to the next. The average difference between high and low readings on signs ranged between 41 and 75 cd / lux / m².

These numbers constitute too high a proportion of normal sign readings (the minimum standard is likely to be 100 cd / lux / m² or less) for the results to be meaningful.

The accuracy of the van-based system as compared to a handheld meter (generally considered the most accurate type of available device) was also unacceptable (see Appendix B). While the van readings were always lower, they correlated poorly with handheld meter readings. The average difference for sign legends was 351%. For backgrounds it was 297%. Individual readings varied widely above and below these figures.

Accuracy of Sign Location

After excluding outliers that may have been the result of incorrectly entered data, the van located signs within an average of 100' of latitude and 180' of longitude, when compared to its readings from other runs. See Appendix C.

Sign Capture Rate

Sign capture rate (number of sign photos taken / number of target signs) varied from 27% to 45% in an urban environment and from 59% to 68% in a rural environment. See Appendix B.

Due to road roughness, road curvature, or the close spacing of signs, some signs were not captured once during four runs.

CHAPTER 3 - INTERPRETATION, APPRAISAL, AND APPLICATIONS

The SMARTS van was an ambitious undertaking for the FHWA. Highly sophisticated technology is required to accurately measure the retroreflectivity of sign legends and backgrounds from a van traveling at highway speed. The FHWA deserves high marks for vision and ambition but, unfortunately, not for execution.

In its current configuration, the van does not provide useful information.

However, if it were modified to live up to its promise, it would be very useful to highway agencies.

General Recommendations

The following improvements would make the van more useful:

- 1) Make retroreflectivity measurement accurate.
- 2) Install a gyro on the camera pod to make it easier for the operator to track signs.
- 3) Make the tracking mechanism work.
- 4) Create a process for doing comprehensive inventories with multiple passes. Ideally, the computer would keep track of missed signs on the first pass and tell the operator which signs to pick up on subsequent passes.

CHAPTER 4 - CONCLUSIONS

- 1) The SMARTS Van's retroreflectivity measuring system is too inaccurate to be useful.
- 2) Even if all its systems were functional, the van is unlikely to ever be capable of collecting data on 100% of the signs along a road on a single pass in urban conditions. Multiple passes will be needed to get comprehensive inventories.
- 3) If the bugs can be worked out, a mobile data collection van of this type is likely to be the most cost-effective method of inventorying signs and measuring retroreflectivity.
- 4) The van provides a much-needed excuse for video game players. Our experience indicated that gamers are much better at running the targeting system than non-gamers.

APPENDIX A – SMARTS Van Background Information

The Retroreflectivity issue started with the recommended use of glass beads in the 1948 MUTCD. The 1954 revision to the MUTCD required pavement marking to be retroreflectorized. The MUTCD has required all markings that have a night time application to have retroreflective properties since 1961.

In 1985 the Center for Auto Safety petitioned FHWA to address standards for retroreflective traffic control devices.

Congress required the MUTCD to be revised to include minimum retroreflectivity levels for pavement markings and traffic signs on all public roads in the 1993 appropriations act. (ISTEA).

In response to the requirement for minimum levels FHWA initiated research studies one of which was a mobile van used to measure retroreflectivity at highway speeds. The early version developed at FHWA's Turner Fairbanks facility had a camera and flash that was connected to periscope similar to a submarine's. This required the operator to look through the viewing reticule to target the sign. (It didn't work very well for AI).

The early version of the van was abandoned in 1994. FHWA decided to let a contract to build a new van meeting certain specifications. Dan Bay and Associates were awarded the contract to develop the new van. The new van was to have auto tracking, one monitor (the original version had three) and measure the entire sign. The new van became the Sign Management And Retroreflectivity Tracking System (SMARTS) van.

To date minimum retroreflectivity standards have not been included in the MUTCD. They are due toward the end of 2001.

APPENDIX B – SMARTS Van RetroReflectivity Performance Data

RetroReflectivity Van Performance Summary

Measure	Seward Hwy 5/29/01		Spenard Rd 5/30/01	
	Legend	Background	Legend	Background
Capture Rate	59% to 68%		27% to 45%	
Repeatability (Range of readings)	75	72	46	41
Avg Difference btwn van & handheld:	351%	297%	not evaluated	not evaluated

Seward Highway Run. Starts at the weight station and goes about 10 miles south. 24 signs.

Spenard Road Run: Starts at Minnesota Drive and goes about 1.2 miles west. 23 signs not including small street name parking, and other minor signs.

Capture Rate: Number of photos captured / Number of signs that should have been captured.

Repeatability: The average difference between low and high reflectivity readings (candelas / lux/ meter²).

Average difference between van and handheld: The difference between the van reading (with a user-selected evaluation area) and the handheld meter reading.

Seward Hwy RetroReflectivity Data - 5-29-01, Computer-selected evaluation area

Sign No	Mile	Sign	Color	Run 1			Run 2			Run 3			Run 4			Legend				Background			
				Data?	Legend	Bkgnd	Data?	Legend	Bkgnd	Data?	Legend	Bkgnd	Data?	Legend	Bkgnd	Avg	Lo	Hi	SD	Avg	Lo	Hi	SD
1	0	Left Lane Ends-W	Yellow	1	9.6	138	1	115.6	-28.9	0			1	-40.1	36.3	28.4	-40.1	116	79.5	48.5	-28.9	138	84.1
2	0.1	Merge Symbol-W	Yellow	0			0			0			0										
3	0.2	55 MPH	White	0			0			1	36.7	0	1	0	0	18.4	0	36.7	26.0	0	0	0	0.0
4	1	Delay 5 Veh -R	White	0			1	-34.5	145	1	0	91.6	1	-44.8	55	-26.4	-44.8	0	23.5	97.2	55	145	45.3
5	1.2	Slow Veh Turnout 1000'	Blue	1	155.7	12.1	1	110.7	-29.7	0			1	34.4	-41.6	100	34.4	156	61.3	-19.7	-41.6	12.1	28.2
6	1.4	Veh Turnout - arrow	Blue	1	162.7	15.4	1	119.6	-37.4	1	66.5	0	1	37.1	-42.1	96.5	37.1	163	55.8	-16	-42.1	15.4	28.2
7	2.7	Brown Camera	Brown	0			0			1	54.9	-51.3	0			54.9				-51.3			
8	2.9	Briown-McHugh Ck	Brown	1	144.3	16.2	1	92.7	-24.8	0			1	27.7	-39.3	88.2	27.7	144	58.4	-16	-39.3	16.2	28.8
9	3.1	Falling Rocks, Next 10 Mi	Yellow	1	5.1	170	1	-35.3	135.8	1	0	89.8	1	-42.7	53.3	-18.2	-42.7	5.1	24.3	112	53.3	170	51.2
10	3.5	Orange-End of Slide Area	Orange	1	0.4	108.3	1	-35	70.4	1	0	29.8	1	-40.8	16.9	-18.9	-40.8	0.4	22.1	56.4	16.9	108	41.5
11	4.2	Blue Camera	Blue	1	0	4.8	1	12.9	-34.8	1	-19.6	0	1	-14.4	-39.2	-5.28	-19.6	12.9	14.7	-17.3	-39.2	4.8	22.9
12	4.3	Beluga Pt-Brown	Brown	1	58.4	10.3	1	-31.6	22.1	1	-27.4	0	1	-20.8	-41	-5.35	-31.6	58.4	42.7	-2.15	-41	22.1	27.4
13	4.5	Stop	Red	1	169.2	39	0			1	51.5	-43.2	1	33.5	-30.4	84.7	33.5	169	73.7	-11.5	-43.2	39	44.2
14	5.9	Blue Camera	Blue	1	22.9	62.5	1	15.4	-27.1	1	-14	0	1	-12.8	-38	2.88	-14	22.9	19.0	-0.65	-38	62.5	45.0
15	6.1	Blue Camera	Blue	1	54.3	14.6	1	22.1	-23.4	1	-19.7	0	1	-20.2	-39	9.13	-20.2	54.3	36.1	-12	-39	14.6	23.9
16	6.3	Blue Trail Sign	Blue	0			1	-4.7	-31.6	1	-29.6	0	1	-21.2	-41.4	-18.5	-29.6	-4.7	12.7	-24.3	-41.4	0	21.6
17	6.4	Blue Trail Sign	Blue	0			0			0			0										
18	7.7	Blue Trail&Blu Camera	Blue	0			1	0	144.3	0			0			0			144				
19	7.9	Yellow Ped Xing	Yellow	0			1	63.1	-29.7	0			0			63.1				-29.7			
20	8	Blue Trail Sign	Blue	0			0			0			0										
21	8.8	55	White	1	13.6	174.2	1	-26.7	135	1	0	88.4	0			-4.37	-26.7	13.6	20.5	133	88.4	174	43.0
22	9	Blue Trail Sign	Blue	1	42.6	10	0			1	-35.1	0	1	-23.6	-43.6	-5.37	-35.1	42.6	41.9	-11.2	-43.6	10	28.5
23	9.1	Blue Trail Sign	Blue	0			0			1	-18.4	0	0										
No of Usable Shots:				13			15			14			15			Lo's and Hi's are only shown when there is more than one reading							
Capture Rate:				59%			68%			64%			68%										

Retro-Reflectivity values are
Candelas / lux / square meter.

	Legend	Background
Average Range in Retro-Reflectivity Values:	75.1	72.2

Seward Hwy RetroReflectivity Data - 5-29-01, User-selected evaluation area

Sign No	Mile	Sign	Color	Run 1			Run 2			Run 3			Run 4			Legend				Background			
				Data?	Legend	Bkgnd	Data?	Legend	Bkgnd	Data?	Legend	Bkgnd	Data?	Legend	Bkgnd	Avg	Lo	Hi	SD	Avg	Lo	Hi	SD
1	0	Left Lane Ends-W	Yellow	1	20.7	138.3	1	-13.6	114.8	0			1	-30.5	38.5	-7.8	-30.5	20.7	26.1	97.2	38.5	138	52.2
2	0.1	Merge Symbol-W	Yellow	0			0			0			0										
3	0.2	55 MPH	White	0			0			1	-52.1	43.2	1	-37.8	18.4	-45	-52.1	-37.8	10.1	30.8	18.4	43.2	17.5
4	1	Delay 5 Veh -R	White	1	13.2	10.4	1	0	147.8	1	0	91.6	1	0	60.3	3.3	0	13.2	6.6	77.5	10.4	148	57.6
5	1.2	Slow Veh Turnout 1000'	Blue	1	155.7	12.1	1	110.7	-29.7	0			1	34.4	-41.6	100	34.4	156	61.3	-19.7	-41.6	12.1	28.2
6	1.4	Veh Turnout - arrow	Blue	1	162.7	15.4	1	120.5	-33.8	1	66.5	0	1	37.1	-42.1	96.7	37.1	163	55.9	-15.1	-42.1	15.4	27.3
7	2.7	Brown Camera	Brown	0			0			1	54.9	-51.3	0			54.9				-51.3			
8	2.9	Briown-McHugh Ck	Brown	1	144.3	16.2	1	92.7	-24.8	0			1	27.7	-39.3	88.2	27.7	144	58.4	-16	-39.3	16.2	28.8
9	3.1	Falling Rocks, Next 10 Mi	Yellow	1	0	189.5	1	0	148.2	1	-51.9	99.1	1	0	63.3	-13	-51.9	0	26.0	125	63.3	190	55.3
10	3.5	Orange-End of Slide Area	Orange	1	13.4	113.7	1	-23.2	74.3	1	0	32.4	1	-37.2	19.3	-11.8	-37.2	13.4	22.7	59.9	19.3	114	42.8
11	4.2	Blue Camera	Blue	1	0	3.3	1	8.6	-29.3	1	-21.3	0	1	-14.4	-39.2	-6.78	-21.3	8.6	13.6	-16.3	-39.2	3.3	21.2
12	4.3	Beluga Pt-Brown	Brown	1	58.4	10.3	1	9.7	-32.9	1	-27.4	0	1	-20.8	-41	4.98	-27.4	58.4	39.1	-15.9	-41	10.3	24.9
13	4.5	Stop	Red	1	177.2	40.5	0			1	64	-37.2	1	41.2	-24.9	94.1	41.2	177	72.8	-7.2	-37.2	40.5	41.8
14	5.9	Blue Camera	Blue	1	22.9	62.5	1	15.4	-27.1	1	-14	0	1	-12.8	-38	2.88	-14	22.9	19.0	-0.65	-38	62.5	45.0
15	6.1	Blue Camera	Blue	1	55.3	15.1	1	22.1	-23.4	1	-19.7	0	1	-20.2	-39	9.38	-20.2	55.3	36.5	-11.8	-39	15.1	24.1
16	6.3	Blue Trail Sign	Blue	0			1	-4.7	-31.6	1	-29.6	0	1	-21.2	-41.4	-18.5	-29.6	-4.7	12.7	-24.3	-41.4	0	21.6
17	6.4	Blue Trail Sign	Blue	0			0			0			0										
18	7.7	Blue Trail&Blu Camera	Blue	0			1	0	-28.7	0			0			0							-28.7
19	7.9	Yellow Ped Xing	Yellow	0			1	-34.2	68.4	0			0			-34.2							68.4
20	8	Blue Trail Sign	Blue	0			0			0			0										
21	8.8	55	White	1	13.6	174.2	1	-26.7	135	1	0	88.4	0			-4.37	-26.7	13.6	20.5	133	88.4	174	43.0
22	9	Blue Trail Sign	Blue	1	42.6	10	0			1	-35.1	0	1	-23.6	-43.6	-5.37	-35.1	42.6	41.9	-11.2	-43.6	10	28.5
23	9.1	Blue Trail Sign	Blue	0			0			1	-18.4	0	0										
No of Usable Shots:				14			15			14			15			Lo's and Hi's are only shown when there is more than one reading							
Capture Rate:				64%			68%			64%			68%										

Retro-Reflectivity values are
Candelas / lux / square meter.

Spenard Road RetroReflectivity Data - 5-30-01, Computer-selected evaluation area

Sign No	Mile	Sign	Color	Run 1			Run 2			Run 3			Run 4			Legend				Background			
				Data?	Legend	Bkgnd	Data?	Legend	Bkgnd	Data?	Legend	Bkgnd	Data?	Legend	Bkgnd	Avg	Lo	Hi	SD	Avg	Lo	Hi	SD
1	0.05	35 MPH & Adopt a Hwy	White / Blue	1	0	0	0			0			0			0				0			
2	0.2	Round RR Sign	Yellow	0			1	-30.5	96.7	0			0			-30.5				96.7			
3	0.21	Road Name - McRae	Green	1	27.8	-12.8	0			0			0			27.8				-12.8			
4	0.23	Keep Right Symbol	White	1	84.2	-27.7	1	123.7	-37.4	0			0			104	84.2	124	27.9	-32.6	-37.4	-27.7	6.9
5	0.23	Xbuck / Do not Stop on Tracks	White	0			0			1	-17.1	108.5	1	-12.5	87	-14.8	-17.1	-12.5	3.3	97.8	87	109	15.2
6	0.36	R10-13 OH	White	0			0			0			0										
7	0.36	Road Name - OH - Taft Dr	Green	1	42.7	-14.4	1	16.2	-33.8	1	9.7	-21.9	0			22.9	9.7	42.7	17.5	-23.4	-33.8	-14.4	9.8
8	0.41	Ctr Ln TWLTL Only	White	0			0			1	-23.3	91	1	82.5	-26.5	29.6	-23.3	82.5	74.8	32.3	-26.5	91	83.1
9	0.52	Keep Right Symbol	White	0			0			1	-21.5	100.3	1	83.3	-29.1	30.9	-21.5	83.3	74.1	35.6	-29.1	100	91.5
10	0.6	R10-13 OH	White	0			0			0			0										
11	0.6	Road Name - OH - Iowa Dr	Green	0			0			1	21.1	-19.8	0			21.1				-19.8			
12	0.6	Merge	Yellow	0			0			0			0										
13	0.61	35 MPH	White	0			1	47.5	-30.3	0			0			47.5				-30.3			
14	0.8	Adopt a Hwy	Blue	1	17.5	-21.5	1	16.8	-25.5	1	16.4	-21.5	1	11.9	-19.7	15.7	11.9	17.5	2.5	-22.1	-25.5	-19.7	2.5
15	0.86	35 MPH	White	0			0			1	-26.4	14.5	1	0	0	-13.2	-26.4	0	18.7	7.25	0	14.5	10.3
16	0.9	Keep Right Symbol	White	0			0			1	-27.4	67.7	0			-27.4				67.7			
17	0.91	Split Road	Yellow	0			0			0			1	3.3	-28.3	3.3				-28.3			
18	0.92	Ctr Ln TWLTL Only	White	0			0			0			0										
19	1.02	Keep Right Symbol	White	0			0			1	-27.3	23.4	1	27.2	-26.1	-0.05	-27.3	27.2	38.5	-1.35	-26.1	23.4	35.0
20	1.1	R10-13 OH	White	0			0			0			0										
21	1.1	Road Name - OH - Wisconsin St	Green	1	40.2	-15.8	1	31.4	-20.5	1	21.8	-20.1	1	-5.2	-14.9	22.1	-5.2	40.2	19.7	-17.8	-20.5	-14.9	2.9
22	1.15	35 MPH	White	0			1	-21.9	17	0			0			-21.9				17			
No of Usable Shots:				6			7			10			8			Lo's and Hi's are only shown when there is more than one reading							
Capture Rate:				27%			32%			45%			36%										

Retro-Reflectivity values are Candelas / lux / square meter.

	Legend	Background
Average Range in Retro-Reflectivity Values:	46.6	41.4

Spenard Road RetroReflectivity Data - 5-30-01, User-selected evaluation area

Sign No	Mile	Sign	Color	Run 1			Run 2			Run 3			Run 4			Legend				Background			
				Data?	Legend	Bkgnd	Data?	Legend	Bkgnd	Data?	Legend	Bkgnd	Data?	Legend	Bkgnd	Avg	Lo	Hi	SD	Avg	Lo	Hi	SD
1	0.05	35 MPH & Adopt a Hwy	White / Blue	1	0	-11.1	0			0			0			0				-11.1			
2	0.2	Round RR Sign	Yellow	0			1	-30.5	96.7	0			0			-30.5				96.7			
3	0.21	Road Name - McRae	Green	1	27.8	-12.8	0			0			0			27.8				-12.8			
4	0.23	Keep Right Symbol	White	1	-23.1	100	1	-33	140	0			0			-28.1	-33	-23.1	7.0	120	100	140	28.3
5	0.23	Xbuck / Do not Stop on Tracks	White	0			0			1	-17.1	108.5	1	-8.2	91.8	-12.7	-17.1	-8.2	6.3	100	91.8	109	11.8
6	0.36	R10-13 OH	White	0			0			0			0										
7	0.36	Road Name - OH - Taft Dr	Green	1	39.6	-13.6	1	19.5	-34.3	1	9.7	-21.9	0			22.9	9.7	39.6	15.2	-23.3	-34.3	-13.6	10.4
8	0.41	Ctr Ln TWLTL Only	White	0			0			1	-23.3	91	1	-21.1	92.5	-22.2	-23.3	-21.1	1.6	91.8	91	92.5	1.1
9	0.52	Keep Right Symbol	White	0			0			1	-21.5	100.3	1	-25.1	97.9	-23.3	-25.1	-21.5	2.5	99.1	97.9	100	1.7
10	0.6	R10-13 OH	White	0			0			0			0										
11	0.6	Road Name - OH - Iowa Dr	Green	0			0			1	21.1	-19.8	0			21.1				-19.8			
12	0.6	Merge	Yellow	0			0			0			0										
13	0.61	35 MPH	White	0			1	-29.8	47	0			0			-29.8				47			
14	0.8	Adopt a Hwy	Blue	1	17.5	-21.5	1	16.8	-25.5	1	16.4	-21.5	1	11.9	-19.7	15.7	11.9	17.5	2.5	-22.1	-25.5	-19.7	2.5
15	0.86	35 MPH	White	0			0			1	-26.4	14.5	1	-25.5	14.6	-26	-26.4	-25.5	0.6	14.6	14.5	14.6	0.1
16	0.9	Keep Right Symbol	White	0			0			1	-27.4	67.7	0			-27.4				67.7			
17	0.91	Split Road	Yellow	0			0			0			1	-28.6	4.6	-28.6				4.6			
18	0.92	Ctr Ln TWLTL Only	White	0			0			0			0										
19	1.02	Keep Right Symbol	White	0			0			1	-27.3	23.4	1	-26.3	27.4	-26.8	-27.3	-26.3	0.7	25.4	23.4	27.4	2.8
20	1.1	R10-13 OH	White	0			0			0			0										
21	1.1	Road Name - OH - Wisconsin St	Green	1	40.2	-15.8	1	32.4	-21.5	1	21.8	-20.1	1	0	-28.6	23.6	0	40.2	17.4	-21.5	-28.6	-15.8	5.3
22	1.15	35 MPH	White	0			1	-21.9	17	0			0			-21.9				17			
No of Usable Shots:				6			7			10			8			Lo's and Hi's are only shown when there is more than one reading							
Capture Rate:				27%			32%			45%			36%										

Retro-Reflectivity values (Ra) are
Candelas / lux / square meter.

Seward Hwy RetroReflectivity Data, Comparison of Handheld Meter and Van Readings

Sign No	Mile	Sign	Color	Legend			Background		
				Handheld Meter Reading	Avg Van Rdg (User Selected eval area)	Difference	Handheld Meter Reading	Avg Van Rdg (User Selected eval area)	Difference
1	0	Left Lane Ends-W	Yellow	1	-7.8	880%	176	97.2	45%
2	0.1	Merge Symbol-W	Yellow	0		n/a	30		n/a
3	0.2	55 MPH	White	0	-45.0	n/a	311	30.8	90%
4	1	Delay 5 Veh -R	White	2	3.3	65%	236	77.5	67%
5	1.2	Slow Veh Turnout 1000'	Blue	282	100.3	64%	4	-19.7	593%
6	1.4	Veh Turnout - arrow	Blue	329	96.7	71%	5	-15.1	403%
7	2.7	Brown Camera	Brown	298	54.9	82%	14	-51.3	466%
8	2.9	Briown-McHugh Ck	Brown	234	88.2	62%	12	-16.0	233%
9	3.1	Falling Rocks, Next 10 Mi	Yellow	3	-13.0	533%	237	125.0	47%
10	3.5	Orange-End of Slide Area	Orange	19	-11.8	162%	131	59.9	54%
11	4.2	Blue Camera	Blue	103	-6.8	107%	7	-16.3	333%
12	4.3	Beluga Pt-Brown	Brown	63	5.0	92%	5	-15.9	418%
13	4.5	Stop	Red	229	94.1	59%	47	-7.2	115%
14	5.9	Blue Camera	Blue	76	2.9	96%	10	-0.7	107%
15	6.1	Blue Camera	Blue	95	9.4	90%	12	-11.8	199%
16	6.3	Blue Trail Sign	Blue	58	-18.5	132%	3	-24.3	911%
17	6.4	Blue Trail Sign	Blue	49		n/a	4		n/a
18	7.7	Blue Trail&Blu Camera	Blue	63	0.0	100%	4	-28.7	818%
19	7.9	Yellow Ped Xing	Yellow	1	-34.2	3520%	149	68.4	54%
20	8	Blue Trail Sign	Blue	76		n/a	4		n/a
21	8.8	55	White	0	-4.4	n/a	278	132.5	52%
22	9	Blue Trail Sign	Blue	58	-5.4	109%	4	-11.2	380%
23	9.1	Blue Trail Sign	Blue	73	0.0	100%	4	0.0	100%

Retro-Reflectivity values are
Candelas / lux / square meter.

Average: 351%
Minimum: 59%
Maximum: 3520%

Average: 297%
Minimum: 45%
Maximum: 911%

APPENDIX C – SMARTS Van GPS Performance Data

Seward Hwy GPS Sign Location Data, 5-29-01, Summary (Excluding Run 2)

Sign No	Mile	Sign	Color	No of Rdgs	Latitude (min.)					Longitude (min.)				
					Avg	Lo	Hi	Range		Avg	Lo	Hi	Range	
								Minutes	~ Feet				Minutes	~ Feet
1	0	Left Lane Ends-W	Yellow	2	2.727	2.724	2.73	0.006	46.1	2	47.396	47.399	0.003	23.0
2	0.1	Merge Symbol-W	Yellow	0					0.0	0	0	0	0	0.0
3	0.2	55 MPH	White	2	2.663	2.661	2.665	0.004	30.7	2	47.313	47.315	0.002	15.4
4	1	Delay 5 Veh -R	White	3	2.088667	2.084	2.092	0.008	61.4	3	46.411	46.432	0.021	161.3
5	1.2	Slow Veh Turnout 1000'	Blue	3	1.996667	1.991	2	0.009	69.1	3	46.133	46.156	0.023	176.6
6	1.4	Veh Turnout - arrow	Blue	3	1.876667	1.87	1.884	0.014	107.5	3	45.913	45.949	0.036	276.5
7	2.7	Brown Camera	Brown	2	1.111	1.105	1.117	0.012	92.2	2	44.458	44.504	0.046	353.3
8	2.9	Brown-McHugh Ck	Brown	3	1.021	1.014	1.028	0.014	107.5	3	44.225	44.229	0.004	30.7
9	3.1	Falling Rocks, Next 10 Mi	Yellow	3	0.965333	0.96	0.973	0.013	99.8	3	43.865	43.902	0.037	284.1
10	3.5	Orange-End Slide Area	Orange	3	0.844333	0.837	0.855	0.018	138.2	3	43.047	43.104	0.057	437.7
11	4.2	Blue Camera	Blue	3	0.638	0.63	0.644	0.014	107.5	3	42.07	42.088	0.018	138.2
12	4.3	Beluga Pt-Brown	Brown	3	0.558667	0.55	0.573	0.023	176.6	3	41.802	41.82	0.018	138.2
13	4.5	Stop	Red	3	0.436333	0.429	0.449	0.02	153.6	3	41.663	41.68	0.017	130.6
14	5.9	Blue Camera	Blue	3	0.150333	0.145	0.154	0.009	69.1	3	39.437	39.469	0.032	245.7
15	6.1	Blue Camera	Blue	3	0.074333	0.066	0.079	0.013	99.8	3	39.196	39.208	0.012	92.2
16	6.3	Blue Trail Sign	Blue	2	59.974	59.971	59.977	0.006	46.1	2	38.9	38.907	0.007	53.8
17	6.4	Blue Trail Sign	Blue	2	59.663	59.332	59.994	0.662	5083.8	2	36.913	38.655	1.742	13377.6
18	7.7	Blue Trail&Blu Camera	Blue	1	59.319	59.319	59.319	0	0.0	1	36.988	36.988	0	0.0
19	7.9	Yellow Ped Xing	Yellow	1	59.231	59.231	59.231	0	0.0	1	36.781	36.781	0	0.0
20	8	Blue Trail Sign	Blue	1	59.125	59.125	59.125	0	0.0	1	36.649	36.649	0	0.0
21	8.8	55	White	3	58.946	58.94	58.951	0.011	84.5	3	35.338	35.362	0.024	184.3
22	9	Blue Trail Sign	Blue	3	58.95733	58.949	58.963	0.014	107.5	3	35.064	35.104	0.04	307.2
23	9.1	Blue Trail Sign	Blue	3	58.98933	58.981	59.002	0.021	161.3	3	32.291	34.871	2.58	19813.0

Average: 360.1
Avg w/o Outliers: 97.7

Average: 1907.3
Avg w/o Outliers: 179.3

Feet per Minute Approximation

Radius of Earth (approx.): 5000
 Circumference of Earth (approx.): 31416
 Feet per Degree (approx.): 460767
 Feet per Minute (approx.): 7679.4

Seward Hwy GPS Sign Location Data, 5-29-01, Runs 1 and 2

Sign No	Mile	Sign	Color	Run 1						Run 2						
				Latitude			Longitude			Latitude			Longitude			
1	0	Left Lane Ends-W	Yellow	err	N		err	W			61	N	10.7		W	
2	0.1	Merge Symbol-W	Yellow													
3	0.2	55 MPH	White													
4	1	Delay 5 Veh -R	White	61	N	2.092	149	W		46.423	61	N	10.756	149	W	57.752
5	1.2	Slow Veh Turnout 1000'	Blue	61	N	1.999	149	W		46.14	61	N	10.756	149	W	57.752
6	1.4	Veh Turnout - arrow	Blue	61	N	1.876	149	W		45.913	61	N	10.756	149	W	57.752
7	2.7	Brown Camera	Brown								61	N	10.756	149	W	57.752
8	2.9	Briown-McHugh Ck	Brown	61	N	1.028	149	W		44.225	61	N	10.756	149	W	57.752
9	3.1	Falling Rocks, Next 10 Mi	Yellow	61	N	0.973	149	W		43.902	61	N	10.756	149	W	57.752
10	3.5	Orange-End Slide Area	Orange	61	N	0.855	149	W		43.104	61	N	10.756	149	W	57.752
11	4.2	Blue Camera	Blue	61	N	0.644	149	W		42.073	61	N	10.756	149	W	57.752
12	4.3	Beluga Pt-Brown	Brown	61	N	0.573	149	W		41.82	61	N	10.756	149	W	57.752
13	4.5	Stop	Red	61	N	0.449	149	W		41.68						
14	5.9	Blue Camera	Blue	61	N	0.154	149	W		39.437	61	N	10.756	149	W	57.752
15	6.1	Blue Camera	Blue	61	N	0.079	149	W		39.196	61	N	10.756	149	W	57.752
16	6.3	Blue Trail Sign	Blue								61	N	10.756	149	W	57.752
17	6.4	Blue Trail Sign	Blue	60	N	59.332	149	W		36.913						
18	7.7	Blue Trail&Blu Camera	Blue								61	N	10.756	149	W	57.752
19	7.9	Yellow Ped Xing	Yellow								61	N	10.756	149	W	57.752
20	8	Blue Trail Sign	Blue								61	N	10.756	149	W	57.752
21	8.8	55	White	60	N	58.951	149	W		35.362	61	N	10.756	149	W	57.752
22	9	Blue Trail Sign	Blue	60	N	58.963	149	W		35.068	61	N	10.756	149	W	57.752
23	9.1	Blue Trail Sign	Blue	60	N	58.985	149	W		32.291						

The van malfunctioned on run 2 - all signs are recorded at the same location. This data was not included in the summary.

Seward Hwy GPS Sign Location Data, 5-29-01, Runs 3 and 4

Sign No	Mile	Sign	Color	Run 3						Run 4						
				Latitude			Longitude			Latitude			Longitude			
1	0	Left Lane Ends-W	Yellow	61	N	2.724	149	W		47.396	61	N	2.73	149	W	47.399
2	0.1	Merge Symbol-W	Yellow													
3	0.2	55 MPH	White	61	N	2.661	149	W		47.313	61	N	2.665	149	W	47.315
4	1	Delay 5 Veh -R	White	61	N	2.084	149	W		46.411	61	N	2.09	149	W	46.432
5	1.2	Slow Veh Turnout 1000'	Blue	61	N	2	149	W		46.156	61	N	1.991	149	W	46.133
6	1.4	Veh Turnout - arrow	Blue	61	N	1.87	149	W		45.923	61	N	1.884	149	W	45.949
7	2.7	Brown Camera	Brown	61	N	1.117	149	W		44.504	61	N	1.105	149	W	44.458
8	2.9	Brown-McHugh Ck	Brown	61	N	1.014	149	W		44.229	61	N	1.021	149	W	44.226
9	3.1	Falling Rocks, Next 10 Mi	Yellow	61	N	0.96	149	W		43.891	61	N	0.963	149	W	43.865
10	3.5	Orange-End Slide Area	Orange	61	N	0.837	149	W		43.064	61	N	0.841	149	W	43.047
11	4.2	Blue Camera	Blue	61	N	0.63	149	W		42.07	61	N	0.64	149	W	42.088
12	4.3	Beluga Pt-Brown	Brown	61	N	0.553	149	W		41.815	61	N	0.55	149	W	41.802
13	4.5	Stop	Red	61	N	0.431	149	W		41.679	61	N	0.429	149	W	41.663
14	5.9	Blue Camera	Blue	61	N	0.145	149	W		39.464	61	N	0.152	149	W	39.469
15	6.1	Blue Camera	Blue	61	N	0.066	149	W		39.198	61	N	0.078	149	W	39.208
16	6.3	Blue Trail Sign	Blue	60	N	59.971	149	W		38.907	60	N	59.977	149	W	38.9
17	6.4	Blue Trail Sign	Blue	60	N	59.994	149	W		38.655						
18	7.7	Blue Trail&Blu Camera	Blue	60	N	59.319	149	W		36.988						
19	7.9	Yellow Ped Xing	Yellow								60	N	59.231	149	W	36.781
20	8	Blue Trail Sign	Blue								60	N	59.125	149	W	36.649
21	8.8	55	White	60	N	58.94		W		35.339	60	N	58.947	149	W	35.338
22	9	Blue Trail Sign	Blue	60	N	58.949	149	W		35.104	60	N	58.96	149	W	35.064
23	9.1	Blue Trail Sign	Blue	60	N	58.981	149	W		34.871	60	N	59.002	149	W	34.795

APPENDIX D – SMARTS Van Operation Manual

Draft

**RETROREFLECTIVITY SIGN VAN
OPERATOR'S MANUAL
DECEMBER, 1999**

EQUIPMENT DESCRIPTIONS

The following are descriptions of the major components of the Retroreflectometer as well as their functions:

THE TURRET

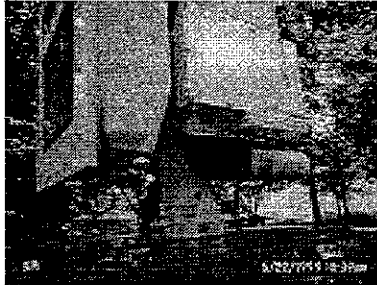

There are three main components to the turret:

- (1) A main flash unit - a Xenon flash tube located at the lower portion of the turret,
- (2) Laser range finder located above the main flash unit, and
- (3) Three cameras - one 50 mm monochrome lens; one 75 mm monochrome lens; and one 50 mm color tracking camera.

The turret is able to rotate 180 degrees for storage; however, its rotation is limited to less than +80 degrees while in operation. This is a built-in safety feature so that during operation (tracking), the mount's position is limited to the general area of where the sign would be and won't "run away with itself" thus becoming uncontrollable.

Stow Pins

Located below (almost underneath) the turret are the stow pins. The main function of the stow pins are to prevent the turret from tipping while the van is moving with the system off. It is also important to note that the mount will not move if the stow pins are not in their storage location (at the base of the turret) during operation.

Stow Pin Positions (Non-operational Turret Storage)

The normal non-operational position for the unit (the turret) is backwards, that is, when the Turret is "stowed," the front of the unit is facing in the direction of the back of the van.

Operator Station



Driver Electronics -

The Driver Electronics is a black box located on the floor and to the left of the operator station. The Driver Electronics (for the mount) contains the power supply for the laser and one to two small custom electronic boards for camera shutter control.



Flash Power Supply -

Above the Driver Electronics box is a silver box which is the Flash Power Supply. It provides energy to activate the camera's flash.

Inverter

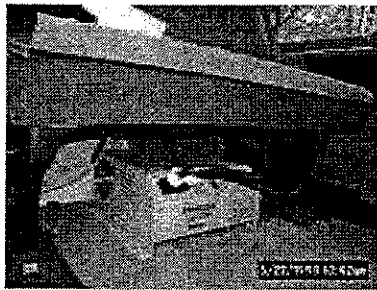

The Inverter is located underneath the passenger seats. It provides 2,000 watts of power and its function is to convert 12 volts of automotive power to 110 volts of AC. It is the main power supply - it gives power to all retroreflectivity components in the vehicle including the work station (everything that is powered by AC). For these vans, there are two different versions of inverters. Three of the vans have inverters which contain switches and plugs in the front of the unit (these are beige in color). One van has an inverter which does not contain any outward plugs or switches. Instead, this model has plugs wired within the box and the operating switch is located along with the other van controls - it is white in color. When external power is available, for example during trade shows, the AC can be removed from the inverter and plugged into an extension cord (or power strip) attached to external 120 volts.



Also, within the back of each van are 2 deep-cycle marine batteries that can provide power to run the inverter for up to 1 hour with the van's engine off. These batteries are charged by vehicle power (via the van's alternator). While the van is running (the motor is on), the batteries are always charging. However, there is isolation between the vehicle's batteries and the batteries used for the inverter and operator station to prevent the marine batteries from discharging back through the van's electrical system. The vehicle's (heavy duty - 190 amp) alternator feeds them both.



Display Monitor and keyboard -

All vans have the same style (flat) computer monitor, keyboard and software installed, as well as the same standard color (black). The monitor is a 13.1 - 13.8 inch flat panel. The primary reason for the flat monitor vs. a regular monitor is that the image on a flat monitor is stable even when the van isn't (the same isn't true with a regular monitor.) Also there is the issue of depth. The flat monitor doesn't interfere with the driver's view of the side view mirror.

Computer Hardware



Zip Drive -

For all vans, the operator's station will include the following:

- One Dual Pentium 200 - 233 Mhz Machine,
- One IOMEGA - 100 megabyte zip drive,
- One CD ROM drive,
- One 2-gigabyte removable,
- One 2 to 4-gigabyte internal hard drive and standard floppy drive; and
- 64 megs of RAM

The primary purpose of the zip drive is to give data to the persons who are participating in the demonstration. The computer is capable of retaining up to an hour's worth of data including, reflectivity, images - both black and white and color, and putting a viewing package together. It's a SCSI-based system, which allows maximum data speed between peripherals and the CPU.

Hard Drive -

2.1 gigabytes will store up to 1 day's worth of data.

Storing data -

Data is stored directly on the internal 2.1 Gig hard drive and then is transferred to the removable drive that can later be taken back to the office and downloaded to another computer, tape, etc.

Cooling Fan -

At the base of the monitor is the cooling fan. While the van is in operation, the excessive heat generated from the use of the computer (which can greatly affect the heat-sensitive components) is not really a concern while air conditioning from the van is available. However, during demonstrations when the van is stable (with its motor turned off) and the doors are open, temperature is not (always) easily controllable. It is under these conditions that the built-in cooling fan is most useful in eliminating potential (overheating) problems.

Fold Down Table -

Each operator station includes a fold down table, which while in the "up" position allows for easy access to and from the seat. (This is important due to the limited amount of space for the "Operator's Station.")

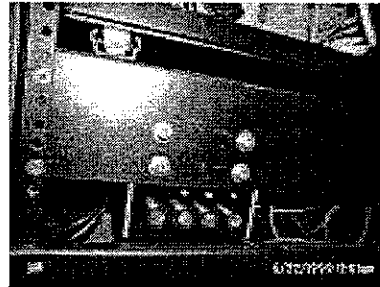

Fuse Box -

Located directly behind the computer monitor and drives (in front to the right of the driver's seat), is the power supply box for the three cameras (located in the turret). In the supply box are four fuses and three LEDs. If any or all of the LEDs (indicator lights) are out, this indicates that one or all fuses are out. To discover this, look at the lights which are labeled accordingly, to see if any are out. The last fuse labeled is the AC fuse. Lights on indicate power going to the cameras.

SOFTWARE/DISPLAY OUTLINE



1. The Image Controls (left side of screen)
2. The System Status Calibration Box (across the top of the screen)
3. The Range Finder (across the bottom of the screen)
4. Menu (right side of screen)

Rotating Beacon



The Rotating Beacon is a small orange light located on the roof of the van behind the turret. It is used to warn other road users that a possibly hazardous operation is in progress.

SOFTWARE DISPLAY

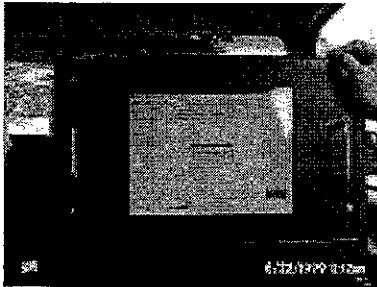

Under Functions Menu box

These are functions you can choose from the function drop-down menu, shown in figure

Operate View - used for operation

Demo View - used for van demonstrations in trade shows

Calibrate View - brings up screen calibrations for video, mount and sign(s). Normally, the video and mount settings are already calculated and established/set - the operator doesn't have to concern his/herself with this feature.



**Brightness and Contrast controls are located on the left side of the screen*

Brightness Value - is strictly a display feature and does not affect the settings of the camera(s) nor the contrast.

Contrast Value - Also, does not affect the settings of the camera or of the tracking. It merely changes what the operator sees (on the screen).

Delay Value - The Delay Value should NEVER be changed. It is the time difference between when the system gives the command to "flash" and the message gets to the (computer) card (designed by the van's engineers). The delay synchronizes the light from the flash with the shutter opening so that the image is taken as close to the peak brightness as possible. In other words, it is the delay from the vertical sync pulse of the camera and to where it flashes within the frame. This delay is approximately 10 microseconds. It's slightly different from every shutter position.

View Menu - Allows the operator to change the Brightness and Contrast values. Once changed, the numbered values will be stored, as well as the color shutter positions (which can also be changed when at this menu). This affects the camera, the black and white shutter, and the measurement.

Mouse Button Functions

The system uses a 3-button mouse.

The left mouse button - The mount's aim moves immediately to the clicked point on the screen. This can be used while in motion as a course single step to a given location. However, this doesn't initiate track so the clicked point quickly moves from under the "crosshairs" cursor when used under motion.

The middle mouse button - This is the "go to" button. If the button is pressed (held down) while moving the mouse, the mount is able to follow the cursor as the mouse is moved. The mount will stop at whatever point the operator stops moving the mouse. This button can be used to initially find the sign in the image before initiating track. Once the desired sign is positioned in the center of the screen, the right mouse button can be pressed.

The right mouse button - This button is identical in operation to the middle button, with the additional function of initiating tracking. A red square appears on the screen when an object is actively tracked. The position of the red square shows where the computer will move the mount when the right mouse button is released, which will activate the auto track function. The red square should be in the center of the screen directly over the green square. All signs should be manually aimed with the right mouse button depressed into this green square and the red tracking square should align over the green square when correctly tracking the sign. Slight movement of the red tracking square is normal. Once the red tracking square is consistently over the green square, the right mouse button can be released. The sign will now be tracked until the snap distance is reached.

Definition: Snap- the flashing and capturing of the sign's retro-reflective image.

NOTE: The system must be monitored while the sign is actively tracked. If an object, such as a tree, interferes with the tracking function, the mount and the red square will travel off of the desired sign. The operator must reinitiate the track with the right mouse button on the desired sign. Depending on the operational environment, this may happen several times before the snap occurs. If great difficulty is had in auto tracking the sign, the operator may have to manually track the object with the right mouse button depressed.

If the tracking system doesn't "lock" onto the desired object (i.e., a sign), but rather, locks onto another object (i.e., a truck), the tracking angle may go beyond the pre-established, software limits of the mount. The software program has a built in command that will cause the tracking system to automatically return to a setting of zero, zero (0,0) and the tracking at this point will be off. At this point, the operator must redesignate the sign to be tracked. Tracking will not occur beyond +80 degrees azimuth and -9 degrees to 25 degrees elevation. The system will permit tracking beyond these limits in the 'demo mode'.

Auto Return to Center -

If 'auto return to center' is checked, the mount returns automatically to aiming straight ahead and level after each snap. If 'auto return to center' is not checked, the mount will stay where it was before the snap. In other words, If 'auto return to center' is checked (set) the aim point automatically returns to the center after every camera snap.

Set-Up Menu -

When looking at the SET UP menu, a "default set up" is already in place. The values that were last stored in the registry, including the Brightness values, whether or not the Status Bar and Tool Bar was turned off, the same values will reappear until they are manually changed. Also, the set-up values are never the same from one session to the next. The values have to change.

The color shutter is very interactive. It depends on variables such as weather conditions (overcast - cloudy, days), the location of the vehicle (under bridges), etc.

The black and white shutter is something that is determined by the intensity of the sign. For brighter signs, the set-ups have to be changed so that the view isn't completely saturated or "white-out." For weaker signs, the set-ups have to be changed such that the sensitivity of the lens is increased. It is recommended that the operator begin with viewing values of around 4 or 5 (making changes as necessary while viewing the screen). The changes can be made under Operate View — located under the Functions Menu option.

Other Descriptions:

Auto Store Data Set -

This setting will store data captured for each sign reading (in incrementing file names). If not set, the system snaps a picture of the sign, but doesn't store any data.

The range designation is measured in feet by default, but can be switched to metric. This number changes based on the image being viewed. There is a range sensitivity of 3-4 feet.

Signal strength (laser) is 50-90%. This is so a good return from the sign is achieved.

As mentioned earlier, for the purpose of conducting demonstrations, there is 45 minutes to 1 hour of full charge when running the system using the battery without aid from the van's engine. After that, the operator runs the risk of having the entire system shut down (and possibly losing valuable information).

System status - Shows operational condition of system. The values can be "standby", "storing data", "Finding Home" or "tracking". The system is generally in standby mode.

Image Quality - Refers to the tracking parameter for the van. It sometimes indicates how well the equipment is tracking.

Data Index - The index into the data set that the operator is running on at any given moment. This feature shows the number of images which have been stored.

Master File Name - This does not change in a session unless the operator goes to the file (menu) and then to the "new" or "save as" (option) which automatically assigns a new data index and data set name (which has embedded in it the julian date, year and 24 hour time in minutes)

Also, within the 'data set' is an index number for each point taken. The data is stored in separate files with separate file names with black and white images as well as color images. The data set name is different. There are three types of files that can be stored in this system. Each image is a separate file. This is automatically assigned by the system.

The default file naming convention is the following:

Data set master file (smarts file type): DataSet(julian day of the year)(hr and min of first sign collect)(yr).smd i.e.: DataSet142183498.smd - 142nd day of 1998 at 18:34 hrs

Black and white bitmap image file: BW(julian day of the year)(hr and min and sec of specific sign collect)(yr).bmp i.e.: BW14219053398.bmp - 142nd day of 1998 at 19:05.33 hrs

Color bitmap image file: Color(julian day of the year)(hr and min and sec of specific sign collect)(yr).bmp i.e.: Color14219053398.bmp - 142nd day of 1998 at 19:05.33 hrs

Set-up and Alignment:

First, the Stow Pins are to be taken down and placed in the drive position (being most concerned about the elevation pin)

Next, sit at the operator's station and turn on the inverter (beige box under passenger's seat directly behind the operator's seat). The monitor will "power up" and the computer can be turned on. DO NOT turn on the drive electronics box until the program is running. As the computer is "booting up" go through the NT login (which is a standard NT login). Once the computer displays a login screen, simultaneously hit the "CTRL", "ALT" and "DELETE" buttons. Next, enter the given "user level/demo level" password. At this point an icon for the "Shortcut to Smart EXE" should appear on the desktop. Double click on it. This brings the program up and if it isn't already, you should enlarge it to full screen.

Once the program is up, **NOW** turn on the driver electronics box as well as the flash (the silver box above the driver electronics box).

PLEASE NOTE:The program must be up before the driver electronics box can be turned on.

Now, adjust the color shutter so that a clear picture is obtained. The color shutter "box" as well as the black and white shutter "box" is located in the bottom left corner of the screen. Use of the up and down arrow keys will also allow the operator to adjust the color shutter. Next, find the home button and use it to find mount home position. It takes approximately 30 seconds to find the mount home position. Each time the computer and the mount are turned on, the system must find "home" first. It will show the "as now position" to be "0,0". This is displayed at the top of the screen. The "0,0" position reading is the reference point by which all measurements are taken.

Calibration:

In order to perform calibrations, the object to be calibrated has to be placed 200 ft away from the van, as determined by the laser range value. Once an item has been identified for calibration, & placed at the correct distance, the operator will enter a lab-determined value for the calibration sign after pressing the "Sign Calibration" button of the "calibration view" function window. Next, the system will determine the bias value & then the scale value for that particular sign.

NOTE: Before beginning to take a bias value reading, the top portion of the turret, where the cameras are located, must be covered with a black sheet of cardboard. The entire turret does not have to be covered. However the area of the camera must be entirely covered.

Bias value- Refers to the measurement of the black bias of the camera (the measurement of the black background noise).

Scale value- Refers to the multiplying value of a line equation ($y = \text{scale} * x + \text{bias}$). Calculated from the bias and the known measured value of the calibration sign (y).

To conduct bias calibration, simply place a black board in front of the cameras and press the "bias calibration" button. When the camera flashes, the bias calibration will be for the image taken (dark screen). The computer will measure the entire area. The operator should remember to make sure that the board used is blocking all direct sunlight to the camera(s). A 50 mm or 75 mm lens will be used for this purpose.

Next choose "gain calibration". The system will flash and show the operator the entire image. If there is one sign with the image, the red square will be around it (the one sign) and will automatically select it. In cases, where this doesn't happen automatically, the operator will select the desired image, using the left mouse button to put the red square around any part of the (white) sign, after which, a new gain value will be assigned. Thus, the sign will be calibrated using the lab value given.

In summary, the sign is calibrated using calibration values for the sign selected based on its measured lab value. The operator calculates the bias which is the background "noise" of the camera and then calculates the gain value based on the reflectivity measured from the area of the high-lighted sign (using the red box) & only that which is contained within the red box.

Once the calibration is taken, it's value will be used to calibrate all future measurements, until another calibration is taken.

NOTE: The operator does not have to calibrate differently based on different sign colors. Also, if the CANCEL button is pressed, all new calibrations will be discarded and the previous values reinstated. Therefore, it is important to save the data collected, by selecting the "OK" button (this will store the values collected). When taking measurements and doing calibrations, it is preferred that all-white signs are used. Also, when trying to take a measurement on a sign, the view of the sign must be placed within the red box.

Data Capture/Data Transfer— Operate View

Start and Stop Tracking- The operator has to be in the tracking mode in order to start and stop tracking

Mount Controls - Is a pull down menu, which does the same as the tool bar buttons of the same name.

These are the options (selections):

Find Home - go to zero, zero (Must be used once at each power up to locate forward and level for the mount controller.)

SF - Store Forward

SB - Store Backward

Reset Mount - Reset mount

(All of these features are located on the tool bar)

Reset (button) - This button resets the camera and mount ("wakes up" the mount from any unusual location/position it may be in). This button doesn't change any pre-established values, positions or calibrations.

50 mm camera or 75 mm camera - Determines which black and white camera is used for data capture.

Demo view -

This option is used for conducting demonstrations at a site. The operator will get a new screen that is almost identical to the "Operating View" screen. The buttons are in the same location as the 'view' feature (operate view) with a few additions the additions are:

Under DEMO CONTROL

Start demonstration

Stop demonstration

Set demonstration

Both the 'Start' and 'Stop' demonstration controls are self explanatory

The 'Set demonstration' (show mode) feature allows the operator to select a particular point in a scene (within the aiming square - limited by the travel distance of the turret) that sets the selected point of reference. The aiming point will simulate a search mode by tracking around the screen for two or three minutes at a time. Once away for two or three minutes, it automatically returns to the selected reference point and will randomly flash, take a black-and-white image of the sign and then return to random motion.

While in the 'Show Mode', the color shutter and the black-and-white shutter are functional

Flash Only -

This feature does just that. It flashes only and does nothing else - it remains in the black-and- white mode.

Demo Mode -

To use this feature, move the middle mouse button or left tracking button and the system will override the demo (which is still running) and move the aimpoint away from section initially selected. During a demonstration, click on a sign and select 'flash only' — the camera will flash the sign and keep the black and white image of it. At this point, if the operator returns back to the 'mono' option, and the image is lost.

Flash & Process -

This option can be used to actually store the data only if 'auto store' preference is selected.

Auto return to center also functions in the 'demo mode.'

System Shutdown

The following are the procedures necessary to successfully shut off the system.

1. Store turret (press the SB button - Store backwards button) This causes the turret to go to the stowed position. It stops at approximately 180 degrees. The operator should make sure the turret is properly aligned with the pin positions. The operator will put the pins in before shutting off the computer to insure that the mount does not drift.
2. Put the pins in the mount.
3. Turn the Black box (Driver Electronics) off. This will allow the operator to physically move the mount if step two was not done. Make sure that the pin and mount are properly aligned. If the Driver Electronics is not turned off at this point, it will be impossible to manually move the mount.
4. Next, press the "File Exit" button and then select "Start", "Shut Down". This turns the computer off (shuts down the computer)
5. Turn the computer power switch off
6. Turn off the Inverter under the rear seat.

APPENDIX E – Handheld Meter Manual

DELTA Light & Optics
Hjortekærsvej 99
DK-2800 Lyngby
Denmark

Tel. (+45) 45 88 83 33
Fax (+45) 45 87 08 10

E-mail: Opelec@delta.dk
Internet: www.delta.dk



DELTA Light & Optics

RetroSign[®]
RETROREFLECTOMETER
Manual

On site quality verification of road signs



INDEX

SECTION 1	1-1
INTRODUCTION	1-1
RetroSign® introduction	1-1
RetroSign retrometer features	1-2
Options	1-3
SECTION 2	2-1
OPERATING INFORMATION	2-1
Getting started	2-1
Icons	2-1
Sequence id	2-2
Keyboard functions	2-2
Calibration	2-2
Fast calibration	2-3
Full calibration	2-3
Zero	2-3
Reference	2-3
Menu system	2-3
Remove top data in log	2-4
Data log enable / disable	2-4
Data log clearing	2-4
Off time (power save)	2-4
Initialize instrument	2-4
Display light	2-4
Clear Seq_ID	2-4
Sequence ID	2-4
Battery / charging	2-5
Remote control	2-5
External trigger	2-5
Serial communication	2-5
Aperture Reduction	2-6

APPENDIX C

QUICK GUIDE FOR RETROSIGN EXTENSION KIT

Connection

The battery is mounted by unscrewing the bottom plate and removing the battery container. Then inserting the new battery, notice that the red wire end of the battery container must be connected to + on the battery. Then assemble the Extension kit again.

Mount the Extension kit to the Extension pole by using the two screws and the back profile that is included in the package.

Connect the Extension kit to the RetroSign by inserting the cable connector into the RetroSign.

Getting started

Turn on the RetroSign.

Take a measurement by pressing the <R'> button on the Extension kit. In this order the display shows:

(The measurement is an example):



The result of the measurement is the same as shown on the RetroSign and the instrument is now ready for a new measurement, just press the <R'> button ones again.

If no measurements are made, the Extension kit will keep the RetroSign alive for app. 4 minutes, then the Extension kit will automatically shut down and the RetroSign will shut down according to the time-out for this instrument.

If an error occurs during a measurement the Extension kit show:



is can be a calibration error, battery error or something else, according to the RetroSign manual.

When this happens, take down the RetroSign for examination.

When the < R' > button is pressed on the Extension kit, when the RetroSign is turned off, the Extension kit will show " Err " the moment the RetroSign is turned on again. This is no error, just push the < R' > once again and the measurement is made.

Battery

The battery should be changed at least every year.

When the Extension kit is not used it will still use a small amount of power, so do not mount the battery before use.

When the battery voltage is low, the display will show a battery warning. The "LO BAT" warning tells the user that the battery should be changed in the near future.

When the battery is changed be unscrewing the bottom plate, removing the battery container and using a screwdriver to remove the old battery. Put in a new battery and assemble the extension kit again.

The battery type is: DL123A, 3V, 1.300mAh. (or similar)

DISCLAIMER

The information contained in this document is subject to change without notice.

DELTA LIGHT & OPTICS MAKES NO WARRANTY OF ANY KIND WITH REGARD TO THIS MATERIAL, INCLUDING, BUT NOT LIMITED TO, THE IMPLIED WARRANTIES OF MERCHANTABILITY AND FITNESS FOR A PARTICULAR PURPOSE. DELTA LIGHT & OPTICS SHALL NOT BE LIABLE FOR ERRORS CONTAINED HEREIN OR FOR INCIDENTAL OR CONSEQUENTIAL DAMAGES IN CONNECTION WITH THE FURNISHING, PERFORMANCE OR USE OF THIS MATERIAL.

Rev. 280699

Dimensional drawings

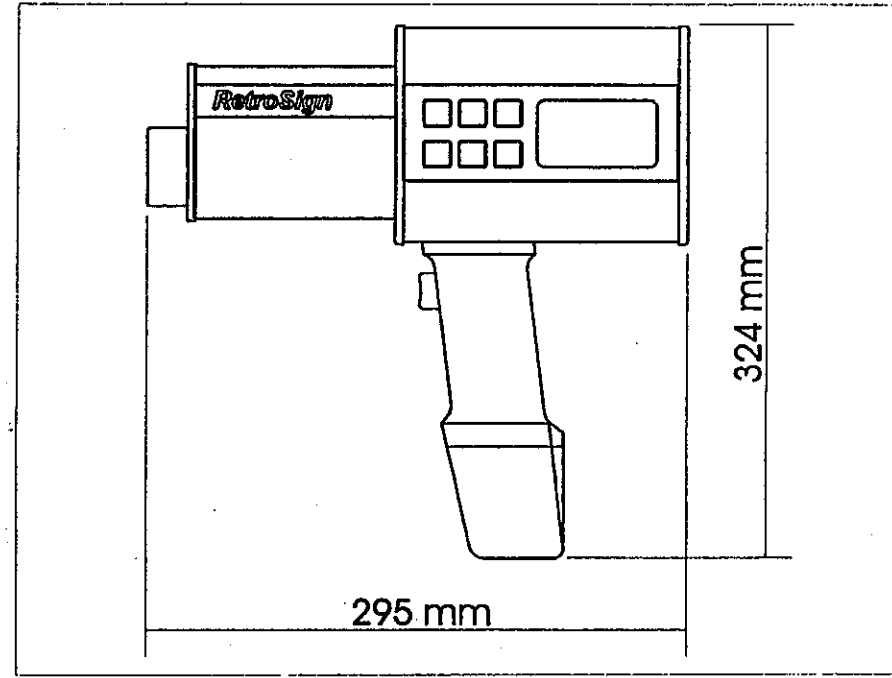

RetroSign dimensions

SECTION 3	3-1
GENERAL INFORMATION	3-1
RetroSign®	3-1
Factory calibrations	3-1
Type 4000	3-2
Type 4500	3-3
Battery	3-4
Note on error sources	3-4
SECTION 4	4-1
MAINTENANCE	4-1
General care	4-1
Front lens	4-1
Battery	4-1
Lamp	4-2
Reference cap	4-2
Calibration	4-3
APPENDIX A	A-1
COMMUNICATION FACILITIES	A-1
RS-232C specification	A-1
Data protocol	A-1
Command format	A-1
Example	A-2
Command set	A-2
APPENDIX B	B-1
SPECIFICATIONS	B-1
General characteristics	B-1
Electrical characteristics	B-2
Environmental characteristics	B-2
Mechanical characteristics	B-2
Dimensional drawings	B-3

SECTION 1

INTRODUCTION

Electrical characteristics

EMC	EN 50081-1 EN 50082-1
Power supply:	
Battery	Replaceable NiCd 9.6 V / 1.2Ah Bosch part number: 2 607 335 012
External charger	Mains voltage 230 VAC Optional: 110V / 60Hz
Charge time	Approx. 15 minutes
Data memory	1000 measurements
Data retention (from purchase)	Typ. 5 years
Interface	RS 232
Serial communication mode	9600,N,8,1

Environmental characteristics

Temperature:	0°C to + 45°C 32°F to 113°F
Humidity	Non condensing

Mechanical characteristics

Length	295 mm / 11.6 in
Width	83 mm / 3.3 in
Height	324 mm / 12.8 in
Weight	2,1 kg / 4.6 lbs
Gross weight	Approx. 6 kg / 13.2 lbs

RetroSign® introduction

The RetroSign retrometer is a portable field instrument, intended for measuring the retroreflection properties of road signs in car headlight illumination. The value R' (coefficient of retroreflected luminance) is used. R' is a measure of the lightness of the road signs as seen by drivers of motorized vehicles in headlight illumination. RetroSign is available in different versions. For type 4000 the sign is illuminated at an angle of +5° and the angle between illumination and observation is 0.33°. For type 4500 the sign is illuminated at an angle of +5° and the angle between illumination and observation is 0.33°. This corresponds to an observation distance of 100 metres. Thus, relevant for a motorist viewing situation under normal conditions.

R' is an important factor in the on-site quality control of road signs!

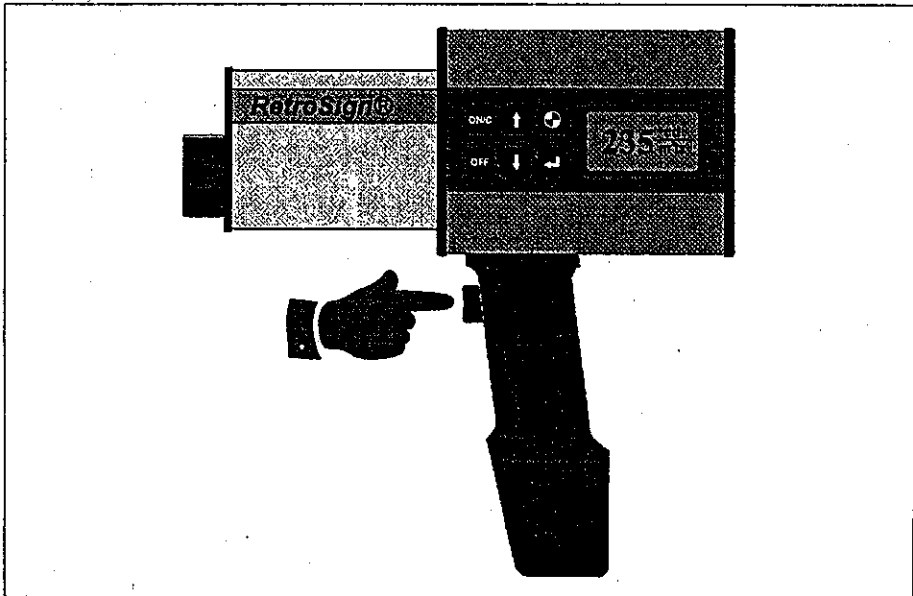

DELTA RetroSign Retrometer

The operation of the retrometer is very simple and requires a minimum of instruction. An error or warning message is given in case of unreliable or erroneous measurement.

The RetroSign measures the retroreflection and calculates R' according to international agreements. Results are presented on a LCD panel. The non-volatile memory provides on site registration of measurements with corresponding date and time.

RetroSign has a built in function to mark each measurement with a user defined name (measurement id) and a unique sequence number.

Data communication on RS232 port gives extended command, calibration, diagnostics and data dump facilities.

The RetroSign is powered by a rechargeable battery, giving several hours of measurement capacity. A mains powered battery charger is supplied as standard.

RetroSign retrometer features

- Portable self-contained instrument
- Measurement in full daylight
- Photopic corrected detector and source "A"
- Automatic stray light compensation and error diagnostics
- Measurement geometry and illumination corresponding to realistic viewing condition in night time traffic
- Direct digital read out
- Real time clock
- Automatic data storage in internal non-volatile memory
- RS232 serial communication for operation, data dump, extended control and diagnostics
- Communication cable
- Long battery life
- 230 V / 50 Hz or 120 V / 60 Hz mains powered battery charger

APPENDIX B

SPECIFICATIONS

General characteristics

Type 4000:

Geometry DIN 67520: 5°/0.33

Illumination angle +

Illumination / observation angle 0.33

Light source angular aperture 0.16

Receptor angular aperture 0.16

Type 4500:

Geometry ASTM-E-1709: -4°/0.2

Illumination angle -4

Illumination / observation angle 0.2

Light source angular aperture 0.1

Receptor angular aperture 0.1

Type 4000 / 4500:

Field of measurement ø 30 mm / 1.2

Light source Illuminant "A"

Receptor sensitivity Precise eye correct
(ASTM-E-1709 para. 6.4.2 for selected color filter)

Min. reading (cd/lx·m²)

Max. reading (cd/lx·m²) Typ. 20

- Automatic programmable power off function
- Easy calibration procedure
- Reference cap for calibration
- Carrying case (foam lined)

Options

- Extension pole kit
- Fast 12V powered battery charger (approx. 15 minutes)
- Battery (extra)

RZ	RetroSign Zero calibration. <i>RZ</i> is a part of the instrument calibration procedure. Use <i>RZ</i> on the reference cap's zero standard. Confirm with <Y>. Must be succeeded by the <i>RC</i> -command.
SN [nnnnnn]	Sequence id text. Maximum 6 characters including spaces. 6 spaces disables the sequence id text.
SD	Status Dump. Returns instrument status. All settings and values are displayed. Used for verification and trouble shooting.
TI [hh mm ss]	Set Time in real time watch. <i>TI</i> without parameter returns current date and time from real time watch.
TO	Turn RetroSign Off immediately. Same as pressing OFF button on keyboard.
TX [T/F]	Text mode True/False. If <i>TX</i> is true RetroSign will return information to the serial port in plain English. At instrument power on <i>TX</i> will always be false.
VA	Voltage Alarm. Returns set point for low battery warning icon.
VB	Voltage Battery. Returns actual battery voltage.
VS	Voltage Status. Returns battery voltage with and without lamp switch on. Returned values are from last time lamp was switched on.
?	Returns help menu.

50 5 will respond like this:

```
50 ,1996-07-25 11:15:00 ,210 ,0 ,xyz-a,34
51 ,1996-07-25 11:17:00 ,180 ,0 ,xyz-a,35
52 ,1996-07-25 11:20:00 ,302 ,0 ,xyz-a,36
53 ,1996-07-25 12:00:00 ,210 ,3
54 ,1996-07-25 13:15:00 ,235 ,3 ,xyz-a,37
End of Log File
```

A log dump can be terminated by any key.

Log Open.

Activates the built-in log for storing measuring and calibration data. Measuring number, date, time, R', mode and sequence id are logged. Only valid measurements and calibrations are logged.

Log Reset.

Deletes all stored data. Log must be open. Confirm with <Y>.

Log Stop.

Closes log. Measuring data is no longer logged.

Auto Off Timer n=seconds (0..599 sec.).

Sets the time for automatic instrument turn off. n < 60 disables the automatic off timer.

RetroSign Calibration. Use RC on the reference standard. n=calibration value from the reference standard. RC without parameter returns the calibration value (n).

R' Measurement.

Executes measurement cycle. Returns R'. Same as using instrument trigger.

Read R'.

Returns result of last RM-command.

SECTION 2

OPERATING INFORMATION

Getting started

Turn the RetroSign on by pressing **ON/C**.

After approx. 2 seconds the display will show:

Calibrate instrument if necessary, see calibration.



Icons

Instrument status and operational mode are signalled by the use of icons. Icons are shown in the top line of the display.

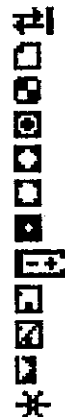

Instrument is calibrated and ready.

Menu selected.

Calibration selected.

Zero calibration in progress.

Reference calibration in progress.

Calibration Monitor Active for normal aperture

Calibration Monitor Disable for reduced aperture

Battery low warning.

Log is enabled.

Log is full.

Sensor is receiving data on the serial communication port.

Display backlight is on.

When  is active the instrument is calibrated and ready for use.

Start a measurement by pressing the red trigger knob on the handle. A beep indicates the start of the active measuring cycle. The display shows an hourglass for the duration of the measurement, approx. 3 seconds. A new beep signals the end of the measurement.

If any errors are detected during the measurement or calibration sequence, an error icon and error number is shown.

See also Section 3 - Note on error sources.

Sequence id

RetroSign has a built in function to mark each measurement with a user defined name (sequence id) and a unique sequence number automatic generated by the instrument. The sequence id and the sequence number will also be stored in the log. The length of the sequence id text is 6 characters. See *Menu system*.

Keyboard functions

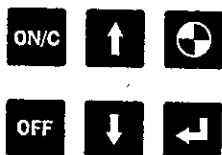

ON / Clear

- Push shortly to switch on instrument.
- When switched on it clears the current operations.
- Redisplays the last measuring result.

OFF

- Turn off RetroSign.



- Activate menu system.
- Scroll key when in menu system.
- Parameter and value increment / decrement.



Calibration

- Activate menu for instrument calibration.



Enter

- Activate selected function or accept changed settings.

Trig

- Start R' measurement.
- Start fast calibration.

Calibration

RetroSign features two levels of calibration: *fast* and *full*.

Fast calibration is an "everyday" calibration using factory zero calibration and default reference value. Default reference value can be changed only when

II

Initialise Instrument settings. Confirm with <Y>.
Sets instrument to factory settings. Calibration is necessary.

LA

Lamp current Alarm.
Returns set point for low lamp current alarm.

LC

Lamp Current.
Returns the lamp current measurement from the last RM

LD [n1 n2]

Log Dump.
Returns measuring number, date, time, R', mode and sequence id. Each value are separated by comma. Data can easily be imported in a spreadsheet e.g. Microsoft Excel.

LD without parameters will respond like this:

```
1,1996-07-30 08:22:53 ,200 ,0 ,Roadxy,1
2,1996-07-30 08:23:42 ,385 ,0 ,Roadxy,2
3,1996-07-30 08:26:58 ,210 ,2
4,1996-07-30 08:27:58 ,296 ,0 ,Roadxy,3
End of Log File
```

Column 1 = measurement number, 2 = date/time of measurement, 3 = measured value, 4 = mode, 5 = sequence id (if any).

Mode indicates what kind of measurement was executed. 0 = normal measurement, 1 = fast calibration, 2 = full calibration, 3 = calibration via communication port (RC command).

Including parameters to the *LD* command specify the log start number and the length (numbers of lines). If n2 are omitted data starts from log position n1 and to the end of the log file.

RetroSign can respond to a command in two ways: *data mode* or *text mode*. RetroSign always powers up in the *data mode*. This mode is used by the *RSC-Ad Sensor Control* program.

A special command, *TXT*, is used to set RetroSign to respond in *text mode*. The user should set RetroSign to respond in *text mode* if a simple communication program is used instead of the RSC program.

Example

If the user wants to set the automatic off timer to 120 seconds.

The command should look like this:

OT 120 <CR> or **OT120<CR>**

If the RetroSign accepts the command it responds:

120

In *text mode* it responds with the message:

Automatic Off Timer = 120 sec.

If for some reason the communication fails or the command is rejected RetroSign responds with a question mark <?>.

If the parameter exceeds the defined range for that parameter, RetroSign returns the present setting without any change.

Command set

The following command actions are all

Command:	Action:
B [T/F]	Display Backlight True/False. True enables display light. False disables light.
DA [yyyy mm dd]	Set year, month, date in real time watch. DA without parameter returns current date and time from watch.
V	Returns Firmware Version.



using the *full* calibration mode.

Full calibration is used for high accuracy calibration of zero and reference.

• Fast calibration.

Fast calibration is initiated by pressing  and then trigger. Mount *reference cap* (reflective bottom) before triggering. Calibration is executed immediately. Default instrument zero (factory setting) is used.



• Full calibration.

Full calibration is initiated by pressing  and . Follow the procedure displayed.

Zero.

Mount the *zero cap* (dark bottom) on the instrument. Press  when ready. When hourglass disappears instrument is ready for next step in the calibration procedure.

Reference.

Mount the *reference cap* (reflective bottom). Edit reference value using   until correct.

Press  when ready.

When the hourglass disappears confirm with  when ready. Cancel with **ON/C**.





After a successful calibration the  icon is active.

If for some reason the calibration fails, values from the previous successful calibration are used. This information is given immediately after calibration.

Reduced Aperture option.

When the instrument is configured for measurements with reduced aperture the calibration monitor should be disabled to avoid the "Error in Calibration" condition, the display icons reflect the status for this option.

Menu system

Press  or  to activate the menu system from top or bottom end respectively. When menu is selected use  and  to scroll through function. To select the shown function press .

Menu points are:

- **Remove top data in log.**
This function allows the user to delete the top level in the data log. The deletion restores the *Sequence ID* text string and measurement counter from the log. The deletion process can be continued until the log is empty. Deleted data cannot be recalled.
- **Data log enable / disable. (Log Open).**
Switches on / off the built-in data logger. Press **←** to toggle selection. When the log is enabled the **□** is shown and the bottom display line will show the number of measurements stored in the log and date / time for the last log entry. When the log is full the **▣** is shown and log stops.
- **Data log clearing. (Free data log).**
Clears built in data log. Also shows the remaining space in the log in percent. Press **←** to clear data log.
- **Off time (power save).**
Settings for automatic instrument power off. When selected use **↑** and **↓** to edit off time. Off time less than 60 sec. will disable automatic power off!
- **Initialize instrument.**
Initialize the instrument to factory default settings. The instrument has to be calibrated afterwards. The log data and sequence id are not affected but the log is closed afterwards.
- **Display light.**
Enables or disables the display back light. Press **←** to toggle operation. When display light is enabled the **✱** is shown. The back light will light for a moment when any key or measurement trigger are pushed.
- **Clear Seq_ID.**
Clears the sequence id as if all 6 positions were set to space. Press **←** to clear. *See also Sequence ID.*
- **Sequence ID. (Old Seq_ID)**
If any sequence id is defined, the id text and a sequence number is shown

APPENDIX A

COMMUNICATION FACILITIES

RS-232C specification

The RetroSign is equipped with a communication facility that enables the use of a simple terminal or an ordinary PC type computer for control of the RetroSign functions and for dump of data from the internal data log.

The computer or terminal connects to the RetroSign using the connector on the rear and a special communication cable. The cable is mounted with a 9 pin female connector for computer connection. Use of a 9 to 25 pin adaptor may be necessary on some computers.

The electrical connections meet the normal standard for serial communication.

Data protocol

The communication between the RetroSign and the computer equipment takes place using the following settings:

Baudrate 9600 bit/sec
 Number of databit
 Parity no
 Stopbit

Command format

All RetroSign commands are build using the following template.

Command	Letters (not case sensitive) or <?>.
Delimiter	One or more spaces, optional.
Parameter	One or more integer or real numbers seperated by spaces, optional. Parameters in square brackets are optional. If no parameters are entered the actual value is returned.
Delimiter	One or more spaces, optional.
Command end	Carriage Return (<CR>), mandatory.

in the display. To edit the sequence id press the \leftarrow button. The \leftarrow cursor is placed to the right of the first character position. Use the \uparrow button to scroll through the alphabet in direction 0..9,A..Z starting with the space character. The \downarrow button will scroll through the alphabet in opposite direction. When the wanted character is shown press the \leftarrow button to advance to the next position. You have to step through all 6 positions before the sequence id function can be accepted.

When typing a new sequence id text or editing an old one, the sequence number is reset to 0. When all 6 positions are set to space the sequence id function is undefined and no longer included in the log nor shown in the display.

Battery / charging

Temperatures in excess of 50°C (122°F) will damage the battery. Do not short circuit. Do not dispose with household waste.

To remove battery swing over battery retaining spring and pull out battery from handle. *See Section 4 - Battery* for further information on charging.

Remote control

External trigger.

By use of the connector on the rear of the instrument, it is possible to remote trigger the instrument.

Serial communication.

The instrument is equipped with a serial communication port. This allows complete instrument control and data collection.

Use a simple terminal or PC with communication software to control the RetroSign.

Serial communication setup (RS232 interface):

9600 baud, No parity, 8 bit, 1 stop bit

Selected commands.

LO \leftarrow	(Log Open):	Enables log for input.
LD \leftarrow	(Log Dump):	Number, date, time, R', mode.
RM \leftarrow	(R' Measurement):	Start R' measurement.
SD \leftarrow	(Status Dump):	Returns instrument settings and status.

On-line help.

? ←

RetroSign will return a brief help page of command set.

See also *Appendix A - Communication facilities.*

- * RetroSign is an optical precision instrument. handle with care.
- * Store in clean and dry environment.
- * Do not recharge after using only briefly.
- * Check or change *reference cap* frequently.

Aperture Reduction.

For special measurement requirements on small targets, the Retrosign can be mounted with a special Aperture Reducer Unit, this reduces the field of measurement to either \varnothing 15 mm (0.6 in) or \varnothing 10 mm (0.4 in) depending on the unit used.

To achieve the smaller aperture, the reduction unit is simply mounted in front of the lens barrel.

There is however one drawback in using the aperture reduction unit! The signal values obtained during the calibration procedure will be much smaller than originally anticipated, this and the fact that the instrument default is set to interpret low signal values during calibration as an error condition, will render the calibration useless and not allowing the user to make any measurements.

To avoid this situation, instrument with firmware version 1.28 and higher have a new menu feature that controls the error monitor function.

Disable the Calibration Monitor when using the Reducer!

periodically recalibrated to a traceable standard. DELTA Light & Optics offer calibration traceable to PTB (Physikalsich-Technische Bundesanstalt). For information contact your distributor or DELTA Light & Optics, Denmark.

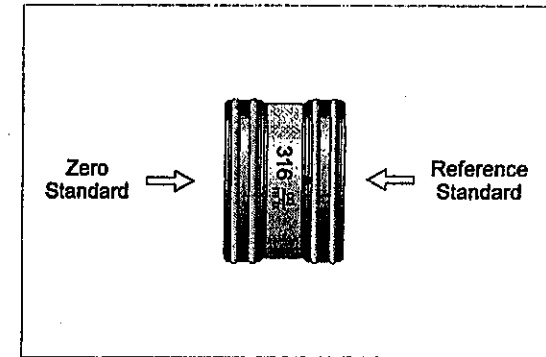

Reference cap

Calibration

The RetroSign is factory calibrated, but a calibration should always be carried out before starting a series of measurements.

After compensation of zero signal, leakage and other known "errors" the calibration factor is easily calculated. This is done **automatically** by the instrument if the calibration routine is followed. After a calibration the retrometer will display "true" R'.

Store the reference cap in a dry and clean environment.

See also *Section 2 - Getting started and Section 3 - General information.*

SECTION 4

MAINTENANCE

General care

The retrometer is constructed for outdoor use in ordinary good weather conditions. It will withstand moist weather, but caution must be taken against rain or splashes and dirt from traffic. The RetroSign retrometer is an optical instrument and shall be handled as such. Avoid shock and vibration if possible.

Front lens

The lens does not need special maintenance. If dirty carefully moist the lens with ordinary window cleaning liquid and clean it with a soft cloth.

Battery

The instrument is powered by a Ni-Cd battery, which under normal use requires no maintenance.

A battery charger is provided as a standard accessory for charging the battery from mains.

To recharge the battery swing over battery retaining spring and remove battery from the handle.

Please refer to enclosed charger instructions for operation and for details of charging process.

A new battery or one which has not been used for an extended period achieves full performance only after approx. 5 charging and discharging cycles.

The battery is equipped with a temperature monitor which allows charging only within a range between 0°C and 45°C (32°F and 113°F). This ensures long battery life. When used properly, the battery can be recharged up to 10 times.

A substantial drop in operation period per charge indicates that the battery is worn out and must be renewed.

Battery and charger are specifically designed for use in conjunction with o

Other. Charging should be performed exclusively with the charger delivered with the instrument.

Do not expose battery to heat or flames: **Danger of explosion.** Do not place battery on a heater or expose to direct sunlight for long periods. Temperatures in excess of 50°C (122°F) will damage the battery. Allow warm battery to cool before charging. When battery is outside the instrument, cover the contacts to avoid short circuits.

Avoid repeated consecutive rapid charges of the battery. Do not recharge after charging only briefly.

Note

Battery should be protected against impact. Do not open battery. Store battery in a dry place where it is protected against freezing. Due to environmental protection do not dispose battery with household waste.

Lamp

The lamp requires no maintenance. At life end the instrument will display a lamp error and the lamp must be renewed. It is recommended that renewing is done by trained personal.

Reference cap

To make sure that the calibration of the retrometer is correct it is important that the surface on the reference cap is clean and undamaged. Keep the cap protected, and be aware of that you don't touch the reference cap (reflective bottom).

If the surface is stained, scratched or broken the reference cap has to be replaced.

In case of dust on the surface, clean it gently by use of a soft cloth with a mild household detergent. Wipe carefully with dry cloth afterwards.

To ensure reliable measurements, it is recommended that the reference cap is

Disabling the Calibration Monitor:

Press the ↑ or ↓ until the display shows
Calibration Monitor ON
Disable Now

Press ← to Disable.

Enabling the Calibration Monitor:

Press the ↑ or ↓ until the display shows
Calibration Monitor OFF
Enable Now

Press ← to Enable.

Be aware that the state of the Calibration Monitor normally cannot be seen in the display!

Sequence ID

From firmware version 1.28 the valid range for the Sequence ID has been reduced to only allow for the space character, numbers and the capital letters A to Z.

SECTION 3

GENERAL INFORMATION

Battery

The RetroSign is powered by a replaceable rechargeable battery, which under normal operation will keep the retrometer operating a day. The battery must be recharged by an external charger. See also *Section 4 - Battery*.

Note on error sources

The RetroSign is factory calibrated. Nevertheless, begin important measurements sessions with a calibration. See also *Section 4 - Maintenance*.

During measurements RetroSign must be in close contact with the surface of the sign.

Any light can enter the instrument between front-end and the sign. Leakage will under normal conditions not be significant. Nevertheless, it may occur. During each measurement the RetroSign automatically evaluates the leakage. The result is compensated before read out.

Instrument leak, drift and offset errors are compensated by means of data obtained during the calibration procedure, so perform calibration procedure carefully. It is very important to keep front lens and surface on reference cap clean.

Values from measurements on wet signs are **not** reliable.

The RetroSign retrometer is a rugged instrument, but it is an optical instrument and must be handled as such.

Store instrument in a clean and dry environment.

RetroSign®

RetroSign retrometer measures the R' (coefficient of retroreflected luminance) parameter. The R' parameter represents the retroreflection of the road signs seen by drivers of motor vehicles by headlight illumination.

Physically the retrometer is a small hand held instrument. It is constructed in aluminum housings, containing electronics and the optical system. The measurement trigger button and the replaceable battery are housed in the handle.

The RetroSign is controlled by a microcontroller. The microcontroller executes a measurement automatically when the trigger is activated and the result is shown on the display. The result is automatically transferred to the internal non-volatile memory if logging is enabled. The RetroSign is operated from a small keyboard on the lefthand side of the retrometer. Retrometer control is also possible by a serial communication link (RS 232). Stored data can be transferred to a PC for further processing.

Factory calibrations

The RetroSign retrometer is factory calibrated. This calibration is carried out by using a special reference. The reference's R' value is measured in the laboratory using traceable methods and equipment.

The enclosed reference cap can be used for verification or recalibration of the retrometer.

Type 4000

In the RetroSign the illumination angle is $+5^\circ$ and the offset between observation and illumination angle is 0.33° . The measurement area is approx. $\varnothing 30$ mm.

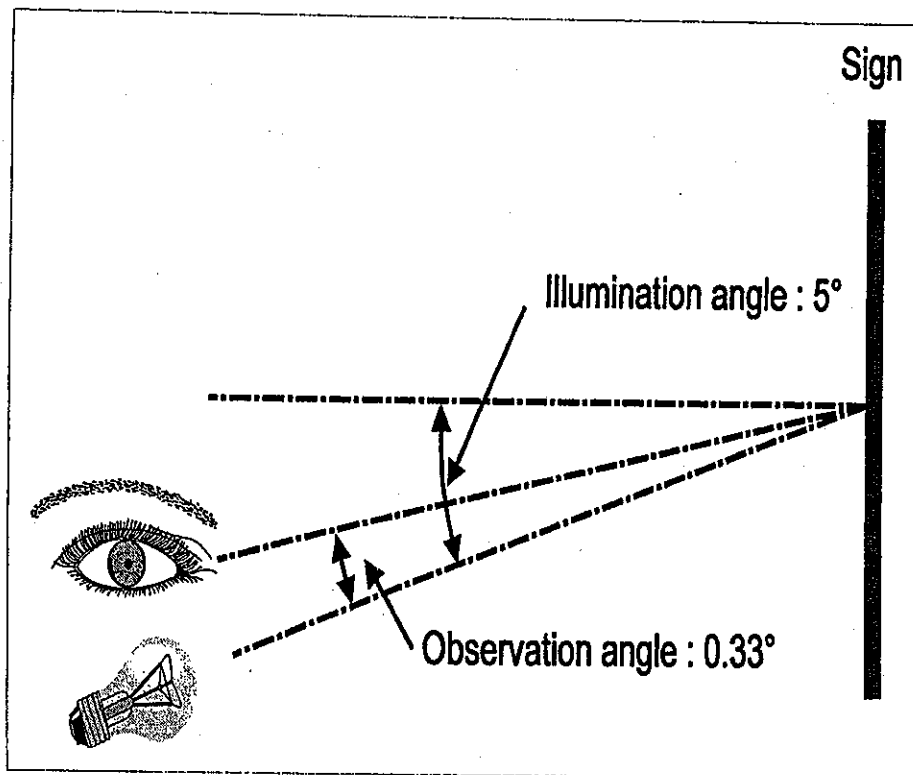

Type 4500

In the RetroSign the illumination angle is -4° and the offset between observation and illumination angle is 0.2° . The measurement area is approx. $\varnothing 30$ mm. Or $\varnothing 15$ mm/ $\varnothing 10$ mm when using the reduced aperture adaptor. According to ASTM R' is named RA.

