



**ALASKA DEPARTMENT OF TRANSPORTATION**

**Evaluation of Overheight Vehicle  
Warning Devices**

Prepared by: Stephen P. Mattingly  
Department of Civil and Environmental Engineering  
Transportation Research Center  
Institute of Northern Engineering  
University of Alaska Fairbanks  
P. O. Box 755900  
Fairbanks, Alaska 99775

**Date** July 8, 2003

**Prepared for:**  
Alaska Department of Transportation  
Statewide Research Office  
3132 Channel Drive  
Juneau, AK 99801-7898

FHWA-AK-RD-03-02

Alaska Department of Transportation & Public Facilities  
**Research & Technology Transfer**

# REPORT DOCUMENTATION PAGE

Form Approved OMB No. 0704-0188

Public reporting burden for this collection of information is estimated to average 1 hour per response, including the time for reviewing instructions, searching existing data sources, gathering and maintaining the data needed, and completing and reviewing the collection of information. Send comments regarding this burden estimate or any other aspect of this collection of information, including suggestions for reducing this burden, to Washington Headquarters Services, Directorate for Information Operations and Reports, 1215 Jefferson Davis Highway, Suite 1204, Arlington, VA 22202-4302, and to the Office of Management and Budget, Paperwork Reduction Project (0704-0188), Washington, DC 20503.

1. AGENCY USE ONLY (Leave blank)		2. REPORT DATE July 8, 2003		3. REPORT TYPE & DATES COVERED Final September 2001 – June 2003	
4. TITLE AND SUBTITLE Evaluation of Overheight Vehicle Warning Devices				5. FUNDING NUMBERS DOT-01-013	
6. AUTHOR(S) Stephen P. Mattingly					
7. PERFORMING ORGANIZATION NAME(S) AND ADDRESS(ES) Department of Civil and Environmental Engineering Transportation Research Center Institute of Northern Engineering University of Alaska Fairbanks P. O. Box 755900 Fairbanks, Alaska 99775				8. PERFORMING ORGANIZATION REPORT NUMBER	
9. SPONSORING/MONITORING AGENCY NAME(S) AND ADDRESS(ES) Alaska Department of Transportation Statewide Research Office 3132 Channel Drive Juneau, AK 99801-7898				10. SPONSORING OR MONITORING AGENCY REPORT NUMBER  FHWA-AK-RD-03-02	
11. SUPPLEMENTARY NOTES					
12a. DISTRIBUTION/AVAILABILITY				12b. DISTRIBUTION CODE	
13. ABSTRACT (Maximum 200 words)  Overheight loads pose a significant hazard to the infrastructure. Tunnels, bridges and overpasses are struck around the United States by unpermitted and permitted vehicles. Frequently, damage to the infrastructure is significant enough to require repair, which may be quite extensive and expensive. Each state Department of Transportation (DOT) may select a variety of strategies to try to mitigate these crashes. Many DOTs focus on effective routing strategies for permitted vehicles; however, at times routing errors may occur. Furthermore, drivers may actually disregard the routing instructions. These concerns make the need for redundancy within the system more critical. Through a directed survey with twenty-nine responding DOTs, this report examines the strategies for redundancy in the system to improve safety and reduce maintenance costs. These strategies include passive and active systems, which receive the primary focus of this report (including two specific existing systems), as well as more legislative and administrative protections beyond the permitting and routing procedures, which this report considers briefly. A lack of definitive data exists regarding the effectiveness of these techniques exists; however, qualitative assessments from DOTs combined with the costs associated with each solution to present an accurate picture of their current practices.					
14. SUBJECT TERMS Vehicle Detectors, Oversize, Protection, Hazards, Warning Systems, Warning Signs,				15. NUMBER OF PAGES	
				16. PRICE CODE	
17. SECURITY CLASSIFICATION OF REPORT  Unclassified	17. SECURITY CLASSIFICATION OF THIS PAGE  Unclassified	18. SECURITY CLASSIFICATION OF ABSTRACT  Unclassified	19. LIMITATION OF ABSTRACT		

# EVALUATION OF OVERHEIGHT VEHICLE WARNING DEVICES

## FINAL REPORT

Prepared for  
Alaska Department of Transportation & Public Facilities

### **Principal Investigator**

Stephen P. Mattingly, Assistant Professor

Department of Civil and Environmental Engineering  
Transportation Research Center  
Institute of Northern Engineering  
University of Alaska Fairbanks  
P. O. Box 755900  
Fairbanks, Alaska 99775

Report # FHWA-AK-RD-02-12  
June 2003

# TABLE OF CONTENTS

<b>TABLE OF CONTENTS</b>	<b>i</b>
<b>LIST OF FIGURES</b>	<b>ii</b>
<b>LIST OF TABLES</b>	<b>iii</b>
<b>ACKNOWLEDGEMENTS</b>	<b>iv</b>
<b>SUMMARY OF FINDINGS</b>	<b>1</b>
<b>CHAPTER 1 – INTRODUCTION AND RESEARCH APPROACH</b>	<b>2</b>
1.1    PROBLEM STATEMENT AND RESEARCH OBJECTIVE	2
1.2    SCOPE OF STUDY	2
1.3    RESEARCH APPROACH	3
<b>CHAPTER 2 – FINDINGS</b>	<b>4</b>
2.1    STATE-OF-THE-ART SUMMARY	4
2.2    VENDOR SURVEY RESULTS	5
2.3    STATE DOT SURVEY RESULTS	6
2.4    ALASKA RAILROAD	8
2.5    SITE VISITS	9
2.5.1 <i>Pennsylvania</i>	9
2.5.2 <i>California</i>	13
<b>CHAPTER 3 - INTERPRETATION, APPRAISAL, AND APPLICATIONS</b>	<b>16</b>
3.1    IMPLICATIONS OF SURVEY AND ANALYSIS	16
3.2    GENERAL RECOMMENDATIONS	16
<b>CHAPTER 4 - SUGGESTED RESEARCH</b>	<b>17</b>
<b>APPENDIX A – COMPLETE STUDY RESULTS</b>	<b>19</b>
<b>APPENDIX B – VENDOR PRODUCT AND CONTACT INFORMATION</b>	<b>22</b>
<b>APPENDIX C – SITE VISIT QUESTIONNAIRE</b>	<b>87</b>
<b>APPENDIX D – SITE VISIT DETAILS</b>	<b>89</b>

## LIST OF FIGURES

	Page
Figure 2.1 Effectiveness of EWDS	7
Figure 2.2 Number of Infrastructure Strikes in States Without EWDS	8
Figure 2.3 Laser Overheight Detector	10
Figure 2.4 Upstream Laser Overheight Detector on a Standard Pole	10
Figure 2.5 Responsive Message Sign Directing Overheight Vehicles to Exit	11
Figure 2.6 Active Warning Sign	12
Figure 2.7 Traffic Signals for Stopping Freeway Traffic	12
Figure 2.8 Detector System at Castaic Weigh Station (California)	13
Figure 2.9 Control Panel at Castaic Weigh Station (California)	14
Figure 2.10 Detector System at Otay Mesa Weigh Station (California)	14

## LIST OF TABLES

	Page
Table I Comparison of Strategies to Reduce Infrastructure Collisions	1
Table 2.1 Vendor Survey Results	5
Table 2.2 Survey Results for States With EWDS	6

## ACKNOWLEDGEMENTS

The Transportation Research Center, Institute of Northern Engineering, University of Alaska-Fairbanks (UAF) conducted this research under Alaska DOT&PF Project DOT-01-13: *Evaluation of Overheight Vehicle Warning Devices*. Stephen P. Mattingly, Assistant Professor of Civil and Environmental Engineering, served as the principal investigator and authored this report with the assistance of Kathryn Knorr, Student Assistant, UAF and Jason Sakalaskas, Student Assistant, UAF. Scott Thomas, Traffic Engineer, and Walt Luebke, Maintenance Manager, both of Alaska DOT&PF provided critical assistance in developing the questionnaire for the site visit. Additionally, Mr. Luebke traveled with the author for the site visits to California and Pennsylvania. Billy Connor, Research Manager, Alaska DOT&PF and Clint Adler, Research Engineer, Alaska DOT&PF, provided project management and guidance.

## **ABSTRACT**

Overheight loads pose a significant hazard to the infrastructure that they must pass under and through. Tunnels, bridges and overpasses are struck around the entire United States by both unpermitted and permitted vehicles. Frequently, the damage to the infrastructure is significant enough to require repair, which may be quite extensive and expensive. Each state Department of Transportation (DOT) may select a variety of strategies to try to mitigate these crashes. Many state DOTs focus on effective routing strategies for permitted vehicles; however, at times routing errors may still occur. Furthermore, drivers may actually disregard the routing instructions or fail to follow them due to an error. These concerns make the need for redundancy within the system more critical.

Through a directed survey with twenty-nine responding state DOTs, this report examines the strategies that a state DOT may select to create this redundancy in the system to improve safety and reduce maintenance costs. These strategies include passive and active systems, which receive the primary focus of this report (including two specific existing systems), as well as more legislative and administrative protections beyond the permitting and routing procedures, which this report considers briefly as a parallel solution approach. A lack of definitive data exists regarding the effectiveness of these techniques exists; however, qualitative assessments from state DOTs are combined with the costs associated with each solution to present an accurate picture of their current practices.



## SUMMARY OF FINDINGS

Table I summarizes this findings from this study. While the laser and infrared systems with signs, seem to be the most effective. No system appears to be perfect. None of these systems appear to have high maintenance and operating costs; therefore, this does not pose a deterrent to implementing one system over another. At this time, a laser or infrastructure system seems to be a good choice if the power requirements can be overcome; however, human error still has a high likelihood of circumventing this mitigation approach. For the long-term, a technological solution coupled with implementing a police escort for overheight vehicles, improved enforcement and increased penalties may serve as the best approach to reduce collisions at the point of contact and increase the deterrent to their occurrence in the first place.

**Table I. Comparison of Strategies to Reduce Infrastructure Collisions**

<b>Solution</b>	<b>Power Req'd</b>	<b>Initial Cost</b>	<b>Annual M&amp;O Costs</b>	<b>Assessed Effectiveness</b>	<b>Problems</b>
Warning signs and lights	Yes	\$ 0.2-3K	\$200-500	Unknown	Unknown
Passive-rigid	No	\$ 2-20K	\$0-500	Slight reduction	Possible damage to truck and other nearby vehicles
Passive-nonrigid	No	\$ 2-35K	\$0-500	Slight reduction	Inaudible over road noise for drivers
Laser/Infrared w/signs	Yes	\$ 7-70K	\$0.2-1.5K	Reduction	False positives
Enforcement/Penalties	No	Unknown	Unknown	Unknown	Unknown
Police Escort	No	Unknown	Unknown	Unknown	Still prone to human error

## **CHAPTER 1 – INTRODUCTION AND RESEARCH APPROACH**

### **1.1 Problem Statement and Research Objective**

Overheight loads have struck bridges throughout the Anchorage Bowl and along the Glenn Highway. Specifically, the bridge overpass at Eklutna Interchange on the Glenn highway has been struck numerous times over the past years, more noticeably than most other bridges. Eventually, the bridge sustained enough damage to warrant repair; the Alaska Department of Transportation and Public Facilities (DOT&PF) has recently repaired the cracks and spalls across the lower reinforced concrete girders. Bridge repairs are expensive, but also require the closure of the main freeway, which forces traffic onto the interchange ramps. Other bridges along the Glenn Highway are also struck at times and some are lower than the Eklutna Bridge. Similarly, the Anchorage Bowl has some lower bridges that may also be struck. The Alaska Department of Transportation and Public Facilities (DOT&PF) needs to identify potential mitigation options. Although Alaska DOT&PF knows of infrared detection and warning signs to alert and reroute overheight trucks, they have concerns that such a device can function in Alaska's extreme cold weather conditions. Overall, they lack information regarding potential solutions, specifically measures of effectiveness and costs.

The Eklutna Bridge has recently been struck again chipping off some more concrete. Girder damage accumulates over time and eventually leads to more expensive repairs and disruptive traffic closures. If the Alaska DOT&PF does not implement a mitigation scheme, then they will continue to experience a high frequency of bridge strikes and possibly need to consider replacing rather than repairing girders on some bridges. While a single measure may not eliminate all bridge strikes, an effective strategy has the potential to significantly impact the frequency of the incidents. Reducing bridge strikes will save on repair and traffic control costs to Alaska DOT&PF's Maintenance and Operations (M&O) Division, which frees up funds for other problems. Although some funds will be required to maintain an overheight detection system, preventative maintenance is usually cheaper than damage control. The ultimate goal of this study is to provide Alaska DOT&PF with a comprehensive synthesis of the state-of-the-practice in oversize vehicle warning devices to assist the Alaska DOT&PF in the development of a new methodology for reducing these vehicles collisions with bridges.

### **1.2 Scope of Study**

This project explored state-of-the-practice techniques across the United States for mitigating overheight truck collisions with bridges. The research team attempted to directly contact the forty-nine states excluding Alaska. Of the forty-nine contacted, this study received responses from twenty-nine states, a fifty-nine percent response rate. In some cases, the states failed to provide requested information and the proper survey respondent could not be identified for others. In some cases, the survey respondent may not have had complete knowledge of existing facilities. This research considered vendor

input to gain further insight into selected alternatives. This study paid particular attention to collecting information regarding other states' experiences with operations under environmental conditions similar to Alaska. This research effort focuses on existing oversized warning systems, their success rate and costs (capital, operating, and maintenance); however, this project discovered that very little of this data exists formally.

### **1.3 Research Approach**

This research attempts to synthesize existing data and previous research to develop a comprehensive examination of the state-of-the-practice for oversized vehicle warning devices. The lack of primary data sources and previous research requires much of the analysis to rely on anecdotal data and qualitative assessments. This research does not consider new state-of-the-art solutions because they may remain unproven, especially under Alaskan conditions. This study seeks to provide the Alaska DOT&PF with guidance in the development of a new methodology for reducing these vehicles collisions with bridges.

The Alaska DOT&PF is primarily interested in each method's performance and success in reducing bridge strikes. Therefore, this study attempts to gather data for the following performance measures: the operating and maintenance costs, the reduction in bridge strikes, the liability issues, the ease of installation and the vehicle speeds. After identifying specific performance measures of interest, this study conducts telephone interviews with thirty-one state departments of transportation (DOTs) to try to gather data to assess these measures. Additionally, installation cost data and information regarding operational difficulties, such as effectiveness in extreme weather conditions, are collected. Some of this data is collected from product vendors as well as the DOTs.

To get an accurate representation across the United States, the researchers successfully contacted thirty-two states. Out of these thirty-two states, only twenty-nine states completed their interview. For the remaining seventeen states, the researchers failed to identify an appropriate survey participant. Of the twenty-nine participating states, eighteen states had no systems in use. The other eleven participating states used a wide range of systems. These systems included blockades before tunnels to laser activated early warning detection systems (EWDS). Information was received during the interviews as well as through e-mail correspondence and faxes after the initial interview.

After completing the survey portion of the study, the research team conducted site visits to two different states, California and Pennsylvania. The site visits included on-site interviews with individuals involved in the day-to-day operations of the overheight detection devices. Additionally, the researchers observed installed detection systems. The site visits included active detection systems located near tunnels as well as at weigh stations, but excluded all passive devices. The report tabulates the findings so that the Alaska DOT&PF can develop a strategy for reducing the number of oversized vehicle collisions with bridges.

## CHAPTER 2 – FINDINGS

### 2.1 State-of-the-Art Summary

Many states focus a great deal of their effort into the routing of overweight and oversized vehicles that are properly permitted. Much of recent research regarding reducing bridge strikes from oversize vehicles has focused on developing an automatic procedure for routing these vehicles using a geographic information system (GIS) (Osengueda *et al.*, 1999). This focus does not immediately address the State of Alaska's most pressing problem because the current bridge collisions occur because the vehicles fail to obtain the proper oversize permits or ignore the required route provided by their permit.

Limited literature exists regarding the actual performance of overheight warning systems; therefore, the researchers provide a detailed examination of a single reference. The only relative article by Hanchey and Exley (1990) discusses three basic bridge protection schemes. The first is a rigid passive overhead device, which uses an immovable rigid crossbeam set across the road at bridge clearance. Its purpose is to warn the trucks of their overheight condition when the truck strikes the crossbeam. However, this method could cause damage to the trucks and is dangerous to vehicles traveling behind the trucks.

The second scheme investigated by the Mississippi State Highway Department (MSHD) is a nonrigid passive overhead device. The most common form of this device is a set of chains suspended from a span wire. Hanchey and Exley determine that this system is not an adequate warning apparatus to alert the truck drivers of their overheight status because drivers may not hear the chains contacting their vehicle over the prevailing background noise of the truck engine.

The third scheme investigated is an active detection and warning system. This device utilizes infrared beams, audible bells and warning signs with flashing beacons to warn drivers that his or her truck exceeds the height of an upcoming bridge. The manufacturer of the active detection and warning system states that it is capable of detecting an object between 1 and 100 miles per hour and that rain, fog, and snow should not interfere with operation of the unit. MSHD decided to implement the active detection and warning system. Each approach to a bridge requires a separate system and each system cost an average of \$25,000 to \$30,000 in 1989. The implementation occurred on three selected bridges; one of these was hit once every two weeks before the installation. One year after installment, this same bridge had not been hit once. Hanchey and Exley suggest that the audible alarm bells are not useful given that the truck engines are too loud. Overall, Hanchey and Exley can conclude no real guarantee of this system because bridge strikes cannot be fully eliminated due to human error.

Bowman (1993) considers warning devices for a number of concerns; however, one section specifically examines vertical clearance where the device needs to warn drivers of upcoming low-clearance obstructions and reduce the frequency of bridge strikes. One family of signage focuses on simply providing information, such as vertical clearance

warnings, vertical heights, and arrows indicating low clearance. The second family of devices focuses on reducing bridge strikes. Bowman also identifies a passive nonrigid device, his findings are not as harsh as Hanchey and Exley; however, he concludes that its effectiveness is unclear and costs from \$2,000 to \$35,000 to install. Another sign is for use with infrared or laser sensing device to create the active detection and warning system that Hanchey and Exley describes, absent the audible alarms. Bowman reports the cost of the full system at \$57,000. One particular installation uses a pair of detector loops to verify the presence of a vehicle and prevent a false activation caused by blowing debris or birds. The California Department of Transportation (Caltrans) has some upcoming research projects involving the effectiveness of overheight detection devices. Appendix A provides the contact information for the research coordinator.

## 2.2 Vendor Survey Results

Based on the results and descriptions of the limited previous research, the passive rigid and nonrigid devices do not seem to require extensive expertise in their design nor installation. Most likely, any decision to create a nonrigid device can be undertaken in-house; therefore, this project did not search for passive device vendors. This section focuses on a selection of vendors that provide active laser or infrared overheight detection sensors. The vendor survey is not meant to be comprehensive because all that this study requires is a more thorough description of the active laser or infrared overheight detection sensors, their performance measures and operating concerns. All of the vendors considered in this survey have installed a system in at least one of the respondent states. Table 2.1 presents selected results from this survey.

**Table 2.1. Vendor Survey Results**

<b>Vendors</b>	<b>Material Cost</b>	<b>System Life</b>
International Road Dynamics (IRD)	\$15 - 70K, including labor	10 - 20 years
Trigg Industries International	\$40 - 45K, including labor	10 - 20 years
Sick AG	\$25 - 75K, including labor	10 - 20 years
Elwood	\$500, detector only	10 - 12 years

For these sensors, large variations exist between vendors with respect to the method they use to package their system. Clearly, this causes the material cost to vary because each vendor may provide more or less in accessories in a single package price. IRD typically includes the labor cost to install the unit when considering the material cost because they do their own installation. On average, labor seems to run ten to twelve percent of material costs. When a system is purchased from IRD it contains the overheight sensors, logic modules, wireless communications modules, cabinets and enclosures. IRD also tries to use wireless communication whenever possible to reduce installation costs. Trigg Industries uses the same basic design where one laser crossing the road is read by a logic module. If this laser is broken, the module will send a message to the warning portion of the system and trigger lights and (or) audio system. Trigg Industries does not include labor in their cost, and their price sheet is available in Appendix B. The large variation in

price between the two of the companies occurs because they have multiple systems that they select to specifically meet the needs of the customer. Elwood only has one material cost because they only include the laser and reader in their system. All other wiring must be designed and installed on site. Although systems vary slightly from one vendor to another they all suggest the use of line power rather than the use of solar power for two reasons, to reduce cost and increase the reliability of the system. Also each system will require frequent checkups to insure proper operation and to make sure the lenses of the laser and reader are clean and free of debris. Appendix B provides further vendor product and contact information.

### 2.3 State DOT Survey Results

This section considers both the states that report overheight detections systems and those that do not. While all forty-nine states excluding Alaska did not participate, the response of twenty-nine states is significant. Thirty-eight percent of the respondent states use EWDSs. Table 2.2 provides summary data from the states possessing overheight warning devices. The complete DOT survey results for both those states with and without warning systems can be found in Appendix A.

**Table 2.2. Survey Results for States With EWDS**

State	Manufacturer	EWDS Used	System Affect on Impacts	Initial Cost
Kansas	Elwood	Laser system	Reduction	\$500 + labor
Iowa	In House	Chains	Slight reduction	N/A
New York	In House	Headache bar	Slight reduction	N/A
Oregon	IRD	Laser system	Reduction	\$32,000
Idaho	IRD	Laser system	Reduction	\$65,000
Pennsylvania	IRD	Laser system	Reduction	Unavailable
Florida	In House	Light beam	Reduction	Unavailable
Louisiana	IRD	Laser system	Reduction	Unavailable
Mississippi	Unavailable	2 EWDS	Slight reduction	Unavailable
Maryland	Unavailable	Light beam	Reduction	50,000
California	IRD, Trigg	Laser system	Reduction	10,000-20,000 + Labor

Typically, less sophisticated passive EWDSs can be manufactured by the DOT that intends to use it while the more sophisticated active systems tend to be designed and installed by vendors (see section 2.2). Of the respondent states, only two (Iowa and New York) use passive systems; all of the remaining respondent states with EWDS use an active system involving detection and directive warning signs. Both of the states use these passive devices on only low speed urban roads. The laser and infrared detection systems can be used on high-speed roads. Many of the states use the EWDSs at interchanges to warn overheight vehicles to avoid the upcoming overpass and direct drivers to detour around the potential hazard. Tunnels and bridges represent another common location for implementing EWDS to reduce crashes into these expensive infrastructure components. Other states use EWDS at weigh stations to assist personnel

in the detection of overweight vehicles. Any trucks that are found to be overweight can then be fined and permitted for a safe route or simply warned of low bridges in the area. None of the states have encountered any liability concerns associated with the implementation of an active EWDS; however, some concerns exist with the passive devices because they may generate debris that other motorists strike. The states lack definitive before-after studies that support the effectiveness of their EWDS; however, all of the states believe the systems have a positive effect, which is shown in Figure 2.1.

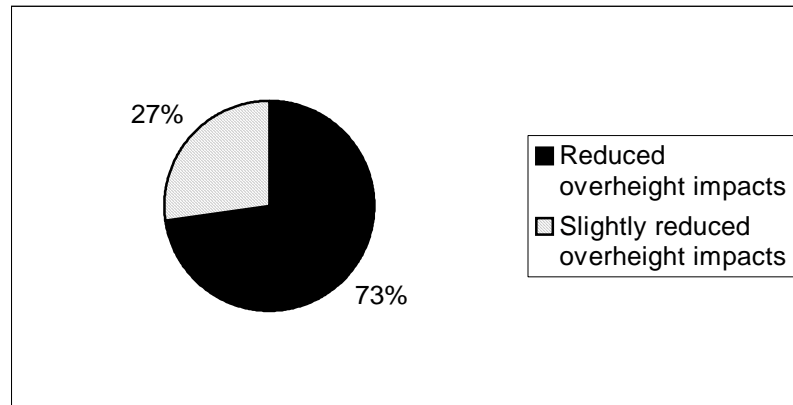

Figure 2.1. Effectiveness of EWDS

Figure 2.1 shows that most states (73%) believe their systems reduce overweight loads striking infrastructure components. One should further note that of the three states that only believe their system slightly reduces impacts two of those use passive systems. These passive systems encounter similar concerns as to those that Hanchey and Exley (1990) describe. The laser and infrared systems appear to successfully reduce bridge impacts, but this does not imply that they operate problem free. For example, the responding DOTs experience false detections from antennas, debris, birds, and snow deposits on the top of trucks. Additionally, some DOTs experience hunters sighting their weapons on receivers, and occasionally the laser moves and comes out of alignment with the detector (see section 2.5). The one state that uses battery power for its system encounters significant problems. The states that use laser and infrared detection systems appear to value the reduction in impacts regardless of the small operational difficulties that they experience.

While the capital cost associated with implementing a laser or infrared EWDS may seem significant, the operating and maintenance (O&M) seem to be quite insignificant. According to the respondent states, the O&M costs for the EWDSs tend to be negligible regardless of the specific system that an individual state uses. The highest reported O&M costs are \$2500 in Oregon, and eighty percent of the respondents did not identify any O&M costs. The initial costs for an active EWDS vary widely because each state can design a system that meets its particular needs. The states identify few maintenance concerns (forty-five percent report no problems at all), but they mention the following issues specifically: the alignment of the laser and detector, the occasional cleaning of lenses, and insuring the power is still being supplied to the system. Maintenance cost

does not seem to be a significant impediment in the selection of EWDS to reduce overheight loads from striking infrastructure.

Sixty-two percent of the respondent states do not seem to use any EWDS to reduce overheight vehicle collisions with infrastructure. Many of these same states use warning lights and signs to reduce collisions. This option represents the least expensive alternative for attempting to reduce the aforementioned crashes. In the absence of a EWDS, these states report minimal, few, some or frequent infrastructure crashes. The percentage of these states reporting each qualitative rate is given by Figure 2.2. Many of these states without EWDS do not seem to have a significant numbers of overheight vehicles striking infrastructure because only a third of them encounter some or frequent strikes annually; the remaining two thirds only encounter few or minimal strikes. Signs and lights seem to be an inexpensive option for minimizing infrastructure crashes when they are not too frequent.

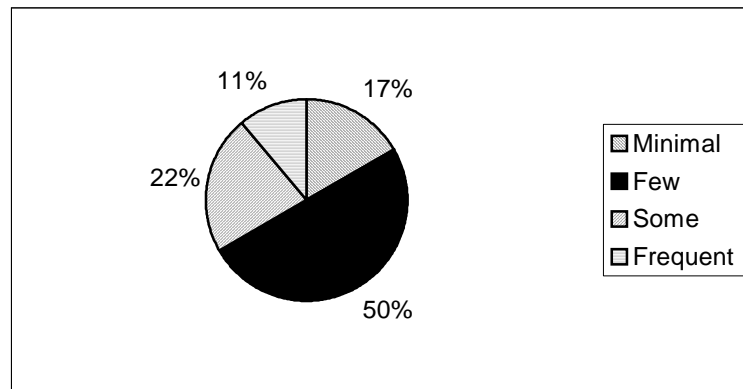

Figure 2.2. Number of Infrastructure Strikes in States Without EWDS

## 2.4 Alaska Railroad

The Alaska Railroad currently uses an incandescent light with a photocell for detecting when their trains experience excessive lateral movement. This product is produced by General Electric (GE) Transportation & Global Signals. The Alaska Railroad only uses this system during the summer because it is affected by snow and gives false readings during the winter. During winter months, the system is replaced by the simple scheme of a string attached to an alarm system. This summer, they are installing a pulse infrared system also produced by GE Transportation & Global Signals, which they hope will function better year-round. The tests to examine the new system's effectiveness will begin this winter. Appendix B features more information about the GE systems.



## 2.5 Site Visits

The researchers conducted site visits to both western Pennsylvania and southern California; both states use laser systems to detect overheight vehicles. The site visits occurred during the summer under dry conditions. The researchers selected the Pennsylvania site because the Pennsylvania DOT (Penn DOT) reported false positives that resulted from snow, and the Penn DOT staff seemed extremely helpful. A large snowfall event at the EWDS sites in Pennsylvania would be about twelve inches. California was selected because it had numerous weigh stations within driving distance of a single location (see Appendix D for the website of the map of the weigh stations). California DOT (Caltrans) Headquarters reported that every weigh station had functional overheight detection systems. For the site visits, the researchers attempted to gather answers to the questionnaire found in Appendix C. These site visits provided the researchers an opportunity to meet with the actual operators of the EWDSs.

### 2.5.1 *Pennsylvania*

Two Pennsylvania EWDSs are located in the Pittsburgh area to reduce overheight loads striking two tunnels on major highways southwest and east of the downtown area. Penn DOT has used overheight detection since the mid 1970s when they first tried bi-directional detection at the same sites as existing systems. Penn DOT has recently (within the past five years) installed the latest incarnation of their EWDS; these sites use laser detection as seen in Figure 2.3. Penn DOT does not report any operating or maintenance problems with either site; however, snow and sometimes rain will cause false positives. At this time, they do not use any mitigation approaches to reduce the false positives. Furthermore, the maintenance and operating costs seem minimal; Penn DOT does not believe they spend more than \$1000 to maintain all eight detectors and the warning signs. At both sites, power supply is not a concern.

As both sites are located in an urban area, both approach freeways have numerous interchanges with exit ramps. Both systems attempt to divert any overheight vehicles off of the freeway at one of these interchanges. The Penn DOT systems typically have the detectors placed at least a quarter mile upstream of the exit ramps. Each installation has different characteristics because one has operations personnel on-site at the tunnel while the other does not. In essence, the site without operations personnel operates as a remote site like most sites in Alaska would likely operate. This report considers this site first.

This first site's configuration is rather straightforward. The detector that Figure 2.4 displays attempts to detect any overheight vehicles. When a vehicle is detected, an active message sign is activated as shown in Figure 2.5. If an overheight vehicle is detected, then a text message adding overheight truck to the sign is illuminated. A standard traffic controller is configured to illuminate the sign only for the proper truck. By using inductance loops imbedded in the pavement, the controller estimates the overheight vehicle's speed and illuminates the sign as this vehicle approaches. The system automatically resets itself after the sign is illuminated for a fixed time period. If an overheight vehicle misses the last interchange, a supplementary warning sign begins to

flash that warns all vehicles to prepare to stop. Penn DOT expects this sign to possibly stop the overweight load before it impacts the tunnel, but it will more likely assist other road users to approach a potential accident at the tunnel mouth more cautiously.



Figure 2.3. Laser Overheight Detector



Figure 2.4. Upstream laser overheight detector on a standard pole



Figure 2.5. Responsive Message Sign Directing Overheight Vehicles to Exit

The second site is much more extensive, and it actually has a series of overheight detection devices to provide enough warning to initiate a red signal on the main lanes of the freeway. A sample screen from this installation can be found in Appendix D; this screen also provides a diagram of the installation. The first set of detectors causes a series of warning signs to begin flashing as figure 2.6 shows. After the first set of detectors, additional detectors are placed downstream of each exit ramp. If these subsequent detectors detect an overheight truck, the system continues its preparation to initiate a full stop of the freeway. If the final exit ramp is missed, the traffic signals in Figure 2.7 show will turn red and stop all traffic. Additionally, the opposing flow is also stopped on the opposite side of the tunnel. After stopping all traffic, the tunnel operators can then assist the overheight vehicle in turning around. This site has a volume of about 120,000 vehicles per day, and trucks account for five to ten percent of the vehicle stream. Even though this system seems extremely effective, Penn DOT still has an overheight vehicle collide with the tunnel about once every two months. The system's success can be observed by the fact that three to four times per week traffic will be stopped by a red signal and a truck will be manually diverted in the opposite direction. After completing the diversion, the tunnel operators can reset the system. Penn DOT recommends setting the detection height above the permitted height, but still below the safe height for the tunnel or bridge. Penn DOT remains very pleased with the effectiveness of the system installed at both locations in the Pittsburgh area, and they claim that the system has definitely reduced overheight load related crashes.



Figure 2.6. Active Warning Sign



Figure 2.7. Traffic Signals for Stopping Freeway Traffic

### 2.5.2 *California*

Caltrans currently uses overheight detection only at its weigh stations, which eliminates any power supply concerns for the system. Each weigh station seems to operate with little oversight and direct input from Caltrans because the California Highway Patrol (CHP) actually operates the weigh stations and enforces violations. Although Caltrans Headquarters believes all of the detection systems function properly, none of the systems at the four stations the research team has visited functioned properly. At one site in Ventura County, the detection system has been completely removed. Generally-speaking, the operators seem fairly unconcerned that their systems are not functioning properly because they believe they can spot overheight trucks fairly effectively by visual inspection. When the systems are functioning, the systems do not appear to have any significant operational problems, and the maintenance problems seem fairly insignificant, such as cleaning spiders from the detectors. The local operators have no knowledge about the overall O&M costs associated with the system. As previously mentioned, Caltrans is considering an expansion of their overheight detection system to include detection on main lanes. At this time, Caltrans relies heavily on their permitting program to reduce overheight loads colliding with bridges, tunnels, etc.

The system at the Castaic weigh station north of Los Angeles on I-5 has been in place for at least sixteen years; Figure 2.8 displays the laser and logic module. If system detects an overheight vehicle, the light on the control panel (Figure 2.9) illuminates and an alarm sounds. The alarm only sounds and the light only illuminates while the trucks actually interrupt the laser beam. After a truck is detected as overheight, the operators will then hand measure the truck to confirm its height. Although the ages of the systems vary throughout California, the basic system is the same at every weigh station. When the system functions properly, the operators believe it has a definite benefit as it detects thirty to forty overheight vehicles per week. The operators at this site have observed false positives from birds; another commonly reported false positive cause. They also report an unusual source of false positives; apparently, between 1430 and 1600 the sunlight may reflect off of a shiny tanker truck, which blinds the system and results in a false reading. These operators seem to appreciate the system more than in other locations.



Figure 2.8. Detector System at Castaic Weigh Station (California)



Figure 2.9. Control Panel at Castaic Weigh Station (California)

On the second day of the site visit in California, the researchers visited two sites, Otay Mesa and San Onofre, in San Diego County. At the Otay Mesa station, the newest of the stations visited, the system appeared to be misaligned. Figure 2.10 showed the Otay Mesa system. As shown in the figure, the laser portion of this system differed from all of the other visited sites; however, it did not function properly, and the operators did not use it. At the San Onofre station, the operators seemed uncertain of the system's functionality. As a result, their lack of reliance on the system appeared evident. The CHP seems capable of detecting most overweight vehicles without technological assistance.



Figure 2.10. Detector System at Otay Mesa Weigh Station (California)

The State of California attempts to minimize the number of overheight vehicle collisions with the highway infrastructure through an aggressive permit and routing program as well as a CHP escort program. While permitting and routing are common to many other states, the escort program seems worthy of further discussion. Ten years ago the CHP started escorting overheight vehicles. In California, those vehicles between the permitted level and sixteen feet fall in a gray area that does not require police escort while those greater than sixteen feet require the escort. When police escort is required, the police officers are completely in charge of the movement of the load; if they decide the load is unsafe to move, or the permit is incorrect, then the load will not be moved. The officers conduct a safety briefing of the driver and pilot vehicle to insure that the entire convoy will proceed safely. Additionally, the convoy contains a pilot car that has a mast arm to the permitted height of the vehicle; therefore, if the mast arm strikes any object, the truck will have an opportunity to stop safely. The police officers that perform truck escort receive overtime pay from the carrier through a reimbursable service agreement. Occasionally, the CHP encounters problems with this program when the police officers fail to measure the load. Regardless, the State of California believes this represents a vital component in the management of overheight truck-infrastructure crashes.

## **CHAPTER 3 - INTERPRETATION, APPRAISAL, AND APPLICATIONS**

### **3.1 Implications of Survey and Analysis**

Whenever a survey is conducted that requires specialized knowledge, locating the proper people to respond to the survey poses a difficulty. For this project, the respondents from each DOT may not have had precise information regarding the operation occurring throughout the state. A more in depth data collection effort may have reduced this problem slightly, but this likely has very minimal impact on the findings of this study. On the other hand, the lack of definitive before-after studies makes assessing the benefits associated with implementing a new system difficult to quantify. Although this study relies on anecdotal data, the findings still merit consideration because they tend to be fairly uniform across all states. Finally, most states lack the definitive O&M costs associated with their EWDS. Once again this lack of information seems undesirable, but its ultimate impact on the project seems minimal because the responses tend to be fairly uniform. While some data is lacking from the analysis, some conclusions can still be drawn based on the observations of the respondent states.

### **3.2 General Recommendations**

Many approaches exist to reduce overheight loads striking infrastructure; however, some approaches seem more successful than others. The lack of independent data makes the selection of a recommended solution difficult but not impossible. From a safety and effectiveness point of view, the laser or infrared system seems most effective, especially when combined with an active sign and warning system. However, this system remains susceptible to human error and collisions still occur within every state that utilizes it. A less expensive and likely less effective approach may be to simply sign the infrastructure more extensively.

The overlying potential for human error creates a situation where a multifaceted approach seems reasonable. A technological or infrastructure based solution may reduce a large percentage of the overheight load crashes; however, a legislative or enforcement solution may serve to increase the deterrent to these collisions beyond the current fine, which an insurance company will frequently pay. While assessing the effectiveness of various legislative and enforcement schemes remain beyond the scope of this study, their inclusion seems essential to the long-term goal of minimizing collisions.



## **CHAPTER 4 - SUGGESTED RESEARCH**

This area has many opportunities for further research. More data is necessary to create an easily utilized guide for selecting overheight detection and warning solutions; however, the creation of such a guide poses the opportunity for its use in future designs and existing facilities to improve safety and reduce maintenance costs. Data remains especially lacking in the area of the actual performance of a given solution because there does not seem to be any before and after studies. A qualitative assessment may not be adequate for all decision-makers and remains difficult to fully defend one alternative over another. The costs associated with increased enforcement and penalties as well as requiring a police escort require careful assessment. These solutions have the opportunity to carry some hidden costs, which must be carefully considered. With this in mind, the operations and maintenance costs associated with each solution require further investigation to determine if they ever have a significant impact, and if so what is it. The continued investigation of this topic has the potential to create a statistically justified approach for reducing the likelihood of overheight load striking infrastructure.

A field-test of one or more of the solutions may assist in increasing future implementation of the tested solutions because any approach still needs to be proven effective for the State of Alaska. Failure to attempt a field test or invest in further statistical analysis will likely reduce the long-term prognosis for successful implementation. A significant education effort may also be necessary within the Alaska DOT&PF because all interested parties and decision-makers need to realize that any solution is unlikely to be perfect and collisions will still likely occur.

## REFERENCES

- Bowman, B.L. (1993). *Supplemental Advance Warning Devices*. National Cooperative Highway Research Program, Synthesis of Highway Practice Report 186. Transportation Research Board, National Research Council, National Academy Press, Washington, D.C.
- Hanchev, C.M. and S.F. Exley, (1990). "Overheight Vehicle Warning Systems in Mississippi," *ITE Journal*, 60 (6), pp. 24-29.
- Osengueda, R., A. Garcia-Diaz, S. Ashur, O. Melchor, S-H. Chang, C. Carrasco and A. Kuyumcu (1999). "GIS-Based Network Routing Procedures for Overweight and Oversized Vehicles," *Journal of Transportation Engineering*, 125 (4), pp. 324-331.

**APPENDIX A – COMPLETE STUDY RESULTS**

**Caltrans’ Overheight Detection Research Project**

Juan Araya (916) 654 – 8170

**Table A.1. Complete Survey Results for States With Systems**

<b>State</b>	<b>Manufacture</b>	<b>Location of system</b>	<b>Detection Used</b>
Kansas	Elwood	Interchanges	Laser system
Iowa	In House	Urban roads	Chains, Signs, Lights
New York	In House	Urban roads	Signs, lights, Headache bar
Oregon	IRD	Bridge systems	Laser system
Idaho	IRD	Main interstate	Laser system
Pennsylvania	IRD	Weigh stations/Tunnels	Laser system
Florida	In House	Bridge systems	Light Beam/Photo Cell
Louisiana	IRD	Interchanges	Laser system
Mississippi	Unavailable	Bridge systems	2 EWDS
Maryland	Unavailable	Tunnel	Light Beam
California	IRD, Trigg industries	Weigh stations	Laser system

**Table A.1. Complete Survey Results for States With Systems (cont’d)**

<b>State</b>	<b>Manufacture</b>	<b>Systems Effectiveness</b>	<b>Liability</b>	<b>Initial Cost</b>
Kansas	Elwood	Reduced impacts	none	\$500 + labor
Iowa	In House	Slightly reduced impacts		N/A
New York	In House	Slightly reduced impacts		N/A
Oregon	IRD	Reduced impacts	none	\$32,000
Idaho	IRD	Reduced impacts	none	\$65,000
Pennsylvania	IRD	Reduced impacts	none	Unavailable
Florida	In House	Reduced impacts	none	Unavailable
Louisiana	IRD	Reduced impacts	none	Unavailable
Mississippi	Unavailable	Slightly reduced impacts	none	Unavailable
Maryland	Unavailable	Reduced impacts	none	50,000
California	IRD, Trigg industries	Reduced impacts	none	10,000-20,000 + Labor

**Table A.1. Complete Survey Results for States With Systems (cont'd)**

<b>State</b>	<b>Manufacture</b>	<b>Maintenance Costs</b>	<b>Speed Limit (mph)</b>	<b>Average Volume of route</b>
Kansas	Elwood	0	20	Unavailable
Iowa	In House	N/A	30	Unavailable
New York	In House	N/A	30	Unavailable
Oregon	IRD	\$2,500	30	3500
Idaho	IRD	Unavailable	65	3100
Pennsylvania	IRD	0	35	Unavailable
Florida	In House	Unavailable	Unavailable	Unavailable
Louisiana	IRD	0	70	Unavailable
Mississippi	Unavailable	Unavailable	Unavailable	Unavailable
Maryland	Unavailable	Basically none	50	Unavailable
California	IRD, Trigg industries	N/A	70	Unavailable

**Table A.1. Complete Survey Results for States With Systems (cont'd)**

<b>State</b>	<b>Manufacture</b>	<b>Truck Percentage</b>	<b>Problems</b>
Kansas	Elwood	Unavailable	None identified
Iowa	In House	Unavailable	Noisy truck can't hear chains
New York	In House	Unavailable	Danger to loads being knocked off
Oregon	IRD	7.70%	None identified
Idaho	IRD	100%	None identified
Pennsylvania	IRD	Unavailable	Set off by snow built up on top of trucks
Florida	In House	Unavailable	Battery operated/batteries would get weak
Louisiana	IRD	Unavailable	Antennas set them off
Mississippi	Unavailable	Unavailable	None identified
Maryland	Unavailable	Unavailable	None identified
California	IRD, Trigg industries	Unavailable	Debris or birds passing through laser

**Table A.2. Complete Survey Results for States Without Systems**

<b>State</b>	<b>Detection Used</b>	<b># of hits on bridges</b>
Alabama	One barrier system	Frequent
Arkansas	Signs and lights	Few
Colorado	Signs	Few
Delaware	Signs and lights	Minimal
Illinois	Signs and lights	Some
Indiana	Signs and lights	Some
Maine	Signs and lights	Few
Michigan	Signs and lights	Few
Minnesota	Signs and lights	Few
Nevada	Signs and lights	Minimal
New Hampshire	Signs and lights	Some
New Jersey	Signs and lights	Minimal
New Mexico	Signs and lights	Few
North Carolina	Signs and lights	Frequent
Ohio	Signs and lights	Some
Oklahoma	Signs and lights	Few
South Carolina	Signs and lights	Few
South Dakota	Signs and lights	Few

## **APPENDIX B – VENDOR PRODUCT AND CONTACT INFORMATION**

### **International Road Dynamics Inc.**

Brian

Phone (306) 653-6611

Phone (306) 653-6600/ Fax (306) 242-5599 / Email info@irdinc.com

[http://www.irdinc.com/english/pdf/sys/OHDetector\\_0111.pdf](http://www.irdinc.com/english/pdf/sys/OHDetector_0111.pdf)



**We make  
highways  
talk™**

- **MANAGEMENT**
- **SAFETY**
- **PRESERVATION**

*International Road Dynamics Inc. develops and maintains traffic management products and systems technology that make highways talk. What are they saying? They are providing information that roadway administrators need to manage traffic, preserve infrastructure and provide safety warnings to drivers.*

*IRD's multi-discipline, innovative and customer-focused team is expert in advanced technologies, advanced traffic solutions and custom-designed systems.*



**CUSTOMER  
DRIVEN**

NOVEMBER 2001, REV A  
PRINTED IN CANADA

**INTERNATIONAL ROAD DYNAMICS INC.**  
www.irdinc.com

## **Overheight Vehicle Detection System (OHVDS)**

**Are your overhead structures being damaged by overheight vehicle collisions? We can help you!**

### **OVERVIEW**

IRD is an integrator and supplier of an Overheight Vehicle Detection System (OHVDS) that reduces collisions between motorists and overhead structures. An Overheight Vehicle Detection System detects overheight vehicles moving toward overhead obstacles, such as bridges, tunnels and other structures, and individually warns drivers. The system provides the driver with the opportunity to actively avoid a collision with an overhead structure.

The OHVDS is comprised of a transmitter and receiver. The transmitter contains either an infrared or high intensity, visible red light source that is pulsed across the highway from the transmitter to the receiver. The receiver is designed to issue an alarm if the red beam is blocked by an object at least 5 cm (2") in diameter, 2.5 cm (1") above the line of detection and moving between 1 km/h (1 MPH) and 120 km/h (75 MPH). The transmitter and receiver may be direction discerning, which triggers the alarm only when vehicles traveling in a certain direction are considered overheight.

The alarm activates a warning sign with alternating flashers and/or an audible alarm. In the event of a failure, the system will not activate the flashers on the sign, but will display a constant message, such as "WARNING - HEIGHT RESTRICTION".

This system reduces damage to structures by overheight vehicles. The driver is made aware of the danger ahead and is provided with the opportunity to take alternate action or an alternate route.



### **APPLICATIONS**

To provide overheight warning detection for:

- Overpasses
- Traffic tunnels
- Bridges
- Warehouse entrances

### **BENEFITS**

<b>Driver:</b>	Reduces damage to trucks/trailers and occupant injuries
<b>Government/Owner:</b>	Decreases damage to public structures
<b>Public:</b>	Decreases traffic backups due to a reduction of vehicle collisions with overhead structures
<b>Insurance Companies:</b>	Reduces accident claims due to a reduction of truck - overhead structure accidents

*IRD products and components are protected by one or more U.S. and Canadian patents. IRD reserves the right to change, modify, or improve its products at any time without notice.*

# Overheight Vehicle Detection System

## SENSOR TECHNOLOGY AVAILABLE

- Infrared Light
- Visible Red Light

## OPTIONAL SIGNS

As an alternative to flashing warning signs, changeable message signs (CMS) or variable message signs (VMS) may be incorporated into the system. Changeable message signs have two (2) or three (3) predetermined messages that become visible when activated. Variable message signs are fully variable and when activated will display a predetermined message (e.g. "WARNING - HEIGHT RESTRICTION"). During times when the message sign is not activated, the sign may display any operator-defined message or image.



## OPTIONAL VIDEO

As an option, a video component can be added to the system to capture and store video images of vehicles which trigger the overheight detector.

## SPECIFICATIONS

Power	115 VAC +/- 10%, 50/60 Hz Other options include 24 VDC solar power on 230 VAC on special order for certain models of transmitter and receiver
Output	Form C, dry relay contact closure Contacts rated 115 VAC 10A, protected by an 8A circuit breaker
Climatic Operating Range Environmental Control	-40 to + 58°C (-40 to +135°F) Internal thermostat controls air flow which reduces moisture and maintains internal temperatures during cold weather (on some models)
Alarm Time Maximum Range*	Adjustable between 2 and 30 seconds Suggested maximum range 60 meters (200 feet) to allow for bad weather and lens contamination. Absolute maximum range of 215 meters (700 feet)
Reaction Speed	1 to 120 km/h (1 to 75 MPH) for a 5 cm (2") diameter object 2.5 cm (1") above the established height of detection
Housing	External housing is heavy ALMAG casting and sheet aluminum (not less than 1/3 cm (1/8") thickness) to minimize vandalism and provide for rigid mounting
Shipping Weight	14 to 23 kg (30 to 50 lbs)

\* Maximum range refers to maximum distance the detector eyes will perform



International  
Road Dynamics Inc.



### Corporate Offices

702-43rd Street East  
Saskatoon, Saskatchewan  
Canada S7K 3T9  
Tel: (306) 653-6600  
Fax: (306) 242-5599

#305-1006 West 104th Ave.  
Northglenn, Colorado  
USA 80234  
Tel: (303) 355-5998  
Fax: (303) 426-8937

Publicly Traded on the TSE (Symbol IRD)  
Find out more about IRD on our website: [www.irdinc.com](http://www.irdinc.com)

IRD products and components are protected by one or more U.S. and Canadian patents.  
IRD reserves the right to change, modify, or improve its products at any time without notice.

PRINTED IN CANADA



**Sick AG**

Phone (49) 76 812 02-0 / Fax (49) 76 812 02-3863 / Email <http://www.sick.de/de/en>

<http://www.sick.de/de/products/categories/process/tunnelsensors/hisic450/en.html>



Figure B.1. SICK HISIC450 Overheight Vehicle Detector



## Trailblazing Traffic Measurement Systems

**SICK**

# On the move with leading traffic technology.

When the going gets tough, the tough get going.

The main challenge facing future traffic systems is: More safety – less congestion. Intelligent traffic measurement systems will be a pre-requisite for the modern transport networks of the future. We have got going to find solutions for some of these requirements by developing high-technology measurement systems.

- Visibility/CO concentration systems in tunnels
- Air velocity monitors for tunnels
- Road visibility measurement devices
- Overheight detectors

## Tested and certified.

SICK was one of the first producers of measurement systems to meet the requirements for DIN-norm ISO 9001 in all its corporate sectors. The certificate is granted for excellent performance in product development, production, quality control, staff training, environmental protection and customer service.

## In tunnels: In-situ systems

Continuous measurement of the concentrations of pollutants is essential in view of ever increasing traffic densities. SICK's in-situ measurement devices determine exhaust gas concentrations where they are produced. This not only makes effective monitoring and control of tunnel ventilators possible, but also guarantees economical operation of ventilation systems.

Technical data
Measurement principle
Measurement path
Measured Quantity
Measuring range
Resolution
Enclosure rating

## Visibility and CO Measurement for road tunnels



### VICOTEC 410 series

The VICOTEC 410 series of compact analysers provide measurement values for determination of visibility or carbon monoxide concentrations in road tunnels.

- VICOTEC 411 for measuring visibility
- VICOTEC 412 for determining CO concentrations
- VICOTEC 414 for the simultaneous measurement of visibility and CO concentrations.

These intelligent measurement devices request maintenance when sensors are polluted – reducing maintenance costs to a minimum.

The VICOTEC 411 permanently monitors visibility in a tunnel and thus provides continuous information on light conditions. A continuous, real-time control signal provides optimum ventilator efficiency.

The VICOTEC 412 monitors CO pollution within the tunnel atmosphere itself.

The VICOTEC 414 offers combined measurements for simultaneous monitoring of both visibility and CO concentrations.

VICOTEC 411	VICOTEC 412	VICOTEC 414
Transmission	Negative gas correla-	Trans./neg. gas corr.
10 m		
Visibility, K factor	CO concentrations	Visibility, CO
K = 0-10 · 10 <sup>-3</sup> m <sup>-1</sup> , K = 0-15 · 10 <sup>-3</sup> m <sup>-1</sup>	0-300 ppm	K = 0-10...15 · 10 <sup>-3</sup> m <sup>-1</sup> CO = 0-300 ppm
IP 65		

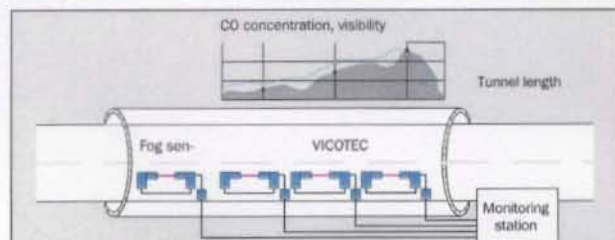



### FLAWSIC 200

The FLOWSIC 200 is used for the accurate measurement of wind speed and direction inside tunnels or exhaust ventilation ducts, in which it determines a cross-sectional mean value. This measurement device is indispensable when air flow is dictated by climatic conditions – for ensuring optimal ventilation control and reducing running costs to a minimum.



### VISIC 610

The VISIC 610 measures the standard range of visibilities and can clearly distinguish between visibility impairment caused by rain and fog. Its unique and extensive self-test functions and comprehensive pollution compensation (not usually found in scattered light measurement devices) enable this device to operate continuously in harsh conditions in traffic control systems.

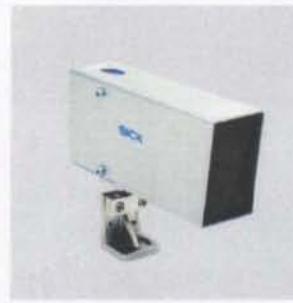

### HISIC 450

The HISIC 450 overhead detector reliably detects vehicles which are too high – at tunnel entrances, low underpasses or bridges, for example. Stop and alarm signals are immediately activated when a vehicle infringes the photoelectric switch. Even overheight vehicles travelling at speeds of up to 100 kph are reliably detected.

SICK's measurement systems – developed using our sophisticated know-how – are precisely tailored to the requirements of the user and are remarkable for their:

- Accurate measurements, thanks to high-quality optical systems
- Flexibility, achieved by using modular systems
- Self-monitoring and automatic maintenance messaging
- Low maintenance and operating costs.

SICK's opto-electronic measurement systems provide reliable data for traffic control computers and central monitoring stations – working to promote active traffic safety.

#### FLAWSIC 200

Ultrasonic time-of-light difference

14 m (tunnel width)

Air velocity and direction

0 – 20 m/s

IP 65

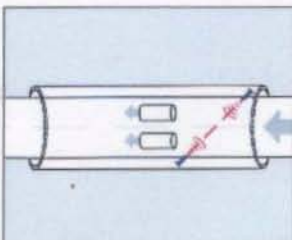

#### VISIC 610

Scattered light measurement

Approx. 500 mm

Visibility and precipitation

Standard 10–500 m

10 m

IP 55 during operation

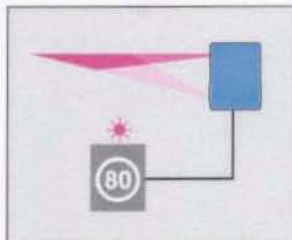

#### HISIC 450

Duplex photoelectric switch

100 m

Overheight yes/no

IP 65

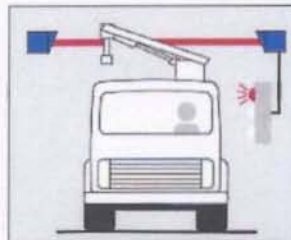

## Interested? Copy, Fill In and Fax Back.

Company	
Name	
Position/ Department	
Address	
Post code/ Town	
Phone/Fax	
Industry/Field of application	

I would like to know more about SICK's Environmental Monitoring.

I am interested in a detailed consultation with one of your project consultants. Please arrange an appointment for me.

**Your contact:**

**Argentina**  
Phone +54 11 45550055  
Fax +54 11 45550444

**Australia**  
Phone +61 3 94 97 41 00  
(008) 33 48 02 - toll free  
Fax +61 3 94 97 11 87

**Austria**  
Phone +43 22 36 62 28 8-0  
Fax +43 22 36 62 28 85

**Belgium/Luxembourg**  
Phone +32 92 24 03 94  
Fax +32 92 23 56 45

**Brazil**  
Phone +55 11 50 31 38 81  
Fax +55 11 50 31 16 22

**Canada**  
Phone +1 (905) 771-1444  
oder 771-14 15  
Fax +1 (905) 771-16 16

**Chile**  
Phone +56 2-274 74 30  
Fax +56 2-0493 38

**China/Hong Kong**  
Phone +86 21 64 85 47 67  
Fax +86 21 64 85 09 38  
Phone +852 24 25 37 35  
Fax +852 24 25 30 11

**Croatia/Slovenia**  
Phone +38 51-313 50 6  
+38 51-313 50 7  
Fax +38 51-313 50 8

**Czech Republic**  
Phone +42 02 57 91 18 50  
+42 02 57 81 05 61  
Fax +42 02 57 81 05 59

**Denmark**  
Phone +45 439 08 61 1  
Fax +45 436 91 34 0

**Egypt**  
Phone +20 23 61 27 47  
Fax +20 23 60 82 58

**Finland**  
Phone +35 8 97 55 66 11  
Fax +35 8 97 55 32 97

**France**  
Phone +33 1 64 62 35 00  
Fax +33 1 64 62 35 77

**Germany**  
Phone +49 76 41 469-0  
Fax +49 76 41 469-11 49  
The newly-formed  
German States  
Phone +49 3 52 05 52 41 0  
Fax +49 3 52 05 52 45 0

**Great Britain/Ireland**  
Phone +44 17 27 83 11 21  
Fax +44 17 27 85 67 67

**Greece**  
Phone +30 16 74 74 64  
Fax +30 16 74 11 59

**Hungary**  
Phone +36 1-380 60 20  
Fax +36 1-230 86 98

**India**  
Phone +91 2 24 93 84 03  
Fax +91 2 24 93 01 91

**Israel**  
Phone +9 72 9-741 26 57  
Fax +9 72 9-744 24 19

**Italy**  
Phone +39 01 12 23 66 01  
Fax +39 01 12 23 66 09

**Japan**  
Phone +81 3 54 44-09 29  
Fax +81 3 54 44-09 38

**Korea**  
Phone +82 2 34 44 87 81  
Fax +82 2 34 44 79 45

**Lebanon**  
Phone +961/188 50 61  
+961/189 07 10  
Fax +961/188 50 61  
+961/189 07 10

**Macedonia**  
Phone +38 991 13 34 43  
Fax +38 991 13 33 02

**Mexico**  
Phone +52 55 63 81 88  
Fax +52 56 11 00 03

**Netherlands**  
Phone +31 73 599 50 44  
Fax +31 73 599 47 18

**New Zealand**  
Phone +64 9 415 04 59  
Fax +64 9 415 04 65

**Norway**  
Phone +47 6 38 7 02 00  
Fax +47 6 38 7 02 01

**Pakistan**  
Phone +92 2 56 59 85  
Fax +92 2 14 97 14 65

**Poland**  
Phone +48 2 26 44 83 45  
Fax +48 2 26 44 83 42

**Portugal**  
Phone +35 1 234 303 900  
Fax +35 1 234 303 910

**Romania**  
Phone +40 1 687 34 62  
Fax +40 1 242 68 24

**Russian Federation**  
Phone +7 095 275 22 73  
+7 095 275 29 33  
+7 095 275 75 63  
Fax +7 095 279 67 76

**Singapore/  
Malaysia/Thailand/  
Indonesia/Philippines**  
Phone +65 744 37 32  
Fax +65 841 77 47

**Slovak Republic**  
Phone +42 17 54 43 40 89  
Fax +42 17 54 41 49 64

**South Africa**  
Phone +27 11 455 38 09/38 16  
Fax +27 11 455 46 88

**Spain**  
Phone +34 93 480 31 00  
+34 91 642 61 12  
Fax +34 93 473 44 69  
+34 92 642 61 12

**Sweden**  
Phone +46 8 632 30 00  
Fax +46 8 632 32 99

**Switzerland**  
Phone +41 41 612 17 00  
Fax +41 41 612 17 01

**Taiwan**  
Phone +88 62-8797-1981-6  
Fax +88 62-2799-0272

**United Arab Emirates**  
Phone +97 14-324 75 00  
Fax +97 14-324 25 00

**USA**  
Phone +1 (612) 941 67 80  
Fax +1 (612) 941 92 87

# HISIC-FR

## Overheight Vehicle Detection System

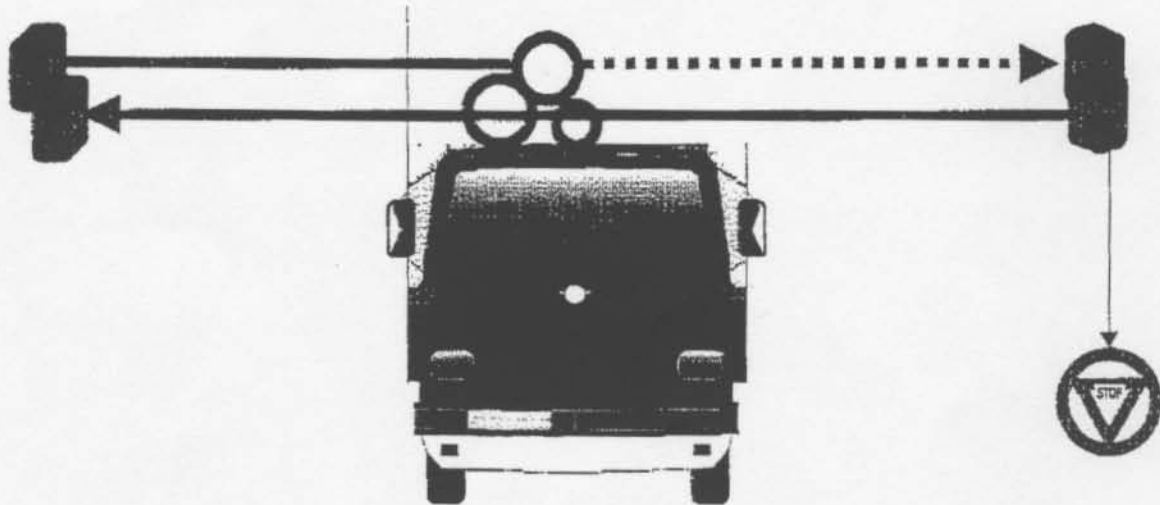

English/French

# SICK

## CONTENT

<b>1. PRODUCT DESCRIPTION</b>	3
<b>2. PRINCIPLE OF OPERATION</b>	3
2.1. PRINCIPLE	3
2.2. OPERATION	4
2.3. RESET OF ALARM OUTPUT	5
2.4. DIRECTION DETECTION	5
<b>3. VERSIONS</b>	5
ORDER NUMBER	5
<b>4. COMMISSIONING</b>	6
4.1. ELECTRICAL INSTALLATION	6
4.2. HISIC SETTING	6
4.2.1. SETTING THE WSWE45	6
4.2.2. SETTING THE HISIC-FR	7
<b>5. TECHNICAL DATA</b>	8
5.1. ELECTRICAL	8
5.2. MECHANICAL	8
<b>1. GÉNÉRALITÉS</b>	10
<b>2. PRINCIPE DE FONCTIONNEMENT</b>	10
2.1. PRINCIPE	10
2.2. FONCTIONNEMENT	11
2.3. RESET DE LA SORTIE ALARME	12
2.4. SENS DE DETECTION	12
<b>3. VERSIONS</b>	12
N° DE COMMANDE	12
<b>4. MISE EN SERVICE</b>	13
4.1. CÂBLAGE EXTERIEUR	13
4.2. REGLAGES	13
4.2.1. Réglages des cellules WSWE45	14
4.2.2. Réglages du HISIC-FR	14
<b>5. CARATÉRISTIQUES ELECTRIQUES / MÉCANIQUES</b>	15
5.1. CARACTÉRISTIQUES	15
5.2. ENCOMBREMENT	15

## 1. Product description

The « HISIC-FR » system has been developed for use before tunnels, bridges, and underground car parks to detect overheight vehicles and loads and to transmit a signal to a control room or variable message sign.

## 2. Principle of operation

### 2.1.Principle

Two optical switches (emitter/receiver) are installed on opposite sides of the road. The distance between the 2 light beams is « D1 ». The photocells are placed at the same height as the maximum authorised value.

#### Plan view:

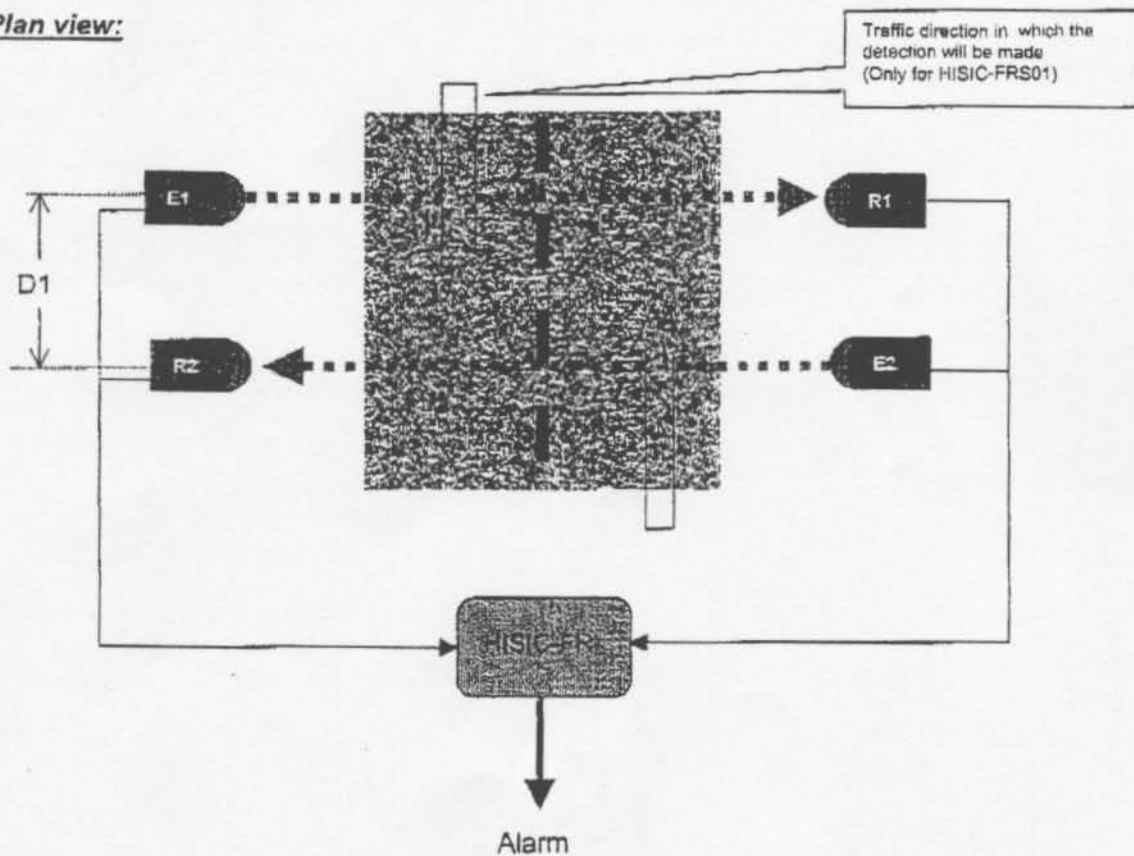

- (E1,R1) and (E2,R2) : light beam switches type WS/WE45
- HISIC-FR : power supply and sensor control unit



## 2.2. Operation

The two sensors are mounted at a distance « D1 » (about 1 m) from each other. An "alarm" occurs when the HISiC-FR control unit simultaneously receives an out-of-range signal from each receiver (R1 and R2); so preventing false alarms (e.g. bird, dead-leaf...)

« Overheight » alarms can occur in two circumstances:

- Protruding object is at least of length « D1 »
- Protruding object is shorter than « D1 » to generate an alarm, the switching signal, given by the clearing of E1R1, must be delayed by the timer incorporated in the receiver R1 (re-set time adjustable between 15 and 300 ms). The value of the delay will be calculated from the minimum speed and the distance "« D1 »"

Example: for a minimum speed of 50 km/h and a distance  $D1 = 1$  m, the value of the delay has to be:  $T = 1 / (50000 / 3600) = 72$  ms.

### Timing:

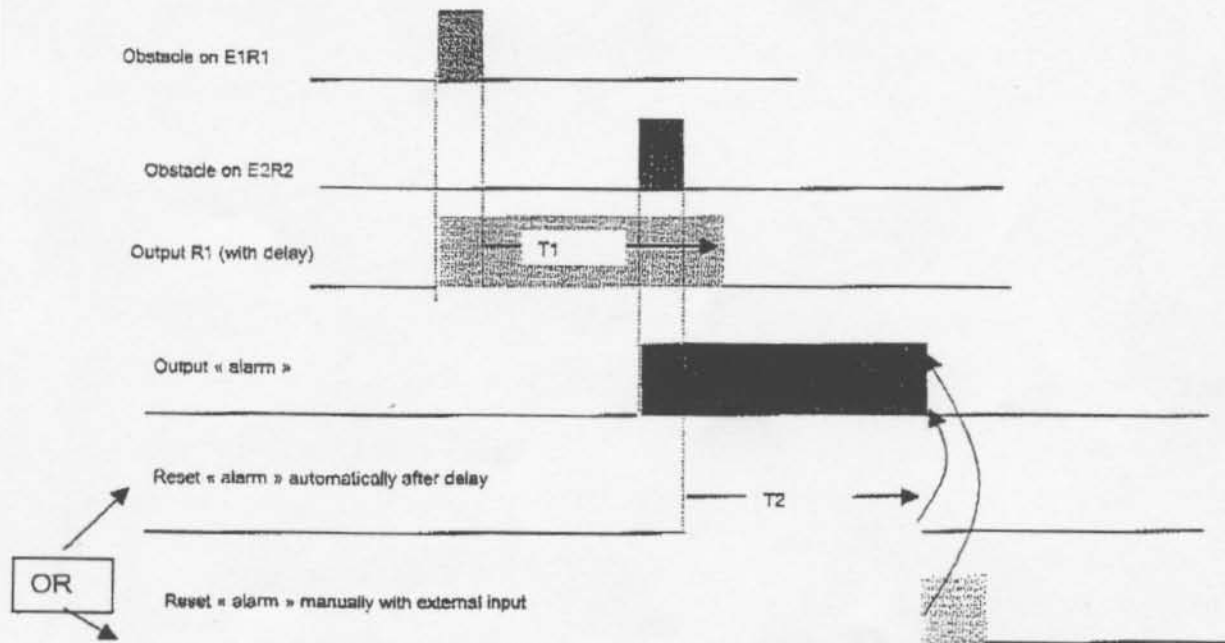

The logical function of the HISiC-FR is an « AND » between R1 and R2. As soon as this function is executed, the «alarm» output is activated.

### 2.3. Reset of alarm output

The alarm output can be reset to 0:

- Either automatically after a time delay, starting with the break of beams E2R2 ; this delay can be adjusted in the EN2 module of HISIC.
- or by closing of an external contact « RESET »

### 2.4. Direction detection

Overheight detection can be made for traffic flowing in one or in both directions. Please see chapter 3 for different versions of HISIC-FR.

## 3. Versions

Two versions of HISIC are available; the differences are indicated below:

	HISIC-FR	HISIC-FRS01
<b>Order Number</b>	7001697	7001752
<b>Direction of traffic</b>	2 ways	One way (E1R1⇒E2R2)
<b>Automatic reset</b>	Delay : 1 to 120 s	Delay : 0 to 1s
<b>Manual reset</b>	Yes	No

## 4. Commissioning

### 4.1. Electrical installation

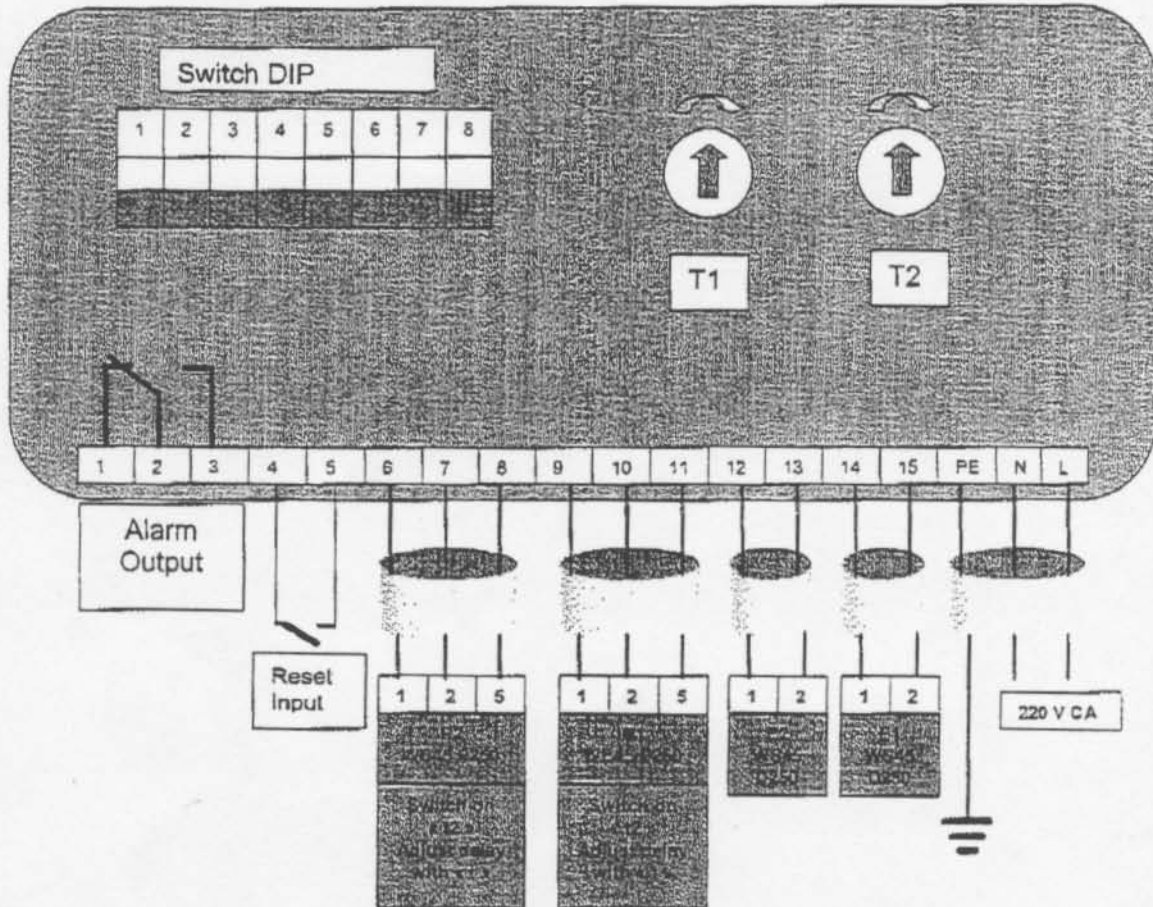

#### NOTE:

1. « Reset » input available only on HISIC-FR
2. In the "one way detection" version (HISI-FRS01), set the delay switch on R2 to « t0 »

### 4.2. HISIC Setting

#### 4.2.1. Setting the WSWE45

- Mechanical setting :

To align the photoelectric sensors, view the receiver (WE45) through the alignment sight at the top of the emitter unit (WS45) and adjust the emitter so that the receiver appears in the middle of the sight. Repeat in the same way with the receiver.

- Adjust the sensitivity :

Set the sensitivity potentiometer to the maximum on each WE45

- Setting the delays :

Set the delay-switch to position "t2" and adjust the delay with the potentiometer(s) on the receiver(s).

NOTE: on the HISIC-FRS01, set the delay-switch of R2 to position "t0"

#### 4.2.2. Setting the HISIC-FR

- Power supply: the power supply EN3 is pre-wired to 220 Vac. To operate with 110 Vac, modify the connection on the EN3 module only.
- RESET of the « alarm » output: the settings are made on the EN2T module with the DIP-switches and the potentiometers T1 (0 to 1s) and T2 (1 to 120s)

➤ **HISIC-FR** : two possibilities :

- Automatic reset after an adjustable delay by T2 (set the T1-delay to minimum).

Position of the DIP-switches



- reset by an external input: set the 2 potentiometers T1 and T2 to the minimum .

Position of the DIP-switches

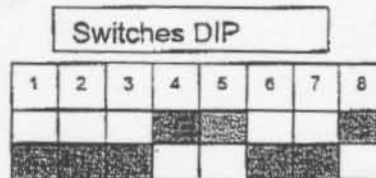

The « alarm » output will be reset by closing the contact « RESET »

➤ **HISIC-FRS01** : the «alarm» output will be re-set after a delay of T1

. Position of the DIP-switches

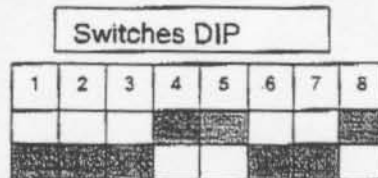

Power supply	220Vac or 110 Vac
Power consumption	
Load voltage/current	250V / 2A
Protection class	IP 67
Dimensions	260x160x90 mm
Cable entries	PG 13,5
Weight	4 kg
Material	Aluminium
Photocells	WS/WE45-P250
Response time	0,5 ms
Max. distance	300 m
Operating temperature	-25°C +55°C

### 5.2. Mechanical

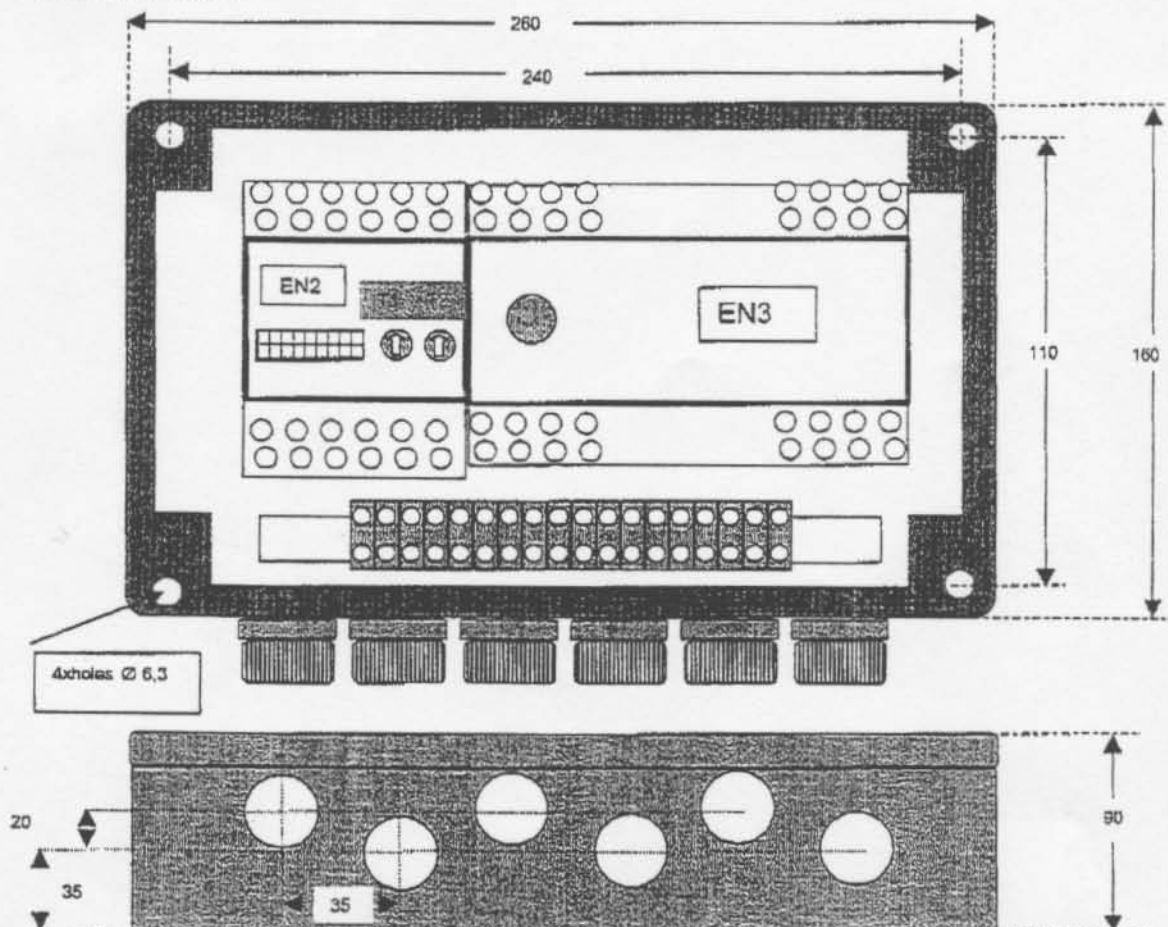

**Trigg Industries International**

Bob Price

(757) 851-3744

Phone (323) 845-9390/ Fax (323) 845-9503 / Email [info@triggind.com](mailto:info@triggind.com)

<http://www.triggind.com/ovds.htm>

# Overheight Vehicle Detection and Warning Systems

## 2002 Catalog

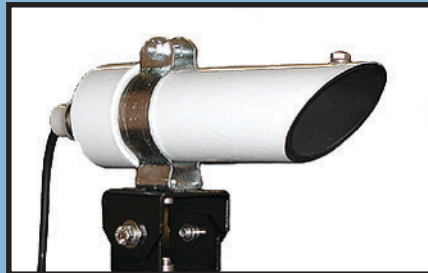

Trigg Industries manufactures complete systems, including detectors, warning signs, alarms, mounting poles and all needed accessories. We offer technical options to meet virtually any overheight warning requirement.



# Contents

OVERVIEW ..... 1

DESCRIPTIONS & CONCEPT ..... 2

TYPICAL INSTALLATIONS ..... 3

PARKING STRUCTURE / TOLL BOOTH INSTALLATIONS ..... 4

OVDS MODEL MATRIX ..... 5

OVDS SPECIFICATIONS

**Double Eye Z-Pattern**

        3400-Z ..... 6

        3401-Z & 3402-Z ..... 7

        3403-Z ..... 8

        Double Eye Z-Pattern Design Notes and Installation Notes ..... 9

        Figure 1: Z-Pattern Concept ..... 9

        Figure 2: Cross Section of Road ..... 10

        Figure 3: View Across Roadway ..... 10

**Double Eye**

        DE-R/3110 & DE-R/3110-S and DE-IR/3111 & DE-IR/3111-S ..... 11

**Single Eye**

        SE-R/3310 & SE-R/3310-S and SE-IR/3311 & SE-IR/3311-S ..... 12

**Metro Economy**

        ME-R/301 & ME-R/301-S and ME-R/305 & ME-R/305-S ..... 13

        ME-R/310 & ME-R/310-S ..... 14

WARNING SIGN MODEL MATRIX ..... 15

WARNING SIGN SPECIFICATIONS

**Blank Out Signs with Alternating Flashers**

        3500 & 3501 ..... 16

        3502-H & 3502-V and 3503-H & 3503-V ..... 17

**VMS Sign with or without Flashers**

        3551-H & 3551-V: One-Line LED ..... 18

        3552-H & 3552-V: Two-Line LED ..... 19

        3505-H & 3505-V: Two-Line LED ..... 20

        3510-H: Three-line LED ..... 21

        3515-H and 3520-H: Four-line LED ..... 22



# Contents

<b>Direction Oriented Alarm Bell</b>	
3600 .....	23
<b>Mounting Poles</b>	
3701 and 3702 .....	24
<b>Three-Axis Mount</b>	
TGZ-M017 .....	25
<b>Pole Mount Bracket</b>	
PMB-406 .....	25
<b>Loop Detector Interface</b>	
TGL-2001 .....	26
<b>Radio Frequency Link</b>	
RFL-1001 .....	27
<b>Solar Power Source</b>	
SELS-2XX .....	28
SITE SELECTION CONSIDERATIONS .....	29
WORKSHEET OF SUGGESTED SPECIFICATIONS .....	30
Preface .....	31
Preparation of Specifications .....	32
Specifications .....	33
Overheight Warning System Cable Wiring Diagram .....	37
CONTACTS .....	38

ovdscat060502jy.p65

# Overheight Vehicle Detection and Warning Systems [OVDS]



## What Does Trigg Industries OVDS Do?

- Detects overheight vehicles and warns drivers of an impending problem.
- Directs the driver via warning signs and warning bells to take corrective action.
- Provides secondary warning beyond existing signage in the interest of public safety.
- Reduces exposure to costs associated with incidents or accidents.
- Proven to minimize or eliminate the occurrence of accidents and incidents caused by overheight vehicles.

## Industry Standard

- The standard for quality and performance in all environments for thirty-five years.
- Integral to hundreds of state, county and municipal infrastructures coast to coast.
- System of choice for Boston Central Artery Tunnel Project, Cumberland Gap Tunnels, Queens Tunnel and 25 DOT's.
- We provide technical support and documentation from the planning stage through installation.

## Applications

- |              |                              |                   |                  |
|--------------|------------------------------|-------------------|------------------|
| • Bridges    | • Airport Overhangs/Walkways | • Equipment Yards | • Logging Trucks |
| • Tunnels    | • Temporary Falsework        | • Railroads       |                  |
| • Overpasses | • Parking Structures         | • Car Carriers    |                  |

## Cost Benefit

One accident usually exceeds the cost of a complete detection and warning system. Trigg Industries OVDS adds an additional layer of protection and helps to minimize or eliminate costs associated with:

- |                          |                        |                         |
|--------------------------|------------------------|-------------------------|
| • Injury or loss of life | • Administrative costs | • Dispute or Litigation |
| • Emergency Response     | • Structural Repair    | • Media Publicity       |
| • Traffic Delays         | • Insurance Premiums   |                         |

## Highest Reliability and Quality Control Standards

Installed in some of the most adverse conditions worldwide. Proprietary cabinet design and internal environmental control allows continuous operation in fog, ice, snow, dust and heat. Systems meet ISO/IEC Guide 22 Compliance, CE Mark, NEMA 3R Cabinet Enclosure Rating, CALTRANS lightning and hi/lo voltage parameters. We provide extensive documentation and Factory Acceptance Testing protocols.

## Innovation

The Trigg Industries Patented Z-Pattern™ Red/Infrared dual beam array provides the most advanced ability to reject ambient light and virtually eliminates false overheight alarms. Fault Detection and Alert Function notifies Central Control Facility when system is operating in Single Eye Mode [temporary condition] or has experienced a line power failure. Double and Single Eye systems also offer Fault Detection and Alert Function.

## Ease of Use

Trigg Industries provides specialized mounting brackets for all systems and all elements of the system that allow it to be attached to any sturdy structure. Installation instructions are direct and easy to follow.

## Descriptions

Device	Description
<b>OVDS</b>	Point of detection and direction discernment. Four categories of systems, encompassing ten different models for a wide range of applications.
<b>Audible Alarm</b>	Sweep of sight is attracted by alarm. First alarm after detection and second above message sign.
<b>Warning Signs</b>	Standard Warning Sign with alternating flashers includes custom message providing directions to drivers of overweight vehicles.
<b>Extras</b>	Variable LED Message Signs (VMS) available in two, three and four line formats. PC programmable.
	Poles, sirens, bells, strobes, solar power, loop detector, radio frequency link and alternate mounts available.

## Concept

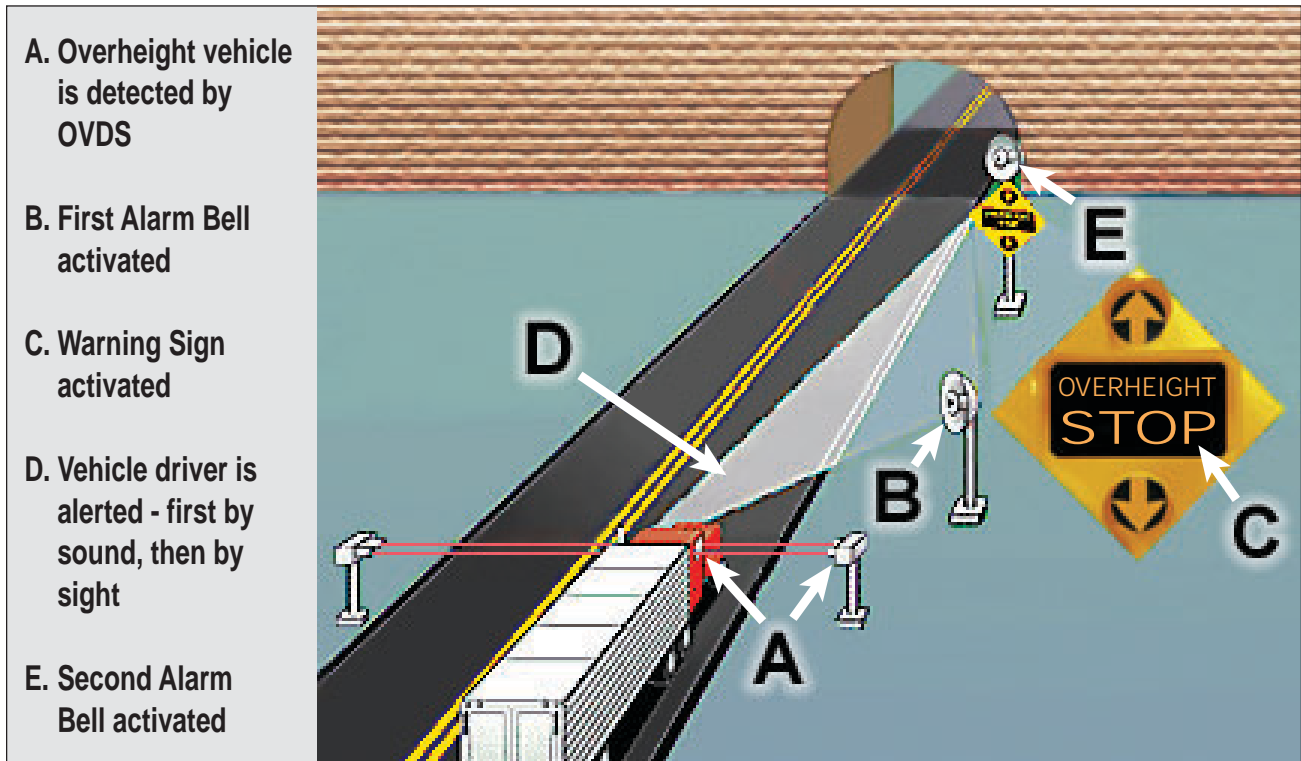

### Typical Installations

- Bridges
- Tunnels
- Overpasses
- Temporary Falsework
- Railroad Tunnels
- Airport pasenger dropoff overhangs and pedestrian walkways

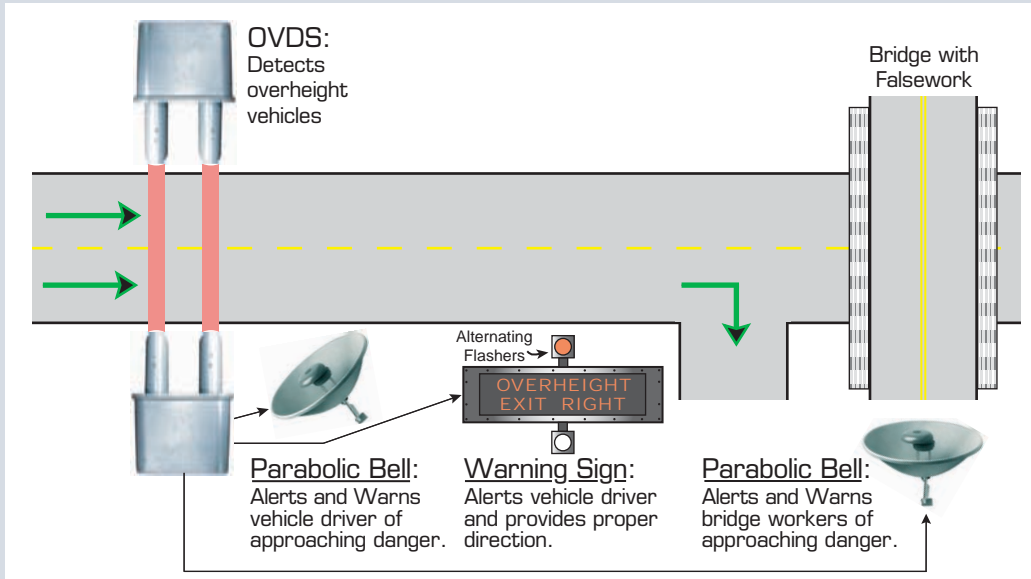

- Weigh Stations
- Load Height Verification for:
  - Equipment Yards
  - Car Carriers



## Parking Structure / Toll Booth Installations

Metro Economy OVDS installed inside parking structure detecting a single height.

Dual Single Eye OVDS installed outside parking structure detecting two different heights.

**EXAMPLE:**

- If vehicle is detected by OVDS #1, driver is instructed by VMS to park where clearance is adequate.
- If vehicle is detected by OVDS #2, driver is instructed by VMS to stop and await further direction.

If a vehicle is overheight, the Variable Message Sign (VMS) displays a sequence of messages instructing driver where or where not to park. The gate can be delayed from opening while messages are displayed.

**EXAMPLE:**

- Message 1: "STOP"
- Message 2: "VEHICLE TOO TALL"
- Message 3: "PARK LEVEL 1 ONLY" or "DO NOT ENTER"

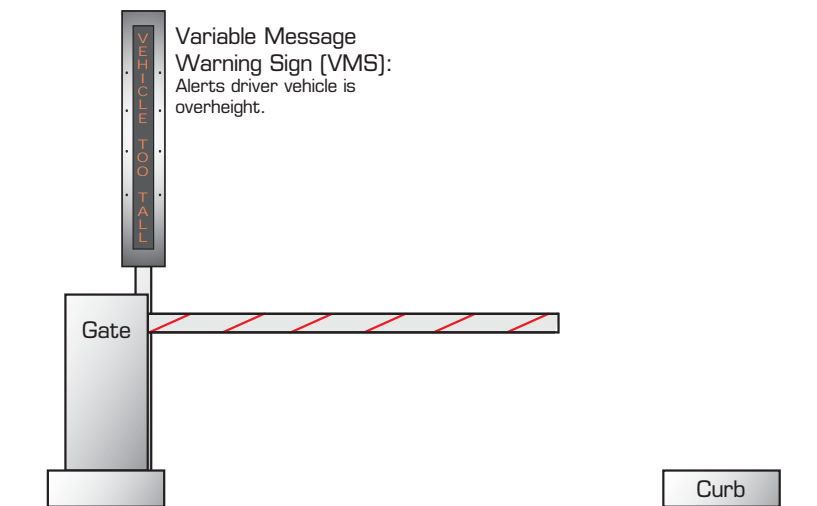
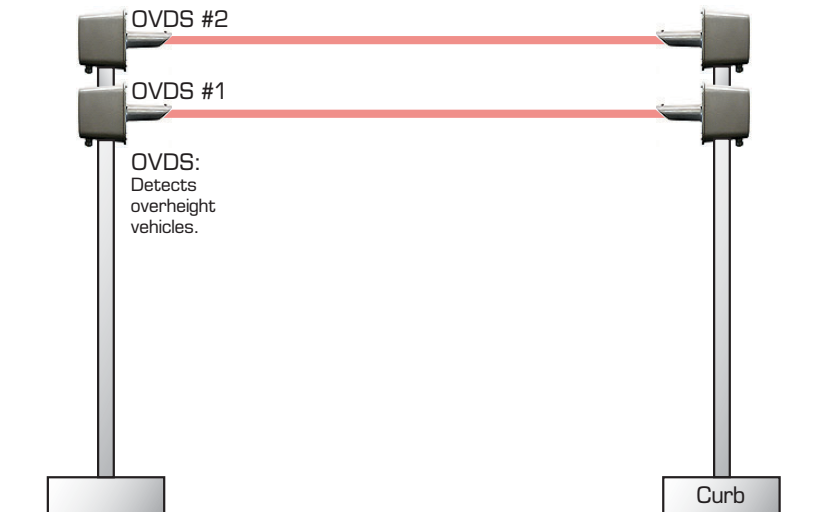
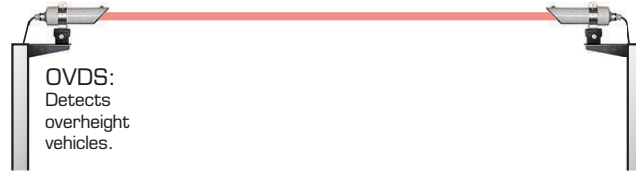

**Detectors**



Z-Pattern™



Double Eye



Single Eye



Metro Economy

**OVDS MODEL MATRIX**

Model No.	Features									
	Detection			Environmental		Direction	Alarm Time (Sec)		Options	
	Red	IR-A	IR-C	Heating	Cooling	Discerning	1 - 30	5 - 60	SE Mode	Fault Rptg
ME-R/301	X						X			
ME-R/305	X						X			
ME-R/310	X							**		
SE-R/3310 †	X			X			X			X
SE-IR/3311 †		X		X			X			X
DE-R/3110 †	X			X		X	X		X	X
DE-IR/3111 †		X		X		X	X		X	X
DE-Z/3400 †	X	X		X	X	X	X		X	X
DE-Z/3401* †		X-L	X-R	X	X	X		X	X	X
DE-Z/3402* †		X-R	X-L	X	X	X		X	X	X
DE-Z/3403 †	X	X		X	X	X		X	X	X

"X" Indicates features standard to the system.

\* Dual-System Configuration. Contact factory for application.

\*\* Constant alarm with object detection.

† Have Fault Reporting capability.

**LEGEND**

Symbol	Explanation
ME-R	Metro Economy, Visible Red
SE-R	Single Eye, Visible Red
SE-IR	Single Eye, Infrared
DE-R	Double Eye, Visible Red
DE-IR	Double Eye, Infrared
DE-Z	Double Eye, Z-Pattern™
IR-A	"A" Modulation frequency (Infrared)
IR-C	"C" Modulation frequency (Infrared)
-L	Left (Eye orientation within cabinet as viewed behind Master)
-R	Right (Eye orientation within cabinet as viewed behind Master)

**NOTES**

1.	All systems can be configured to operate with either 115VAC or 220VAC. Models 3401, 3402 and 3403 operate with both.
2.	All systems can be operated with solar power. The ME-R/301 will operate with 12VDC or 24VDC. All other solar powered systems operate with 24VDC.

**Specifications**

**Overheight Vehicle Detection System**

Double Eye Z-Pattern™\*  
Visible Red / Infrared  
Model #: **3400-Z**



\* PATENTED

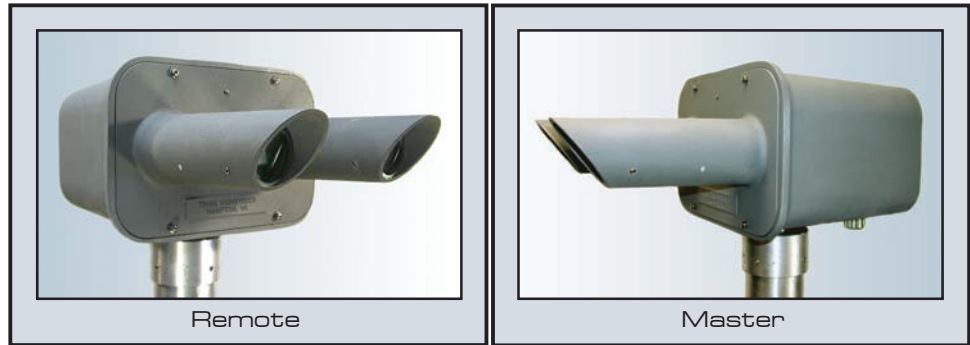

**Z-Pattern™**

INPUT POWER	115VAC, +/- 10%, 50/60HZ. Other options include 24VDC solar or 230VAC, +/-10%, 50/60HZ operation.
OUTPUT	Two Form C, dry relay contact closures for Overheight Alarm Functions. One Form C, dry relay contact closure for Fault Reporting. Contacts rated 115VAC 10A, protected by 8A circuit breakers.
FAULT REPORTING	Fault reporting output upon loss of source/detector power or total failure.
ALARM TIME	Adjustable by customer from 2 to 30 seconds.
ELECTRONICS	Sensors are NEMA 6P enclosure rated.
EFFECT OF AMBIENT LIGHT	Use of Dual Beam RED/IR "Z" Pattern provides automatic switch to Single Beam Detection Mode of Overheight Protection if the sun or other interference saturates one detector.
MAXIMUM RANGE	700 feet (213 m). Suggested maximum range 200 feet (61 m) to allow for bad weather and lens contamination.
DIRECTION SELECTION	Selection switch. No tools or adjustment required.
ALIGNMENT	Four LEDs and meter (GO-NOGO functions) provided for ease of alignment and testing.
REACTION SPEED	1 to 75 MPH (1 to 121 km/h) for a 2 inch (5 cm) diameter object 1 inch (3 cm) above the detection height. Custom speed/size available.
TEMPERATURE RANGE	-40° to +135° F (-40° to +57° C).
ENVIRONMENTAL CONTROL	Internal thermostat controls air flow which reduces moisture and maintains internal temperature during cold weather.
HOUSINGS	External housing is heavy ALMAG casting and sheet aluminum (not less than 1/8 inch or .318 cm thickness) for rugged durability and extended life. Cabinet design minimizes effects of vandalism and provides rigid mounting. The pole cap serves as a mounting bracket and sighting base with our poles. NEMA 3R Certified.
DIMENSIONS	Remote Cabinet: 12¾ x 16½ x 8½ inches (32 x 42 x 22 cm). Master Cabinet: 12¾ x 18¾ x 8½ (32 x 48 x 22 cm).
SHIPPING WEIGHT	60 lbs (27 kg).

**Specifications**

**Overheight Vehicle Detection System**

Double Eye Z-Pattern™\*  
Infrared / Infrared  
Model #: 3401-Z  
Model #: 3402-Z



\* PATENTED

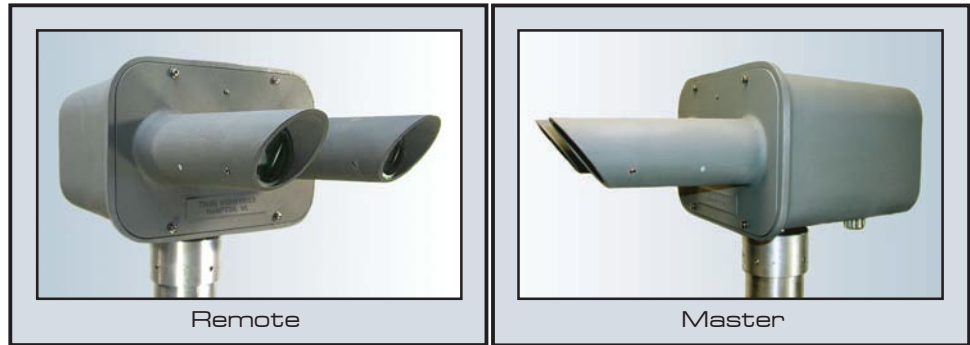

**Z-Pattern™**

INPUT POWER	115VAC, +/- 10%, 50/60HZ. Other options include 24VDC solar or 230VAC, +/-10%, 50/60HZ operation.
OUTPUT	Two Form C, dry relay contact closures for Overheight Alarm Functions. One Form C, dry relay contact closure for Fault Reporting. Contacts rated 115VAC 10A, protected by 8A circuit breakers.
FAULT REPORTING	Fault reporting output upon loss of source/detector power or total failure. Fault Relay toggles at one-second intervals during Single Eye Mode of operation.
ALARM TIME	Adjustable by customer from 5 to 60 seconds.
ELECTRONICS	Sensors are NEMA 6P enclosure rated.
EFFECT OF AMBIENT LIGHT	Use of Dual Beam IR/IR "Z" Pattern provides automatic switch to Single Beam Detection Mode of Overheight Protection if the sun or other interference saturates one detector.
MAXIMUM RANGE	700 feet (213 m). Suggested maximum range 200 feet (61 m) to allow for bad weather and lens contamination.
DIRECTION SELECTION	Selection switch. No tools or adjustment required.
ALIGNMENT	Four LEDs and meter (GO-NOGO functions) provided for ease of alignment and testing.
REACTION SPEED	1 to 75 MPH (1 to 121 km/h) for a 2 inch (5 cm) diameter object 1 inch (3 cm) above the detection height. Custom speed/size available.
TEMPERATURE RANGE	-40° to +135° F (-40° to +57° C).
ENVIRONMENTAL CONTROL	Internal thermostat controls air flow which reduces moisture and maintains internal temperature during cold weather.
HOUSINGS	External housing is heavy ALMAG casting and sheet aluminum (not less than 1/8 inch or .318 cm thickness) for rugged durability and extended life. Cabinet design minimizes effects of vandalism and provides rigid mounting. The pole cap serves as a mounting bracket and sighting base with our poles. NEMA 3R Certified.
DIMENSIONS	Remote Cabinet: 12¾ x 16½ x 8½ inches (32 x 42 x 22 cm). Master Cabinet: 12¾ x 18¾ x 8½ (32 x 48 x 22 cm).
SHIPPING WEIGHT:	60 lbs (27 kg).



**Specifications**

**Overheight Vehicle Detection System**

Double Eye Z-Pattern™\*  
Visible Red / Infrared  
Model #: **3403-Z**



\* PATENTED

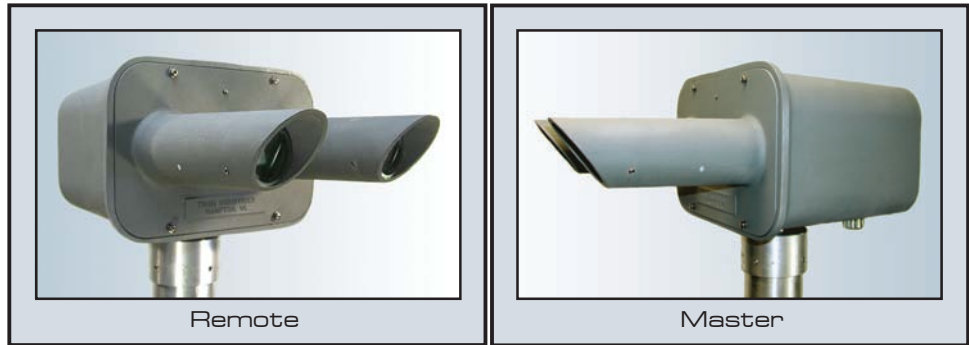

**Z-Pattern** 

INPUT POWER	115VAC, +/- 10%, 50/60HZ. Other options include 24VDC solar or 230VAC, +/-10%, 50/60HZ operation.
OUTPUT	Two Form C, dry relay contact closures for Overheight Alarm Functions. One Form C, dry relay contact closure for Fault Reporting. Contacts rated 115VAC 10A, protected by 8A circuit breakers.
FAULT REPORTING	Fault reporting output upon loss of source/detector power or total failure. Fault Relay toggles at one-second intervals during Single Eye Mode of operation.
ALARM TIME	Adjustable by customer from 5 to 60 seconds.
ELECTRONICS	Sensors are NEMA 6P enclosure rated.
EFFECT OF AMBIENT LIGHT	Use of Dual Beam RED/IR "Z" Pattern provides automatic switch to Single Beam Detection Mode of Overheight Protection if the sun or other interference saturates one detector.
MAXIMUM RANGE	700 feet (213 m). Suggested maximum range 200 feet (61 m) to allow for bad weather and lens contamination.
DIRECTION SELECTION	Selection switch. No tools or adjustment required.
ALIGNMENT	Four LEDs and meter (GO-NOGO functions) provided for ease of alignment and testing.
REACTION SPEED	1 to 75 MPH (1 to 121 km/h) for a 2 inch (5 cm) diameter object 1 inch above the detection height. Custom speed/size available.
TEMPERATURE RANGE	-40° to +135° F (-40° to +57° C).
ENVIRONMENTAL CONTROL	Internal thermostat controls air flow which reduces moisture and maintains internal temperature during cold weather.
HOUSINGS	External housing is heavy ALMAG casting and sheet aluminum (not less than 1/8 inch or .318 cm thickness) for rugged durability and extended life. Cabinet design minimizes effects of vandalism and provides rigid mounting. The pole cap serves as a mounting bracket and sighting base with our poles. NEMA 3R Certified.
DIMENSIONS	Remote Cabinet: 12¾ x 16½ x 8½ inches (32 x 42 x 22 cm). Master Cabinet: 12¾ x 18¾ x 8½ (32 x 48 x 22 cm).
SHIPPING WEIGHT	60 lbs (27 kg).

## Z-Pattern Design Notes

The Trigg Industries Z-PATTERN OVERHEIGHT VEHICLE DETECTION SYSTEM (OVDS) employs both a pulsed visible Red and Infrared source/detector pair of eyes.

As shown in Figure 1, "Z-Pattern" Concept, both Remote and Master cabinets contain a detector and pulsed source. All Control, Fault Detection and Alarm functions are contained in the Master cabinet. The Dual Beam Detection Mode provides for direction selection/discernment. Due to the "Z-Pattern" design, it is necessary to provide a two-conductor shielded cable between the Remote cabinet and the Master cabinet for the Remote detection signal input.

Fault detection circuits switch the OVDS to Single Beam Detection Mode if one beam should fail or be affected by the sun or other outside interference. The system will return to the Dual Beam Detection Mode after the temporarily impaired beam is back in normal operation for approximately 90 seconds. There is no direction discernment in the Single Beam Detection Mode but overheight detection is maintained.

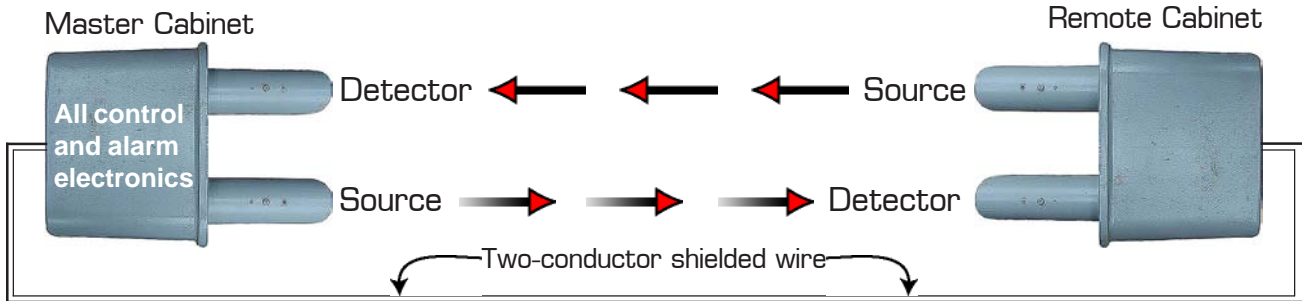

Figure 1. "Z PATTERN" CONCEPT

## Z-Pattern Installation Notes

If at all possible, position the cabinets so that the 'eyes' have a 10° angle from direct early morning or late afternoon sunlight.

Set the line of sight across the roadway, parallel (or as close as possible) to the slope of the road in the direction of interest. See Figure 2 (page 10), Cross Section of the Road.

The height of the detection zone should be adjusted down from the desired height until there are an excessive number of false alarms, then up until the false alarms disappear. This provides a practical adjustment for uneven roads.

Tilt the REMOTE and MASTER cabinets to make the plane described by parallel lines of sight between the REMOTE and MASTER eyes parallel to the roadway under the lines of sight in the direction of interest. See Figure 3 (page 10), View Across the Roadway.

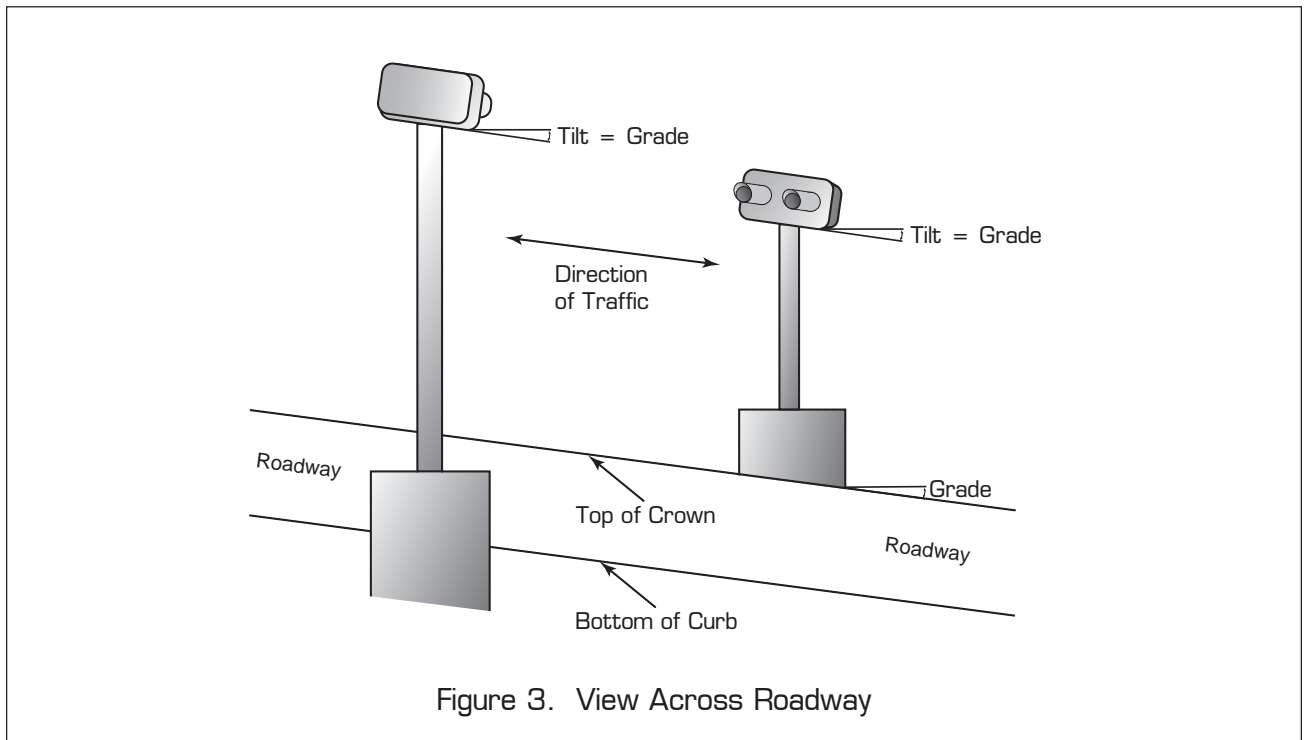
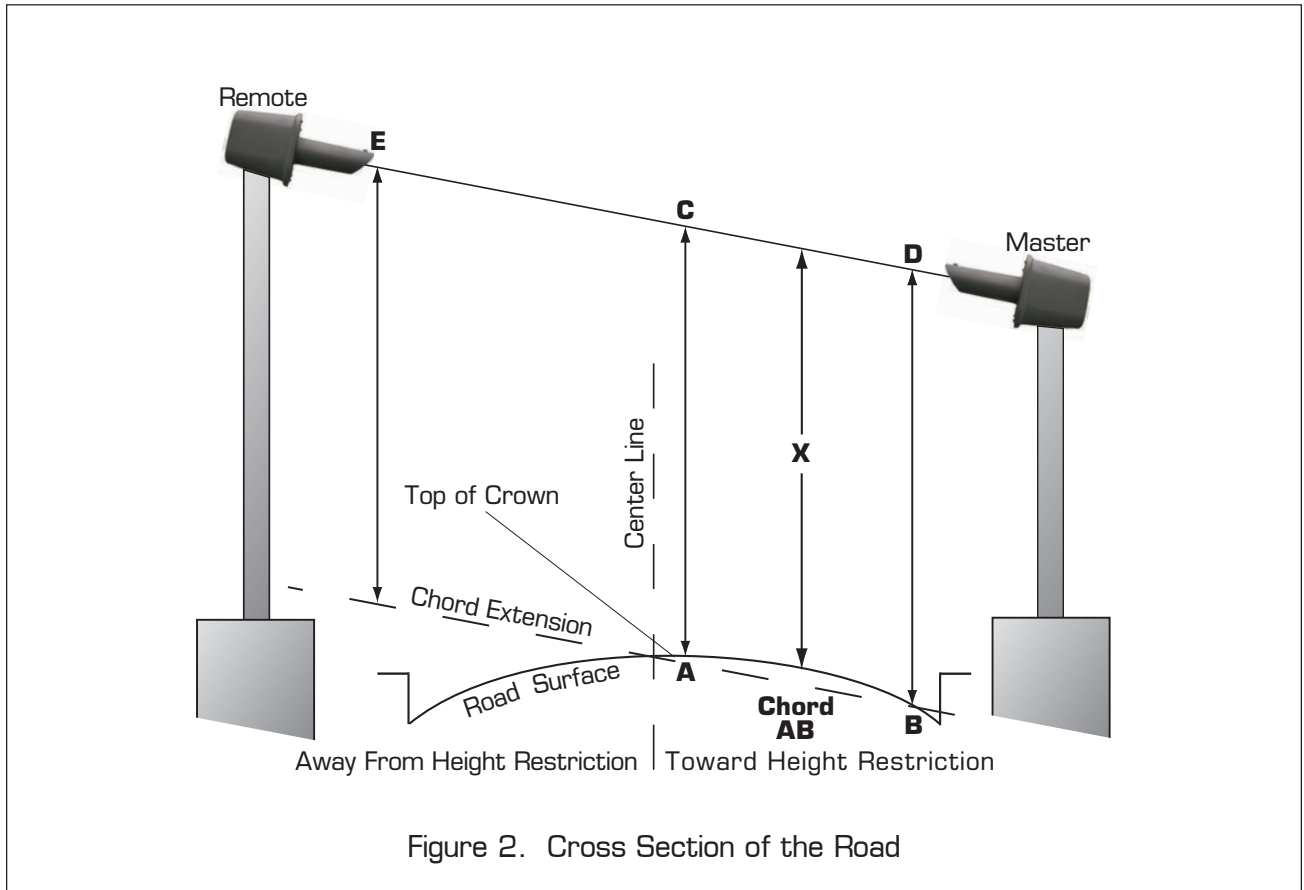

**Specifications**

**Overheight Vehicle Detection System**

Double Eye Visible Red  
**Model #: DE-R/3110**  
**Model #: DE-R/3110-S**  
 Double Eye Infrared  
**Model #: DE-IR/3111**  
**Model #: DE-IR/3111-S**



INPUT POWER	115VAC, +/- 10%, 50/60HZ. Other options include 24VDC solar or 230VAC, +/-10%, 50/60HZ operation.
OUTPUT	Form C, dry relay contact closure, contacts rated 115VAC 10A, protected by an 8A circuit breaker. System switches to Single Eye Mode of operation upon loss of either detector.
FAULT REPORTING	Fault reporting output upon loss of power, transmitter failure or either eye blocked for more than 13 seconds. Single Eye mode of operation implemented.
ALARM TIME	Adjustable by customer from 1 to 30 seconds. Custom alarm times available.
ELECTRONICS	Sensors are NEMA 6P enclosure rated. Electronic printed circuits for years of reliable operation.
EFFECT OF AMBIENT LIGHT	<b>DE-R/3110</b> - Sunlight immunity of 10,000 foot-candles. <b>DE-IR/3111</b> - Very high noise immunity.
MINIMUM RANGE	10 feet (3 m).
MAXIMUM RANGE	<b>DE-R/3110</b> - 800 feet (244 m). Suggested maximum range 200 feet (61 m) to allow for bad weather and lens contamination. <b>DE-IR/3111</b> - 700 feet (213 m). Suggested maximum range 200 feet (61 m) to allow for bad weather and lens contamination.
DIRECTION SELECTION	Selection switch. No tools or adjustment required.
ALIGNMENT	Two LEDs and meter (GO-NOGO functions) provided for alignment. No special tools required.
REACTION SPEED	1 to 75 MPH (1 to 121 km/h) for a 2 inch (5 cm) diameter object 1 inch (3 cm) above the detection height. Custom speed/size available.
COUNTER	Records the number of activation's.
TEMPERATURE RANGE	-40° to +135° F (-40° to +57° C).
ENVIRONMENTAL CONTROL	Internal thermostat controls air flow which reduces moisture and maintains internal temperature during cold weather.
HOUSINGS	External housing is heavy ALMAG casting and sheet aluminum (not less than 1/8 inch or .318 cm thickness) for rugged durability and extended life. Cabinet design minimizes effects of vandalism and provides rigid mounting. The pole cap serves as a mounting bracket and sighting base with our poles. Meets NEMA 3R intent.
DIMENSIONS	Transmitter: 15½ x 10 x 8¾ inches (39 x 25 x 22 cm). Receiver: 12¾ x 16½ x 8½ inches (32 x 42 x 22 cm).
SHIPPING WEIGHT	45 lbs (20 kg).

**Specifications**

**Overheight Vehicle Detection System**

Single Eye Visible Red  
**Model #: SE-R/3310**  
**Model #: SE-R/3310-S**  
 Single Eye Infraed  
**Model #: SE-IR/3311**  
**Model #: SE-IR/3311-S**

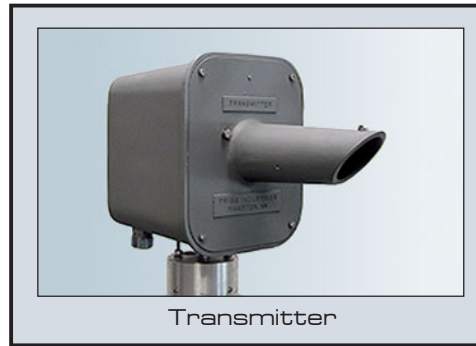

Transmitter

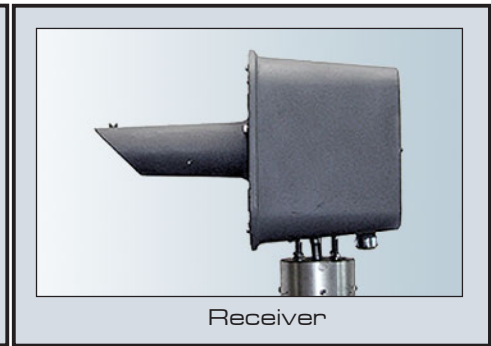

Receiver

INPUT POWER	115VAC, +/- 10%, 50/60HZ. Other options include 24VDC solar or 230VAC, +/-10%, 50/60HZ operation.
OUTPUT	Form C, dry relay contact closure, contacts rated 115VAC 10A, protected by an 8A circuit breaker.
FAULT REPORTING	Fault reporting output upon loss of power, source/detector failure or if beam is blocked for more than 13 seconds.
ALARM TIME	Adjustable by customer from 1 to 30 seconds. Custom alarm times available.
ELECTRONICS	Sensors are NEMA 6P enclosure rated. Electronic printed circuits for years of reliable operation.
EFFECT OF AMBIENT LIGHT	<b>SE-R/3310</b> - Sunlight immunity of 10,000 foot-candles. <b>SE-IR/3311</b> - Very high noise immunity.
MINIMUM RANGE	6 feet (2 m).
MAXIMUM RANGE	<b>SE-R/3310</b> - 800 feet (244 m). Suggested maximum range 200 feet (61 m) to allow for bad weather and lens contamination. <b>SE-IR/3311</b> - 700 feet (213 m). Suggested maximum range 200 feet (61 m) to allow for bad weather and lens contamination.
ALIGNMENT	One LED and meter (GO-NOGO functions) provided for alignment. No special tools required.
REACTION SPEED	1 to 75 MPH (1 to 121 km/h) for a 2 inch (5 cm) diameter object 1 inch (3 cm) above the detection height. Custom speed/size available.
COUNTER	Records the number of activation's.
TEMPERATURE RANGE	-40° to +135° F (-40° to +57° C).
ENVIRONMENTAL CONTROL	Internal thermostat controls air flow which reduces moisture and maintains internal temperature during cold weather.
HOUSINGS	External housing is heavy ALMAG casting and sheet aluminum (not less than 1/8 inch or .318 cm thickness) for rugged durability and extended life. Cabinet design minimizes effects of vandalism and provides rigid mounting. The pole cap serves as a mounting bracket and sighting base with our poles. Meets NEMA 3R intent.
DIMENSIONS	Transmitter: 15½ x 10 x 8¾ inches (39 x 25 x 22 cm). Receiver: 15½ x 10 x 8¾ inches (39 x 25 x 22 cm).
SHIPPING WEIGHT	40 lbs. (18 kg).

**Specifications**

**Overheight Vehicle Detection System**

Metro Economy Visible Red  
**Model #: ME-R/301**  
**Model #: ME-R/301-S**  
**Model #: ME-R/305**  
**Model #: ME/305-S**



INPUT POWER	115VAC, +/- 10%, 50/60HZ. Other options include 12/24VDC solar or 230VAC, +/-10%, 50/60HZ operation.
OUTPUT	Two form C dry relay contact closures. Contacts rated 115VAC 5A, protected by 5A fuses.
ALARM TIME	Adjustable by customer from 2 to 30 seconds. Other times available on request.
ELECTRONICS	Sensors are NEMA 6P enclosure rated. Electronics use printed circuit board for reliable operation.
EFFECT OF AMBIENT LIGHT	Sunlight immunity of 10, 000 foot candles.
MINIMUM RANGE	<b>ME-R/301</b> - 6 feet (2 m). <b>ME-R/305</b> - 1 foot (.31 m).
MAXIMUM RANGE	<b>ME-R/301</b> - 800 feet (244 m). Suggested maximum range 200 feet (61 m) to allow for bad weather and lens contamination. <b>ME-R/305</b> - 80 feet (24 m). Suggested maximum range 40 feet (12 m) to allow for bad weather and lens contamination.
ALIGNMENT	GO-NOGO green LED indicator provided for alignment. No special tools required.
REACTION SPEED	<b>ME-R/301</b> - 1 to 75 MPH (1 to 121 km/h) for a 2 inch (5 cm) diameter object 1 inch (3 cm) above the established height of detection. <b>ME-R/305</b> - 1 to 11 MPH (1 to 17 km/h) for a 2 inch (5 cm) diameter object 1 inch (3 cm) above the established height of detection.
HOUSINGS	Schedule 40 PVC shell and NEMA 6P eye enclosure.
SHIPPING WEIGHT	20 lbs (9 kg).

**Specifications**

**Overheight  
Vehicle  
Detection  
System**

Metro Economy  
Visible Red  
**Model #: ME-R/310**  
**Model #: ME-R/310-S**

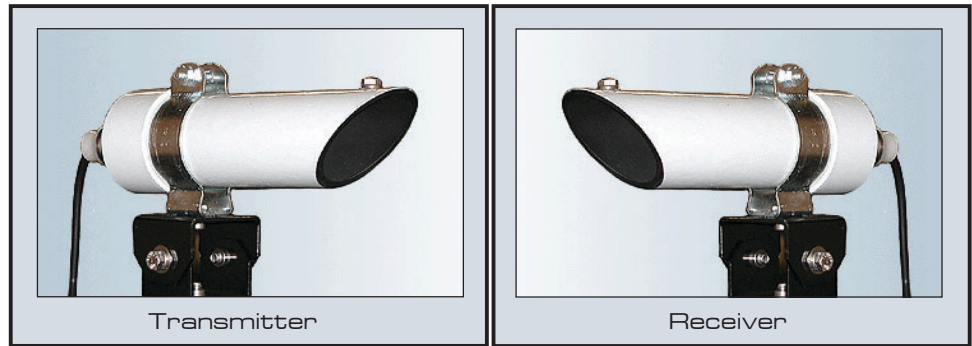

INPUT POWER	115VAC, +/- 10%, 50/60HZ. Other options include 24VDC solar or 230VAC, +/-10%, 50/60HZ operation.
OUTPUT	Two form C dry relay contact closures. Contacts rated 115VAC 5A, protected by 5A fuses.
ALARM TIME	Duration equal to time beam is broken.
ELECTRONICS	Sensors are NEMA 6 enclosure rated.
EFFECT OF AMBIENT LIGHT	Sunlight immunity of 10,000 foot candles.
MINIMUM RANGE	1 foot (.3 m).
MAXIMUM RANGE	80 feet (24 m). Suggested maximum range 40 feet (12 m) to allow for bad weather and lens contamination.
ALIGNMENT	GO-NOGO detector LED provided for alignment. No special tools required.
REACTION SPEED	1 to 11 MPH (1 to 17 km/h) for a 2 inch (5 cm) diameter object 1 inch (3 cm) above the established height of detection.
HOUSNGS	Schedule 40 PVC shell and NEMA 6 eye enclosure.
SHIPPING WEIGHT	20 lbs (9 kg).

## Warning Signs



Diamond Blank Out Style

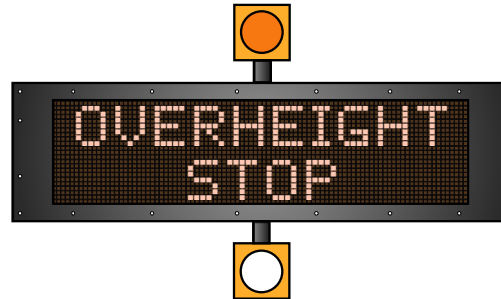

Variable Message Style [VMS]

WARNING SIGN MODEL MATRIX										
Model No.	Type	Features						Options		
		Program	Max # Lines	Characters		Sign Size	Weight	Flashers	Heater	Auto Dimmer
				Per line	Size					
3500	FB/BOS		Note 4	10 / 6	4" / 6"	63" X 63"	150lbs	X		
3501	FB/BOS		Note 5	10 / 8 / 5	2" / 3" / 4"	30" X 30"	100lbs	X		
3502	FB/BOS		2	18 / 12	4" / 6"	Note 9	175lbs	X		
3503	FB/BOS		2	14 / 10	2" / 3"		75lbs	X		
3505 *	LED/BOS	X	2	12	4.92"	18" X 66"	125lbs	X	X	X
3510	LED/BOS	X	3	12	4.92"	26" X 66"	150lbs	X	X	X
3515	LED/BOS	X	4	12	4.92"	34" X 66"	175lbs	X	X	X
3520	LED/BOS	X	4	12 / 24	9.84"/4.92"	64" X 126"	250lbs	X	X	X
3551 *	LED/BOS	X	1	16	2"	7.5" X 43"	25lbs		X	X
3552 *	LED/BOS	X	2	16	2"	10.5" X 43"	30lbs		X	X

Models 3505, 3551 and 3552 are also available in a vertical format. Custom signs available

All characters are Red/Yellow

All unites Power is either 115VAC or 220VAC

\* Programmable for vertical display.

NOTES	
1.	FB - Represents "Florescent Bulb" back lighting. The Model 3500 can use 4-8 bulbs and the 3501 uses a total of 4 bulbs.
2.	BOS - Indicates "Blank Out Sign" design capability.
3.	Models 3500 and 3501 are mounted in a diamond shape. Measurements are diagonal.
4.	Maximum lines for the Model 3500 is 3 @ 4" or 2 @ 6", 10 characters per line @ 4" and 6 characters per line @ 6".
5.	Maximum lines for the Model 3501 is 3 @ 2" or 2 @ 3" / 4" characters. 10 characters per line max at 2", 8 at 3" and 5 at 4".
6.	Flashers on LED signs are external, LED, 8" w/arrows or plain. They are custom mounted on top and bottom of sign or on either side. Model 3500 flashers are 12", internal, incandescent, w/reflectors. Model 3501 flashers are identical to the 3500 but 8".
7.	Heaters are 200W or 800W depending on size of sign and installation location.
8.	Models 3551 and 3552 are half-scale VMS signs. Custom sizes available upon request.
9.	These signs can be used in horizontal or vertical format. Model 3502: 20" X 102". Model 3503: 12" X 48".



**Specifications**

**Overheight  
Vehicle  
Detection  
System**

Blank Out Sign  
[with Alternating Flashers]

**Model #: 3500**  
**Model #: 3501**

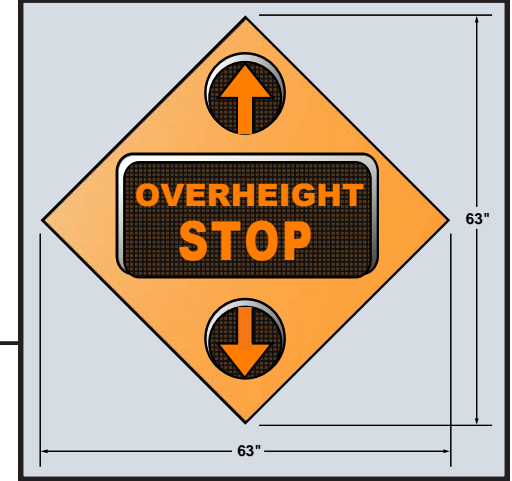
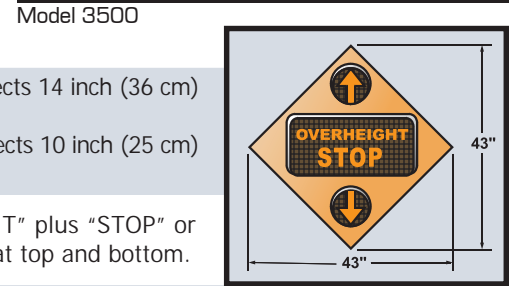
HOUSING	<p><b>3500</b> - 63 x 63 inch (160 x 160 cm) reinforced sheet aluminum (NLT .09) 2 cm. All aluminum and stainless steel with neoprene seats.</p> <p><b>3501</b> - 43 X 43 inch (109 X 109 cm) reinforced sheet (NLT .09) (2 cm). All aluminum and stainless steel with neoprene seats.</p>	 <p>Model 3500</p>
SUN SHIELD	<p><b>3500</b> - Sheet aluminum (NLT .060) (.15 cm) projects 14 inch (36 cm) to shield each element individually.</p> <p><b>3501</b> - Sheet aluminum (NLT .06) (.15 cm) projects 10 inch (25 cm) to shield each element individually.</p>	 <p>Model 3501</p>
FACING	<p>Blank out with desired message "OVERHEIGHT" plus "STOP" or "TURN RIGHT", etc. Alternating amber arrows at top and bottom.</p>	
ELECTRONICS	<p><b>3500</b> - 120VAC 50/60HZ operating four to eight rapid start florescent CWHO (high output) bulbs for message area and two 12 inch (30 cm) alternately flashing amber arrows.</p> <p><b>3501</b> - 120VAC 50/60HZ operating four rapid start florescent CWHO (high output) bulbs for message area and two 8 inch (20 cm) alternating flashing amber arrows.</p>	
MOUNTING	<p>V protections affixed to the back of the sign match upright supports. Heavy duty stainless steel straps provide horizontal stability.</p>	
SHIPPING WEIGHT	<p><b>3500</b> - 280 lbs (127 kg).</p> <p><b>3501</b> - 160 lbs (73 kg).</p>	

**Specifications**

**Overheight Vehicle Detection System**

Rectangular Blank Out Sign  
[with Alternating Flashers]

**Model #: 3502-H & 3502-V**  
**Model #: 3503-H & 3503-V**

**H** = Horizontal configuration  
**V** = Vertical configuration

HOUSING	<p><b>3502</b> - 20 x 102 inch (51 cm x 259 cm) reinforced sheet aluminum (NLT .09) 2 cm. All aluminum and stainless steel with neoprene seats.</p> <p><b>3503</b> - 12½ X 48 inch (32 cm X 122 cm) reinforced sheet (NLT .09) (2 cm). All aluminum and stainless steel with neoprene seats.</p>
SUN SHIELD	<p><b>3502</b> - Sheet aluminum (NLT .06) (.15 cm) projects 14 inch (36 cm) to shield each element individually.</p> <p><b>3503</b> - Sheet aluminum (NLT .06) (.15 cm) projects 10 inch (25 cm) to shield each element individually.</p>
FACING	Blank out with desired message "OVERHEIGHT" plus "STOP" or "TURN RIGHT", etc. Alternating amber arrows at top and bottom.
FLASHERS	Optional flashers with weatherproof enclosure mounted on either side/top and bottom of enclosure. Alternating flashers provides one second On-Off cycle.
ELECTRONICS	<p><b>3502</b> - 120VAC 50/60Hz operating four to eight rapid start florescent CWHO (high output) bulbs for message area.</p> <p><b>3503</b> - 120VAC 50/60HZ operating four rapid start florescent CWHO (high output) bulbs for message area.</p>
MOUNTING	V protections affixed to the back of the sign match upright supports. Heavy duty stainless steel straps provide horizontal stability.
SHIPPING WEIGHT	<p><b>3502</b> - 250 lbs (127 kg).</p> <p><b>3503</b> - 150 lbs (73 kg).</p>

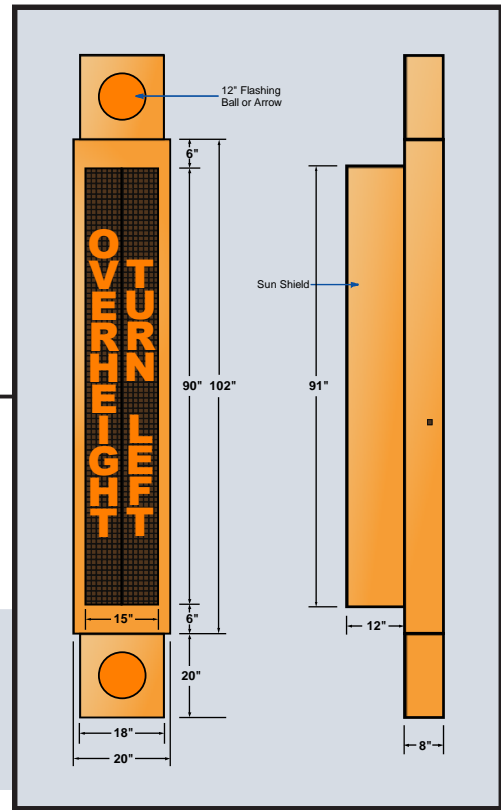

Model 3502-V

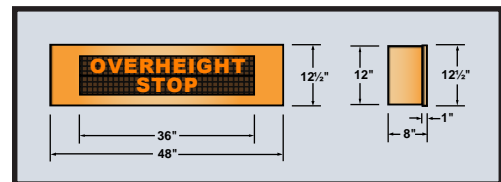

Model 3503-H

**Specifications**

**Overheight Vehicle Detection System**

LED Warning Sign  
Variable Message Sign (VMS)  
**Model #: 3551-H & 3551-V**

**H** = Horizontal configuration  
**V** = Vertical configuration

**SPECIFICATIONS FOR HIGH BRIGHTNESS RED OR AMBER LED**  
One Line VMS/BOS.

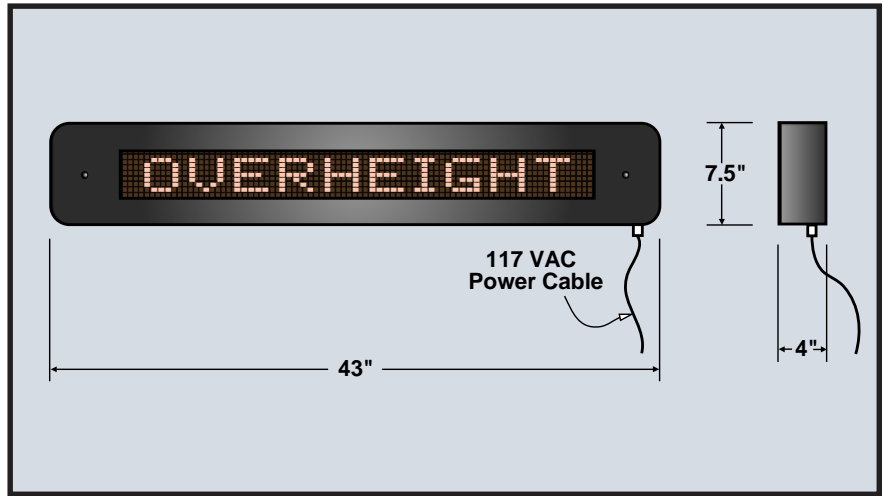

Model 3551-H

INPUT POWER	117VAC, +/- 10%, 50/60HZ at 1A. Other options include 24VDC solar or 230VAC, +/- 10%, 50/60HZ operation.
DISPLAY	16-character line with 2 inch (50 mm) high brightness, Red or Amber LED characters, message input provided by RS232 port. Up to 32,000 characters can be stored. Customer choice of 1200 mcd up to 2000 mcd brightness LEDs.
INPUT	Isolated LED On control from contact closure. Rapid turn-on of LED display.
EFFECT OF AMBIENT LIGHT	Acrylic non-glare face for greater readability.
TEMPERATURE RANGE	-30° to +130°F (-34° to 54° C)(with heater).
ENVIRONMENTAL CONTROL	Optional internal thermostat and heater maintains internal temperature during cold weather. Add 2A (200W) at 117VAC for heater power.
HOUSINGS	Weatherproof epoxy powder coat painted steel enclosure. IP65 rating.
MOUNTING	Wall mount standard. Pole mounting or other styles available.
DIMENSIONS	43 x 7½ x 4 inches (109 x 19 x 10 cm).
SHIPPING WEIGHT	25 lbs (11 kg).

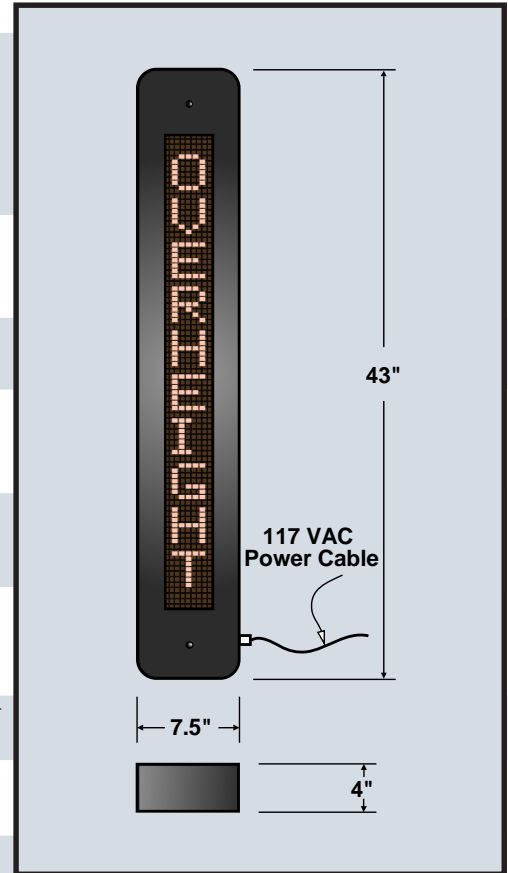

Model 3551-V

**Specifications**

**Overheight Vehicle Detection System**

LED Warning Sign  
Variable Message Sign [VMS]  
**Model #: 3552-H & 3552-V**  
**(V2 available in 3552-H only)**

**H** = Horizontal configuration  
**V** = Vertical configuration

**SPECIFICATIONS FOR HIGH BRIGHTNESS RED OR AMBER LED**  
Two Line VMS/BOS.

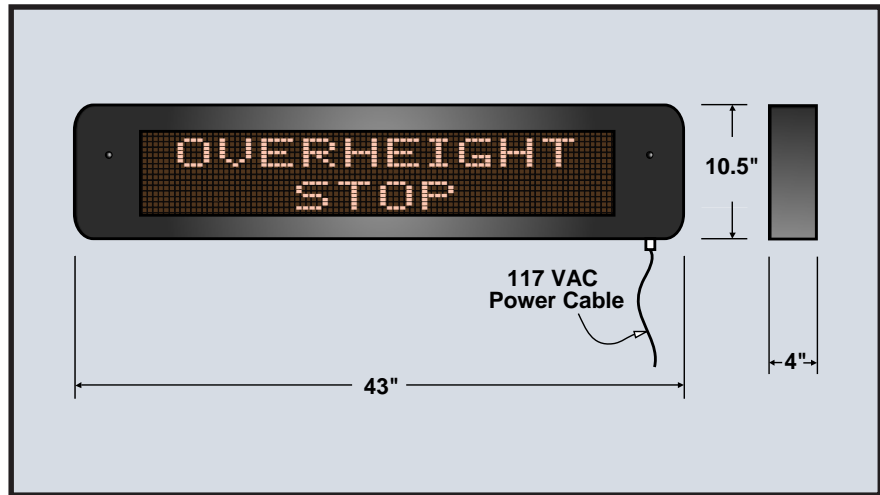

Model 3552-H

V1 Format - Message lines cannot be merged for larger characters.  
V2 Format - Message lines can be merged for larger characters.

INPUT POWER	117VAC, +/- 10%, 50/60HZ at 1A. Other options include 24VDC solar or 230VAC, +/- 10%, 50/60HZ operation.
DISPLAY	16-character line with 2 inch (50 mm) high brightness, Red or Amber LED characters, message input provided by RS232 port. Up to 32,000 characters can be stored. Customer choice of 1200 mcd up to 2000 mcd brightness LEDs.
INPUT	Isolated LED On control from contact closure. Rapid turn-on of LED display.
EFFECT OF AMBIENT LIGHT	Acrylic non-glare face for greater readability.
TEMPERATURE RANGE	-30° to +130°F (-34° to 54° C)(with heater).
ENVIRONMENTAL CONTROL	Optional internal thermostat and heater maintains internal temperature during cold weather. Add 2A (200W) at 117VAC for heater power.
HOUSINGS	Weatherproof epoxy powder coat painted steel enclosure. IP65 rating.
MOUNTING	Wall mount standard. Pole mounting or other styles available.
DIMENSIONS	43 x 10½ x 4 inches (109 x 27 x 10 cm).
SHIPPING WEIGHT	30 lbs (14 kg).

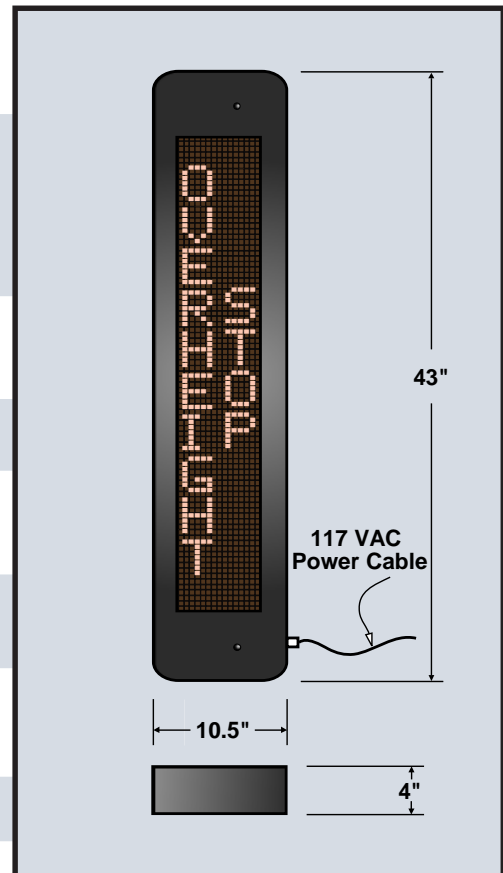

Model 3552-V

**Specifications**

**Overheight Vehicle Detection System**

LED Warning Sign  
Variable Message Sign (VMS)  
**Model #: 3505-H & 3505-V**

**V2 Format for H models only**

**H** = Horizontal configuration  
**V** = Vertical configuration

**SPECIFICATIONS FOR HIGH BRIGHTNESS RED OR AMBER LED**

Two line VMS/BOS.  
Alternating yellow flashers optional.

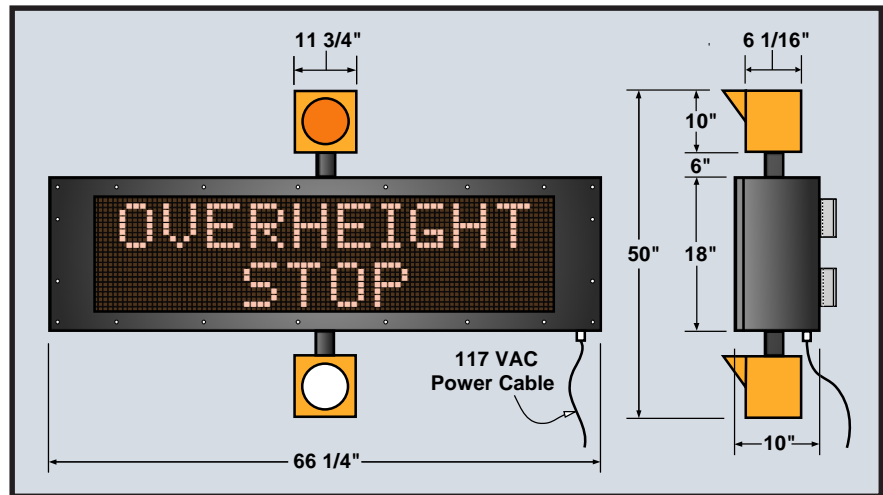

V1 Format - Message lines cannot be merged for larger characters.  
V2 Format - Message lines can be merged for larger characters

INPUT POWER	117VAC, +/- 10%, 50/60HZ at 2A. Other options include 24VDC solar or 230VAC, +/- 10%, 50/60HZ operation.
DISPLAY	12-character line with 4.92 inch (125 mm) high brightness, Red or Amber LED characters, message input provided by RS232 port. Up to three messages can be stored for user selection. Customer choice of 1000 mcd brightness LEDs with 30 degree viewing angle or 2000 mcd brightness LEDs with 15 degree 1/2 inch (1 cm) viewing angle. The 2000 mcd sign should be mounted so it faces about 15 degrees to the on-going traffic.
INPUT	Isolated LED On control from contact closure. Rapid turn-on of LED display.
FLASHERS	Optional 8 inch (20.32 cm) LED Yellow Ball with weatherproof enclosure mounted on each side of enclosure. Alternating flashers provides one second On-Off cycle. 8 inch (20 cm) LED Yellow Balls can also be mounted on the top and bottom of the sign (or omitted) if desired.
EFFECT OF AMBIENT LIGHT	Acrylic non-glare face for greater readability.
TEMPERATURE RANGE	-30° to +130°F (-34° C to 54° C) (with heater).
ENVIRONMENTAL CONTROL	Optional internal thermostat and heater maintains internal temperature during cold weather. Add 2A (200W) or 8A (800W) at 117VAC for heater power.
HOUSINGS	Weatherproof epoxy powder coat painted steel enclosure. IP65 rating.
MOUNTING	Wall mount standard. Pole mounting or other styles available.
DIMENSIONS	66¼ x 18 x 10 inch (168 x 46 x 25 cm) for enclosure. Add 16 inches (41 cm) to each side (or top/bottom) for the alternating flasher LEDs.
SHIPPING WEIGHT	125 lbs (57 kg).

**Specifications**

**Overheight Vehicle Detection System**

LED Warning Sign  
Variable Message Sign (VMS)

**Model #: 3510-H**  
**(V1 format)**

**H** = Horizontal configuration  
**V** = Vertical configuration

**SPECIFICATIONS FOR HIGH BRIGHTNESS RED OR AMBER LED**

Three line VMS/BOS.  
Alternating yellow flashers optional.

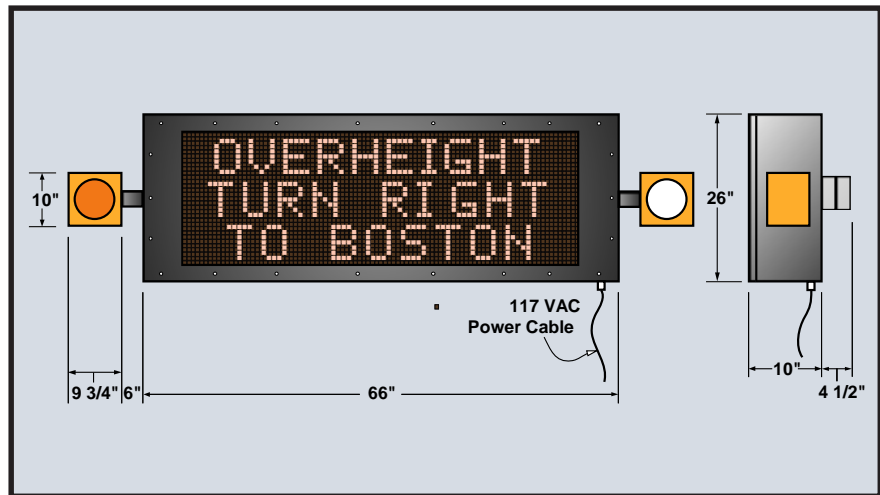

V1 Format - Message lines cannot be merged for larger characters.  
V2 Format - Message lines can be merged for larger characters

INPUT POWER	117VAC, +/- 10%, 50/60HZ at 3A. Other options include 24VDC solar or 230VAC, +/- 10%, 50/60HZ operation.
DISPLAY	12-character line with 4.92 inch (125 mm) high brightness, Red or Amber LED characters, all lines with V1 format, message input provided by RS232 port. Up to three messages can be stored for user selection. Customer choice of 1000 mcd brightness LEDs with 30 degree viewing angle or 2000 mcd brightness LEDs with 15 degree 1/2 inch (1 cm) viewing angle. The 2000 mcd sign should be mounted so it faces about 15 degrees to the on-going traffic.
INPUT	Isolated LED On control from contact closure. Rapid turn-on of LED display.
FLASHERS	Optional 8 inch (20 cm) LED Yellow Ball with weatherproof enclosure mounted on each side of enclosure. Alternating flashers provides one second On-Off cycle. 8 inch (20 cm) LED Yellow Balls can also be mounted on the top and bottom of the sign (or omitted) if desired.
EFFECT OF AMBIENT LIGHT	Acrylic non-glare face for greater readability.
TEMPERATURE RANGE	-30° to +130°F (-34° C to 54° C) (with heater).
ENVIRONMENTAL CONTROL	Optional internal thermostat and heater maintains internal temperature during cold weather. Add 2A (200W) or 8A (800W) at 117VAC for heater power.
HOUSINGS	Weatherproof epoxy powder coat painted steel enclosure. IP65 rating.
MOUNTING	Wall mount standard. Pole mounting or other styles available.
DIMENSIONS	66 x 26 x 10 inch (168 x 66 x 25 cm) for enclosure. Add 16 inch (41 cm) to each side (or top/bottom) for the alternating flasher LEDs.
SHIPPING WEIGHT	150 lbs (68 kg).

**Specifications**

**Overheight Vehicle Detection System**

LED Warning Sign  
Variable Message Sign (VMS)

**Model #: 3515-H (V1 format)**  
**Model #: 3520-H (V2 format)**

**H** = Horizontal configuration  
**V** = Vertical configuration

**SPECIFICATIONS FOR HIGH BRIGHTNESS RED OR AMBER LED**

Four line VMS/BOS.  
Alternating yellow flashers optional.

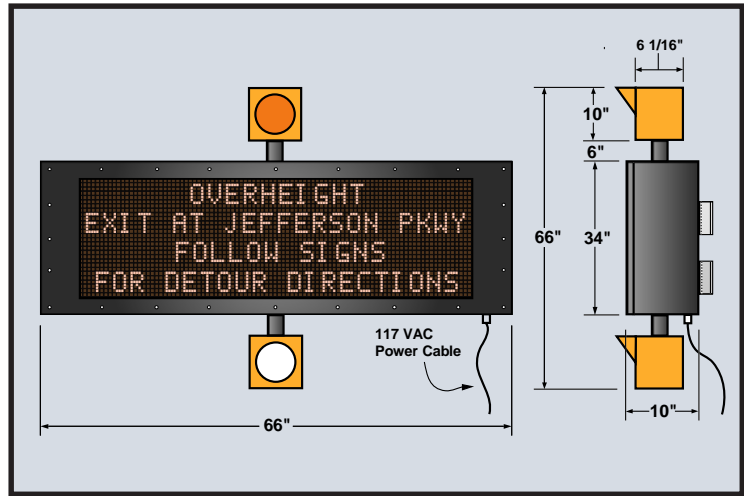

Model 3515-H

V1 Format - Message lines cannot be merged for larger characters.  
V2 Format - Message lines can be merged for larger characters.

INPUT POWER	117VAC, +/- 10%, 50/60HZ at 3A. Other options include 24VDC solar or 230VAC, +/- 10%, 50/60HZ operation.
DISPLAY	12-character line with 4.92 inch (125 mm) high brightness, Red or Amber LED characters, message input provided by RS232 port. Up to three messages can be stored for user selection. Customer choice of 1000 mcd brightness LEDs with 30 degree viewing angle or 2000 mcd brightness LEDs with 15 degree 1/2 inch (1 cm) viewing angle. The 2000 mcd sign should be mounted so it faces about 15 degrees to the on-going traffic.
INPUT	Isolated LED On control from contact closure. Rapid turn-on of LED display.
FLASHERS	Optional 8 inch (20 cm) LED Yellow Ball with weatherproof enclosure mounted on each side of enclosure. Alternating flashers provides one second On-Off cycle. 8 inch (20 cm) LED Yellow Balls can also be mounted on the top and bottom of the sign (or omitted) if desired.
EFFECT OF AMBIENT LIGHT	Acrylic non-glare face for greater readability.
TEMPERATURE RANGE	-30° to +130°F (-34° C to 54° C) (with heater).
ENVIRONMENTAL CONTROL	Optional internal thermostat and heater maintains internal temperature during cold weather. Add 2A (200W) or 8A (800W) at 117VAC for heater power.
HOUSINGS	Weatherproof epoxy powder coat painted steel enclosure. IP65 rating.
MOUNTING	Wall mount standard. Pole mounting or other styles available.
DIMENSIONS	<b>3515</b> - 66 x 34 x 10 inch (168 x 86 x 25 cm) for enclosure. Add 16 inch (41 cm) to each side (or top/bottom) for the alternating flasher LEDs. <b>3520</b> - 126 x 64 x 10 inch (320 x 163 x 25 cm) for enclosure. Add 16 inches (41 cm) to each side (or top/bottom) for the alternating flasher LEDs.
SHIPPING WEIGHT	<b>3515</b> - 175 lbs (79 kg). <b>3520</b> - 250 lbs (113 kg).

**Specifications**

**Overheight  
Vehicle  
Detection  
System**

Direction Oriented  
Alarm Bell

Model:  
**Model #: 3600**



INPUT	120VAC, 50/60Hz.
OUTPUT	Bells 101db at 10 feet (3 m) directed by parabolic shield. Sound reduced to 50 - 60% at sides and rear of bell by the parabolic shield, shield diameter: 38 inch (97 cm).
ADJUSTMENT	Adjustable mounting bracket provided. Other brackets provided as needed.
PARABOLA DIMENSIONS	38 inches (89 cm) in diameter.
ENVIRONMENTAL	All-weather, -31°F to +151°F (-35°C to +66°C), UL 464, CSA Certified.
SHIPPING WEIGHT	50 lbs (23 kg).

**Decible Test Results**

Distance From Parabolic Shield	Reading
10 feet (3.05 m)	101 db
30 feet (9.15 m)	90 db
70 feet (21.34 m)	82 db
100 feet (30.48 m)	76 db



**Specifications**

**Overheight  
Vehicle  
Detection  
System**

Mounting Poles

Models:

**Model #: 3701**

**Model #: 3702**

One piece, seamless round aluminum tube. Handhold is centered 18 inch [46 cm] above the bottom of the shaft and the cover is secured by stainless steel screws. Base flange is one piece cast aluminum socket with 8¼ inch [21 cm] bolt center. Poles are complete with all hardware, brackets, except base mounting bolts and nuts.

<p>DIMENSIONS</p>	<p><b>3701</b> - 10 - 16½ feet (3 - 5 m) Pole, Telescoping (two poles required for each system).  <b>3702</b> - 10 foot (3 m) Pole, One Piece (for Warning Bell and/or Warning Sign).</p>
<p>SHIPPING WEIGHT</p>	<p><b>3701</b> - 90 lbs (41 kg).  <b>3702</b> - 60 lbs (27 kg).</p>

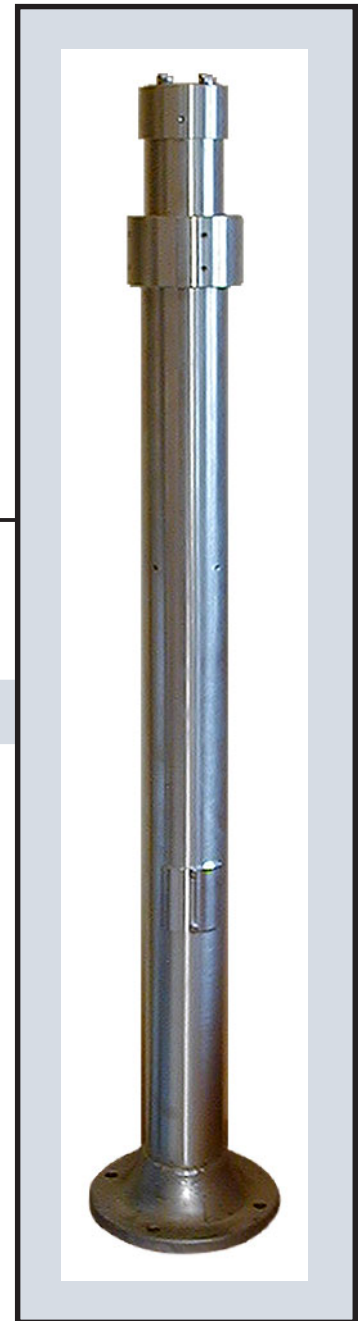

Model 3701

**Specifications**

**Overheight Vehicle Detection System**

3-Axis Mount  
**Model #: TGZ-M017**

Enables independant axis adjustments to match difficult crowns and contours of the roadway.



CONSTRUCTION	Three-piece mount of 9 mm 5052 aluminum, with stainless steel hardware.
ADJUSTMENT	Enables independent adjustment in Pitch +/- 40°, Roll +/- 40° and Heading +/- 60°.
ATTACHMENT	Designed for pole-top or pole-mount bracket installations via 5/8 inch (2 cm) stainless steel bolt.
DIMENSIONS	9 X 8½ X 3½ inch (23 x 22 x 9 cm).
WEIGHT	4 lbs (2 kg).

**Specifications**

**Overheight Vehicle Detection System**

Pole Mount Bracket  
**Model #: PMB-406**

- Adapts to any size pole or post
- Heavy Duty
- Easy Installation
- Ideal for OVDS and Warning Bell

SHIPPING WEIGHT	4 lbs (2 kg).
-----------------	---------------



**Specifications**

**Overheight Vehicle Detection System**

Loop Detector Interface  
**Model #: TGL-2001**

- Eliminates False Alarms
- Internal Alarm time adjustment
- Accepts most loop detector outputs
- Easy installation
- Internal loop hold adjustments

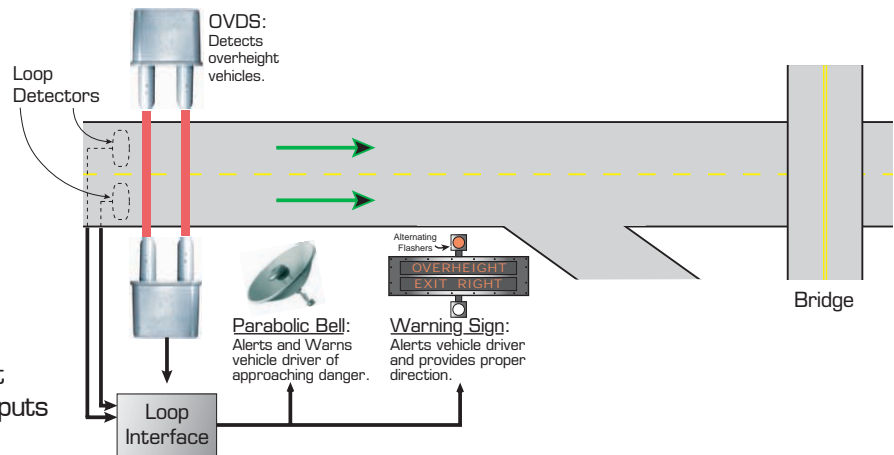

The Trigg Industries Loop Detector Interface insures that non-vehicular causes do not false-trigger overheight vehicle alarms. A loop detector [or detectors] in the roadway makes it possible to identify passage so that an overheight alarm is issued only when a vehicle is present. The interface is designed to accept a relay contact opening from a loop detector [or detectors] and a Trigg OVDS relay contact closure. The Model TGL-2001 includes a "Loop Hold" adjustment that allows for slower moving vehicles to be detected.

INPUT POWER	115 VAC +/- 10% Hz. Options include 24 VDC solar or 230 VAC +/- 10%, 50/60 Hz.
OUTPUT	Two Form C Dry relay contacts rated at 10A, protected by 8A fuses.
ALARM TIME	An Alarm Time adjustment is incorporated that allows a double-pole-throw relay to be energized from 1 to 30 seconds upon receiving a valid alarm. This feature enables the OVDS Alarm Time to be set for a short time (1 - 2 seconds), which in turn, allows control over alarm time.
ELECTRONICS	Heavy duty printed circuit board, terminal strips with Phillips screw connections.
TEMPERATURE RANGE	-40° to +135°F (-40° to +57° C).
HOUSING	All electronics are enclosed in PVC NEMA rated cabinet. Cord grips/strain relief connectors are included for cable access. The enclosure need not be mounted near either the loop relay(s) or OVDS but we do not suggest more than 500 feet (152 m) of separation due to the possibility of noise pickup in the cabling. Use of shielded cable may be required in some applications.
SHIPPING WEIGHT	20 lbs (9 kg).

Specifications

**Overheight Vehicle Detection System**

Radio Frequency Link  
**Model #: RFL-1001**

- Wireless cost effective alternative to cable installation
- Antenna options for custom applications
- License-free 900 Mhz transmission
- Mobility - System can be portable

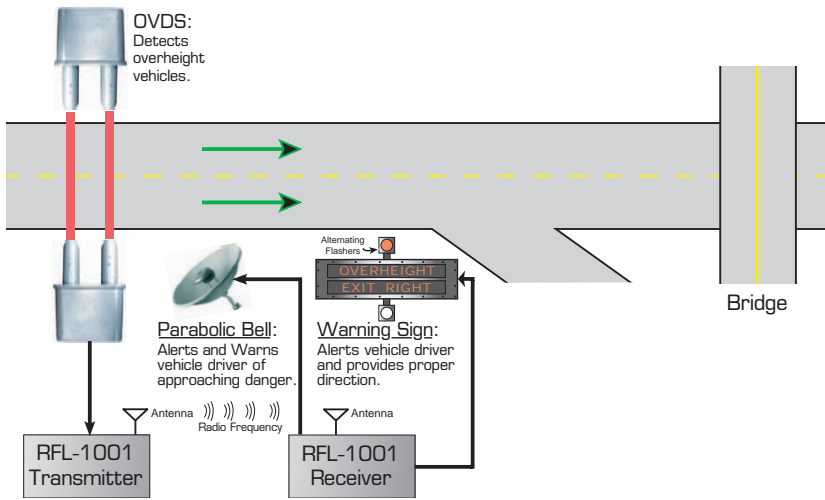

INPUT POWER	115 VAC +/- 10% Hz. Options include 24 VDC solar or 230 VAC +/- 10%, 50/60 Hz.
OUTPUT	Two Form C Dry relay contacts rated at 5A, protected by 5A fuses.
THROUGH-PUT	Approximately 1 second.
ELECTRONICS	Heavy duty printed circuit board for years of reliable operation.
TEMPERATURE RANGE	-40° to +135°F (-40° to +57° C).
HOUSING	Heavy duty PVC NEMA rated cabinet.
RANGE	OMNI Antenna - 1 mile (1.6 km). YAGI Antenna - 7 miles (11 km).
SHIPPING WEIGHT	20 lbs (9 kg).

**Specifications**

**Overheight Vehicle Detection System**

Solar Power Source

Model #: **SELS-2XX**

- Cost effective alternative to cable installation
- Can mix AC/DC in installation
- 21 consecutive sunless days capacity standard
- Rechargeable by generator

All Trigg Industries International, Inc., Overheight Vehicle Detection Systems (OVDS) can be operated with solar power. The operating voltage is 24 Volts DC for both the Transmitter and Receiver units. Custom configured for each geographic location [at least 7 times US Department of Energy requirements].

The solar power system consists of a solar panel assembly, batteries and solar control electronics. A 24VDC to 115VAC inverter can be included to supply 115VAC power for the Trigg Industries Warning Sign, Bell or other warning devices. The batteries, solar control electronics and inverter are mounted in vandal proof aluminum enclosures with inside the pole wiring. Mounting poles can be supplied or the customer can supply their own or use existing structures. Proper orientation of the solar panel assembly is necessary.

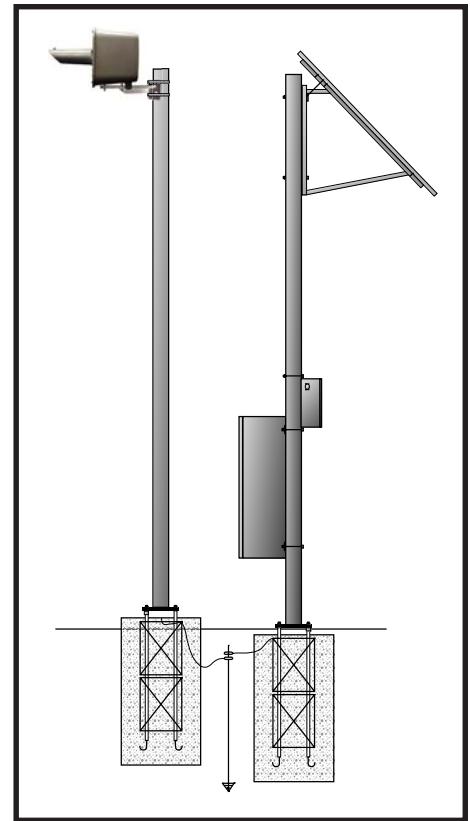

Solar power is a consideration where costs and/or substantial difficulties [trenching, right-of-way, etc.] are encountered in providing 115VAC power to one or both sides of the roadway. The Trigg Industries OVDS can be operated by a combination of solar power and 115VAC without system degradation.

OUTPUT	24 VDC.
ELECTRONICS	Enclosed in DOT grade stainless steel cabinet.
TEMPERATURE RANGE	-40° to +135°F (-40° to +57° C).
SHIPPING WEIGHT	Varies with system requirements.

Trigg Industries manufactures complete systems, including detectors, warning signs, alarms, mounting poles and all needed accessories. We build to meet US and International power requirements, as well as AC and Solar (DC) configurations.

Trigg Industries offers technical options to meet varying requirements and can provide cost effective solutions for virtually any overheight warning requirement. Custom systems can be provided as required.



SITE SELECTION CONSIDERATIONS		
	Consideration	Significance
1	What is the posted and practiced speed limit at the installation site?	Vehicle speed determines (in part) the distance from the warning sign the detector must be placed to provide sufficient time for drivers to react to directions given.
2	What exits, pull offs or U-turns are available between detector and obstruction?	Availability of such options must be taken into account as courses of actions for overheight vehicle drivers and directions given to them accordingly.
3	Is traffic one-way or two-way across the roadway the detection system will monitor?	Determines whether system must be direction discerning.
4	What are the number of lanes in the direction of interest?	May further determine distance required between detection and warning sign/exit if lane changing is involved.
5	What is the height of the obstruction (clearance required) and is there the same clearance for each lane?	The shape and/or contour of the obstruction or roadway may require more than one OVDS to monitor multiple heights or axis.
6	Are there any weather or airport radars within 1/4 mile of the OVDS installation site?	Since both the Visible Red and IR detectors are made from silicon substrate, it may be possible to generate a false alarm if the detector is looking directly into the radar.
7	What will be the smallest sun angles encountered with respect to the detectors' line of site?	The Visible Red detectors need a 3° clearance from direct sunlight and the IR detectors require an 8° clearance.
8	Is there 115VAC power available on both sides of the road at the installation site?	If AC power is not available, solar power may be an option. There can be a combination of both AC and solar power within the same system if necessary.
9	What is the desired alarm time?	This is the cumulative time requirement considering speed, distance, number of lanes and required driver response. Our systems offer 1-30 sec, 5-60 sec as a standard feature and custom times up to 5 minutes at no additional charge.
10	Is remote reporting of an overheight detection and/or fault condition required?	If so, this requirement dictates choice of system.
11	What are the local traffic patterns?	These may influence directions given to drivers in overheight situations.
12	<b>Trigg Industries would be pleased to discuss any overheight application.</b>	

**Worksheet of Suggested Specifications  
for  
Overheight Vehicle Detection  
and Warning System  
(OVDS)**



A System Designed for the Detection and Warning  
of Overheight Objects

## Preface

The purpose of this draft work sheet of specifications is to provide assistance and guidance to those preparing to provide warning, over and above those warnings required by state and federal law, to drivers of overheight vehicles or cargo loads.

The value of providing special warning to drivers of overheight vehicles is the prevention of accidents caused by driver error or inattention.

The most effective means found to date for providing special warning, is to individually alert the driver concerned and make them specifically aware that they will hit the low overhead object if they proceed.

In accidents caused by overheight vehicles, it is often the unoffending drivers and passengers of other vehicles, secondarily involved, that suffer the greatest injury. The fact that the driver of the overheight vehicle may be responsible and may pay for damages is of little importance in this event. The costs associated with the resolution of one accident even when involving a single vehicle generally exponentially exceed the cost of installing an Overheight Vehicle Detection and Warning System.

Answers to specific questions or assistance in planning solutions to exceptional problems is available on request from Trigg Industries.

Tel 757.851.3744

Fax 757.851.6583

[info@triggindustries.com](mailto:info@triggindustries.com)

[www.triggindustries.com/contacts.htm](http://www.triggindustries.com/contacts.htm)



# Preparation of Specifications

Suggestions to specification writer:

1. Read through these specifications, crossing out paragraphs and words that have no application to your problem.
2. Modify or add to the remaining text as your situation dictates.
3. Reread the final product to assure that all points are adequately covered in the manner prescribed by local law or practice.

## Specifications

### I. SCOPE

The design described herein is to prevent overheight vehicles/loads from striking the (bridge), (tunnel entrances), (etc.) by vehicles travelling (north-south bound), (east-west bound) on highway \_\_\_\_\_ in the direction(s) of \_\_\_\_\_ at point(s) \_\_\_\_\_.

Detection and warning items are to comply with (State) regulations and the (U.S. D.O.T. - F.H.D. Manual of Uniform Traffic Control) devices. All items shall be located to provide warning early enough (in consideration of "practiced vehicle speed" at the site) to allow sufficient time for driver to react. There should be maximum safety for all drivers with minimum disruption of traffic flows.

### II. GENERAL

A. All equipment shall be supplied to \_\_\_\_\_ for installation by \_\_\_\_\_. Each component of the equipment shall be accompanied by full instructions for installation, wiring, assurance of proper functional interface of components and other information needed for installation and functional testing.

### III. OPERATIONAL REQUIREMENTS

A. (State) legal requirements shall be met by inspection of or installation of standard signs as required by \_\_\_\_\_ (list if necessary) \_\_\_\_\_ . The necessary actions for this purpose shall be accomplished by \_\_\_\_\_ .

B. Warning of drivers of vehicles specifically detected as being overheight for clearance of the overhead structure shall be as follows:

1. DETECTION - All overheight vehicles or vehicle loads traveling toward the above described structure shall be detected and specific individualized warning shall be given. Vehicles traveling away from the structure shall be ignored by the detection equipment. Detection of vehicles traveling toward the structure shall be counted and recorded on an installed electronic counting device. The detection system shall consist of visible red or infra red source(s) and spectrally matching detector(s) mounted on poles positioned on opposite sides of the approach roadway at a distance of ( )feet(meters) from the structure. The alignment and height of the

visible red or infra red beam shall be preset to identify vehicles or loads of over ( )feet(meters) and ( )inches(cm)above the roadway at the line of detection.

*(NOTE FOR SPECIFICATION WRITER)* - The specified height should be the lowest clearance between the road surface and the overhead structure, less either the clearance required by state law or the allowance required for clearance after vehicle bounce etc. has been considered plus the amount deemed necessary for settling or margin of error.

2. ATTRACTION OF DRIVER ATTENTION - Positive action shall be taken to attract the attention of the driver to the fact that driver specifically will have an accident if driver proceeds. The action must cause him to become alert to the extent that he reacts as instructed. Caution should be taken to cause the least possible disturbance to other motorists and to minimize the adverse effects of increased ambient sound or light in the area.
3. WARNING AND INSTRUCTIONS FOR DRIVERS - of overheight vehicles shall be stated on the face of the warning sign and shall be illuminated internally, i.e., nature of danger "OVERHEIGHT" and action to be taken ("STOP" or "TURN RIGHT" or "EXIT RIGHT" or "USE RIGHT (LEFT) LANE," or "DO NOT ENTER" etc.)if the driver proceeds. The action must cause the driver to become alert to the extent that they react as instructed.

*(NOTE TO SPECIFICATION WRITER)* - If the instruction line on the sign is to read "STOP", there may be a need for an additional sign to instruct the driver on actions to take after they have stopped. This sign, if needed, should be located where the driver will see it unavoidably, after stopping. It should be in letters large enough for the driver to read but small enough not to attract the attention of drivers who are not involved. The theory behind the requirement for this sign is that the driver, who has been stopped, is possibly in a state of confusion and may act in such a way as to cause a new danger to other motorists.

#### IV. MATERIAL AND EQUIPMENT

##### A. GENERAL

1. Equipment is hereinafter referred to by manufacturer for the purpose of establishing standards of quality for Overheight Vehicle Detection and Warning Systems manufactured and/or supplied by Trigg Industries, are presently considered as acceptable when conditions of the drawings and specifications are met.

Products of other firms offered will be considered, subject to the Engineer's approval and will be based on the quality and capability of the substitutes compared to the equipment available from the above indicated supplier.

- 2. All equipment shall be constructed in a workmanlike manner and present a neat and finished appearance when completed. Proper operation of the equipment shall commence immediately after restoration of power.
- 3. Safety Features - NEMA 3R rated metallic equipment enclosures shall be provided with terminals for attachment of ground safety wire.

V. ENVIRONMENTAL REQUIREMENTS

A. METROLOGICAL CONDITIONS

The equipment shall operate and meet all of the requirements of this specification under the following atmospheric conditions:

Temperature	-40°F to 135°F (-40°C to 57°C).
Relative Humidity	0 to 100%.
Rain	2 inches per hour at 200 feet separation.
Snow	Light snow.
Fog	200 foot visibility.
Wind Velocity	0 to 90 miles per hour (0 to 144 km per hour).

B. SUNLIGHT

The equipment shall operate properly when the sun is outside 10 degrees of the extended optical axes of the receiver unit in its installed configuration. If the above requirements cannot be met, the equipment will be deemed satisfactory if explicit installation information is given such that the rays of the sun cannot interfere with the proper operation of the equipment. This provision includes reflections from vehicles.

C. CLOUDS

The variation in light intensity caused by the shadow of passing clouds shall not interfere with the proper operation of the equipment.

VI. MECHANICAL REQUIREMENTS

A. DETECTOR UNIT

The detector unit shall be solid state with printed circuit boards and regulated power supply. The unit shall be modular assembly type. It shall have an effective range of ten feet (10 ft)(3 m) to two hundred feet (38 m) with a reaction speed range of one (1)MPH (1.61 km/h)to seventy-five (75) MPH (121 km/h)for a 2 inch (5 cm)diameter object 1 inch (3 cm) above the detection height.

It shall contain provisions for the elimination of the effect of ambient light and an internal environmental control element that reduces operational failure from fog, condensation and insects. Dimensions shall not exceed a maximum overall size of 18 x 15 x 10 inch (46 x 38 x 25 cm). The housing shall be of cast Almag of not less than 1/8" thickness and shall be weather sealed. The mounting shall allow for directional adjustment and aiming after initial installation.

B. BORESIGHT

Two 1/8 inch (.32 cm) boresight holes are located at Top-Middle of each housing. Front and rear screws are installed in these holes so as to insure a weather tight enclosure, and should be removed to allow alignment of units. Looking through boresight hole from rear of unit so as to see through the boresight hole in front of unit gives the installer a basic means of aiming the unit in the proper direction. Focusing the unit on opposite sides of the road in the center of the front boresight while looking through the rear boresight hole ensures that a general alignment is accomplished. This step should be done from both Transmitter and Receiver Unit locations. Fine tuning of alignment can then be done electronically.

C. ACCESS

The transmitter unit and the receiver unit shall each be provided with a barrier to protect the operating equipment. The enclosure shall maintain its structural integrity for the operational life of the equipment and shall allow ready access for control adjustment and electrical interconnection without the use of any tools except a Phillips head screwdriver.

D. MOUNTING PROVISION

Each of the equipment units shall be provided with means for rigidly attaching the unit to a vertical cylindrical pole without requiring any machining operation. The attachment means shall not stress or deform the unit and shall prevent the movement of the unit in any direction by the force developed by wind. The mounting means shall allow adjustment of the vertical position on the pole. The mounting means for the transmitter unit and the receiver unit shall have the capability of adjusting the angular orientation of the optical axis in both the horizontal and vertical plane over an angular range of plus or minus five degrees from horizontal. The transmitter and receiver unit shall be mounted to detect the presence of vehicles that exceed the specified vertical height.

E. INTERNALLY ILLUMINATED SIGN(S)

Signs shall meet all electrical/electronic specifications stated in sub-paragraph IV.A.2 above and shall conform, in all essential elements, with the provisions of the U.S. D.O.T., F.H.A. Manual on Uniform Traffic Control Devices. Plastics on sign faces shall be protected by LEXAN™ or other material providing equal or greater defense against flying object damage or vandalism. Signs shall be activated and time controlled by the Detection unit. Lighting shall be provided by high output fluorescent bulbs for message and incandescent bulbs with parabolic reflectors for arrows at the top and bottom of sign.

F. SIGN HOUSING

Housing shall be a nominal 5 x 5 feet (2 m x 2 m) horizontal and vertical measurements as installed (diamond shape) reinforced aluminum capable of withstanding wind loading up to 90 MPH (144 km/h) and provided with a sun shield projecting at least 14 inch (36 cm). Letters and arrows shall be normally blanked out. When illuminated, arrows shall be amber in color, but can be made in any color specified.

G. PARABOLIC BELL ASSEMBLIES OR OTHER WARNING SOUND PRODUCING DEVICES

Shall be activated and time controlled by the Detection Unit. The Parabolic Bell is 38 inch (8 cm) in diameter and constructed of fiberglass. Electrical input shall be 115 VAC +/- 10%, at 50/60Hz. Parabolic Shields or other sound controlling directional devices shall be capable of withstanding wind loadings up to 90 MPH (144 km/h). Mounts shall be adjustable in vertical plane and adaptable for attachment as required herein.

H. UNIT MOUNTING POLES

Shaft - The shaft shall be a two piece, adjustable height, seamless, round aluminum tube. Poles shall include a handhole centered 18 inch(46 cm) above the bottom of the shaft. A cover, with stainless steel attachment screws, shall be provided for the handhole.

Base Flange - The base flange for the attachment of the shaft to the foundation shall be a one piece cast socket of aluminum alloy. Concrete footing and four anchor bolts shall be provided by\_\_\_\_\_

Pole Fittings - Must be specifically designed to accomodate the overheight detector, bells, signs, etc. specified herein whether supplied by the manufacturer of electronic components or of the poles. Poles come in two styles: 10 feet (3 m) non adjusting or 10 - 16½ feet (3 - 5 m)(adjusting (there are two pieces or shafts with this pole).

**NOTE TO SPECIFICATIONS WRITER**

Any sturdy pole or vertical structure can be used, including those already in position for other purposes. The above paragraph must be re-written to fit your plan keeping in mind the necessity for specifying how the equipment will be attached.

I. POWER AND SIGNAL CABLE CONNECTIONS

Power and signal cabling shall be provided between the receiver unit electronics and the junction box adjacent to the mounting pole foundation. Power for the receiver and transmitter units will be available at the junction box located adjacent to the mounting pole foundation and shall be made available by \_\_\_\_\_(WHOM) \_\_\_\_\_

J. WIRING

See attached "OVERHEIGHT WARNING SYSTEM CABLE WIRING DIAGRAM" and the above quality and performance specifications.

# Overheight Warning System Typical Cable Wiring Diagram

**OVDs**

## LEGEND

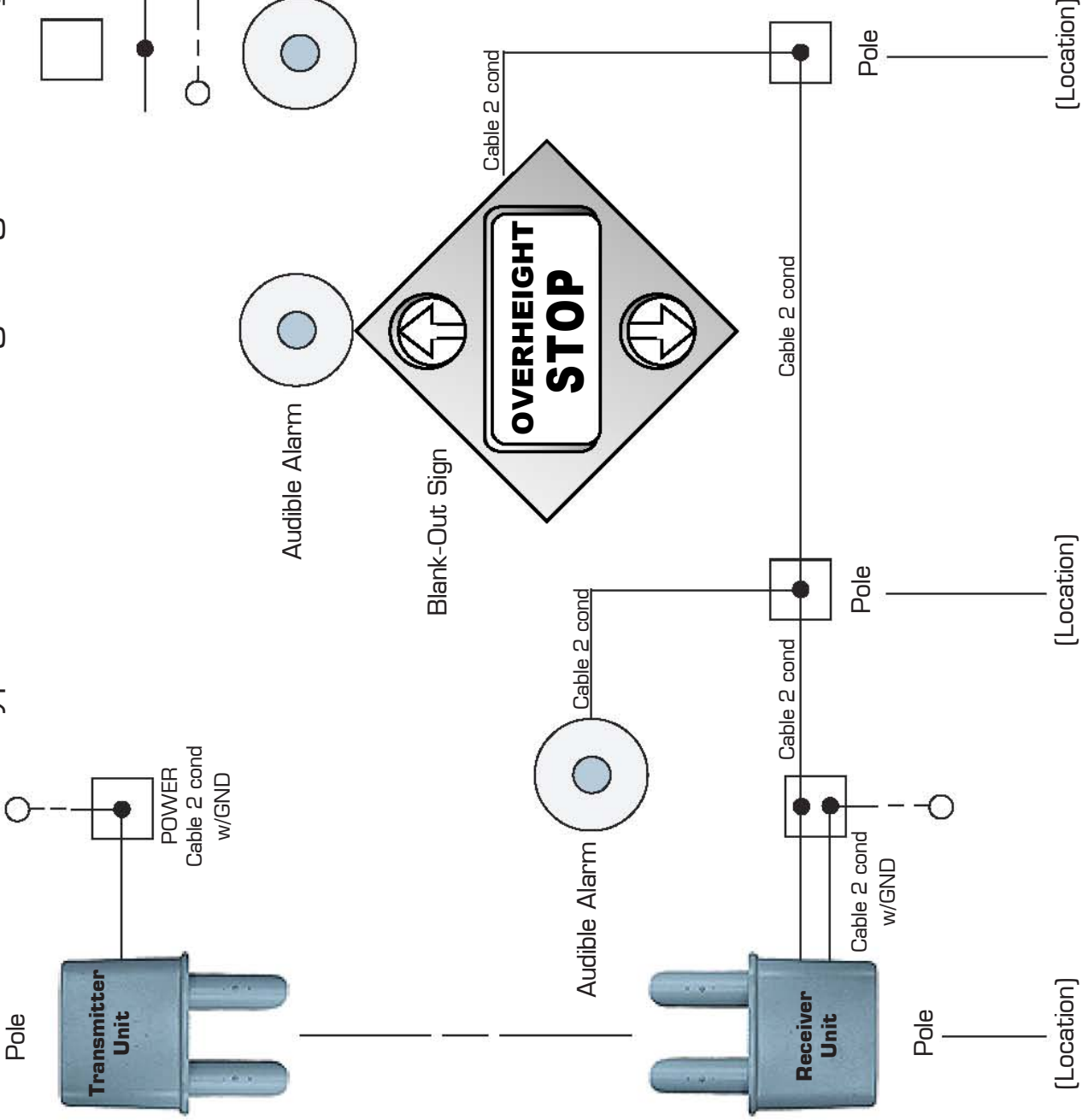
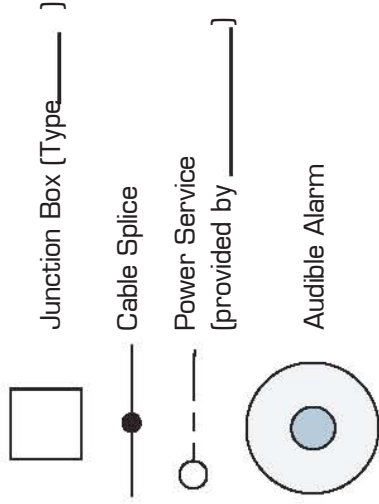

## CABLE:

- \*All power cable is AWG 12 COPPER.
- \*The number of conductors (COND) required is indicated.
- \*If spare cable COND are required or if more alert devices are added (or to be added), additional COND will be needed.
- \*All voltage requirements are 115 VAC ± 10%.



## Contacts

East Coast  
203 E. Mercury Blvd.  
Hampton, VA 23669  
Tel 757.851.3744  
Fax 757.851.6583

West Coast  
7007 Willoughby Ave.  
Los Angeles, CA 90038  
Tel 323.845.9390  
Fax 323.845.9503

<http://www.triggindustries.com>  
[info@triggindustries.com](mailto:info@triggindustries.com)

## Terms and Conditions

All government clients, open account net 30 days. Commercial clients net 30 days with approved credit. Visa and Mastercard accepted. All merchandise, unless otherwise specified, shipped UPS ground or specified carrier. Shipping is prepaid and added to invoice. Prices subject to change without notice.

## International Terms

All prices are in USD unless otherwise stated. UPS Worldwide Expedited, unless your own carrier is preferred. Orders are shipped 24 hours after receiving orders, except on holidays recognized in the USA or by UPS. Freight and cost of goods are pre-paid, in US funds. Customs and duty are your responsibility. All freight and cost of goods are pre-paid. Wire Transfer instructions are given at the time of order. Prices subject to change without notice. For quantities greater than those published online or in the catalog, please email, call or fax for quotation. Returned merchandise shipped COD, or merchandise returned without prior Returned Merchandise Authorization will not be accepted.

**Elwood**  
Tom Larson  
(414) 764-7500



## **R Series General Purpose LED Controls**

The R Series controls from Autotron represent the finest in general purpose photoelectrics. The rugged die cast metal case takes up only 57 cubic inches, making positioning and installing to best serve your production requirements a snap, as well as insuring long life. The R Series circuitry is field-tested with highly engineered solid state technology which provides years of trouble-free operation.

Modulated LED light allows uninterrupted operation under the brightest ambient light conditions. The indefinitely long life of the LED is unaffected by shock or vibration.

The flexibility and operation of the R Series is

guaranteed through engineering thoroughness which has gained UL listing. LED alignment is made simple by a visible proportional intensity indicator. Lens wear is reduced, and lens efficiency is enhanced through the use of recessed scratch resistant glass. Control functions are changeable through a series of plug-in cards. These cards along with a choice of plug-in output options make the R series the ultimate in modular flexibility.

All of these elements go into making R Series controls from Autotron a dependable and cost efficient work horse, whatever your counting, measuring, or sorting needs might be.

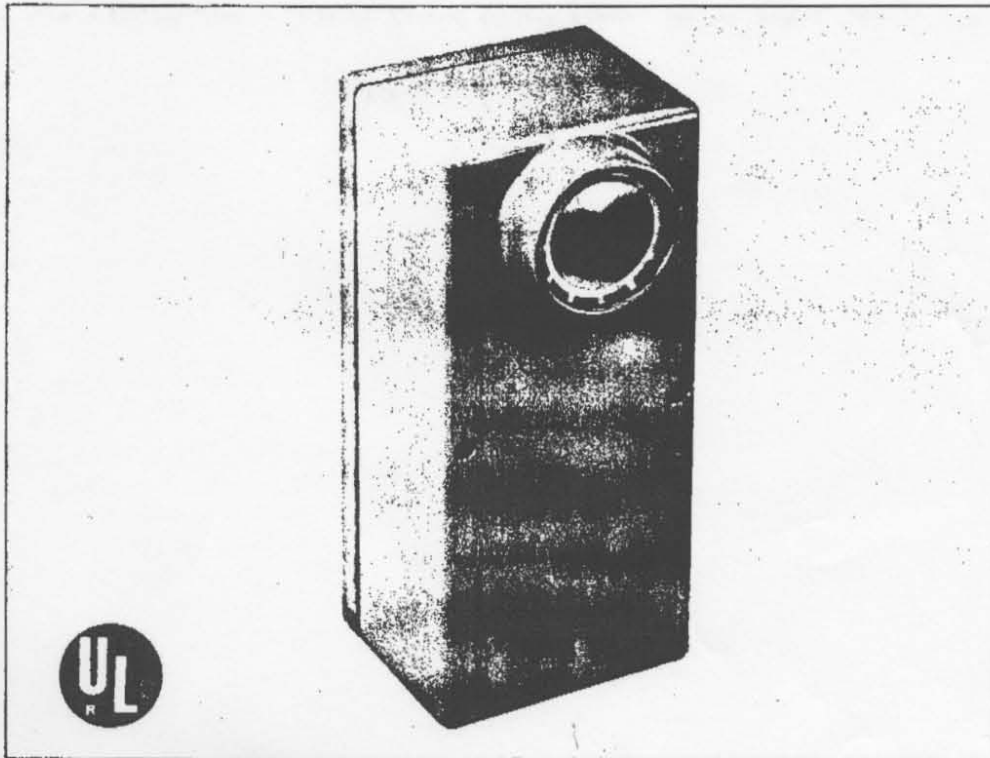

**Modulated LED Beam • Versatile**



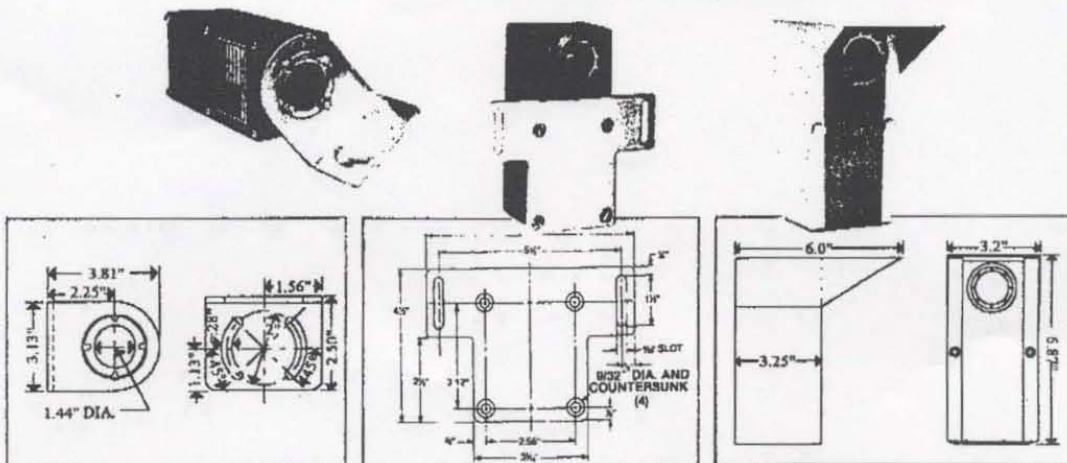

**P875 Universal Swivel Bracket Option**

- Allows rotation of control in all planes.
- 360° horizontal rotation.
- Made of heavy 7GA cad-plated steel.

**P961 Flange Mount Bracket Option**

- Allows a additional mounting capability.
- Acts as adapter bracket to A990 Series mounting.
- Made of 3/16" cad-plated steel.

**P1193 Weather Shield**

- Inhibits accumulation of rain, ice and snow on lens.
- Made of lightweight gold anodized aluminum.
- Stainless steel mounting bolts provided.

**METHODS OF DETECTION**

**RETRO-REFLECTION**

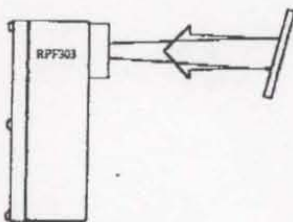

A retro-reflective control generally provides a surer, simpler and more positive detection in applications where a reflector can be used.

Retro-reflective controls project light through the control lens to a retro-reflective surface, which reflects the light directly back to the control lens. The reflective surface may be up to 15° from perpendicular, and may even be vibrating. Reflective discs are more efficient reflectors than retro-reflective tape.

The gain of the control is set so that the control will not respond to light reflected off of the object breaking the light beam. If the object is shiny or glossy, it may be necessary to angle the light beam so that it does not strike the object at right angles.

Retro-reflective models currently offered are —

Model No.	Operation	Range Off 3" Diameter Reflector†
RPF303	On/Off	0-35 feet

(See ORDERING INFORMATION on back page for list of optional plug-in function cards.)

Surface	Part No.	Max. Range
3" dia. reflector	P380	35 feet
1 5/8" dia. reflector	P380A	16 feet
1 1/4" dia. reflector	P380AB	14 feet
7/8" dia. reflector	P380B	12 feet
5/8" dia. reflector	P380C	10 feet
1 1/4" x 3" reflector	P380E	20 feet
1 1/4" x 4" reflector	P380F	20 feet
1" x 1" retro tape	7610	4 feet
1" x 1" retro tape	3870	3 feet
1" x 1" retro tape	7800	2 feet

**PROXIMITY (Diffuse Reflection)**



Proximity controls are primarily used in applications where retro-reflectors can not be used. They sense the presence of objects by bouncing light off of the object and detecting the diffuse reflected light. They are best suited to detect the presence or absence of objects, but can be used for color detection if there is enough contrast.

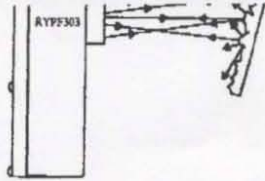

Proximity models currently offered are —

Model No.	Operation	Range Off 90% Diffuse White Surface†
RXPF303	On/Off	0-6 feet
RYPF303	On/Off	0-14 inches

(See ORDERING INFORMATION on back page for list of optional plug-in function cards.)

### THROUGH BEAM

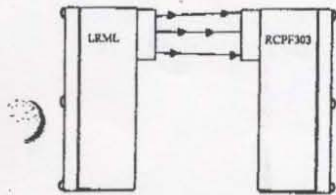

Through beam detection is generally considered better than retro or proximity detection because of greater sensing range and freedom from false detection of shiny objects. However, because of difficulty in alignment and the necessity of locating a separate light source, this method of detection is not used as often.

Through beam models currently offered are —

Model No.	Operation	Range†
RCPF303	On/Off Control	0-300 feet
LRML	Light Source	

(See ORDERING INFORMATION on back page for list of optional plug-in function cards.)

### HOW REFLECTIVITY AND DIRT AFFECT RANGE

The table below shows the typical reflectivity of various materials. This determines the minimum Excess Gain required for operation in clean air. Add additional Excess Gain for dirty environments.

Example: If material reflectivity requires an excess gain of 2 in clean air and your dirty environment requires an excess gain of 5, then you need an excess gain of 10 (2 x 5) to detect your material in your dirty environment.

Control operating range can then be determined from the RXPF303 and RYPF303 Excess Gain graphs on page 4.

Material	Typical Reflectivity	Required Excess Gain For Clean Air
Kodak White Test Card	90%	1.0
White Bond Paper	82%	1.1
Kraft Paper	80%	1.1
Clear White Pine Wood	75%	1.2
Black Polyester Cloth	25%	3.6
Old Black Conveyor Belting	16%	5.6
New Black Conveyor Belting	9%	10.0
3M Nextel Flatblack Paint	4%	22.5

**RULE OF THUMB:** When distinguishing one material from another, the ratio of one reflectivity to another should be 2:1 minimum.

†Maximum ranges apply for clean indoor conditions only. Contact the factory for dirty or outdoor applications.

### EXCESS GAIN

How well a photoelectric control can perform under less-than-ideal conditions is measured in terms of Excess Gain. Excess Gain is the ratio of the light signal available to the light signal necessary for the control to barely work. The graphs below plot this factor versus range from specific targets. If degrading factors such as dirt, a poorly reflective surface, or misalignment exist, an Excess Gain greater than one (1) is required. How much Excess Gain is required for the application is determined by the customer. An Excess Gain of 3-5 should be allowed for light industrial environments, and 5-8 for moderately dirty environments.

**TYPICAL EXCESS GAIN vs. RANGE**  
**RPF303**

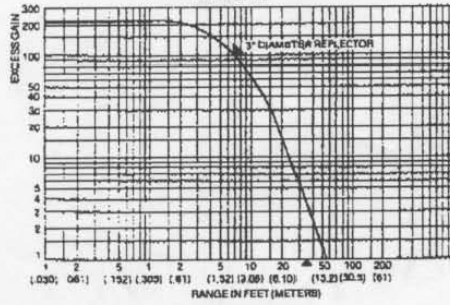

**RXPF303**

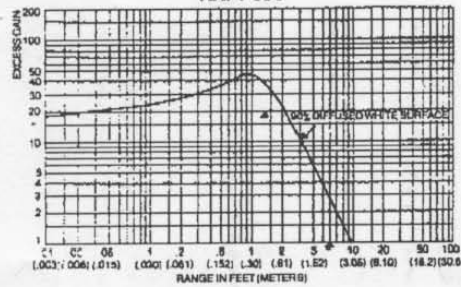

**RYPF303**

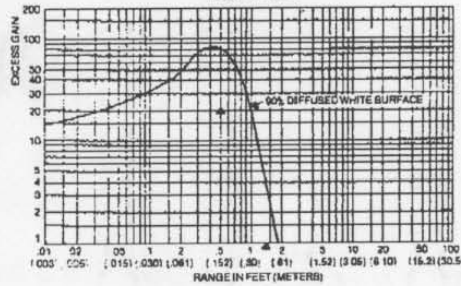

**RCPF303 / LRML**

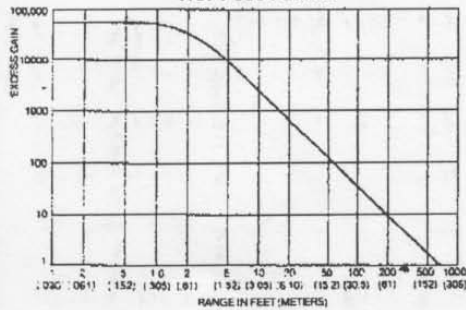

**EFFECTIVE BEAM DIAMETER vs. RANGE**

**RPF303**

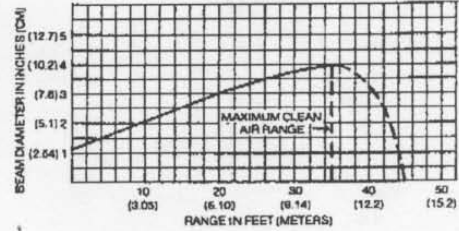

**RXPF303**

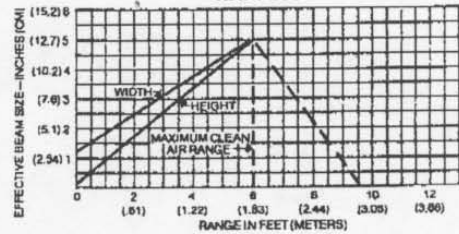

**RYPF303**

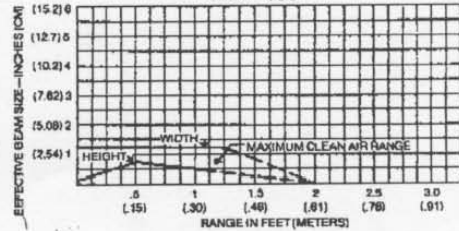

**RCPF303 / LRML**

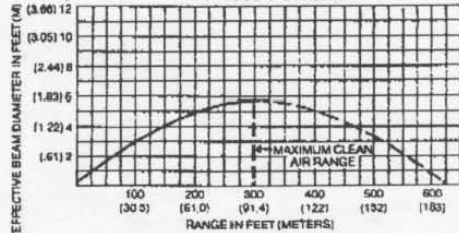

\* EFFECTIVE BEAM DIAMETER is defined as that portion of the radiation pattern that is sufficiently intense for detection.

**FEATURES**

- Multitude of industrial uses.
- Modulated LED beam. Highly immune to ambient light. Indefinitely long life.
- Plug-in relay and function cards interchangeable with other AUTOTRON Series. No card required for ON/OFF.
- Unique proportional intensity red LED alignment indicator. The better the alignment-the brighter it glows. Visible from outside of case.
- Compact, rugged die cast metal case, gasket sealed. Provides maximum shielding from electrical noise. Heavy epoxy paint protects against solvents and corrosive agents.
- Cover held tightly by six captive screws. Lip on cover prevents gasket "blow in" by external high pressure wash down.
- Metal case holds shape. Does not deform when hot or shatter when cold.
- Recessed glass lens resists scratching.
- False trip protection when power is turned on.
- Adjustable sensitivity is standard.
- Output phase selection is standard.

**APPLICATION**

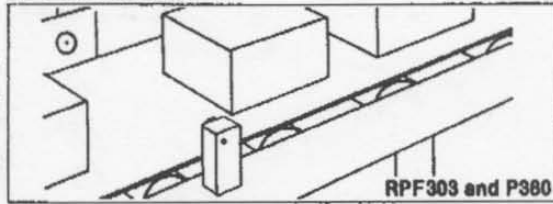

**OPTIONS**

- P875 Universal swivel bracket.
- P961 flange mount bracket.
- Plug-in logic or solid state AC switch output.
- P960 weather shield.
- Anti-fog lens heater for extreme environments.
- Optional input voltages:
  - 12 VAC 50-60 Hz
  - 24 VDC
  - 12 VDC
  - 230 VAC 50-60 Hz
  - 24 VAC 50-60 Hz
  - 120 VAC 50-60 Hz

**SPECIFICATIONS**

**Light Beam Distance** - See page 3.  
**Input** - 120V ± 10% 60Hz  
**Power Consumption** - 5VA  
**Response Time** - .01 sec. for circuit .03 including relay.  
**Output-Relay**; DPDT Contacts Rated 10A. 120 VAC resistive  
**Lamp** - GaAs infrared LED. Life-indefinitely long  
**Sensor** - Silicon phototransistor

**Ambient Operating Temperature Range** -40°F to +131°F (-40°C to +55°C)  
**Ambient Light Tolerance** - 10,000 foot candles  
**Enclosure** - Die cast aluminum epoxy gray painted gasket-sealed, NEMA 1, 3, 4, 5, 12, 13, tapped in bottom for 3/4" conduit  
**Shipping weight** - 3 lbs.  
**For more details ask for R Series Owner's Manual (Bulletin 178)**

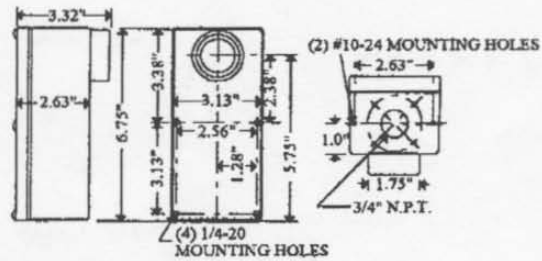

**ORDERING INFORMATION**

**CONTROLS**

Model No.	Description	Price
RPF303	ON/OFF Retro. Control	\$251.50
RXPF303	ON/OFF Prox. Control	\$276.50
RYPF303	ON/OFF Prox. Control	\$276.50
RCPF303	ONN/OFF Long Range Control	\$231.50
LRML	Long Range Light Source	\$158.00
A678R	Counting Control Pak	\$576.00

For ordering and pricing above Model Nos. with plug-in function cards installed, substitute the Function Card No. for 'F303' and add the card price.

For example, the RPF 303 On/Off Control with the T360 Single Timer Card installed is ordered as:

RPT360 Timing Control: \$295.75

**PLUG-IN FUNCTION CARDS**

Model No.	Function	Price
T360	Single Timer, OFF Delay	\$44.25
T310	Single Timer, ON Delay	\$44.25
T330	Dual Timer	\$73.25
T320	One-Shot Timer	\$56.25
T300	Five Function Timer	\$89.25
T342	Two-Digit Batch Counter	\$99.25
T370	Delayed One-Shot Timer	\$81.25
T380	Shift Register	\$81.25
T390	Over or Under Speed Detector	\$71.25
T399	Output Latch	\$44.25
T1330	Repeat Cycle Timer	\$73.25
T349	Single-Digit Toggle Batch Counter	\$89.25

For time delays from 30 secs. to 40 hrs. Consult factory for time ranges.

T320	Long Delay One-Shot Timer	\$81.25
T3600	Long Delay Single Timer, OFF Delay	\$81.25

For more Function Card details, see Bulletin 979.

**TIMING RANGES** (Do not use for T3200 or T3600.) Timing Ranges are specified in the last digit of the model number. The standard ranges are shown.

Range	No. 0:	No. 1:	No. 2:	No. 3:	No. 4:	No. 5:	No. 6:	No. 7:	No. 8:	No. 9:
	.1--10 sec.	.005-.5 sec.	.01-1 sec.	.02-2.5 sec.	.1-10 sec.	.005-.5 sec.	.01-1 sec.	.02-2.5 sec.	.1-10 sec.	.005-.5 sec.

Others available upon request.

**ACCESSORIES (ORDER SEPARATELY)**

Model No.	Description	Price
P380*	3" Diameter Reflector	\$5.50
P380A	1 5/8" Diameter Reflector	\$5.50
P380AB	1 1/4" Diameter Reflector	\$4.50
P380B	7/8" Diameter Reflector	\$4.25
P380C	5/8" Diameter Reflector	\$4.00
P380MH*	3" (metal housing) Reflector	\$7.50
P380E	1 1/4" x 3" rectangle Reflector	\$4.00
P380F†	1 1/4" x 4" rectangle Reflector	\$4.50
3870 Tape	2" wide	.45/in.

**Brackets and Shield**

Model No.	Description	Price
P875	Swivel Bracket	\$11.50
P961	Flange Mount Bracket	\$14.50
P1193	Weather Shield	\$20.50

**OPTIONAL FEATURES (Consult factory for model designation)**

Description	Price Adder
12VAC 50-60 Hz Input (A)	\$10.00
12VDC Input (D)	\$10.00
24VAC 50-60 Hz Input (B)	\$10.00
24VDC Input (W)	\$10.00
230VAC 50-60 Hz Input (E)	\$10.00
120VAC 50-60 Hz Input (T)	\$10.00
Plug-in AC Switch Output (K)	\$34.00
Plug-in Logic Output (G or GA)	\$16.00
Anti-fog Lense Heater (H)	\$20.00

Prices Subject to Change Without Notice



**ELWOOD CORP.-AUTOTRON GROUP**  
 195 W. RYAN ROAD • OAK CREEK, WI 53154-4401 • 414-764-7500  
 TOLL FREE 800-637-2648 • FAX 414-764-4298

Bulletin 593  
May, 1993

# Photoelectrics For Vehicle Washes



**L255HR**  
Light Source



**A978HR**  
Control

The AUTOTRON A978HR Control and L255HR Light Source are designed for top performance in severe environments. This set is a modified version of our R Series through-beam configuration which has been field proven for many years. We have added even more features to provide the highest degree of reliability in the toughest applications.



**P875**  
Swivel Bracket



**P960**  
Weather Shield

## FEATURES

- Die cast metal factory-sealed case.
- Sensitivity is adjustable from outside the case. No need to open control.
- Quick disconnect receptacle is factory installed for ease of installation and replacement.
- Electro-static powder coating of entire case to resist solvents and corrosion.
- Lens heater to help prevent lens fogging.
- Recessed scratch-resistant glass lens.
- Corrosion-resistant circuit coatings.
- Pulsed LED light source for indefinitely long life and high immunity to ambient light.
- Weather shield for additional protection.
- Universal swivel bracket is optional.

## ORDERING INFORMATION

One Set Contains	Model No.	Description	Price
1	A978HR	On/Off Control	\$250.00
1	L255HR	LED Light Source	178.50
2	P875	Swivel Bracket (optional)	9.00 ea
2	P960	Weather Shield (optional)	16.50 ea

Mating plug/cable assembly must be ordered separately  
Quantity discounts available  
Prices subject to change without notice

## SPECIFICATIONS

**Light Beam Distance**† - 0-300 feet  
**Input** - 120V ± 10% 60Hz  
**Power Consumption** - 5VA  
**Response Time** - .01 sec. for circuit .03 including relay.  
**Output-Relay**: 1 Normally - Open Contact Rated 10A, 120 VAC resistive  
**Lamp** - GaAlAs infrared LED, Life-indefinitely long  
**Sensor** - Silicon phototransistor

**Ambient Operating Temperature Range** -40°F to +131°F (-40°C to +55°C)  
**Ambient Light Tolerance** - 10,000 foot candles  
**Enclosure** - Die cast aluminum powder-coated inside and outside. NEMA 1, 3, 4, 5, 12, 13  
**Shipping weight** - 7 lbs./set  
 †Maximum ranges apply for clean indoor conditions only.

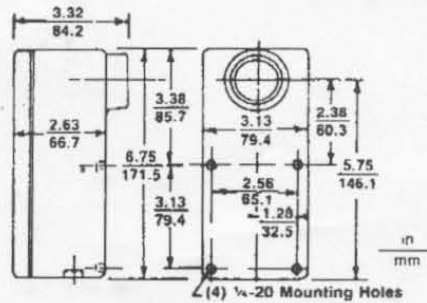

**ELWOOD CORP.-AUTOTRON GROUP**  
 195 W. RYAN ROAD • OAK CREEK, WI 53154-4401 • 414-764-7500  
 TOLL FREE 800-637-2648 • FAX 414-764-4298

76  
0

## **GE Transportation & Global Signals**

### Car Clearance Detection System (CCD-1)

The CCD-1 is a multi-function, single-beam detection system. When the high intensity light beam, detected by a light sensitive photo transistor in the receiver, is interrupted by an object, a relay in the receiver will de-energize, indicating an alarm. This one system, consisting of a light source and photoelectronic receiver, will do all the jobs required of a car-clearance detection system.

### Features

- Four different modes of operation, all on one receiver module: detect, count, walk-thru, gated
- Thermostatically controlled heating of receiver barrel prevents lens fogging
- Existing Erico-type housings can be easily retrofitted with this system
- Both light source and photoelectronic receiver housings are made of lightweight aluminum and are weatherproof
- Light source/photoelectronic receiver alignment is easy and accurate
- Both light source and receiver operate on 12 VDC



Figure B.2. Car Clearance Detection System

## **APPENDIX C – SITE VISIT QUESTIONNAIRE**

1. How long has the detection been in place?
2. Are your installations typically bi-directional or uni-directional installations?
3. Did you consider any other alternatives?
4. Do your installations have any operational problems?
5. Do your installations have any maintenance problems?
6. What is the effectiveness of this detection approach?
7. What is the frequency of the false positive alerts?
8. What is the general environment around the device in regards to a high bird area or gusty winds that would cause a lot of debris in the air? (this goes along with the false detection question.)
9. Do you use any mitigation approaches for false positives (such as loop detection)?
10. Do you have any unique traffic laws?
11. Do you have any unique traffic?
12. How long do you expect this system to last (functionally & technologically)?
13. What are the maintenance and operating costs?
14. Do you have any as-builts available?

15. Where is the local power source?
16. What is or has it been determined how far the power source can be from the installation?
17. What type of wiring is required is required and can it be DB or does it have to be in conduit?
18. Average distance from detection device to alternate route?
19. Do you have advance signing to supplement the warning device?
20. Are the detection devices located in a snow belt area? And if it is, how much snow gets accumulated?
21. Can you buy bullet resistance lens for the warning lights?
22. How long of interruption does it take before the signal is activated?
23. What is your overall opinion of the system and is it cost effective?
24. Any general advice?



# APPENDIX D – SITE VISIT DETAILS

## Pennsylvania Department of Transportation (Pittsburgh)

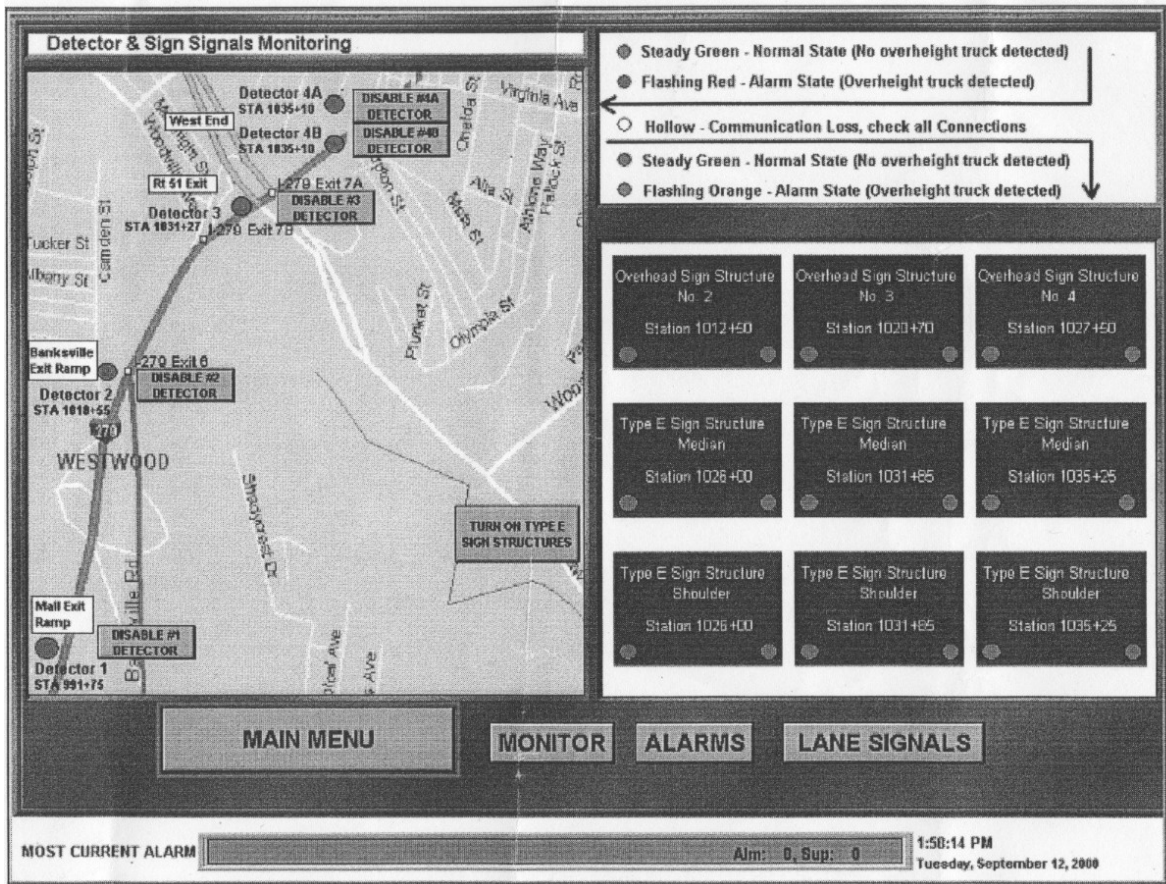

Figure D.1. EWDS Tunnel System (Pittsburgh, PA)

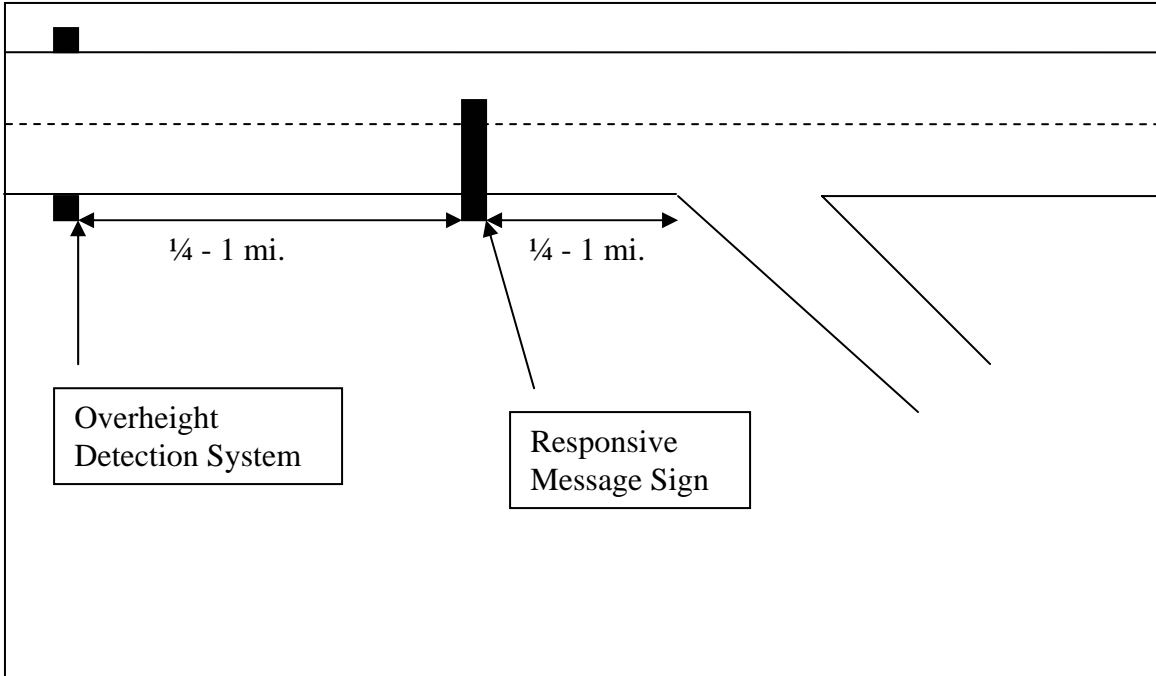

Figure D.2. Isolated EWDS as observed in Pittsburgh

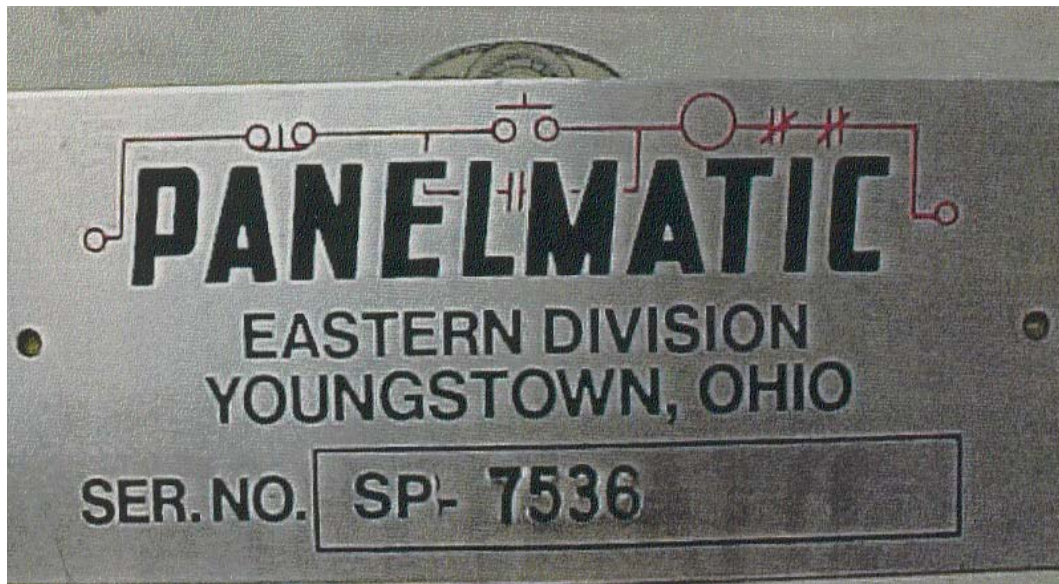

Figure D.3. Responsive Message Sign Manufacturer

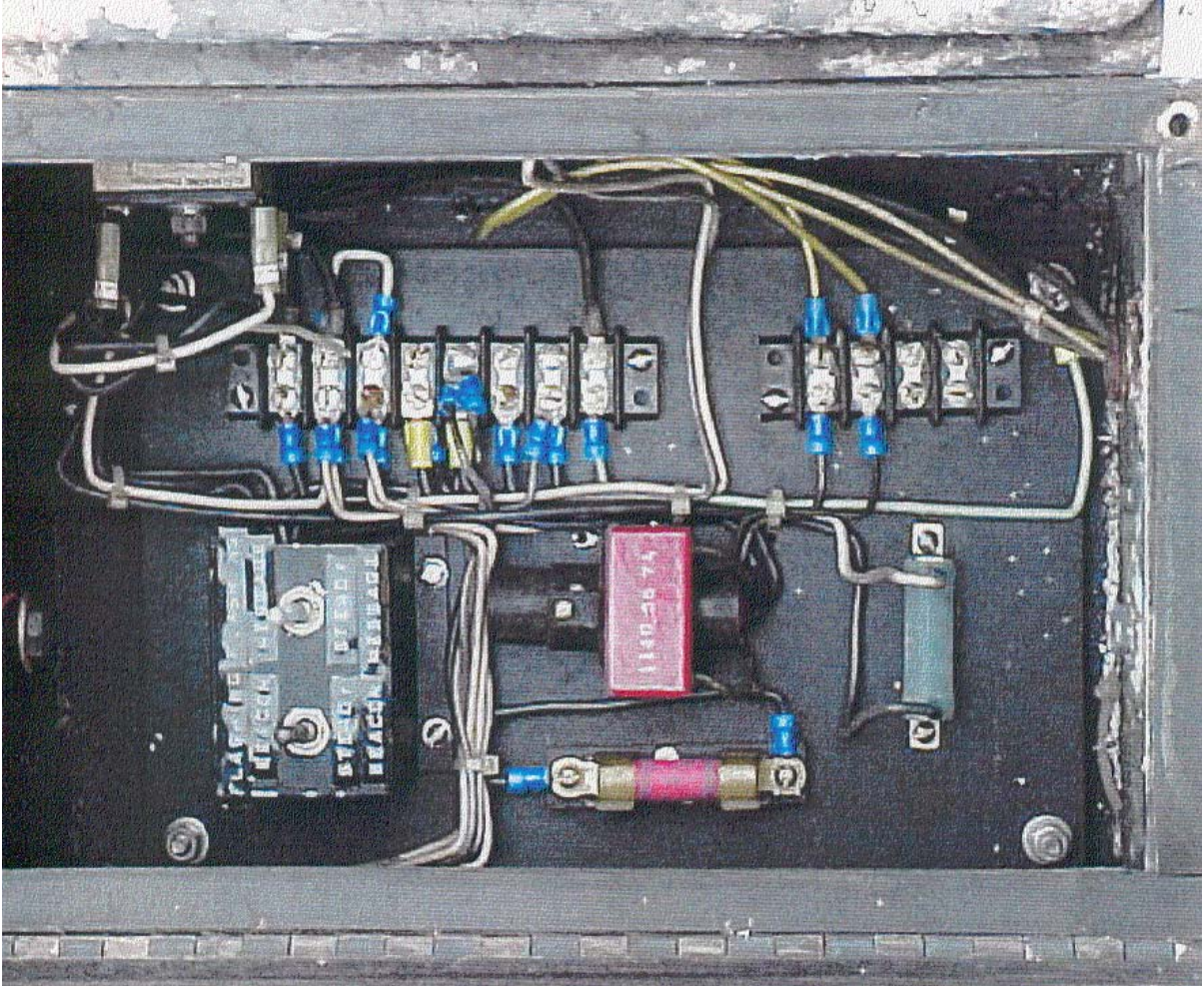

Figure D.4. Responsive Message Sign Wiring

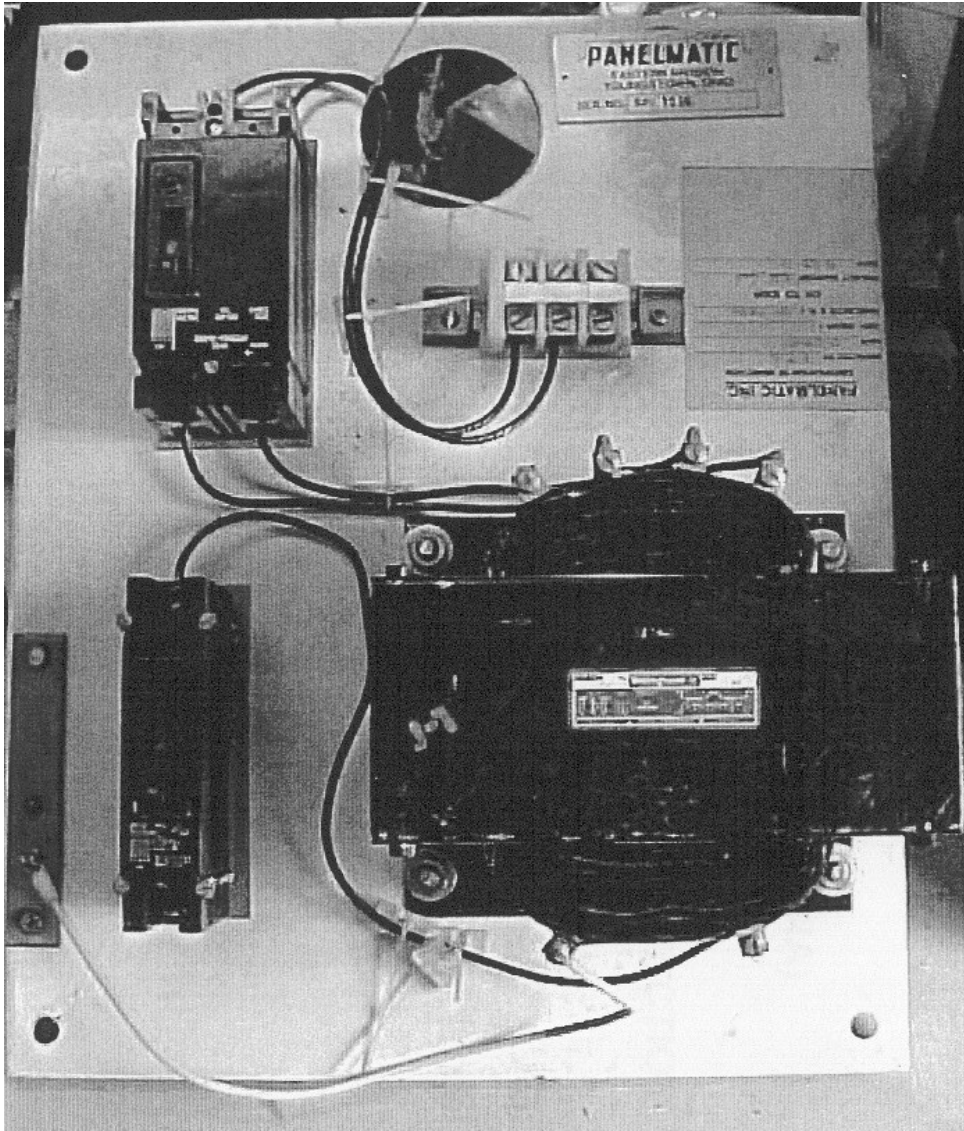

Figure D.5. Responsive Message Sign Circuitry

**California Department of Transportation**

**State of California Commercial Vehicle Enforcement Facilities**

# EXISTING COMMERCIAL VEHICLE ENFORCEMENT FACILITIES

(INSPECTION FACILITIES AND PLATFORM SCALES)

May 2001

CLASS

- (A) Port of Entry Inspection Facility (2)
- (B) Inspection Facility (17)
- (C) Platform Scale with Racetrack (14)
- (D) Platform Scale no Racetrack (20)

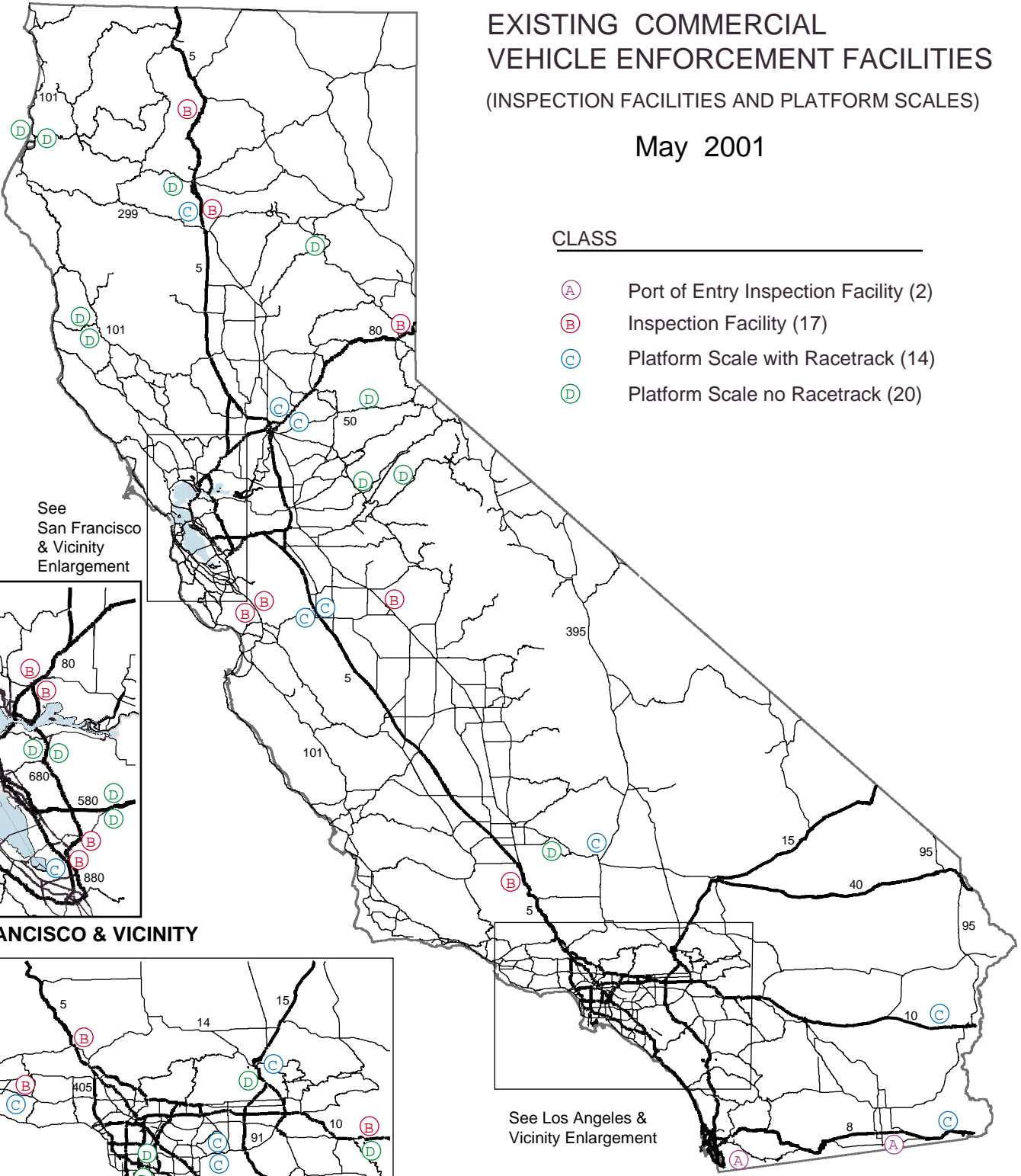

See  
San Francisco  
& Vicinity  
Enlargement

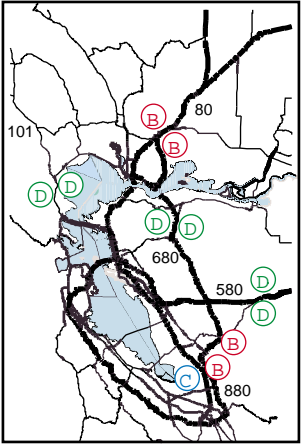

**SAN FRANCISCO & VICINITY**

See Los Angeles &  
Vicinity Enlargement

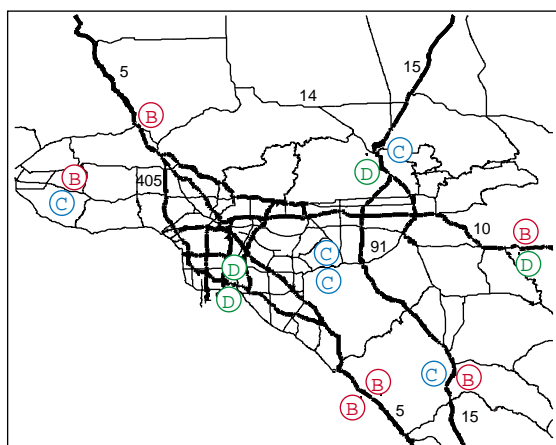

**LOS ANGELES & VICINITY**