

RESOURCE

engineering and technology for a sustainable world

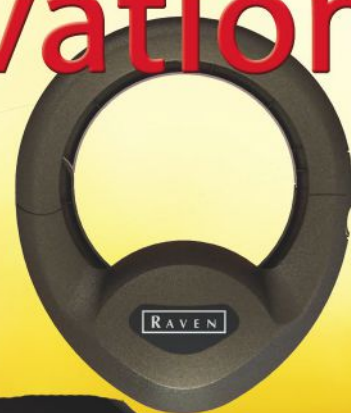

A World of Innovation



Marketing the Value of Ag and Bio Engineering

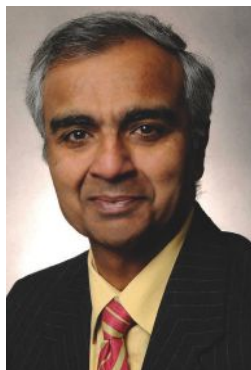

In my first column in the September/October 2013 issue of *Resource*, I asked how well we have marketed our profession. Perhaps it is more appropriate to ask ourselves: should we market our profession? The answer is a resounding yes, if we wish to not only survive but grow, because we are in a relevant, timely, and worthy profession that needs to be better known. For example, it is common

to encounter prominent forums on the grand challenges of climate change, world hunger, sustainability, and the security of food, water, and energy. With our profession's unique interdisciplinary approach, we work in all these areas, yet we are not represented on most of the expert panels seeking solutions to the grand challenges. We are partly to blame for this, because we have not successfully communicated our strengths and abilities.

Now ASABE is addressing that oversight. The McKinley Report, Future Thinking, and Path Forward committees of your leadership team have culminated in a reconfiguration effort, with the underlying objective of better communicating who we are and what we do in the ABE profession and in ASABE. This is the beginning of a marketing effort to help us retain a greater proportion of student members and attract others to join us by showing the world how we are working to solve the grand challenges.

The reconfiguration will also make us more nimble. It will give us more flexibility to expand our horizons even further in enhancing sustainable food, water, and energy systems. The new structure will be advanced first on a national level with the expertise of public-relations professionals and then on a global level to give us our rightful seat at the table. Our profession has great value, but it is not as understood and appreciated as it should be. The opportunity is out there, and the time is right. Marketing our profession can't wait any longer, because the world needs what we can do.

Lalit R. Verma
lverma@uark.edu

events calendar

ASABE CONFERENCES AND INTERNATIONAL MEETINGS

To receive more information about ASABE conferences and meetings, call ASABE at (800) 371-2723 or e-mail mtgs@asabe.org.

2014

- Feb. 10-12 **Agricultural Equipment Technology Conference.** Seelbach Hilton, Louisville, Kentucky, USA.
- April 7-11 **Evapotranspiration: Challenges in Measurement and Modeling from Leaf to the Landscape Scale and Beyond.** Raleigh, North Carolina, USA.
- July 13-16 **ASABE Annual International Meeting.** Montreal, Quebec, Canada.

2015

- July 26-29 **ASABE Annual International Meeting.** New Orleans, Louisiana, USA.

2016

- July 17-20 **ASABE Annual International Meeting.** Orlando, Florida, USA.

ASABE ENDORSED EVENTS

2014

- July 12-13 **2014 Applications of Computer Image Analysis and Spectroscopy in Agriculture.** Montreal, Canada.
- July 16-18 **4th International Symposium on Soil Water Measurement, Using Capacitance, Impedance, and Time Domain Transmission.** Macdonald Campus of McGill University, Montreal, Canada.
- Nov. 1-7 **2014 21st Century Watershed Technology Conference and Workshop.** University of Waikato, Hamilton, New Zealand.

Magazine Staff: Donna Hull, Publisher, hull@asabe.org; Sue Mitrovich, Managing Editor, mitro@asabe.org; Glenn Laing, Contributing Editor, laing@asabe.org; Melissa Miller, Professional Opportunities and Production Editor, miller@asabe.org; Sandy Rutter, Professional Listings, rutter@asabe.org; Darrin Drollinger, ASABE Executive Director, drollinger@asabe.org.

Editorial Board: Chair Tony Grift, University of Illinois; Past Chair Brian Steward, Iowa State University; Thomas Brumm, Iowa State University; Victor Duraj, University of California, Davis; Israel Sunday Dunmade, Mount Royal University of Calgary; Rafael Garcia, USDA-ARS; Christopher Henry, University of Arkansas; Shane Williams, Kuhn North America; Chad Yagow, John Deere Harvester Works; Jeong Yeol Yoon, University of Arizona.

Resource: Engineering & Technology for a Sustainable World (ISSN 1076-3333) (USPS 009-560) is published six times per year—January/February, March/April, May/June, July/August, September/October, November/December—by the American Society of Agricultural and Biological Engineers (ASABE), 2950 Niles Road, St. Joseph, MI 49085-9659, USA.

POSTMASTER: Send address changes to *Resource*, 2950 Niles Road, St. Joseph, MI 49085-9659, USA. Periodical postage is paid at St. Joseph, MI, USA, and additional post offices.

SUBSCRIPTIONS: Contact ASABE order department, 269-932-7004.

COPYRIGHT 2014 by American Society of Agricultural and Biological Engineers.

Permission to reprint articles available on request. Reprints can be ordered in large quantities for a fee. Contact Donna Hull, 269-932-7026. Statements in this publication represent individual opinions.

Resource: Engineering & Technology for a Sustainable World and ASABE assume no responsibility for statements and opinions expressed by contributors. Views advanced in the editorials are those of the contributors and do not necessarily represent the official position of ASABE.

ON THE COVER

Background © Youssouf Cader | Dreamstime.com.

Gear image: © Madmaxer | Dreamstime.com

RESOURCE

engineering and technology for a sustainable world

January/February 2014



Congratulations, AE50 Winners

- 4 4 Series Sprayer and Dry Nutrient Applicator**
John Deere
- 4412F Folding Corn Head**
Case IH Agriculture
- 5 4808NGA Seed Applicator**
KSi Conveyors, Inc.
- 7R Series Tractors**
John Deere
- AUTO FILL for JAGUAR 900 Series**
CLAAS of America, Inc.
- BiG Pack 1290 HDP II**
Krone North America, Inc.
- 6 Blue Wireless Advanced Grain Management**
OPlsystems, Inc.
- CEMOS AUTOMATIC Machine Optimization System**
CLAAS of America, Inc.
- Challenger® MT700E Series Tractors**
AGCO Corporation
- Discbine® Center-Pivot Disc Mower-Conditioners**
New Holland Agriculture
- 7 DISCO 3200 Front Mower**
CLAAS of America, Inc.
- Draper Drive Roller with Tungsten Carbide Ribs**
MacDon Industries, Ltd., and Kondex Corporation
- ECOBlue™ HI-eSCR Exhaust Gas After-Treatment System**
New Holland Agriculture
- Electronic Liquid Blockage Monitor**
CDS-John Blue Company
- 8 Gleaner S88 Class 8 Transverse Rotary Combine**
AGCO Corporation
- Grain-Handling Improvements for Axial-Flow® 230 Series Combines**
Case IH Agriculture
- H380, H360, H340 Ag Loaders with RTP and ESL**
John Deere
- HORIZON® Whole-House Controller**
Valco Companies, Inc.
- 9 Hybrid Mode™ Crop Sensing System**
NORAC Systems International, Inc.
- iCan iGreen System**
Krone North America, Inc.
- Lazer Z X-Series Zero-Turn Riding Mowers**
Exmark Manufacturing Company, Inc.
- MDD-100 Row-Independent Corn Head**
Carlos Mainero y Cia. S.A.I.C.F.I.
- 10 Modular Accelerator for JAGUAR 800 Series**
CLAAS of America, Inc.
- Moisture Tracker™ for Animal Feeds**
Digi-Star® LLC
- MyJohnDeere Operations Center with Location History**
John Deere
- OmniRow® Multi-Hybrid Planter Control System**
Raven Industries, Inc.
- 11 Opti-Speed™ Variable Straw-Walker Speed Technology for CX Combines**
New Holland Agriculture
- RG700 Self-Propelled Sprayer**
AGCO Corporation
- Roll-Belt™ 560 Round Baler**
New Holland Agriculture
- 12 SafeGuard Liquid Blockage Monitor**
Micro-Trak Systems, Inc.
- SimpleSteer Tablet-Based Auto-Steering Solution**
Novariant, Inc.
- SmartCut Cutterbar**
Krone North America, Inc.
- SmarTrax™ MD Assisted Steering System**
Raven Industries, Inc.
- 13 SmartTrax™ System with Terraglide™ Suspension for CR Combines**
New Holland Agriculture
- SoilPro™ 100 Soil Moisture Monitor**
Valley® Irrigation
- Speedrower® Self-Propelled Windrowers**
New Holland Agriculture
- Spliceless™ Baler Belt**
AG Belt™
- 14 Steiger® ROWTRAC™ Tractor**
Case IH Agriculture
- TerraGator® TG9300B Self-Propelled Floater**
AGCO Corporation
- The Pivot Fence**
High Plains Solutions, LLC
- TWIG™ Wireless Valve Control System**
Nelson Irrigation Corporation
- 15 UHarvest Data Management Solution**
Unverferth Mfg. Co., Inc., in partnership with Raven Industries, Inc.
- VersaDeck™ Multi-Use Platform**
Laforge Systems, Inc.
- Viper 4 Field Computer**
Raven Industries, Inc.
- W235 Self-Propelled Windrower**
John Deere
- 16 Index of Winners by Company**

FEATURES

- 17 New Hydraulic Technology for Efficient Machine Steering**
Naseem Daher and Monika Ivantysynova
- 20 Smartphone-Based Lab-on-a-Chip Sensor for Flu Detection**
Jeong-Yeol Toon

UPDATE

- 23 The chicken that isn't: Soy chicken hits commercial market**
- 24 That certain glow: Delayed fluorescence helps monitor health of plants**

- 24 Alternative natural and synthetic rubber for Ohio and the United States**
- 26 Crafting a better enzyme cocktail to turn plants into fuel faster**
- 27 Mystery solved: How some plant species evolved super-efficient photosynthesis and what steps led to that change**
- 28 Spinning CDs to clean sewage water**
- 29 Great Plains producers could profit from spring canola crops**

DEPARTMENTS

- 2 President's Message**
- Events Calendar**
- 29 Professional Opportunities**
- 30 Professional Listings**
- 31 Last Word:**
The Shape of Things to Come
Leon Schumacher

CORRECTION: In the November/December 2013 print issue of *Resource*, Lav Khot's name was misspelled on pages 2 and 18. We regret the error.



American Society of Agricultural and Biological Engineers
2950 Niles Road
St. Joseph, MI 49085-9659, USA
269.429.0300, fax 269.429.3852
hq@asabe.org, www.asabe.org





A Salute to the Winners

Resource is pleased to sponsor the AE50 Awards program—celebrating companies for

their developments in agricultural, food, and biological systems. From the many entries submitted each year, an expert panel selects up to 50 products for recognition. The award-winning products are those ranked highest in innovation, significant engineering advancement, and impact on the market served.

The products featured represent the diversity of agricultural and biological engineering as well as the variety of

companies—of all sizes and specializations—that continue to bring advanced technology and exciting innovations to the marketplace. This year's AE50 recipients join the ranks of many who, for nearly three decades, have been honored for ingenuity in product development—saving producers time, costs, and labor, while improving user safety as well.

The interest in new technology and innovative applications of existing technology remains constant. Many of the products featured are patented and their names trademarked. Some will become widely known. Others may be further improved as technology advances, and perhaps, with time, will win another AE50. But all the winning entrants strived for excellence, and we are pleased to applaud their work with the highest honor in the only awards program of its kind.

Congratulations!



4 SERIES SPRAYER AND DRY NUTRIENT APPLICATOR

John Deere
Moline, Ill., USA
www.johndeere.com

The John Deere 4 Series self-propelled sprayer/spreader is a redesign of the mid-size models of the John Deere sprayer line. The 4 Series sprayers provide customer value by increasing productivity and uptime with features like faster spray speeds, improved weight distribution, larger booms, faster tank fill times, and reduced daily maintenance—all while reducing the overall cost of operation. The R4030 model replaces the 4730 sprayer, and the R4038 model replaces the 4830 sprayer. Features include an optional 120 ft (36 m) boom, which provides 20% greater spraying width when compared to the 100 ft. (30 m) boom on the previous model. The spray solution delivery system also has efficiency improvements, which provide as much as 66% higher flow output and up to 25% faster loading with an on-board solution pump. Machine versatility is enhanced by the optional dry spinner spreader. Field and road transport speeds are improved by as much as 25% and 17%, respectively. A larger, quieter cab with control ergonomics heightens operator comfort.



4412F FOLDING CORN HEAD

Case IH Agriculture
Racine, Wisc., USA
www.caseih.com

The 4412F folding corn head joins the stable of combine headers for Case IH Axial-Flow® combines. This 12-row folding header with 30 in. (76 cm) spacing includes a grain-saving hood with CornLouvers™, which direct the grain back toward the auger to reduce loss, and a simplified folding system for faster transition between harvesting and road modes without having to leave the cab. Additional features to improve productivity are improved row units with increased capacity, a reconfigured gathering chain and divider interface to improve performance in downed corn, replaceable wear strips that protect the plastic hoods and dividers for reduced long-term operating costs, easy-raise dividers and hoods to improve service access, and optional spiral end augers that reduce ear loss in downed corn. The 4412F is available in chopping or non-chopping configurations to meet the needs of every harvester.



4808NGA SEED APPLICATOR

KSi Conveyors, Inc.
Cissna Park, Ill., USA
www.ksiconveyors.com

Patent-pending 4808NGA seed applicator features numerous technological advances in chemical delivery, application efficiency and accuracy, as well as significantly improved installation and cleanout benefits. A seed flow distribution device manages a wide range of incoming seed flow rates and distributes the flow into a uniform “seed curtain” at the point of chemical application. The internal applicator head atomizes and applies a radial chemical stream onto the external seed curtain, thus coating the seed evenly and allowing the drum to advance the conditioning process forward. An 8 ft long x 4 ft (2.4 x 1.2 m) diameter three-section drum mixes and conditions the treated seed and uses engineered placement of mixing paddles and distribution baffles to control the flow of seed for maximum plantability. The discharge process dynamically lifts the conditioned and polished seed out of the drum for quick and complete clean out from the drum’s low-profile configuration.



7R SERIES TRACTORS

John Deere
Moline, Ill., USA
www.johndeere.com

The new 7R Series tractors offer increased power with improved productivity and improved fluid economy. The new e23™ PowerShift transmission with Efficiency Manager offers wide gear selection, which enables automation capabilities with the benefits of smooth shifting and simple operation. The new PowerTech™ PSS 6.8 L and 9.0 L engines embrace Final Tier IV requirements while providing improved fluid economy and uncompromised performance, with a new five-model lineup of 210 to 290 engine horsepower offered worldwide. The new Command View III cab offers improved sound levels, comfort, and functionality. With 40° of right-hand seat swivel, a new CommandARM™ featuring the new 10 in. (25 cm) CommandCenter™ display, laminated front glass, and an optional actively cooled refrigerator, the operator will experience less fatigue and greater performance. Other improvements include LED lights, which give 40% more coverage with 45% less current, and a new cooling system that leads to improved fluid economy, lower sound levels, and improved performance in harsh conditions.



AUTO FILL FOR JAGUAR 900 SERIES

CLAAS of America, Inc.
Omaha, Neb., USA
www.claas.com

AUTO FILL is a system that operates automatically to fill trucks with JAGUAR 900 Series forage harvesters. Operating a forage harvester requires much concentration from the driver throughout the day—navigating the machine, observing the crop flow, checking the machine settings, and giving advice to the truck driver—all while adjusting the discharge spout to fill the wagon properly.

Maintaining this level of concentration creates stress for the driver. Based on 3D image analysis, the AUTO FILL system recognizes the boundaries of the forage box and the fill value of every point within the vehicle next to the harvester. With this input, the AUTO FILL system can automatically adjust the spout without requiring action from the operator. This enables the operator to fill the truck evenly and properly, and it gives the operator more time to focus on crop flow and safe driving in the field.



BiG Pack 1290 HDP II

Krone North America, Inc.
Memphis, Tenn., USA
www.krone-na.com

The BiG Pack 1290 HDP II is a unique large square baler that offers fast baling speeds and dense bales. A new Active Pickup was designed to feed the Variable Filling System at field speeds up to 20 mph (21 kph). The newly designed Variable Filling System, with a 39% increase in capacity over previous models, has been designed with three lifters and one stuffer tine. A new slim-design double knotter system was created for the HDP II and is equipped with eight double knotters to provide additional holding strength for the increased bale density. A benchmark in the large square baler industry, the Krone BiG Pack 1290 HDP II has several standard features as well, including integrated bale scales and a steerable 16-ton axle as well as optional features like bale moisture sensors and more.



BLUE WIRELESS ADVANCED GRAIN MANAGEMENT

OPIsystems, Inc.
Calgary, Alberta, Canada
<http://wirelessgrain.com>

OPI-Blue Wireless Advanced Grain Management is an innovative way of measuring and controlling the environment inside a grain bin. The product uses OPI-Integris temperature and moisture cables but relays information from the cable products via wireless technology, right from the cable head. The wireless cable node can read up

to eight temperature or moisture cables and relay that information on an hourly basis to a wireless gateway device. The node contains a long-life rechargeable and replaceable battery with an integrated cylindrical solar panel for operation even through cold, dark winter months. The gateway is continuously powered and connects to a custom iPad application directly via wi-fi or through an internet connection, including cellular. The app includes 3D visualization of temperature and moisture in tabular and historical line graphs. Due to the modularity and scalability of the system, the user can set up an entire job from off-the-shelf components without custom site engineering.



CEMOS AUTOMATIC MACHINE OPTIMIZATION SYSTEM

CLAAS of America, Inc.
Omaha, Neb., USA
www.claas.com

CEMOS AUTOMATIC is an automatic machine optimization system designed to maximize LEXION combine efficiency using intelligent onboard sensors. It continuously monitors and adjusts the combine's separation and cleaning systems by optimizing each system's settings for real-time conditions during harvest. As a result, the combine is able to automatically deliver maximum throughput while maximizing grain retention and minimizing fuel consumption. All the operator has to do is activate the automatic functions using the multifunction control lever, and CEMOS AUTOMATIC will adjust the following settings: rotor speed (residual grain separation), rotor flap position (residual grain separation), fan speed (cleaning system), upper sieve opening (cleaning system), and lower sieve opening (cleaning system). The operator has a choice of four combine optimization strategies: maximum throughput, minimal fuel consumption, high grain quality, and optimum balance. By selecting one of these strategies, the operator specifies the result that CEMOS AUTOMATIC will attain.

CHALLENGER® MT700E SERIES TRACTORS

AGCO Corporation
Duluth, Ga., USA
www.agcocorp.com

AGCO expands its track tractor offerings with the Challenger® MT700E Series track tractors designed to meet the demanding, high-productivity needs of today's progressive growers. By combining the AGCO POWER™ diesel engine,



Mobil-trac™ undercarriage system, increased hydraulic capacity, and rugged drawbar and three-point hitch, the MT700E Series delivers greater performance. Topped with a Pinnacle View cab, the new tractors put operators in the best position for longer, more productive workdays. Specifically designed for agricultural applications, the 9.8 L, seven-cylinder diesel engine brings on power with a long torque curve and high torque rise at low engine speeds. By eliminating the need to downshift, operators work more efficiently with less fuel consumption.

DISCBINE® CENTER-PIVOT DISC MOWER-CONDITIONERS

New Holland Agriculture
New Holland, Penn., USA
<http://agriculture.newholland.com>

Discbine® center-pivot disc mower-conditioners introduce a high ratio of cut width to conditioning width. WideDry™ conditioners provide a full 125 in. (318 cm) conditioning system with a choice of rubber or steel intermeshing rolls or LeaningEdge™ flails. A wider conditioner allows a thinner mat of crop without higher density at each end, where the crop must be converged from the cutterbar to be within the width of the conditioner. The result is more uniform conditioning and faster drydown. The WideDry™ system also allows delivery of a 10 ft (3 m) wide swath. A kit specifically for biomass harvesting allows the unit to easily harvest biomass crops such as Miscanthus and switchgrass at a desired stubble height of 5 to 8 in. (13 to 20 cm). Extra-high stubble skid shoes are included. Using high-skid shoes without other modifications to the unit decreases the effective range of the header flotation system. Therefore, the kit includes patent-pending mid-height lift-cylinder stops, which hold the trail frame of the unit higher to maintain up-float range.





DISCO 3200 FRONT MOWER

CLAAS of America, Inc.
Omaha, Neb., USA
www.claas.com

The DISCO 3200 is a 9.8 ft (3 m) wide front mower unit that features the CLAAS P-CUT mowing cutterbar, ACTIVE FLOAT hydropneumatic suspension, PROFIL three-dimensional ground-contour tracking, and V-shaped tine or roller conditioners. The P-CUT mowing bars save on fuel consumption by reducing the PTO shaft speed to 850 rpm with no impairment of mowing quality. The ACTIVE FLOAT hydropneumatic suspension system transfers the weight of the mower unit from the ground to the tractor. This effectively converts the frictional resistance encountered during the mowing process into rolling resistance. The PROFIL linkage geometry enables 3D ground contour tracking independent of the movement of the tractor. With a near-to-ground pivot point for lengthwise adjustment, the mower bar follows the ground contour effortlessly. The combination of these features on the DISCO 3200 results in an appreciable decrease in fuel consumption and increase in forage quality and driving comfort.



DRAPER DRIVE ROLLER WITH TUNGSTEN CARBIDE RIBS

MacDon Industries, Ltd., and Kondex Corporation
Winnipeg, Manitoba, Canada, and Lomira, Wisc., USA
www.macdon.com and www.kondex.com

This innovation in drive roller technology comes out of a collaborative effort by the original equipment manufacturer, MacDon Industries, Ltd., and OEM supplier, Kondex Corporation. It consists of a series of ribs built up on the roller to act as an effective traction mechanism, and it is extremely wear resistant. Typical standard drive rollers are constructed of metal tubing with rubber vulcanized to the surface. This design has some disadvantages: when the rubber becomes wet and



sometimes oily (from canola), the drive rollers may lose traction, which results in draper slippage. This new design is constructed of a metal tube, and the traction mechanism is a laser-clad series of ribs affixed to the tube surface. The laser-clad rib material consists of tungsten carbide particles embedded in the matrix, which adheres to the metal tube with a metallurgical bond. These drive roller ribs have a higher degree of traction potential and are extremely wear resistant in all conditions.

ECOBLEU™ HI-eSCR EXHAUST GAS AFTER-TREATMENT SYSTEM

New Holland Agriculture
New Holland, Penn., USA
<http://agriculture.newholland.com>

The ECOBlue™ HI-eSCR exhaust gas after-treatment system ensures that the high-horsepower New Holland T7, T8, and T9 tractors are Tier 4B-compliant while maintaining their outstanding efficiency and productivity. The ECOBlue™ HI-eSCR system is an evolution of the existing ECOBlue™ SCR system and is protected by eight patents. This system has the highest NOx conversion efficiency in the industry—above 95%—while maintaining or improving the productivity of the machine. The new engine control unit manages both the engine and the HI-eSCR after-treatment system by predicting the DEF/AdBlue injection rate for the dosing module. A dedicated closed-loop system continuously monitors NOx levels in the exhaust gases, ensuring that the precise amount of DEF/AdBlue is injected during every cycle. The result is a high NOx conversion rate while guaranteeing low fluid consumption.

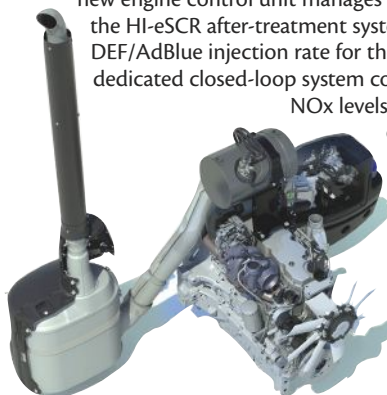

ELECTRONIC LIQUID BLOCKAGE MONITOR

CDS-John Blue Company
Huntsville, Ala., USA
www.cds-johnblue.com

The Electronic Liquid Blockage Monitor is an automatic warning system that alerts an operator when the ball (and therefore flow) in a row of a Visagage II flow monitor has dropped below the user-selected level. When a low-ball position has been detected, visual and audible alarms alert the user. Each row with a low ball is highlighted



by an LED located in the sensor assembly for locating and troubleshooting the blockage. The system uses a sensor assembly mounted behind the Visagage II flow monitor to track where the magnetic balls are floating in each row during liquid application. The Premium system has one sensor assembly with a wireless radio that communicates with an iPad in the cab using the manufacturer's free app, while the Standard system uses a wired control panel. Both systems allow the user to select the level at which the alarm will sound and can be paused to capture troublesome rows for identification later.



GLEANER S88 CLASS 8 TRANSVERSE ROTARY COMBINE

AGCO Corporation
Duluth, Ga., USA
www.gleanercombines.com

Farmers have come to accept increased weight and complexity, and the accompanying challenges, as a requirement for increased capacity. At 32,200 lbs (14,600 kg), the Gleaner S88 transverse rotary combine is the industry's lightest Class 8 platform. With a fully welded mainframe, the Gleaner S88 is also the first Class 8 combine with a transverse rotor design. Rated at 430 hp, the 9.8 L twin-turbocharged seven-cylinder engine with SCR and cEGR delivers greater sustainable horsepower and torque with the lowest fuel and DEF consumption of any Class 8 combine. The Gleaner S88 needs 32 hp less than competitive machines to move through the field, and it substantially reduces compaction, which can affect yield. Despite its smaller size, the Gleaner S88 has more threshing and separating area than other combines. It unloads faster, and it delivers Class 8 grain capacity.



GRAIN HANDLING IMPROVEMENTS FOR AXIAL-FLOW® 230 SERIES COMBINES

Case IH Agriculture
Racine, Wisc., USA
www.caseih.com

Case IH has modified the grain handling systems of Axial-Flow® 230 Series combines to give producers and custom harvesters up to an 8% gain in overall cleaning system productivity, depending on local crop conditions, when harvesting corn. Case IH engineers modified three grain cleaning and handling subsystems to improve grain flow while adding minimally, if at all, to the size, weight, or cost of the combine. Ducts that narrow the stream coming from the fan outlet increase airflow to the pre-sieve and improve air cross-distribution for better chaff separation and grain flow. A steeper angle of the clean-grain sheet moves more grain in high-yielding and high-volume crop conditions. The clean-grain cross auger has been revised to have a larger diameter near the clean-grain elevator inlet for increased grain transport capacity, and the inlet to the clean-grain elevator has a new, larger design to let more grain through in less time.



H380, H360, H340 LOADERS WITH RTP AND ESL

John Deere
Moline, Ill., USA
www.johndeere.com

The Return-to-Position (RTP) option for 6R tractors and H340, H360, and H380 loaders provides superior productivity and repeatability during material handling operations. RTP allows the operator to store two boom positions and two bucket positions through the use of sensors, the tractor's CommandCenter™, and a controller. With simple activation of the momentary detents on the electronic joystick, the loader will return to the preset positions. A complete loading cycle can then be accomplished with four detent clicks of the joystick, significantly improving productivity. Operator stress is reduced as the joystick can be kept in neutral during the automated motion, and there is no need to constantly check the loader height and attachment angle during the operation. The RTP option incorporates the Electronic Self-Leveling (ESL) feature, which provides self-leveling capability without the use of mechanical linkages or complex hydraulics.



HORIZON® WHOLE-HOUSE CONTROLLER

Valco Companies, Inc.
New Holland, Penn.,
USA
www.val-co.com

The HORIZON® whole-house controller is an environmental controller that combines a user-friendly interface with advances in logic and information accessibility for poultry producers. The large 15 in. (38 cm) color touch-screen display allows users to easily see barn performance at a glance, while algorithms automatically adjust ventilation in response to bird activity, inside and outside conditions, and user preferences. HORIZON® combines a large, simple graphical interface with intuitive touch-based navigation to minimize the learning curve for users. Easy remote connectivity allows users to see and influence production conditions from office, home, or smartphone, and data on any flock can be exported for further analysis through the built-in USB port. Users can use the built-in recommendations and configurable software to fine-tune the ventilation to their unique environment and animals, and the controller will automatically provide the best ventilation to minimize costs while maximizing productivity.

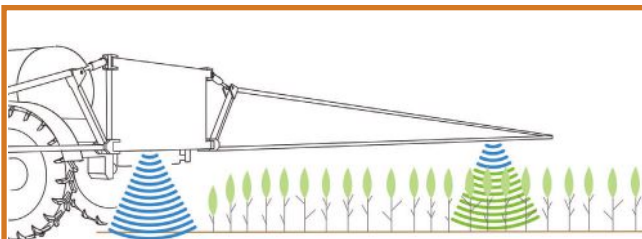

HYBRID MODE™ CROP SENSING SYSTEM

NORAC Systems International, Inc.
 Saskatoon, Saskatchewan, Canada
www.norac.ca

NORAC Hybrid Mode™ is an advanced crop-sensing feature for in-crop spraying with NORAC Spray Height Control systems. Hybrid Mode™ reduces the need for the operator to take manual control of the boom while spraying in row crops or adverse situations such as lodged, thin, and uneven crop. The patent-pending technology in NORAC's ultrasonic height sensors uses the soil and the top of the crop to calculate an average crop height using readings from multiple sensors. A virtual top of crop is generated based on the average crop height and used when the distance to the crop cannot be obtained. Hybrid Mode™ is available on NORAC UCS™ and UC4.5™ Spray Height Control systems.

iCan iGREEN SYSTEM

Krone North America, Inc.
 Memphis, Tenn., USA
www.krone-na.com

The iCan iGreen system controls the internal electronic architecture of Krone BiG X machines. The system comprises innovative electronic systems that were developed in close cooperation with the iGreen Project. The iGreen project is a non-commercial communications platform, an agricultural database that comprises field and GPS data, and a knowledge base that is supplied with information by contractors, farmers, and consultants. The idea is to set up a useful database for the farming world, which grows as ideas are exchanged and information is shared. Using Krone's ISOBUS capabilities, the iCan iGreen system allows information to be collected, recorded, and shared regardless of make and manufacturer. This system also includes many useful options, such as AutoScan, ConstantPower, RockProtect, CropControl, ForageCam, and FieldNav, among others. The iCan iGreen system allows farmers to control their operations and know what is going on with their equipment at all times, allowing all operations to be more productive and efficient.



LAZER Z X-SERIES ZERO-TURN RIDING MOWERS

Exmark Manufacturing Company, Inc.
 Beatrice, Neb., USA
www.exmark.com

Exmark introduces RED on-board intelligence technology on its Lazer Z X-Series riding mowers with Kohler electronic fuel injection (EFI). RED technology uses an electronic governor and operator-defined performance modes to deliver improved engine response and performance combined with reduced fuel consumption of up to 41% compared to equivalent carbureted models. RED includes a clutch-saver feature, and the system monitors vital engine components in real-time to prevent damage if critical thresholds are exceeded. The Lazer Z X-Series is available with a choice of 52, 60, or 72 in. (132, 152, or 183 cm) full-floating UltraCut Series 6 mower decks, and all models include the new, ergonomically advanced Iso-mount seat isolation system. The Lazer Z X-Series with EFI and RED technology sits at the top of Exmark's line of zero-turn riding mowers.



MDD-100 ROW-INDEPENDENT CORN HEAD

Carlos Mainero y Cia.
 S.A.I.C.F.I.
 Bell Ville, Córdoba,
 Argentina
www.mainero.com.ar

The MDD-100 is a 525 mm (21 in.) row-spacing corn head that harvests every row spacing in every direction without adjustment or modification in a wide range of crop conditions—even downed crops—keeping loss levels at a minimum without ground speed restrictions. The side-empty snouts design combined with the double-sprocket gathering chain tensor arm, which provides a V-shaped row unit front end, allows unrestricted and smooth entry of the row unit even when mismatched with the centerline. Working at 525 mm (21 in.) row spacing solves the problem of misaligned rows when the planter width does not match the head width. At narrower row spacings, it allows increase in the working width at the same header weight. It also reduces harvest losses on overlapped headlines, improves performance in downed crops, and harvests in every direction to maximize combine productivity. It allows the operator to plant corn with the same precision planter used for soybeans, and it allows custom harvesters to fit every row spacing with just one header.





MODULAR ACCELERATOR FOR JAGUAR 800 SERIES

CLAAS of America, Inc.
Omaha, Neb., USA
www.claas.com

The Modular Accelerator is designed for simple and quick maintenance work on JAGUAR 800 Series forage harvesters. To minimize loss of harvesting time and money, the market demands



short downtimes for machinery, especially forage harvesters. Unexpected downtime means a full stop of the entire harvesting chain, which includes the trucks used for transportation as well as the machines used for compacting the crop on the pile. The accelerator needs to be replaced when it is worn out or after foreign objects have gone through the machine and caused damage. In the past, replacing the accelerator meant removing either the tower with the spout or the cutting drum. Either way, this process took at least twelve hours. With the new Modular Accelerator concept, the accelerator can be replaced simply, safely, and comfortably in less than one hour.



MOISTURE TRACKER™ FOR ANIMAL FEEDS

Digi-Star® LLC
Fort Atkinson, Wisc., USA
www.digi-star.com

The Moisture Tracker™ is a hand-held, near-infrared (NIR) scanning device that rapidly measures the dry matter and moisture content of animal feeds. The Moisture Tracker™ device provides livestock producers with nearly instantaneous, accurate dry matter and moisture readings, which enable livestock producers to quickly react to changes in dry matter, ensuring that the ration delivered matches the ration calculated. The Moisture Tracker™ provides livestock producers and nutritionists with an affordable on-farm solution to quickly and accurately measure the dry matter and moisture content of both inbound and stored feed. Livestock producers and nutritionists can use the information gathered by the Moisture Tracker™ to provide more consistent rations with the goal of improving productivity, herd health, and profitability.



MYJOHNDEERE OPERATIONS CENTER WITH LOCATION HISTORY

John Deere
Moline, Ill., USA
www.johndeere.com



MyJohnDeere.com is the online portal of the John Deere FarmSight™ strategy. Users can log in to their accounts to access operational and machine data in a centralized location. This includes single sign-on access to

current applications such as JDLINK™ with remote display access, AgLogic™, JDParts, John Deere Financial, StellarSupport™, and the Operations Center. The Operations Center offers a suite of tools to help producers plan, run, and manage their operation through the entire farming cycle, along with products and services that improve machine uptime, logistics management, and agronomic decision-making. Location History from JDLINK™ provides information to boost machine productivity, uptime, and reduce the cost of ownership, including a rolling 24-hour path traveled by machines enabled with JDLINK™ (subscription required), remote monitoring of machine activity, identification of misuse or theft, and access to machine information, such as current machine state, fuel level, heading, and ground speed. Location History is available for sprayers, tractors, combines, self-propelled forage harvesters, and cotton harvesters.



OMNIROW® MULTI-HYBRID PLANTER CONTROL SYSTEM

Raven Industries, Inc.
Sioux Falls, S.D., USA
www.ravenprecision.com

The Raven OmniRow® multi-hybrid planter control system is the first commercially available planter technology capable of dynamically changing the seed hybrid during planting. The system integrates all planter monitoring and control, secondary product control, and tractor guidance functions into a single control platform. The initial market segment targeted is twin-row and inter-plant toolbar configurations. However, the system is designed to support future multi-hybrid meter technology. Another major benefit of this technology is that, with twin-row and inter-plant toolbar configurations, the tractor or implement guidance line is automatically shifted to keep rows straight.



OPTI-SPEED™ VARIABLE STRAW-WALKER SPEED TECHNOLOGY FOR CX COMBINES

New Holland Agriculture
New Holland, Penn., USA
<http://agriculture.newholland.com>

Opti-Speed™ variable straw-walker speed technology for New Holland CX combines represents a harvesting advance that delivers productivity improvements of up to 10% in corn and up to 25% in wheat by automatically matching the straw-walker speed to the crop type and harvesting conditions on flat or hilly ground. The operator selects the crop to be harvested on the in-cab IntelliView™ IV display, and Opti-Speed™ constantly regulates the straw-walker speed for that crop by reading the slope. Going uphill, straw-walker speed is reduced to minimize grain loss from material moving too quickly. On downhill grades, the speed is increased to prevent clogging and inefficient separation. All of this happens automatically, without the operator having to adjust the forward speed of the combine. Opti-Speed™ straw-walker technology is offered as an option on all New Holland CX flagship combines, including models CX7080, CX7090, CX8070, CX8080, and CX8090.



RG700 SELF-PROPELLED SPRAYER

AGCO Corporation
Duluth, Ga., USA
www.applylikeapro.com and www.agcocorp.com

The RG700 is a self-propelled sprayer for use in production agriculture for the application of a wide-range of crop nutrients and crop protection products. With a 700 gal (2650 L) tank, it is designed primarily for the grower market but also provides versatility for use by professional applicators on smaller fields. The RG700 features the AWD (all-wheel drive) Smart Drive System™, even weight distribution, and a parallel C-channel flex frame to provide consistent field speed without shifting and excellent traction with all four wheels remaining in constant contact with the ground. The result is a smoother ride and precise product application, even under varying field conditions. Other features include a powerful, fuel-efficient, high-torque engine to provide consistent power to pull through hills, rough terrain, and soft, wet ground; adjustable track widths to operate quickly and easily through a wide variety of crops, crop heights, and field conditions; and new cab comfort and safety features.



ROLL-BELT™ 560 ROUND BALER

New Holland Agriculture
New Holland, Penn., USA
<http://agriculture.newholland.com>

The Roll-Belt™ 560 round baler lets operators increase their productivity with a new higher-capacity pickup and new features for overall improved ease of use. The entire feeding system, from the pickup reel to the rotary action feeder in the new ActiveSweep™ pickup, improves crop flow for faster core starts and more positive feeding in even the most demanding crop conditions. The new Bale Command™ II Plus control system features easy-to-understand icons and simple menu setups, while an optional ISOBUS system provides expanded information with touch-screen convenience. The updated net-wrap system requires fewer adjustments, and

net rolls are easier to load. The twine-wrapping system uses a dual-twine arm with a center pivot for more consistent twine placement. Both laced and endless belts are stronger and more durable due to new construction methods and designs. Top-hinged side shields open wide for easy access for service and maintenance while introducing a distinctive style.



SAFEWARD LIQUID BLOCKAGE MONITOR

Micro-Trak Systems, Inc.
Eagle Lake, Minn., USA
www.micro-trak.com

SafeGuard is an electronic liquid blockage monitoring system that instantly detects liquid blockages and alerts the operator with an audible alarm and a visual display of the blocked row's number. SafeGuard brings real-time blockage monitoring into the cab. Individual sensors monitor each row and are mounted to suit the needs of the operator as the rows are being monitored, without the need to be seen. Traditional visual ball monitors are difficult to see because they are typically mounted behind the operator, they are hard to see at night or in dusty conditions, and they cannot be seen when using cloudy or dark liquids. The agricultural industry has determined that row blockage monitor systems are a requirement for starter fertilizer applications, and the operator must be able to monitor that there is liquid flow to each row to achieve the top return. SafeGuard provides this instant blockage notification.



SIMPLESTEER TABLET-BASED AUTO-STEERING SOLUTION

Novariant, Inc.
Fremont, Calif., USA
www.novariant.com and www.gpsfarm.com

SimpleSteer is a high-precision auto-steering display solution for precision agriculture that runs on a consumer tablet device. The SimpleSteer software and wi-fi solution from Novariant converts a consumer tablet into a wireless command post for advanced auto-steering operation of tractors, combines, and other farm vehicles. SimpleSteer is compatible with a wide range of tablets based on several operating systems, including Apple's iOS and Google's Android. This makes it possible for farmers to use their own tablets for hands-free steering with high accuracy and repeatability. Novariant offers SimpleSteer as an affordable easy-to-use auto-steer display alternative to complement its current display options. SimpleSteer allow farmers and applicators to choose a display solution that best meets their needs. SimpleSteer is compatible with a full range of auto-steering applications from tillage to planting, crop spraying, and harvesting.

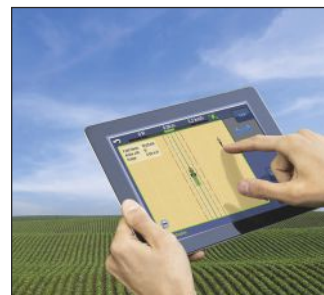

SMARTCUT CUTTERBAR

Krone North America, Inc.
Memphis, Tenn., USA
www.krone-na.com

Every producer is familiar with mowers struggling to produce a clean cut in light crops without streaking. The response to such conditions is Krone's intelligent SmartCut system, which has been proven in initial runs by delivering outstanding results. SmartCut means the discs are strategically, unevenly spaced: the pairs turning outward are set closer together to increase blade overlap for superb cut quality without streaking. In dense crops, the machine benefits from a larger gap between the discs turning toward each other to deliver a constant and smooth flow of crop to the rear without blockage and with cleaner cuts at higher work rates. In addition, all new mowers offer comfort features, including an enclosed and fully welded cutterbar, standard quick-change blades, and the SafeCut system. The new SmartCut cutterbar is used on nearly all new-generation EasyCut mowers.



SMARTRAX™ MD ASSISTED STEERING SYSTEM

Raven Industries, Inc.
Sioux Falls, S.D., USA
www.ravenprecision.com

The patent-pending SmarTrax™ MD mechanical assisted steering system is an easily transferrable system capable of up to RTK-level accuracy with 3D terrain compensation. The system incorporates a simple latch mechanism that allows the operator to easily transfer SmarTrax™ MD between multiple tractors, combines, and windrowers and offers more leveraging of a single investment across the fleet without sacrificing performance. Using advanced motor technology, with added torque for faster operating speed and better line acquisition, the SmarTrax™ MD is a combination of high performance, thoughtful design, and quiet operation.





SMARTTRAX™ SYSTEM WITH TERRAGLIDE™ SUSPENSION FOR CR COMBINES

New Holland Agriculture
New Holland, Penn., USA
<http://agriculture.newholland.com>

The SmartTrax™ system with Terraglide™ suspension for New Holland CR combines is a track system that follows the contour of fields or roads using rollers that adjust side to side as well as up and down for maximum traction, less soil compaction, and greater driver comfort. The triangular structure of SmartTrax™ is designed to reduce ground pressure by up to 60%, when compared to wheeled machines, and to improve stability while maintaining the maneuverability of traction-tired combines. SmartTrax™ features positive lug drive, which ensures that maximum tractive force is transferred to the ground. When traveling on roads, the Terraglide™ suspension system minimizes vibration and improves driver comfort. The SmartTrax™ system with Terraglide™ suspension is available in 24 and 28.5 in. (61 and 72 cm) widths and is an option on all New Holland CR flagship combines, including models CR8080, CR9070, CR9080, CR9090, and CR10090.



SOILPRO™ 100 SOIL MOISTURE MONITOR

Valley Irrigation
Valley, Neb., USA
www.valleyirrigation.com



Valley SoilPro™ 100 is a soil moisture monitor designed for mechanical center pivot control panels. It is an early warning system that alerts growers when soil conditions are either too wet or too dry. SoilPro™ 100 does not require Internet services or subscriptions in order to receive SMS messages about soil conditions. A computerized control panel is also unnecessary. This product addresses the most common issue with mechanized irrigation: over-watering. Most growers can use this basic, low-cost option to receive soil condition notifications, which can be customized to the specific needs of a market group. Valley SoilPro™ 100 also can benefit growers using drip or flood irrigation by providing a simple, low-cost option for monitoring soil conditions. Without complex graphs and charts, SoilPro™ 100 simply sends growers an SMS message notifying them of a condition that needs attention.

SPEEDROWER® SELF-PROPELLED WINDROWERS

New Holland Agriculture
New Holland, Penn., USA
<http://agriculture.newholland.com>

A high-speed transport option, improved hydro-mechanical steering, and integrated IntelliSteer™ auto-guidance make the Speedrower® more productive, getting an operator into the field more quickly and allowing faster field speeds with a full header on every pass. Transport speeds up to 24 mph (38 kph) are beneficial to customers with widespread haying operations and custom operators. IntelliSteer auto-guidance provides the ability to operate within 6 in. (15 cm) of pass-to-pass accuracy at speeds up to 16 mph (25 kph), even with a WAAS guidance signal. An added benefit: guidance information is provided on the existing Intelliview™ IV touch-screen monitor. Precise in-field steering comes with a new hydro-mechanical steering system and through elimination of several mechanical components and tighter machining tolerances on components still used. Incorporation of a steering motor, as used on conventional steering systems, facilitates the addition of integrated auto-guidance. No separate electric motors need be mounted on the steering column.



SPLICELESS™ BALER BELT

AG Belt™
Des Moines, Iowa, USA
www.agbeltinc.com

The AG Belt™ Spliceless™ Baler Belt is the only belt for large round balers that does not have a splice, eliminating the primary cause of failure in baler belts today. The patented design combines technology from multiple industries in innovative ways to create a solution to the most vexing problem with baler belts. Market-leading round baler manufacturers, such as New Holland, are now offering this premium belt as a factory option worldwide. The Spliceless™ baler belt design is more resistant to punctures and tears, and it is stronger than other belts. Its unique construction also offers the ideal combination of longitudinal flexibility and transverse stiffness for optimal belt tracking. The Spliceless™ baler belt is built to outperform and outlast.



STEIGER® ROWTRAC™ TRACTOR

Case IH Agriculture
Racine, Wisc., USA
www.caseih.com

The Case IH Steiger® ROWTRAC™ tractor is a four-track articulated agricultural tractor designed specifically for use in row-crop applications in a wide range of working conditions. It offers less soil compaction and better ride characteristics. The Steiger® ROWTRAC™ is available with three track widths, 16, 18, and 24 in. (41, 46, and 61 cm), three tread settings, 80, 88, and 120 in. (203, 223, and 305 cm), and three engine horsepower ratings (350, 400, and 450 hp) to address many applications. The tractor includes modified frames for improved steering angle, new axles designed to carry increased loads at all tread settings, and new undercarriages and track systems to accommodate narrow tracks and follow the contour of the ground and road. Extensive development resulted in a narrow track-and-roller system with a patented pivoting undercarriage that can carry the same loads as a wide-track machine while delivering more flexibility, efficiency, and productivity.

TERRAGATOR® TG9300B SELF-PROPELLED FLOATER

AGCO Corporation
Duluth, Ga., USA
www.applylikeapro.com and www.agcocorp.com

The TG9300B is AGCO's largest self-propelled three-wheel flotation TerraGator® model. Designed for use in production agriculture for pre-emergence, pre-plant, and post-harvest applications of a wide range of crop inputs in liquid and dry form, the TG9300B includes a combination of engine technologies to meet Tier 4 Final requirements. These technologies include dual turbochargers, cooled exhaust gas recirculation (cEGR), selective catalytic reduction (SCR), and diesel oxidation catalysts (DOC) to clean emissions in the exhaust system without interfering with engine performance. Coupled with a continuously variable transmission (CVT), the TG9300B has the potential to increase productivity while using 5% to 8% less fuel compared to the previous TG9300 model. New system hydraulics provide maximum hydraulic capacity at a lower engine speed, also contributing to fuel savings, along with an 8 dB noise reduction in the cab.



THE PIVOT FENCE

High Plains Solutions, LLC
Litchfield, Neb., USA
<http://thepivotfence.com>

The Pivot Fence is a commercial, portable fencing device that attaches to any irrigation center-pivot and turns it into a mechanized electric cross fence for livestock grazing systems. This innovation attaches to any make and model of center-pivot or lateral irrigation system—without any alterations to the pivot—to suspend an electrified wire to a desired height, even in the roughest terrain. Using the center-pivot as a moveable cross fence reduces the labor component of grazing livestock from manually moving posts and wire to simply moving the center-pivot with the push of a button. Larger-scale forage-based or crop-residue grazing operations can be achieved with minimal labor. Allowing the livestock to graze forages can reduce production costs and add value back to crop rotations by leaving residue and manure in the field.

TWIG™ WIRELESS VALVE CONTROL SYSTEM

Nelson Irrigation Corporation
Walla Walla, Wash., USA
<http://nelsonirrigation.com>

The TWIG™ is a reliable automation solution for irrigated agriculture. Installation is quick and easy: mount the TWIG™ to a Nelson control valve, and then program the TD200 to create a



schedule for automatic valve sequencing. The simple interface of the TWIG™ and TD200 controller make it easy to automate an entire irrigation system, regardless of the system type or the size of the operation. Whether managing a large Big Gun® dust suppression

system, an apple orchard, multiple zones of a drip system, or miles of sprinklers on row crops, the TWIG™ can tie the components together without the expense of trenching and wires. The controller contains watering schedules that operate each valve. After it automatically discovers all valve modules, the controller is programmed at one location. All valves are synchronized. Program setup consists of simply grouping all valves that irrigate at the same time. Programs are easily named by the user to indicate the purpose of valve arrangements and the function of irrigation schedules.

UHARVEST DATA MANAGEMENT SOLUTION

Unverferth Mfg. Co., Inc.,
in partnership with
Raven Industries, Inc.
Kalida, Ohio, USA
www.unverferth.com



The UHarvest data management system is an ISOBUS-compatible system that can work with existing virtual terminals or tablet devices that provide a touch-screen interface to display and manage grain cart and harvest data. The system includes a Wi-Fi connection point for sharing information with multiple tablets and smart phones within a 400 ft (122 m) range. In addition to the total load weight, the system also displays the hitch weight to allow level loading of the grain cart. For enhanced record keeping, an optional moisture sensor mounted on the grain cart detects grain moisture for automatic conversion of wet to equivalent dry bushels. The level of harvest data management can be further increased by uploading data to a Raven Slingshot account from the field via a tablet on a data plan, which can then be accessed online by owners and managers with an Internet connection.

VERSADECK™ MULTI-USE PLATFORM

Laforge Systems, Inc.
Concord, Calif., USA
www.versadeck.net



VersaDeck™ is a 96 x 72 in. (244 x 183 cm) flat deck multi-use platform with 3300 lbs (1500 kg) of carrying capacity that is designed to be attached to a tractor's three-point hitch, a front-end loader, or a skid-steer loader. The unique design of the back plate provides multiple mounting points for accessories, numerous tie-down points, as well as compatibility with Cat2, Cat3N, Cat3, and Cat4N three-point hitches, Euro and John Deere quick-connect interfaces, and skid-steers—while still providing the necessary strength to support the rated load capability. In addition to flexibility for the user, the design takes into consideration efficiency in marketing and distribution by allowing five complete units to be stacked on a pallet. Several details in the design, supported by extensive stress analysis, enable an optimized manufacturing process. Applications for VersaDeck™ can be extended by the many available options, including gates based on OSHA recommendations, tool and battery boxes, brackets for winches and vises, and more.



VIPER 4 FIELD COMPUTER

Raven Industries, Inc.
Sioux Falls, S.D., USA
www.ravenprecision.com

The rugged, sleek Viper 4 field computer with ROS (Raven Operating Software) provides a modular, flexible application-based approach to efficiently manage farming operations with many customization opportunities. The Viper 4 uses advanced product profiles that incorporate agX reference databases, which provides extraordinary data management. Additional capabilities include automated machine configuration, rapid job start, customizable run-screen design, automated bin chaining, wi-fi, and advanced wireless Slingshot integration assist to provide increased efficiency, productivity, and profitability for farming operations. Viper 4 is fully customizable, including portrait or landscape display orientation in the cab.

W235 SELF-PROPELLED WINDROWER

John Deere
Moline, Ill., USA
www.johndeere.com

The W235 self-propelled windrower features an all-new cab, a new system for maintaining constant header speed, and 235 rated horsepower with 255 maximum horsepower. The all-new cab enables long hours and increased operator



productivity. The new constant header speed system allows up to a 900 rpm drop in loaded engine speed while maintaining the same header speed and functionality. The 22% increase in horsepower delivers power to the head through a newly designed

hydraulic system. The most significant feature of this product is the integrated AutoTrac™, which allows field operating speeds of up to 28 kph while maintaining a line acquisition accuracy of ±10 cm. This product is a major modification of the previous R450 and D450 self-propelled windrower models, a modification driven by emission regulations.



Index of winners by company

AG Belt™

- 13 Spliceless™ Baler Belt

AGCO Corporation

- 6 Challenger® MT700E Series
- 8 Gleaner S88 Class 8 Transverse Rotary Combine
- 11 RG700 Self-Propelled Sprayer
- 14 TerraGator® TG9300B Self-Propelled Floater

Carlos Mainero y Cia. S.A.I.C.F.I.

- 9 MDD-100 Row-Independent Corn Head

Case IH Agriculture

- 4 4412F Folding Corn Head
- 8 Grain-Handling Improvements for Axial-Flow® 230 Series Combines
- 14 Steiger® ROWTRAC™ Tractor

CDS-John Blue Company

- 7 Electronic Liquid Blockage Monitor

CLAAS of America, Inc.

- 5 AUTO FILL for JAGUAR 900 Series
- 6 CEMOS Automatic Machine Optimization System
- 7 DISCO 3200 Front Mower
- 10 Modular Accelerator for CLAAS JAGUAR 800 Series

Digi-Star® LLC

- 10 Moisture Tracker™ for Animal Feeds

Exmark Manufacturing Company, Inc.

- 9 Lazer Z X-Series Zero-Turn Riding Mowers

High Plains Solutions, LLC

- 14 The Pivot Fence

John Deere

- 4 4 Series Sprayer and Dry Nutrient Applicator
- 5 7R Series Tractors
- 8 H380, H360, H340 Ag Loaders with RTP and ESL
- 10 MyJohnDeere Operations Center with Location History
- 15 W235 Self-Propelled Windrower

Krone North America, Inc.

- 5 BiG Pack 1290 HDP II
- 9 iCan iGreen System
- 12 SmartCut Cutterbar

KSi Conveyors, Inc.

- 5 4808NGA Seed Applicator

Laforge Systems, Inc.

- 15 VersaDeck™ Multi-Use Platform

MacDon Industries Ltd and Kondex Corporation

- 7 Draper Drive Roller with Tunston Carbide Ribs

Micro-Trak Systems, Inc.

- 12 SafeGuard Liquid Blockage Monitor

Nelson Irrigation Corporation

- 14 TWIG™ Wireless Valve Control System

New Holland Agriculture

- 6 Discbine® Center-Pivot Disc Mower-Conditioners
- 7 ECOBlue™ HI-eSCR Exhaust Gas After-Treatment System
- 11 Opti-Speed™ Variable Straw-Walker Speed Technology for CX Combines
- 11 Roll-Belt™ 560 Round Baler
- 13 SmartTrax™ System with Terraglide™ Suspension for CR Combines
- 13 Speedrower® Self-Propelled Windrowers

NORAC Systems International Inc.

- 9 Hybrid Mode™ Crop Sensing System

Novariant, Inc.

- 12 SimpleSteer Tablet-Based Auto-Steering Solution

OPIsystems, Inc.

- 6 Blue Wireless Advanced Grain Management

Raven Industries, Inc.

- 10 OmniRow® Multi-Hybrid Planter Control System
- 12 SmarTrax™ MD Assisted Steering System
- 15 Viper 4 Field Computer

Unverferth Mfg. Co., Inc.,

in partnership with Raven Industries, Inc.

- 15 UHarvest Data Management Solution

Valco Companies, Inc.

- 8 HORIZON® Whole-House Controller

Valley- Irrigation

- 13 SoilPro™ 100 Soil Moisture Monitor

Congratulations from the Resource staff

If you have any questions about the AE50 Awards program, visit the ASABE website (www.asabe.org/publications/resource-magazine/ae50-new-product-award.aspx), or contact **Sandy Rutter** (rutter@asabe.org, 269-932-7004).



New Hydraulic Technology for Efficient Machine Steering

Naseem Daher and Monika Ivantysynova

© Perfume316 | Dreamstime.com

Fossil fuel prices are not going back down to their early 2000s levels, period. This fact, along with increased environmental awareness to decrease hydrocarbon emissions, has pressed researchers in all disciplines to increase the energy efficiency of machines and reduce their carbon footprint. This article describes an energy-efficient steering technology that has been implemented on a wheel loader. This new steering system decreased fuel consumption by 15%, increased machine productivity by 23%, and boosted overall fuel efficiency by a whopping 43%. These results are aligned with the goals of the mobile machinery industry, in which reducing fuel consumption and increasing machine productivity are of utmost importance to both original equipment manufacturers (OEMs) and their end customers. The industry has been longing for a breakthrough technology that meets these pressing challenges.

State-of-the-art technologies that power the working hydraulic functions of mobile machines mainly use hydraulic actuation, load-sensing in particular, for motion control. Load-sensing systems are more efficient than their predecessors, but they still result in considerable energy dissipation due to throttling losses across their control valves.

A revolutionary technology that has proven to be an energy-efficient alternative to valve control is now available. This technology, known as pump displacement controlled (DC) actuation, improves energy efficiency by doing away with control valves for high-power motion control and uses instead a variable-displacement pump to regulate the hydraulic flow rate. In the past decade, DC technology has been researched and implemented for the working hydraulic functions of several mobile machines. DC resulted in 15% fuel savings on a wheel loader, 20% fuel savings on a skid-steer loader, and 40% fuel savings on an excavator. These

are such significant results that they cannot go unnoticed any longer. However, for DC actuation to become mainstream, it must be capable of realizing all of the hydraulic functions used on mobile machines.

One of the systems that has not been explored for the implementation of DC technology is the steering system. A DC steering system can be classified as an electro-hydraulic steer-by-wire system. *X*-by-wire systems, where the *X* stands for fly, drive, brake, or steer, are the control systems of the future. This trend started in the aerospace industry, transitioned into the automotive sector, and has been finding its way into earth-moving machines. As such, the steering system described in this article is in harmony with the long-term vision of OEMs, but it is readily available and could be implemented in the near future. By now, you're probably starting to wonder how the new system works.

How does the new DC steer-by-wire system work?

Figure 1 is a schematic of the new DC steer-by-wire system. The actuator (8) velocity is controlled by adjusting the speed, displacement, or both, of an axial-piston variable-displacement pump (2). The pump input and output ports are connected to the piston and rod sides of the actuator. The differential fluid flow between the actuator's uneven sides is

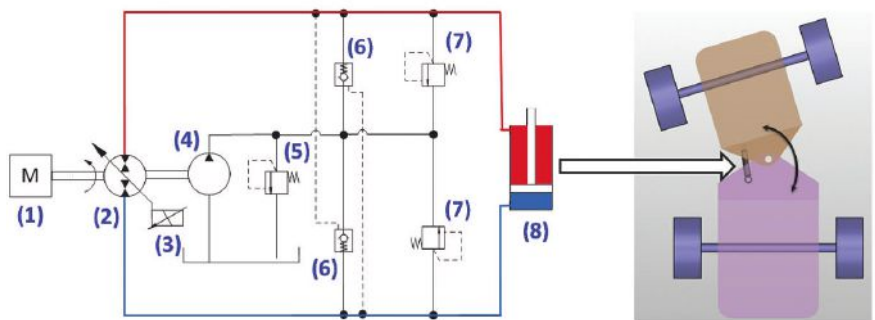

Figure 1. DC steer-by-wire hydraulic schematic.

overcome by means of pilot-operated check valves (6), which keep the low-pressure side of the actuator connected to a low-pressure source that can either provide or absorb flow to prevent evacuation. The low-pressure source has its own fixed displacement charge pump (4) that provides continuous flow to the cylinder's low-pressure side. The low-pressure level setting is adjusted by a pressure-relief valve (5). The system is protected from overpressurization by pressure-relief valves (7) installed on both sides of the actuator. The pump displacement control system (3) uses an electrohydraulic proportional control valve to adjust the swash plate angle of the pump.

Like any X-by-wire system, the DC steering system eliminates the physical connection between the steering wheel and the steering components. Hence, the steering wheel feedback would be lost without the incorporation of a tactile feedback device. Using electronic control, the DC steering system can reduce operator fatigue at low speeds while improving safety at high speed by controlling the level of steering wheel torque that is fed back to the operator. This feedback is regulated based on the steering wheel angle and turning speed, the vehicle speed, and the articulation angle between the two frames. Thus, the system can simulate end-of-rotation stops, limit the steering wheel's rotation speed, and provide variable effort as a function of vehicle speed. Control of the pump displacement (flow rate) and steering wheel torque is executed by an electronic control unit, which receives the sensor signals and commands the pump adjustment system and the torque feedback device to produce the desired performance. Figure 2 shows these electronic signals.

Advantages of the New Technology

The new technology offers improved fuel efficiency, flexibility of steering feel and sensitivity gains at various operating conditions, active safety features (e.g., stability control), improved line holding capability, potential for autonomous machine operation,

and more. In addition to eliminating the hydraulic control valves, the system architecture and control

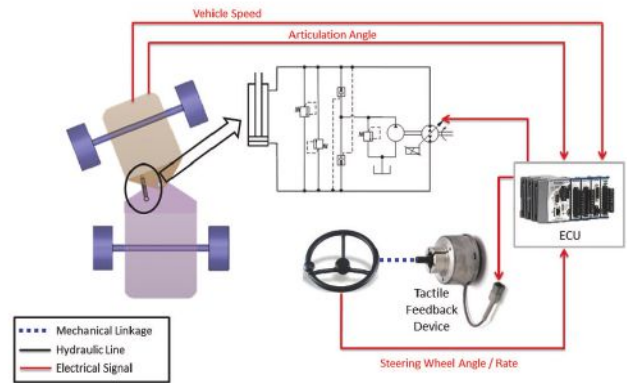

Figure 2. DC steer-by-wire system control.

schemes are simplified with the new technology. Reducing the required cooling power is also possible due to lower heat generation at the fluid level. In some applications, there is a possibility of reducing the engine power, since the new technology lends itself to hybridization by capturing available kinetic and potential energy and storing it for later use.

Implementation of the New Technology

The new system was retrofitted on a compact (five ton) wheel loader at Purdue University's Maha Fluid Power Research Center. Prior to the hardware implementation, comprehensive analysis was performed to properly size the new system and components, develop a high-fidelity dynamic model of the hydraulics and vehicle dynamics, and design appropriate control algorithms that result in optimal steering performance. The stock machine with its load-sensing hydrostatic steering system was tested to establish a benchmark for later evaluation of the new DC steering system. Once the analytical phase and baseline testing were concluded, the stock steering system components were removed and the new DC steering system components were installed, along with the required sensors, signal conditioning modules, data acquisition system, and real-time controller. The two main compo-

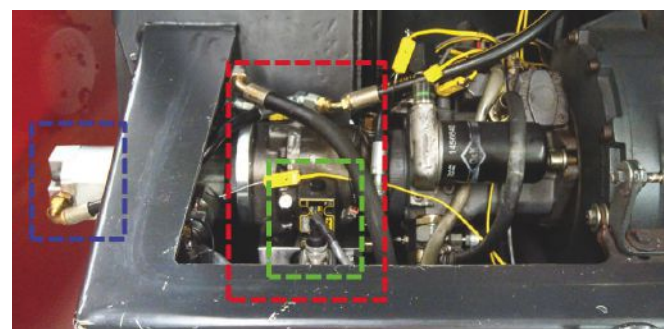
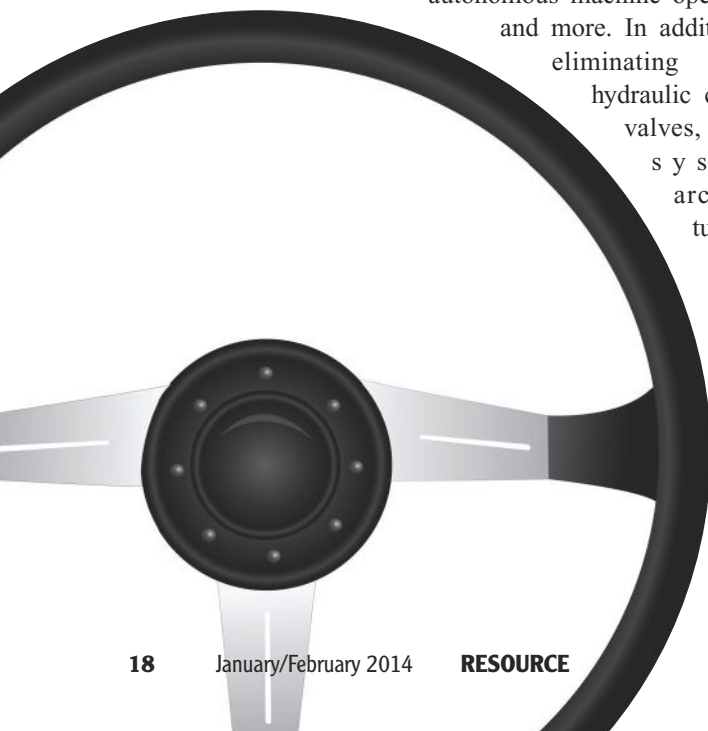

Figure 3. DC steering system hydraulic components: the steering pump is enclosed in the red dashed rectangle, the proportional control valve is enclosed in the green dashed rectangle, and the charge pump is enclosed in the blue dashed rectangle.



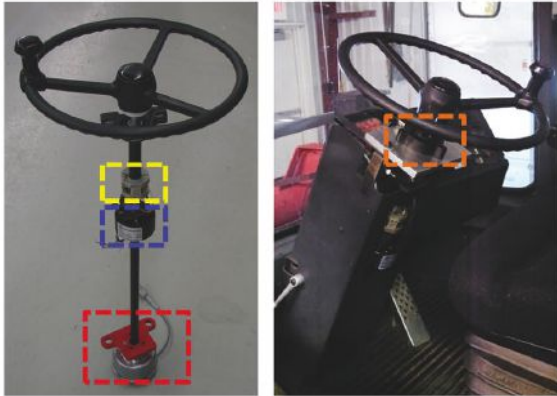
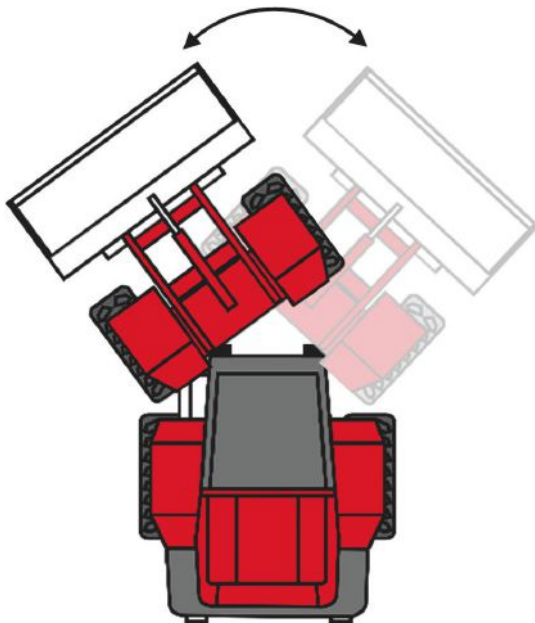

Figure 4. New DC steer-by-wire system steering column assembly: the torque feedback device is enclosed in the red dashed rectangle, the steering wheel torque sensor is enclosed in the yellow dashed rectangle, a slip ring for managing the torque sensor cable is enclosed in the blue dashed rectangle, and the steering wheel angle sensor is enclosed in the orange dashed rectangle.

nents of the new system include the hydraulic components and the steering column assembly. The hydraulic components are shown in figure 3, and the mechanical components of the steering column are shown in figure 4.

Validation of the New Technology

A steering-only maneuver was devised such that only the steering system was active during the cycle. During the test, the machine was fully articulated from left to right while staying



Steering-only test maneuver.

Test results for stock hydrostatic steering and new DC steering.

	Fuel Consumption (kg)	Total Steering Work Done by Machine (MJ)	Steering Work per Fuel Mass (MJ kg ⁻¹)
Stock steering system	0.291	0.639	2.232
New DC steering system	0.249	0.784	3.203
Difference	-14.5%	+22.6%	+43.5%

stationary in the longitudinal direction; hence, the transmission remained in neutral. The boom and bucket functions were maintained at predetermined settings, requiring no hydraulic power supply. The axle loads were established with a fixed bucket load and specified surfaces. The engine throttle was held at its maximum level, and the cycle duration was fixed. The above table summarizes the results attained after performing the steering-only maneuver with the stock hydrostatic steering system and with the DC steer-by-wire system.



Prototype test vehicle with DC steer-by-wire system.

The DC steer-by-wire system delivers considerable fuel savings, increased machine productivity, and improved overall fuel usage efficiency. The new steering system also yields excellent controllability and non-synthetic steering wheel feel that meets or exceeds the conventional feel. Future research will look into using virtual sensors for active safety functions such as stability control, investigate adaptive control algorithms to make the machine adapt to varying operating conditions and uncertain parameters, and bring the technology closer to tele-operation and potentially fully autonomous operation.

Naseem Daher, Ingersoll-Rand Fellow and Doctoral Student, School of Mechanical Engineering, Purdue University, West Lafayette, Ind., USA, ndahe@purdue.edu.

Monika Ivantysynova, Maha Professor of Fluid Power Systems, Director of the Maha Fluid Power Research Center, School of Mechanical Engineering and Department of Agricultural and Biological Engineering, Purdue University, West Lafayette, Ind., USA, mivantys@purdue.edu.

Smartphone-Based Lab-on-a-Chip Sensor for Flu Detection

Jeong-Yeol Yoon

© Perfume316 | Dreamstime.com

Influenza, commonly referred to as flu, is so common that we often forget its danger. However, according to the CDC, it is one of the top ten causes of death in the United States (www.cdc.gov/nchs/fastats/lcod.htm). Flu jumps from one species to another through coughs or sneezes. In the past couple of decades, we have witnessed two major outbreaks of lethal flu variants: bird flu (influenza A/H5N1) and H1N1 flu (influenza A/H1N1). Since their initial symptoms are very similar to those of other seasonal flu variants, early diagnosis is critical.

The current gold standard in flu detection is reverse transcription polymerase chain reaction (RT-PCR) in which a specific sequence of genetic material from flu is copied about a million times. An alternative method, called an immunoassay, takes advantage of antibodies specific to the influenza virus. Both processes require a variety of laboratory equipment and a series of pipetting and liquid handling operations, all of which take several hours. They are preferably performed in a laboratory setting, which involves an additional time lag.

Lab-on-a-chip (LOC) detects flu

For early diagnosis of influenza, it is desirable to conduct RT-PCR or an immunoassay at the point-of-care level, or even in the field. The lab-on-a-chip (LOC) is the perfect instrument for this. An LOC is essentially a network of channels and wells that is etched onto a silicon or polymer substrate in order to build a miniature laboratory. The LOC enables sample handing, mixing, dilution, separation, staining, and detection within a single, integrated system and is perfectly suitable for chemical or biological assays.

Both RT-PCR and immunoassays, including flu detection, have been demonstrated in LOCs. Final detections in an LOC can be made electrochemically or optically, but optical detection is gaining popularity due to its high sensitivity and better specificity. Back in the old days, the optical detection system incorporated into an LOC was often much bigger than the LOC itself, and it required a separate laptop computer to process and analyze the signals. These days, optical detection in an LOC can be implemented through the use of an LED light source, a pair of optical fibers, and a miniature spectrometer.

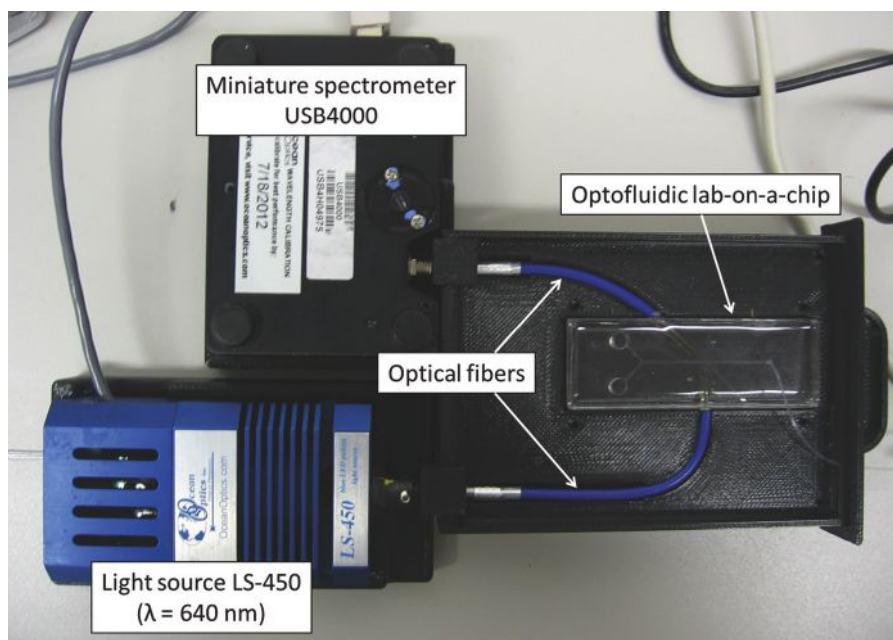

A lab-on-a-chip (LOC) system with optical waveguide channels connected to a light source and a miniature spectrometer.

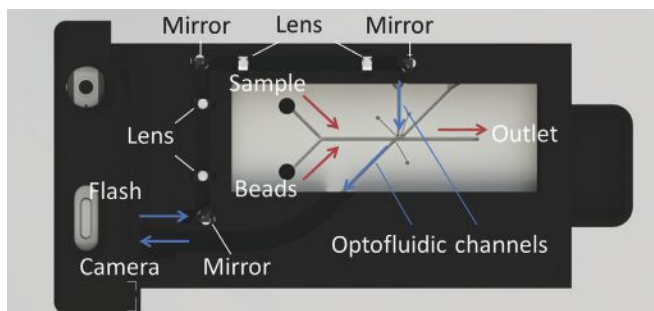

The optical detection components of the LOC system can be replaced with a single smartphone.

Smartphone-based optical detection in LOC

In fact, this kind of optical detection can now be performed with the use of a single smartphone. Modern smartphones possess both a light source and a light detector: a white LED used as a camera flash and a digital camera used as an image detector. The white LEDs in many smartphones are very bright, offering sufficient power for use as a light source for optical detection. Meanwhile, the resolution and sensitivity of smartphone digital cameras have already surpassed those of standalone, compact digital cameras.

Our laboratory has recently replaced the separate light source, optical fibers, and miniature spectrometer of an LOC system with a single smartphone for measuring Mie scatter of particle immunoagglutination assays. The light from the smartphone's white LED is guided through a series of lenses and mirrors and finally into the optical waveguide channel of the LOC. Mie scatter from the LOC microchannel is likewise collected with an optical waveguide channel and delivered to the smartphone's digital camera. A separate laptop computer is not necessary because the data collection and processing can be done using a software application designed for the smartphone.

It is also possible to use the same smartphone-based optical detection for the fluorescent quantification of RT-PCR, eliminating the need for a separate gel electrophoresis step. If an appropriate LOC pattern is prepared to conduct various

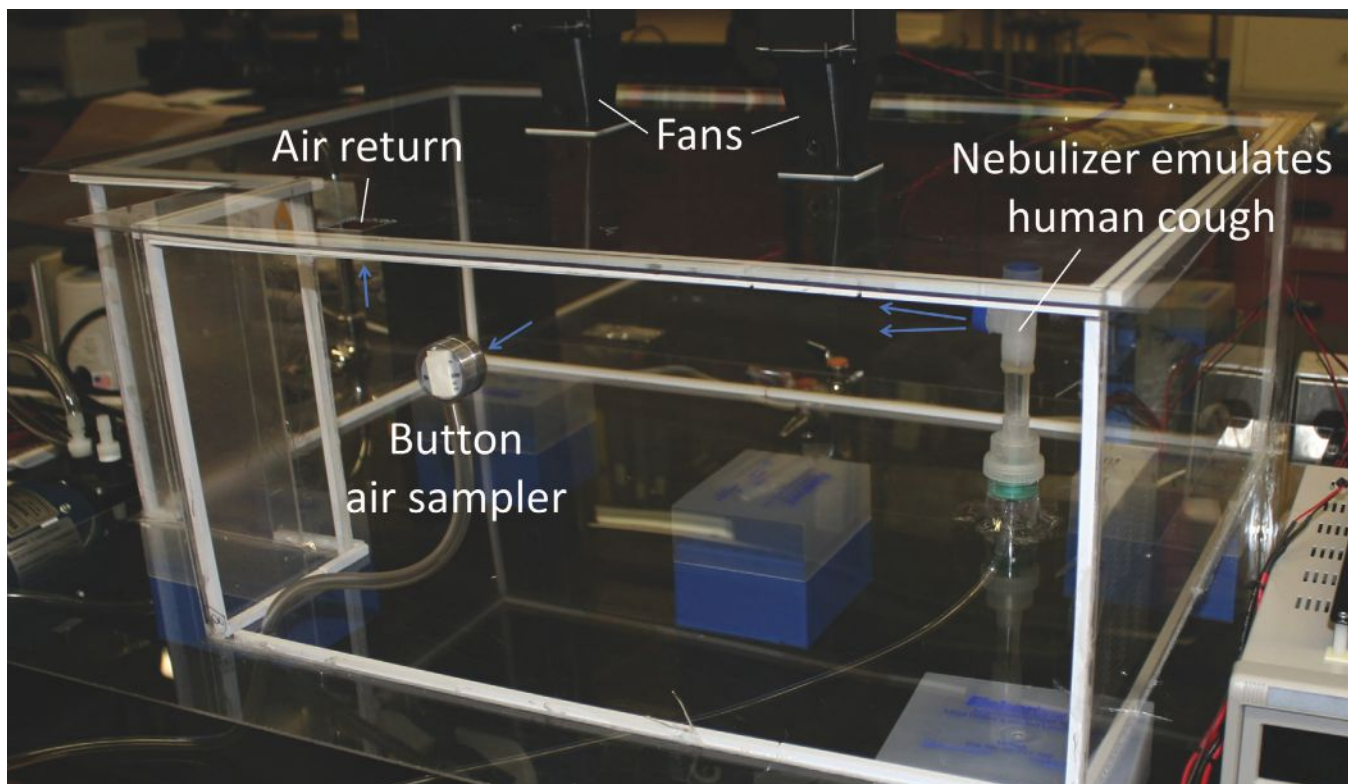

A classroom mockup built to study the distribution of influenza-containing aerosols under various ventilation conditions. The nebulizer (containing influenza solution) simulates human coughs, and the button air sampler collects aerosols at various locations.

portions of RT-PCR, then the same optical detection components can be implemented around the LOC to quantify the fluorescent signals during thermocycling (of RT-PCR). Whether it is based on RT-PCR or immunoassay, the smartphone-based LOC can provide a handheld, near-real-time, and sensitive solution for flu detection at the point of care or in the field.

Sampling for flu detection

Samples for flu detection are typically collected with a swab from the patient's nose or throat. These samples are highly viscous and contain lots of glycoproteins and antibodies that may interfere with both RT-PCR and immunoassays. Appropriate sample pretreatments are necessary, particularly centrifugation or filtration (plus gene extraction for RT-PCR).

Another sampling method is the collection of aerosols over a substantial period of time, since influenza spreads as aerosols through coughs or sneezes. Commercial air samplers that use filter paper and a vacuum pump can be used to capture these aerosols. Because these samplers have been shown to successfully capture airborne pathogens, including influenza, our laboratory has used them in conjunction with LOC biosensors. While these aerosol samples may contain much less mucus, there are large amounts of dust particles that can interfere with RT-PCR or immunoassay. Therefore, centrifugation or filtration is still necessary.

Although centrifuging has been demonstrated on an LOC platform, it is generally considered cumbersome and inappropriate at the point-of-care or field-deployable level. Filtration, however, can easily be implemented, especially with a syringe equipped with a filter (syringe filter). There are a couple of drawbacks with this approach: it requires human labor, and the person-to-person variation can lead to significant variances in assay results. LOC-based filtration could offer an alternative, eliminating human labor and ensuring reproducible assay results. However, implementing porous membrane structures within a microchannel has been a serious challenge in LOC applications, and it has not always been successful when dealing with smaller biomolecules such as viruses (including influenza).

Paper-based LOC for flu detection

LOCs are typically fabricated using silicon or plastic substrates, but they can also be fabricated on paper (cellulose fibers) as a low-cost, field-deployable, and easy-to-use alterna-

tive to conventional LOC devices. There is also another major advantage of paper-based LOCs for flu detection: the paper fibers can serve as a filter for various types of flu samples.

If a paper LOC can be used for flu detection, why can't we use it with smartphone-based optical detection? Smartphone detection can also eliminate issues related to the inhomogeneity of cellulose fibers since it can average the optical signals over a substantial area and over different col-

ors (when a white LED flash or white ambient light is used). This is not possible with conventional spectrophotometric analyses. Toward this end, our laboratory has recently created a multichannel paper LOC combined with smartphone detection. The paper LOC is preloaded with antibody-conjugated submicron particles, and the sample flows through the paper fibers by capillary force while unwanted contaminants are effectively filtered out. The smartphone is tilted at a predetermined, optimized angle for the best Mie scatter detection using a software application that measures the extent of Mie scatter coming from each channel. Although this work was demonstrated for Salmonella detection, it can easily be adapted to monitor flu.

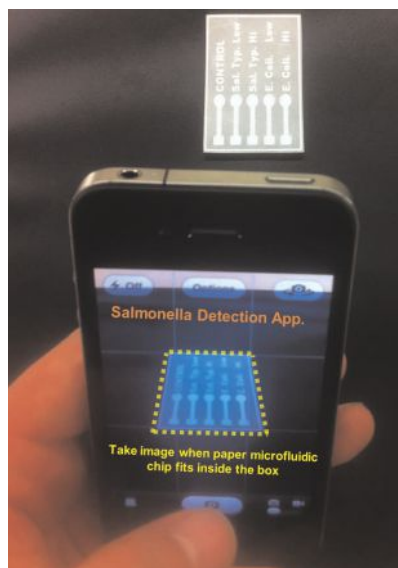

A lab-on-a-chip (LOC) system with optical waveguide channels connected to a light source and a miniature spectrometer.

News to date

Currently, there is much discussion about using smartphones for healthcare applications, commonly referred to as "mHealth." Some of these discussions focus on smartphones' data storage ability for medical records (especially imaging data), especially considering the "cloud" environment in conjunction with WiFi or 3G/4G LTE. Other discussions have focused on attaching a small objective lens to the smartphone camera so that the smartphone can be used as a portable microscope. More recently, a smartphone has been used as an optical sensor to read a signal from a capillary channel (for simple biological assays such as cell sorting) or from a lateral-flow assay (a common format for pregnancy tests). Combining more advanced types of LOC, especially paper-based LOCs, with smartphone detection is something entirely new. It has great potential for monitoring the presence of flu in humans, animals, and the environment, and it requires only a piece of paper and a smartphone app. And it is not limited to flu; smartphone-based detection with a paper LOC can be applied to any type of public health or environmental monitoring application.

ASABE member Jeong-Yeol Yoon, Associate Professor, Department of Agricultural and Biosystems Engineering, The University of Arizona, Tucson, USA, jyoon@email.arizona.edu.



The chicken that isn't: Soy chicken hits commercial market

In Brief: ASABE member **Fu-hung Hsieh, P.E.**, professor of biological engineering and director of graduate studies at the University of Missouri College of Agriculture, Food, and Natural Resources, has developed a soy-based food product that is now sold in grocery stores nationwide.

Hsieh is the developer of a meat analog marketed under the Beyond Meat brand name. Hsieh's research was licensed to Beyond Meat, which opened a factory to produce it in Columbia, Mo. The product is made from powdered soy but mimics the taste and texture of a chicken breast. The soy chicken is aimed at the vegetarian market, but it also offers meat eaters a healthy alternative.

Soy provides important bioactive components, such as isoflavones, which help maintain healthy bones and prevent prostate, breast, and colorectal cancers. Soy foods are a good source of essential fatty acids and contain no cholesterol.

Eating soy protein may help reduce the risk of heart disease by lowering blood cholesterol and increasing the flexibility of blood vessels. The FDA has approved a health claim stating, "Twenty-five grams of soy protein in a daily diet low in saturated fat and cholesterol can help reduce total and LDL cholesterol that is moderately high to high."



ASABE member **Fu-hung Hsieh, P.E.**, examines his soy-based product in his lab. *Photos by Randy Mertens, courtesy of CAFNR.*

Hsieh's product not only replicates the taste of chicken, which is fairly easy to do, but also mimics its fibrous texture and appearance, which is difficult. Hsieh has spent more than 20 years researching the process, which uses heat and an extruder to convert powdered soy into a product that tastes and feels like chicken breast meat.

Meat alternatives are becoming an increasingly big part of the world's diet. Meat substitutes are purchased by vegetarians, chefs wanting faster preparation time, people with food allergies, or shoppers looking for an inexpensive source of high-quality protein. Hsieh is now working on a new soy product that replicates the taste and eating experience of steak.

Prior to beginning his academic career, Hsieh was awarded several patents for his innovations in cereal and dried fruit while working as a senior research engineer for Quaker Oats Co. In addition to his work as a professor, Hsieh is a co-leader of the

Food for the 21st Century Bioprocessing and Biosensing Center at the University of Missouri.

Hsieh's research is documented in a video: www.youtube.com/watch?feature=player_embedded&v=C_0_pZE1VoE. The company that distributes a meat alternative created by Hsieh is among CNN's top 10 list of companies to watch: <http://cafnrnews.com/2013/10/tv-business-honor/>.

For more information, contact **Randy Mertens**, CAFNR Coordinator of Media Relations, mertensr@missouri.edu.

That certain glow: Delayed fluorescence helps monitor health of plants

In Brief: Don't look now, but your plants are glowing. Research at the University of Missouri College of Agriculture, Food, and Natural Resources is investigating delayed fluorescence, which may someday help farmers monitor the health of their crops to more accurately apply fertilizers, water, and pesticides.

This research is very new," says **ASABE member Jinglu Tan**, director of food systems and biological engineering at CAFNR and one of the world's few researchers in delayed fluorescence. "No, I can't scan a field today with a camera and tell you what's wrong with it yet, but such technology is possible in the future."

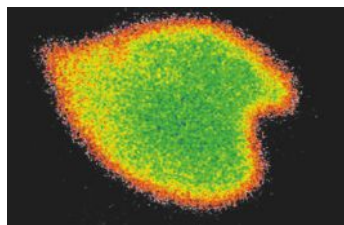

The glow of a plant leaf taken by CAFNR. The color and density of the glow indicate the relative health of the plant.

The glow is only visible in darkness through an ultrasensitive camera. The emissions are caused by leakage of electrons from the sun's energy, which is captured by the plant during photosynthesis. The plant's naturally occurring emissions are recorded by the camera and analyzed through advanced computer algorithms.

The glow patterns change according to the plant's state of health and environmental stimuli. Tan's research has shown that plants glow differently and uniquely during drought or after exposure to herbicides and other chemicals. Tan said measuring this glow can tell scientists about changes in the plant's health long before other observation methods.

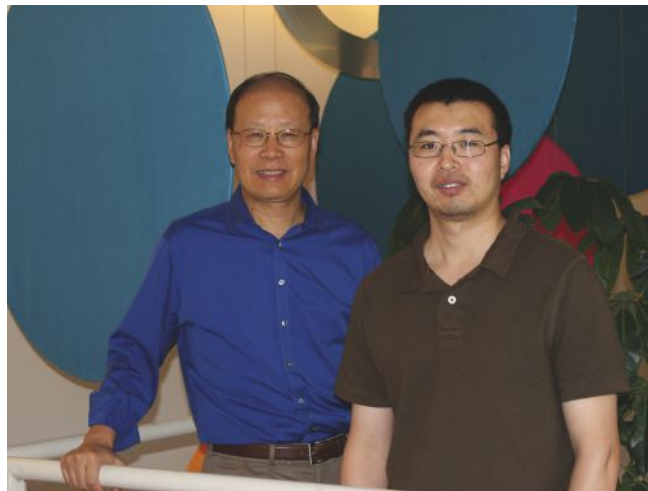

ASABE member Jinglu Tan, left, director of food systems and bioengineering at CAFNR, and **David Guo**, a postdoctoral research associate who has been working on this research with Tan for eight years. Photos by Randy Mertens, courtesy of CAFNR.

In addition to using the glow to quantify the physiological status of plants, Tan is also hoping to use the plant's glow as a biosensor to detect changes in the air or water. This research could be a new tool for monitoring the environment, said David Guo, a postdoctoral research associate who has been working on this research with Tan for eight years. Changes in a plant's glow can show if there is an uptick in air pollution or an increase in certain chemicals in the groundwater.

The trick will be learning how to interpret the glow more accurately. Guo and Tan hope to develop a portable instrument that can give a precise analysis of a plant from a scan of a leaf.

For more information, contact **Amy Zuroweste**, Mizzou College of Agriculture, Food and Natural Resources, amzyt3@mail.missouri.edu.

Alternative natural and synthetic rubber for Ohio and the United States

In Brief: Dandelions as a cash crop? It sounds like a bad joke, but a certain dandelion grown on a commercial basis could provide Ohio farmers with a new source of income and provide Ohio manufacturers with a home-grown raw material.

The dandelion in question is *Taraxacum kok-saghyz*, more commonly known as the Russian dandelion, a native of Kazakhstan. Its roots are a source of high-grade latex, comparable to that of the Malaysian rub-

ber tree, which is currently America's main source of natural rubber. Initial benchtop trials have demonstrated that rubber can be extracted from Ohio-grown rubber dandelions, which have been given the trade name Buckeye Gold.

Natural rubber is so important in the manufacture of tires, especially big tires that take a lot of stress, like those on airplanes and tractors, that it is considered a strategic material. But the supply of Malaysian rubber has been declining. According to **ASABE member Katrina Cornish**, professor in the Department of Food, Agricultural, and Biological Engineering at Ohio State University, supplies of natural rubber (NR, imported from tropical countries) and synthetic rubber (SR) are suffering shortfalls, and as a result, raw material prices have risen to all-time highs of \$6.6 per kg (\$3 per lb)



Buckeye Gold dandelions 12 weeks after planting in spring 2013. The beds are 2.4 m (8 ft) wide, in-row spacing is 11.4 cm (4.5 in.), and between-row spacing is 17 to 20 cm (7 to 8 in.).

for solid rubber for tires—a six-fold increase in two years.

The situation is further exacerbated by political instability in Arabia and Africa, because prices of SR and NR are closely linked to petroleum prices. Furthermore, 2011 saw serious shortfalls in butadiene, the petroleum-derived monomer from which 70% of SR is polymerized. Tropical NR cannot keep up with demand, and a shortfall of 1.5 million metric tons (1.7 million tons) per year is expected by 2020. Meanwhile, the U.S. needs 1.2 million metric tons (1.3 million tons) of NR per year and 1.7 million metric tons (1.9 million tons) of SR per year.

Buckeye Gold dandelions, capable of producing up to 18% NR (dry weight basis) in their roots, were obtained from USDA germplasm collected in Kazakhstan. Initial benchtop trials demonstrated that rubber can be extracted from Ohio-grown Buckeye Gold dandelions in the form of solid rubber or in the form of latex. The solid rubber has properties very similar to Hevea natural rubber and can probably be blended with NR as a drop-in material. Two pilot-scale crop processing plants have been installed in Wooster, Ohio, to make solid and latex rubber from alternative crops, including the Ohio-grown rubber.

Last year, the largest North American planting since World War II took place as 98 km (61 miles) of Buckeye Gold was transplanted into 3.2 ha (8 acres) on three north-east Ohio farms. Post-harvest storage experiments demonstrated that the rubber-containing roots can be

stored for several months without loss of rubber quantity or quality. The goal of 100% crop consumption has led to successful direct fermentation of the plant's inulin, a naturally occurring polysaccharide, into butanol and as a feedstock for bio-butadiene production.

Domestic rubber production in Ohio will generate jobs in agriculture, processing, supply chain, construction, and in science and extension. An 8.4% natural rubber market share in North America will generate at least 3,600 new jobs. The first 250 jobs are expected by the end of 2015.

For more information, contact **ASABE member Katrina Cornish**, Endowed Chair and Ohio Research Scholar, Department of Food, Agricultural and Biological Engineering, The Ohio State University, cornish.19@osu.edu; **Matt Kleinhenz**, kleinhenz.1@osu.edu; or **Thaddeus Ezeji**, ezeji.1@osu.edu.



OSU students and staff planting Buckeye Gold dandelions on an Ohio farm.

Crafting a better enzyme cocktail to turn plants into fuel faster

In Brief: Tapping fungus to unlock energy, scientists look to create a potent blend of enzymes to transform materials like corn stalks and wood chips into fuels. They have developed a test that should turbocharge their efforts.

The new research is part of a worldwide effort to create fuels from plants that are plentiful and aren't part of the food supply. It's possible to do this today, but the process is costly, laborious, and lengthy. The findings by chemists and colleagues at the Department of Energy's Pacific Northwest National Laboratory open the possibility that laboratory research that now takes months could be reduced to days, and that scientists will be able to assess more options for biofuel development than is possible today.

Many of today's efforts revolve around the fungus *Trichoderma reesei*, which introduced itself to U.S. troops during World War II by chewing through their tents in the Pacific theater. Seventy years later, *T. reesei* is a star in the world of biofuels because of its ability to churn out enzymes that chew through molecules like complex sugars.

The breakdown of large sugar polymers into smaller compounds that can then be further converted to fuel compounds is the final, crucial step in the effort to make fuels from materials like switchgrass and corn stalks. These plants and many others are full of energy, stored in carbon bonds, which can be converted into fuel, if scientists can find ways to free the compounds that store the energy from the tough structural material, known as lignocellulose, which holds the plants together.

Lignocellulose is what stands between you and a tankful of fuel created from corn stalks or switchgrass.

"The ultimate goal is to begin with a plant material like corn stalks, for instance, and to subject it to a cocktail of enzymes that would convert those plants to fuel," said Aaron Wright, who led the PNNL team. "It takes a series of steps to do that, and the cost has to come down if these fuels are to compete seriously with traditional hydrocarbon-based fuels."

T. reesei chews through materials naturally, cutting through the chemical "wrapping" much like a person with scissors cuts through a tightly wrapped ribbon around a gift. The fungus actually makes dozens of cutting enzymes, each

of which attacks the wrapping differently. Chemists like Wright are trying to combine and improve upon the best ones to create a potent chemical cocktail, a mix of enzymes that accomplishes the task super-efficiently. That would bring down the cost of producing biofuels.

Wright's study focused on a subset of the fungus's collection of cutting tools, on enzymes known as glycoside hydrolases. It's their job to break down complex sugars into simple sugars, a key step in the fuel production process.

To assess the effectiveness of mixtures of these enzymes, scientists must either measure the overall performance of the mixture, or they must test the component enzymes one at a time to see how each reacts to different conditions like temperature, pressure, and pH.



Trichoderma reesei

Wright's team developed a way to measure the activity of each of the ingredients simultaneously, as well as the mixture overall. Instead of needing to run a series of experiments, each focusing on a separate enzyme, the team runs one experiment and tracks precisely how each of dozens of enzymes reacts to changing conditions.

A series of experiments detailing the activity of 30 enzymes, for instance, now might be accomplished in a day or

two with the new technology, compared to several months using today's commonplace methods, the scientists say.

The key to the work is a chemical probe the team created to monitor the activity of many enzymes at once. The heart of the system, known as activity-based protein profiling, is a chemical probe that binds to glycoside hydrolases and gives off information indicating just how active each of those enzymes is moment by moment.

"Identifying exactly which enzymes are doing most of the work you need done is crucial for making this an economical process," said Wright. "We're trying to keep tabs on the precise activity of every enzyme as each goes through a very complex process, as conditions like temperature and pH vary, to measure their activity through each stage."

"We can test the whole mixture, and we can also tease out each individual contribution. People have not been able to do that all at once before," added Wright.

For more information, contact **Tom Rickey**, News & Media Relations, Pacific Northwest National Laboratory, tom.rickey@pnnl.gov.



© Sabina Pensek | Dreamstime.com

Study results could lead to super-crops such as faster growing drought-resistant rice.

Mystery solved: How some plant species evolved super-efficient photosynthesis and what steps led to that change

In Brief: Around 3% of all plants use an advanced form of photosynthesis, which allows them to capture more carbon dioxide, use less water, and grow more rapidly. Overall, this makes them over 50% more efficient than plants that use the less efficient form. A new study has traced back the evolutionary paths of all the plants that use advanced photosynthesis, including maize, sugar cane, and millet, to find out how they evolved the same ability independently, despite not being directly related to one another.

Using a mathematical analysis, mathematician Iain Johnston from Imperial College London and plant biologist Ben Williams from the University of Cambridge uncovered a number of tiny changes in the plants' physiology that, when combined, allow them to grow more quickly, use only a third as much water as other plants, and capture around 13 times more carbon dioxide from the atmosphere.

Together, these individual evolutionary advances make up a "recipe" that could be used to improve key agricultural crops

that use the less efficient form of photosynthesis. Johnston and Williams say this knowledge could be used to breed super-crops, such as faster growing, drought-resistant rice.

The scientists came together to test whether a new mathematical model of evolution could be used to unpick the evolutionary pathways that led to the advanced photosynthesis.

"My main interest is in using math tools to make some concrete progress in a problem of real biological and social value," said Johnston. "Encouragingly for the efforts to design super-efficient crops, we found that several different pathways lead to the more efficient photosynthesis—so there are plenty of different recipes that biologists could follow to achieve this."

Julian Hibberd from the University of Cambridge, said, "This is not only an interesting mathematical result, it should help biological scientists to develop crops with significantly improved yields to feed the world. Like the proverbial roads that all lead to Rome, Ben and Iain have shown that there are many routes taken by plants in the evolutionary process."

The next step for the biologists is to recreate the natural evolution of the more advanced photosynthesis by mirroring the genetic and physiological changes in simple laboratory plants, and eventually in rice.

For more information, contact **Simon Levey**, Communications and Public Affairs, Imperial College London, s.levey@imperial.ac.uk.

Spinning CDs to clean sewage water

In Brief: Scientists have found a potential new use for old music CDs: coating disks in photocatalytic compounds and spinning them to clean water.

Audio CDs, all the rage in the 1990s, seem increasingly obsolete in a world of MP3 files and iPods, leaving many music lovers with the question of what to do with their extensive CD collections. While you could turn your old disks into a work of avant-garde art, researchers in Taiwan have come up with a more practical application: breaking down sewage.

“Optical disks are cheap, readily available, and very commonly used,” says Din Ping Tsai, a physicist at National Taiwan University. Close to 20 billion disks are already manufactured annually, the researchers note, so using old disks for water treatment might even be a way to cut down on waste.

Tsai and his colleagues from National Taiwan University, National Applied Research Laboratories in Taiwan, and the Research Center for Applied Sciences in Taiwan used the

large surface area of optical disks as a platform to grow tiny, upright zinc oxide nanorods about a thousandth the width of a human hair. Zinc oxide is an inexpensive semiconductor that can function as a photocatalyst, breaking apart organic molecules like the pollutants in sewage when illuminated with UV light.

While other researchers have experimented with using zinc oxide to degrade organic pollutants, Tsai’s team is the first to grow the photocatalyst on an optical disk. Because the disks are durable and able to spin quickly, contaminated water that drips onto the device spreads out in a thin film that light can easily pass through, speeding up the degradation process.

The Taiwanese team’s complete wastewater treatment device is approximately one cubic foot in volume. In addition to the zinc oxide-coated optical disk, the device consists of a UV light source and a system that recirculates the water to further break down the pollutants.

The research team tested the reactor with a solution of methyl orange dye, a model organic compound often used to evaluate the speed of photocatalytic reactions. After treating a half-liter solution of dye for 60 minutes, they found that over 95% of the contaminants had been broken down. The device can treat 150 mL of wastewater per minute, the researchers say.

The spinning disk reactor is small, consumes little power, and processes contaminated water more efficiently than other photocatalytic wastewater treatment methods, Tsai says. The device could be used on a small scale to clean water contaminated with domestic sewage, urban runoff, industrial effluents, and farm waste. Going forward, the team is also working on ways to increase the efficiency of the reactor, and Tsai estimates that the system could soon be improved to work even faster, perhaps by using layers of stacked disks.

For more information, contact **Lyndsay Meyer**, The Optical Society, lmeyer@osa.org.

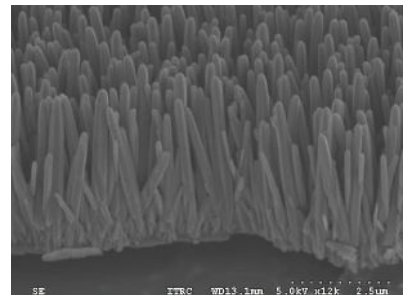

This scanning electron microscope image shows tiny nanorods growing on the disk. Photo credit: Din Ping Tsai, National Taiwan University.

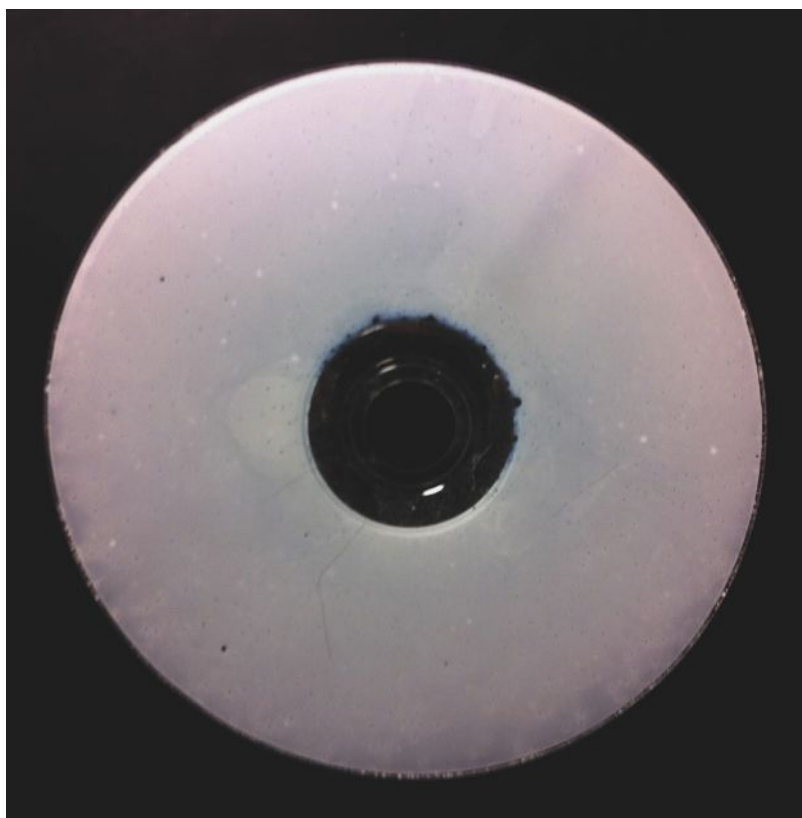

An optical disk entirely coated with zinc oxide nanorods. Photo credit: Din Ping Tsai, National Taiwan University.



Great Plains producers could profit from spring canola crops

In Brief: Computer modeling by scientists at the USDA suggests that spring canola has the potential to become a profitable bioenergy crop for farmers in the semi-arid Central Great Plains.

The research by ARS agronomist David Nielsen and others could provide producers with alternatives for stretching scarce water supplies and increasing cash crop production. Nielsen, who works at the ARS Central Great Plains Research Station in Akron, Colo., worked with colleagues to combine existing plant growth computer models and generate spring canola production simulations. Then they ran their results from the combined model with 16 years of regional weather data, four different soil water levels at planting time, and other site-specific information to generate spring canola yield estimates for nine locations in Nebraska, Colorado, and Kansas.

Results from their crop simulations suggested the highest yields would be produced in the north-central area near Champion, Neb., and the lowest yields would be produced in the south-central area near Walsh, Colo. When 75% of the soil water was available for crop use at planting, the model indicated that six of the sites had more than a 70% probability of producing a canola seed yield of at least 400 kg (900 lbs) per acre.

Using the average simulated yields at each location, the researchers ran an economic analysis that indicated average net returns could range from \$67 to \$189 per 0.4 ha (1 acre), depending on plant-available soil water levels. Simulations produced positive average net returns for five sites: Garden City and Tribune City, Kan.; and Champion, McCook and Sidney, Neb. These positive net returns were predicted even when only 25% of the soil water was available for crop use at planting.

Nielsen used these simulation results to develop a simple decision support tool for canola production and economic analysis that can be used by farmers for canola planning.

For more information, contact **Ann Perry**, Public Affairs Specialist, Ann.Perry@ars.usda.gov. *Photo by David Nielsen, courtesy of USDA-ARS.*

professional opportunities

PURDUE
UNIVERSITY

FACULTY POSITION IN WATER RESOURCES AND ECOHYDROLOGIC ENGINEERING

POSITION: Assistant Professor of Agricultural and Biological Engineering.

RESPONSIBILITIES: This is an academic year, tenure track, teaching and research position. Develop a nationally and internationally recognized research and teaching program focused on environment and natural resources engineering, modeling of hydrologic and ecological processes, and/or the restoration of aquatic ecosystems. Research areas may include designing urban low impact development and agricultural conservation practices, stream and riparian area restoration engineering, wetland design for optimizing ecological functions, the sustainability of current water resource management with a focus on the changing demands of agriculture, industry and society; impact of land management changes on water quality and quantity and corresponding impact on ecosystems; and hydrological transport of chemicals and micro-organisms and associated ecological response. The successful candidate will have a distinguished academic record, develop an independent research program and will teach undergraduate and graduate level courses in Water Resources Engineering.

QUALIFICATIONS: Ph.D. or equivalent doctoral level degree in Agricultural, Biological, Civil Engineering or closely related field with strong research emphasis on water resources modeling and sustainability is required. PE licensure is desired.

CLOSING DATE: Review of applications will begin on February 1, 2014 and will continue until the position is filled.

APPLICATION MATERIALS: Applications should include a letter of interest, CV, academic transcripts.

MATERIALS: Statements of approach and vision for research and teaching, and names and contact information for three references. Please go to: <https://engineering.purdue.edu/Engr/InfoFor/Employment> to apply. A background check is required for employment in this position.

CONTACT: Questions regarding the position may be addressed to the chair of the search committee: Vincent Bralts – 765-494-1177 – Email: abejob@ecn.purdue.edu. Please read the full position description located here: <https://engineering.purdue.edu/ABE/AboutUs/NewsAndEvents/Announcements/water-resources-and-ecohydrologic-engineering-position-announcement>.

Purdue University is an equal opportunity / equal access/ affirmative action employer fully committed to achieving a diverse workforce.

Resource is published six times per year: January/ February, March/April/, May/June, July/August, September/October, and November/December. The deadline for ad copy to be received at ASABE is four weeks before the issue's publishing date.

For more details on this service, contact Melissa Miller, ASABE Professional Opportunities, 2950 Niles Road, St. Joseph, MI 49085-9659, USA; 269-932-7017, fax 269-429-3852, miller@asabe.org, or visit www.asabe.org/resource/persads.html.



Agricultural Engineering Associates
John A. George, PE
 johng@agengineering.com

1000 Promontory Drive
 PO Box 4
 Uniontown, KS 66779

www.agengineering.com
 Phone: 800-499-5893
 Cell: 620-704-9122
 Fax: 620-756-4600

cwa
CURRY-WILLE & ASSOCIATES
CONSULTING ENGINEERS P.C.

Animal and Livestock Facility Design
 Feed and Grain Processing and Storage
 Fertilizer/Pesticide Containment Design
 TSP/Manure Handling Design
 Agricultural Research Facilities

AMES, IA
515-232-9078
WWW.CURRYWILLE.COM

DIEDRICHS & ASSOCIATES, Inc.

Integrated Product Development Services

Vehicles, Implements and Tools
 Engineering, Design and Analysis
 Prototype Build, Test and Evaluation,
 40,000 sq. ft. Experimental Shop.

Brad Meyer, P.E. Cedar Falls, IA
 319-266-0549 www.iowaengineer.com

INDUCTIVE ENGINEERING

DALE GUMZ, P.E., C.S.P.
 10805 230th Street
 Cadott, WI 54727-5406

- Accident Reconstruction
- Mechanical & Electrical
- Safety Responsibilities
- Product & Machine Design

715-289-4721 dgumz@centurytel.net
 www.inductiveengineering.net

J.M. Miller Engineering, Inc.
 James M. Miller, PE, PhD, President

Idaho: Boise – Twin Falls
 888-206-4394

Michigan: Ann Arbor
 734-662-6822

www.millerengineering.com
 e-mail: miller@millereengineering.com

Agricultural, Chemical, Mechanical, & Forensic Engineers;
 Dairy & Food Processing Safety – Tractor & Harvester Safety – Equine & Bovine
 Accidents; Guarding & Entanglement Accidents – Silage & Grain Storage Accidents –
 Warnings, Labeling, & Instruction Manuals – Worker Safety & Health (OSHA & GHS) –
 Chemical Application & Exposures – EPA RCRA, Clean Water, Compliance – Irrigation,
 Riparian, & Hydroelectric

NOHR Engineering Co., LLC

Yankton, South Dakota 57078-4344
Tel: 605-665-1214 Fax: 605-665-8060
 www.nohreengineering.com
 E-mail - nohr@nohreengineering.com

Bulk materials - Grain & Feed Storage - Handling & Process
 Systems including bins, silos, docks, and equipment -
Agricultural, Commercial & Residential Structures, Vehicles,
Equipment & Process -
Failure, Cause & Origin Inspections, Opinions and Reporting
 Domestic and International



fsemke@semke.com

154 Hughes Lane
 St. Charles, MO 63301

St. Louis • Kansas City • Chicago

T 636.896.9995
F 636.896.9695
C 314.603.6382

Fred B. Semke, P.E.
 Principal Engineer

www.semke.com



TIMBER TECH ENGINEERING, INC.
 22 Denver Road, Suite B
 Denver, PA 17517
 Phone - 717-335-2750 FAX - 717-335-2753

AG ENGINEERING SERVICES

- AGRICULTURAL BUILDING DESIGN
- MANURE STORAGE SYSTEM DESIGN
- CAFO AND NPDES PERMITS
- FARMSTEAD EXPANSION PLANNING

STRUCTURAL ENGINEERING SERVICE

- STRUCTURAL DESIGN OF WOOD, STEEL AND CONCRETE STRUCTURES
- ENGINEER CERTIFICATIONS
- STRUCTURAL INSPECTIONS

Visit our web site: www.timbertecheng.com or
 E-mail us tt@timbertecheng.com

www.IRRIGATION-MART.com

300 S. Service Road, E.
 Ruston, LA 71270-3440
 Ph: 800-SAY RAIN (729-7246)
 Fax: 318-255-7572
 info@irrigation-mart.com



Josh Brown, Bio Systems Engineering, Monitoring;
Rel Gray, Civil Engineering;
Michael Pippen, Mechanical Engineer, P.E., CID, CAIS
Robin Robbins, Agronomist;
Jay Robbins, Agricultural Engineer, P.E., CID, CAIS, TSP;
Jackie Robbins, CEO, CID, Ph.D., Agricultural Engineer, P.E.

Your personal or company consultant business card could appear here.

For information on rates, contact
 Sandy Rutter

Resource: Engineering & Technology for a Sustainable World
 2950 Niles Rd.
 St. Joseph, MI 49085
 tel: 269-932-7004; fax: 269-429-3852; rutter@asabe.org
 http://www.asabe.org/publications/resource-magazine.aspx

The Shape of Things to Come

Leon Schumacher

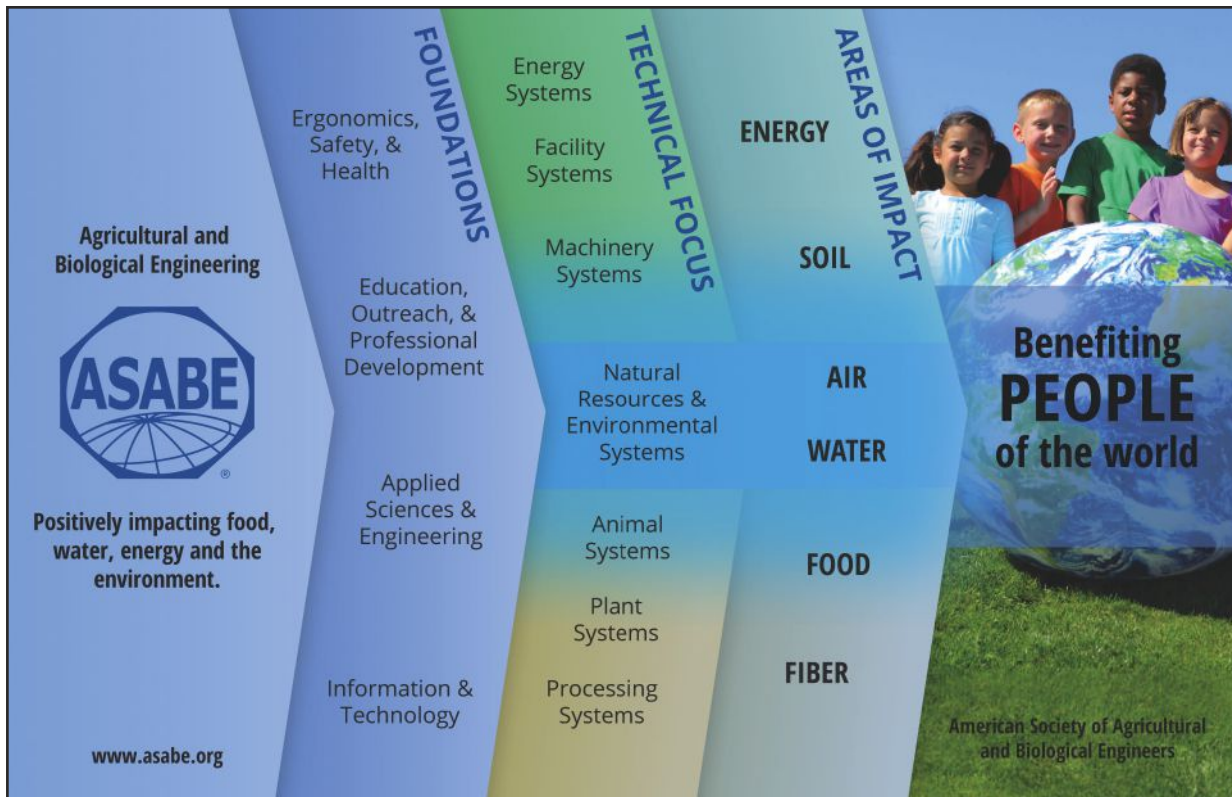

Over the past two years, the ASABE Board of Trustees has undertaken a major effort to examine the Society's effectiveness in meeting the needs of its members. One component of that effort has been to describe who our members are and what they do—and to convey this accurately and succinctly through a single piece of artwork that can be used for external marketing.

Over many months, graphic representations of ASABE's purpose and organization have been devised and revised. Significant member input has strengthened each iteration—expanding nine technical areas to eleven, for example. Earlier this fall, a new version was presented to the full membership through an online survey. That effort generated more than 700 responses, approximately 80 percent of which were supportive of the general concept. Comments and recommendations received in the survey have been reviewed and incorporated into the final artwork, which is presented below.

With this marketing piece complete, you might now ask, "What's next?"

One of the next steps will be to determine how the current technical divisions relate to the new technical descriptors. To that end, division leadership will soon be asked to consider a re-alignment or renaming of technical divisions relative to the eleven technical areas identified in the artwork. The goal of the reconfiguration, of course, is to better describe where someone fits within ASABE. This reconfiguration relates only to the way the technical interest areas of ASABE are organized and represented. Groups such as councils, communities, geographic sections, awards, and leadership committees will not be affected. Additional details are forthcoming and will be communicated through the ASABE website and by email to the membership.

Thanks again for all your input during this long process.

ASABE Member Leon Schumacher, Professor, Department of Agricultural Systems Management, University of Missouri, Columbia, USA; schumacherl@missouri.edu.

MARK YOUR CALENDAR!



2014 ASABE and CSBE | SCGAB Annual International Meeting



Montreal

July 13 - 16, 2014



Meeting Highlights

- More than 1,000 Technical and Poster Presentations
- Specialty Sessions with invited speakers, panel and round-table discussions
 - Professional Development Hours/Credits
 - Technical and Cultural Tours
 - Networking Opportunities
 - Career Fair
 - ASABE Global Engagement Day
 - Foundation Dinner Cruise

Registration Opens March 1, 2014

Visit the new ASABE 2014 Website at www.asabemeetings.org for full conference details, key deadlines, conference registration, sponsorship and exhibit opportunities and travel details.

