

# **BOAT** **NEBRASKA**

**A Course on  
Responsible Boating**



**Sponsored by**



**Nebraska Game &  
Parks Commission**

**2017 Edition**

# NEBRASKA GAME AND PARKS COMMISSION

## MISSION

The mission of the Nebraska Game and Parks Commission is stewardship of the state's fish, wildlife, park, and outdoor recreation resources in the best long-term interests of the people and those resources.

To accomplish that purpose, the commission plans and implements its policies and programs efficiently and objectively; maintains a rich and diverse environment in Nebraska's lands and waters; provides outdoor recreation opportunities; manages wildlife resources for the maximum benefit of the people; and attempts to help Nebraskans appreciate their role in the natural world.

## BOATING

The Boating Section of the Law Enforcement Division of the Nebraska Game and Parks Commission is responsible for:

- Administration: Boat registration data entry and monitoring, new legislation, and general oversight of the program budget
- Boating Safety Education: Certification of instructors, distribution of educational materials, certification of students, and certification of education classes
- Boating Law Enforcement: Patrols, accident investigation, and safety exams



Nebraska Game and Parks Commission  
2200 N. 33rd St.  
Lincoln, NE 68503  
tel: 402-471-0641

The logo features a red sailboat icon to the left of the word "BOAT" in large, blue, 3D-style letters. Below "BOAT" is the word "NEBRASKA" in large, white, 3D-style letters with a blue outline.

# BOAT NEBRASKA

## A Course on Responsible Boating

**Sponsored by**



**Nebraska Game &  
Parks Commission**

**2017 Edition**



Contents are approved by the National Association of State Boating Law Administrators and recognized by the U.S. Coast Guard, contingent on state-specific information being included with this course and course approval by the Boating Law Administrator of the state where it is taught.



**Nebraska boating regulations require children under 13 to wear a life jacket while on board any vessel.**

Published by Boat Ed, a division of Kalkomey Enterprises, LLC, 14086 Proton Road, Dallas, TX 75244, 214-351-0461. Printed in the U.S.A.

Copyright © 2004–2017 by Kalkomey Enterprises, LLC. All rights reserved. No part of this publication may be reproduced in any form or by any process without permission in writing from Kalkomey Enterprises, LLC. Effort has been made to make this publication as complete and accurate as possible. All references contained in this publication have been compiled from sources believed to be reliable, and to represent the best current opinion on the subject. Kalkomey Enterprises, LLC is not responsible or liable for any claims, liabilities, damages, or other adverse effects or consequences to any person or property caused or alleged to be caused directly or indirectly from the application or use of the information contained in this publication. NS15-P0417

Danforth is a registered trademark of Tie Down Engineering, Inc.

 **kalkomey™**  
www.kalkomey.com

Photo of Evening Primrose on page 61 and back cover copyright U.S. Fish & Wildlife Service

Copyright © 2017 Kalkomey Enterprises, LLC and its divisions and partners, www.kalkomey.com

1. Review each chapter of this manual and, if available, the BOAT AMERICA video. Complete that chapter's exercise on pages 54–56.
2. Check your answers for the exercise on page 57.
3. Review the information you may have answered incorrectly.
4. Continue in this manner until all chapters have been covered.
5. Upon successful completion of the Certification Exam, you will receive your boater safety certification card.

## What's Included in This Course

This manual presents a wide variety of information, including:

- General information concerning boats and maintenance
- Information to make your boating experience safer and more comfortable
- Tips on how to be a more courteous boat operator
- Laws and regulations to which you must adhere

In general, this information applies to all vessels (powerboats, personal watercraft, and manually driven boats such as sailboats, canoes, etc.). However, in some places, information may apply *specifically* to personal watercraft.

## Where to Find Additional Information

This manual is designed to be an introductory course to meet the boater education needs of recreational boaters. We encourage you to continue to learn more about boating safety.

- For more advanced information, the following publications may be useful:
  - U.S. Coast Guard's *Navigation Rules*
  - *Chapman Piloting: Seamanship and Boat Handling* by Elbert S. Maloney
  - *The Annapolis Book of Seamanship* by Mark Smith and John Rousmaniere
- For additional courses, contact the following organizations:
  - U.S. Coast Guard Auxiliary
  - U.S. Power Squadrons
  - American Sailing Association
  - U.S. Sailing Association

### Chapter One

**Know Your Boat** ..... Pages 2–4

### Chapter Two

**Before You Get Underway** ..... Pages 5–9

### Chapter Three

**Operating Your Boat ... Safely** ..... Pages 10–24

### Chapter Four

**The Legal Requirements of Boating** ..... Pages 25–38

### Chapter Five

**Boating Emergencies ... What to Do** ..... Pages 39–47

### Chapter Six

**Enjoying Water Sports With Your Boat** ..... Pages 48–53

**Chapter Review Exercises** ... Pages 54–56

### Answers to Chapter

**Review Exercises** ..... Page 57

### Required Equipment

**Checklist** ..... Inside Back Cover

## Stay up to date on new boating laws!



Be sure to stay abreast of new boating laws and requirements.

For state boating law information, contact the Nebraska Game and Parks Commission:

- Call 1-402-471-0641
- Visit [www.outdoornebraska.ne.gov/boating/](http://www.outdoornebraska.ne.gov/boating/)

For federal boating laws, visit the U.S. Coast Guard's boating safety website at:

- [www.uscgboating.org](http://www.uscgboating.org)

Information in this manual does not replace what is specifically legal for boating in your state, which is found in state and federal laws.

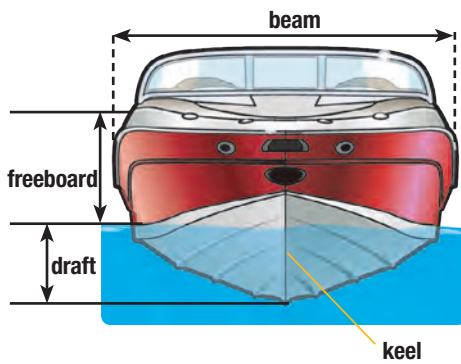

### How Planing Hulls Operate



#### Displacement Mode

A planing hull, when operated at very slow speeds, will cut through the water like a displacement hull.



#### Plowing Mode

As speed increases, a planing hull will have a raised bow, reducing the operator's vision and throwing a very large wake. Avoid maintaining a speed that puts your boat in plowing mode.



#### Planing Mode

Your boat is in planing mode when enough power is applied so that the hull glides on top of the water. Different boats reach planing mode at different speeds.

## The Many Parts of a Boat

Boats come in many styles and shapes, but the names of the different parts remain consistent. Every boat operator should know the following terms and definitions.

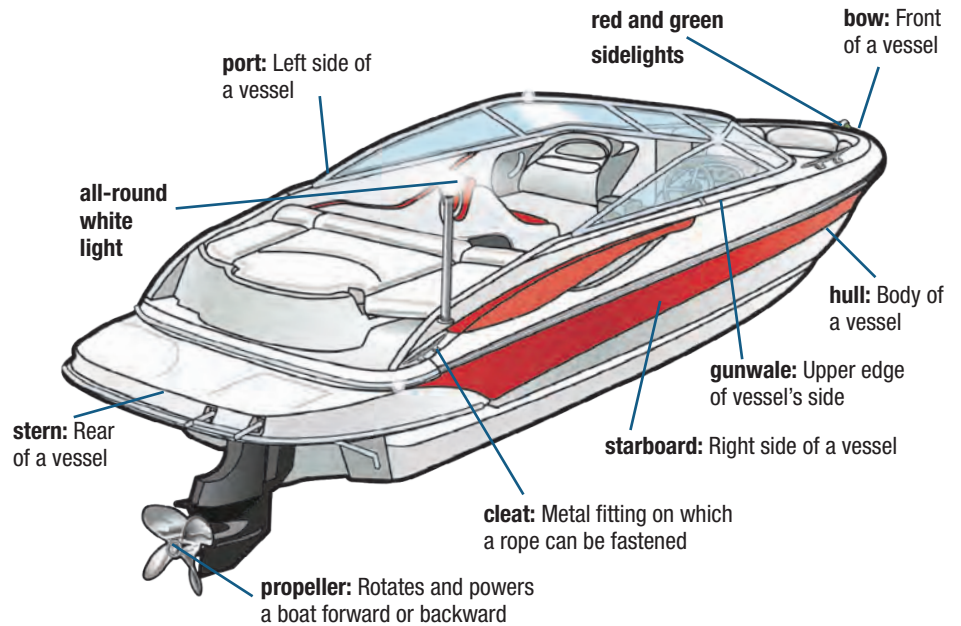

## Types of Boat Hulls

There are two basic types of boat **hulls**—displacement and planing.

- **Displacement Hulls:** Boats with displacement hulls move through the water by pushing the water aside and are designed to cut through the water with very little propulsion.
  - If you lower a boat into the water, some of the water moves out of the way to adjust for the boat. If you could weigh that displaced water, you would find it equals the weight of the boat. That weight is the boat's displacement.
  - Boats with displacement hulls are limited to slower speeds.
  - A round-bottomed hull shape acts as a displacement hull. Most large cruisers and most sailboats have displacement hulls, allowing them to travel more smoothly through the water.
- **Planing Hulls:** Boats with planing hulls are designed to rise up and glide on top of the water when enough power is supplied. These boats may operate like displacement hulls when at rest or at slow speeds but climb toward the surface of the water as they move faster.
  - Boats with planing hulls can skim along at high speeds, riding almost on top of the water rather than pushing it aside.
  - Flat-bottomed and vee-bottomed hull shapes act as planing hulls. Most small power-driven vessels, including personal watercraft (PWCs) and some small sailboats, have planing hulls, allowing them to travel more rapidly across the water.

## Length of a Vessel

A vessel's **length overall** dictates the equipment the vessel must have to comply with federal and state laws. Length overall is measured from the tip of the bow in a straight line to the stern of the vessel. Bowsprits; rudders; outboard motors and motor brackets; handles; and other fittings, attachments, and extensions are not included in the measurement.

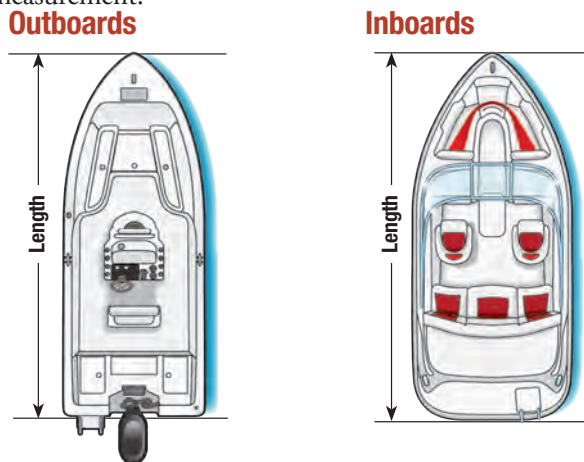

## Types of Engines and Drives

### Outboards

- An outboard is a portable, self-contained package of an engine, gear case, and propeller that is attached to the **transom** of a boat.
- A growing number of outboard engines are of four-stroke design, but many are still conventional two-stroke engines that burn oil as a lubricant along with the fuel. New-technology two-stroke outboards are direct-injection engines and burn over 75% cleaner than conventional two-stroke outboards.
- Steering of outboard boats is controlled by a **tiller** or steering wheel that swivels the entire engine to direct propeller thrust.

### Inboards

- An inboard is a four-stroke automotive engine adapted for marine use. Inboard engines are mounted inside the hull's midsection or in front of the transom.
- The engine turns a drive shaft that runs through the bottom of the hull and is attached to a propeller at the other end.
- Many personal watercraft (PWCs) have two-stroke inboard engines that burn oil as a lubricant along with the fuel. New-technology two-stroke PWC engines are direct-injection engines and burn cleaner than conventional PWC engines.
- Steering of most inboard vessels, except PWCs and jet-drive boats, is controlled by a **rudder** behind the propeller.

### Stern Drives

- Stern drives are known also as inboard/outboards (I/Os) because they combine features found on both inboard and outboard engines. Stern-drive engines are four-stroke automotive engines adapted for marine use and mounted inside the boat.
- A stern-drive engine is attached through the transom to a drive unit (also called an "outdrive") that is essentially the lower unit of an outboard. The engine turns a drive shaft that is attached to a propeller at the other end.
- Steering of stern-drive boats is controlled by the outdrive, which swivels like an outboard engine to direct propeller thrust.

## Length Classes

Some states have laws that refer to vessel lengths as "classes."

Class	Length
Class A	less than 16 feet
Class 1	16 feet to less than 26 feet
Class 2	26 feet to less than 40 feet
Class 3	40 feet to less than 65 feet

However, the U.S. Coast Guard no longer uses these designations to indicate length.

### length overall (LOA)

Length of the hull excluding any attachments

### transom

Vertical surface at the back of the hull

### tiller

Lever used to turn a rudder to steer a boat

### rudder

Steering device, usually a vertical blade attached to a post at, or near, the stern of the boat

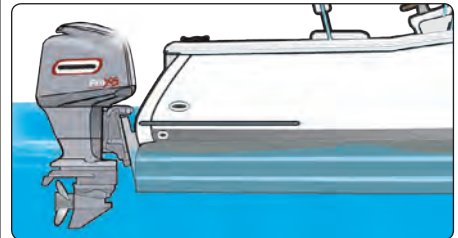

### Outboards

... have more power per pound of weight than do inboard engines.

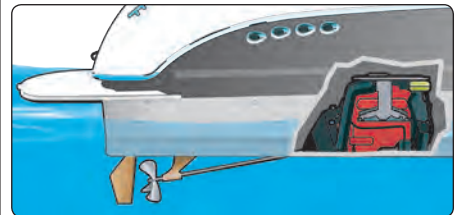

### Inboards

... have automotive engines adapted to operate in marine environments.

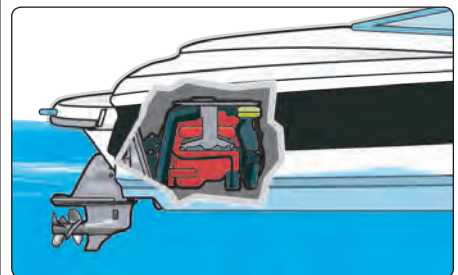

### Stern Drives

... have quieter and more fuel-efficient engines.

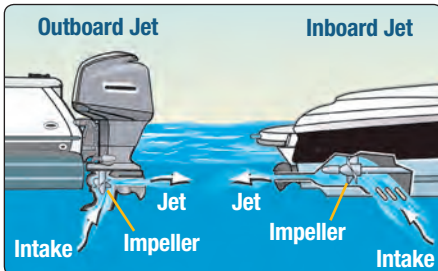

Jet drives use an engine to power a strong water pump, which sucks up water and then forces the water out the back to thrust the vessel forward.

**impeller**

Device used to pump and force water under pressure through a steering nozzle at the rear of the vessel

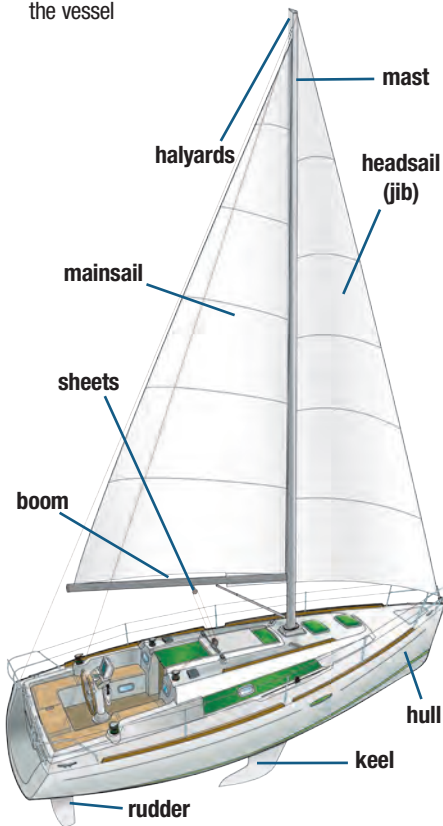

**sheets**

Lines (ropes) used to control the angle of the sails to the wind

**halyards**

Lines (ropes) used to raise and lower the sails

**Jet Drives**

- Jet drives propel a vessel by forcing a jet of water out the back of the vessel. Directing this jet of water steers the vessel.
- Personal watercraft are the most common type of vessels that use a jet drive.
- Jet drives also may power larger vessels (jet boats) and are used commonly for vessels designed for shallow water conditions. Jet boats can have inboard or outboard jet drives.

**Personal Watercraft**

- A PWC is a small vessel that uses an inboard jet drive as its primary source of propulsion and is designed to be operated by a person or persons sitting, standing, or kneeling on the vessel rather than inside the vessel. The U.S. Coast Guard includes personal watercraft in the group of inboard vessels less than 16 feet in length.
- PWCs are subject to all of the same laws and requirements of any other vessel plus a few laws specific to PWCs. See Chapter 4 for the legal requirements for PWCs.

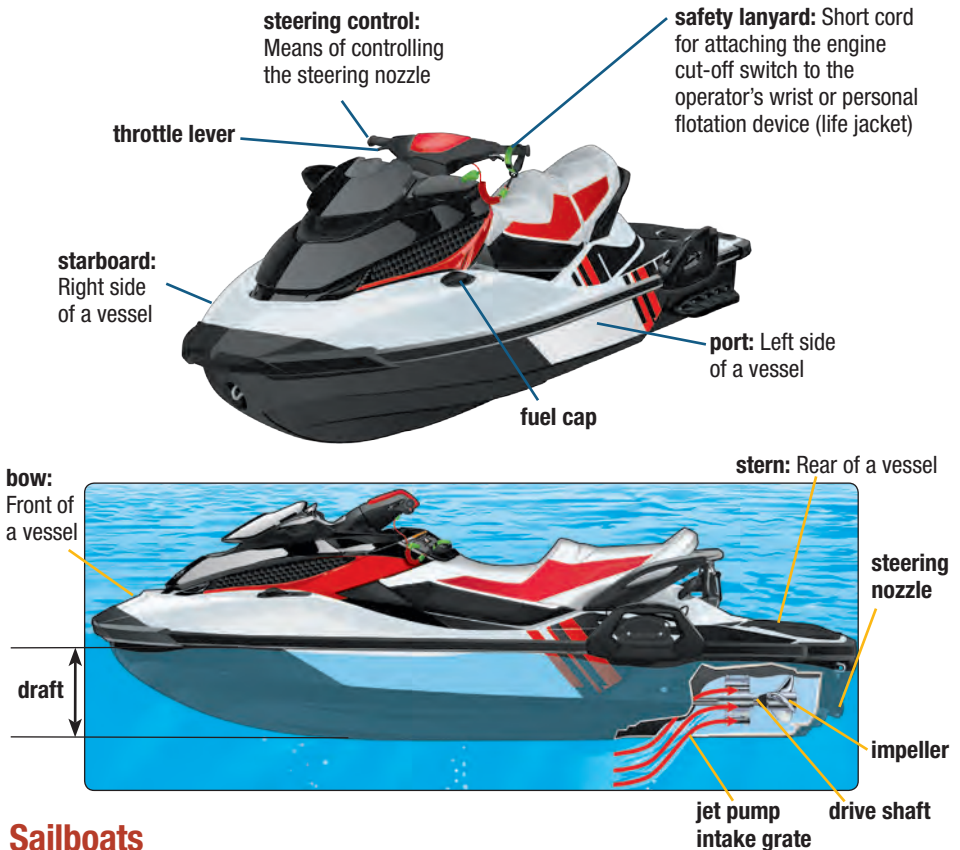

**Sailboats**

Use of the wind is one of the oldest forms of powering a vessel. Sailboats range in size and complexity, but all have basically the same four components.

- The hull carries the passengers and supports the rigging.
- The rigging includes many parts of the sailboat, such as the lines (sheets and halyards), mainsail, headsail (jib), boom, and mast.
- The keel or centerboard is attached to the bottom of the hull and keeps the boat from sliding sideways through the water.
- The rudder is used to steer the sailboat, turned by a tiller or steering wheel.



## Your Boat's Capacity

A boat operator should never take a boat on the water with too many people or too much gear on board. Boats loaded beyond their capacity will **swamp** or **capsize** more easily and will be more difficult to control.

- Look for a capacity plate near the operator's position or on the transom of the boat. This plate indicates the maximum weight capacity and/or the maximum number of people that the boat can carry safely in good weather.
  - You should not exceed *either* the stated maximum weight capacity or the maximum number of people.
  - Maximum weight is the combined weight of passengers, gear, and motors.
  - In many states, it is a violation to exceed capacity (see Chapter 4).
- Federal law requires single-hull boats less than 20 feet in length to have a capacity plate. (However, PWC and sailboat manufacturers are not required to attach a capacity plate.) Always follow the recommended capacity found in the owner's manual and on the manufacturer's warning decal. Never exceed these capacity recommendations.
- On vessels less than 20 feet in length with no capacity plate, use the following rule of thumb to calculate the number of persons (weighing 150 lbs. each, on average) the vessel can carry safely in good weather conditions.

$$\text{Number of people} = \text{vessel length (ft.)} \times \text{vessel width (ft.)} \div 15$$

For example, for a vessel 18 feet long by 6 feet wide, the number of persons is 18 times 6 (or 108) divided by 15, which equals seven 150-lb. persons (or a total person weight of 7 x 150, or 1050 lbs.).

- On outboard boats, the capacity plate also will display the recommended maximum horsepower rating of the boat. Your boat's motor should never exceed this rating.

## File a Float Plan

Before going out on a boat or PWC, it is always a good idea to tell someone where you are going and ask them to take action if you fail to return on time.

- For shorter daytime outings on the water, at a minimum you should:
  - Contact a responsible person before you go out and tell him or her where you will be boating and when you plan to return.
  - Give your contact the phone number for local authorities in case you fail to return when expected.
  - Contact this person again when you return or if you decide to extend your time out on the water.
- For extended outings on the water, leave a float plan with a relative or friend, or at least a local marina. You should leave a float plan that:
  - Describes the vessel, including its registration number, length, make, horsepower, and engine type.
  - Includes the description and license plate of the tow vehicle and trailer.
  - Gives the number of passengers, their names and addresses, and a contact in case of emergency.
  - States where you are going, the detailed route, your planned departure time, and your expected return time. Include the location of all stopping points, dates, and times.
  - Gives the phone number for local authorities in case you fail to return when expected. If boating on waters under U.S. Coast Guard jurisdiction, give the phone number of the U.S. Coast Guard.

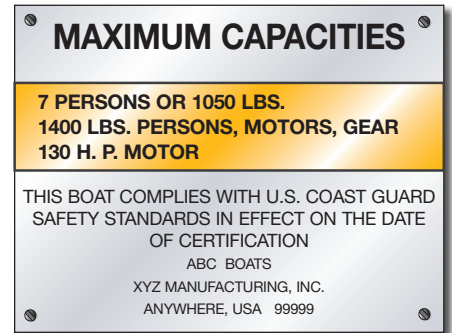

## Maximum Capacity Plate

Although federal law requires capacity plates only on boats less than 20 feet in length, the National Marine Manufacturers Association (NMMA) requires a capacity plate on all boats less than 26 feet in order to be certified by NMMA.

### swamp

To fill with water

### capsize

To turn on the side or turn completely over

## Float Plan



Get Safe. Get Certified.

### FLOAT PLAN

Complete this form before going out on your boat, and leave it with a reliable person who will notify the Coast Guard and local authorities if you do not return as scheduled. If you are delayed and it is not an emergency, inform the person with your float plan to avoid an unnecessary search.

- Name of person filing this plan: \_\_\_\_\_  
Telephone #: (\_\_\_\_) \_\_\_\_\_ - \_\_\_\_\_
- Description of boat: Registration number: \_\_\_\_\_ Type: \_\_\_\_\_ Make: \_\_\_\_\_  
Color: \_\_\_\_\_ Trim: \_\_\_\_\_ Length: \_\_\_\_\_ Name: \_\_\_\_\_
- Names of persons on board: Age: Address:  
\_\_\_\_\_  
Telephone #: (\_\_\_\_) \_\_\_\_\_ - \_\_\_\_\_  
\_\_\_\_\_  
Telephone #: (\_\_\_\_) \_\_\_\_\_ - \_\_\_\_\_  
\_\_\_\_\_  
Telephone #: (\_\_\_\_) \_\_\_\_\_ - \_\_\_\_\_  
\_\_\_\_\_  
Telephone #: (\_\_\_\_) \_\_\_\_\_ - \_\_\_\_\_  
\_\_\_\_\_  
Telephone #: (\_\_\_\_) \_\_\_\_\_ - \_\_\_\_\_
- Description of engine: Type: \_\_\_\_\_ Horsepower: \_\_\_\_\_ # of engines: \_\_\_\_\_ Fuel capacity: \_\_\_\_\_
- Survival equipment on board. Check as appropriate:  
 Life Jackets (PFDs)  Flares  Flashlight  Signal mirror  Anchor(s)  Ruff or dinghy  
 Smoke Signals  Horn  Water  Paddles  Food
- Radio  Yes  No Type: \_\_\_\_\_ Frequencies: \_\_\_\_\_ Call sign: \_\_\_\_\_
- Trip expectations  
Leaving from: \_\_\_\_\_ / \_\_\_\_\_ / \_\_\_\_\_ time \_\_\_\_\_ am \_\_\_\_\_ pm  
Departing on: \_\_\_\_\_ date \_\_\_\_\_ time \_\_\_\_\_ am \_\_\_\_\_ pm  
Going to: \_\_\_\_\_ / \_\_\_\_\_ / \_\_\_\_\_  
Returning: \_\_\_\_\_ date \_\_\_\_\_ time \_\_\_\_\_ am \_\_\_\_\_ pm
- Other pertinent information: \_\_\_\_\_
- Description of automobile: \_\_\_\_\_ Trailer license #: \_\_\_\_\_ License Plate #: \_\_\_\_\_  
Make: \_\_\_\_\_ Model: \_\_\_\_\_ Color: \_\_\_\_\_ Where parked: \_\_\_\_\_
- If not returned by: \_\_\_\_\_ / \_\_\_\_\_ / \_\_\_\_\_ time \_\_\_\_\_ am \_\_\_\_\_ pm  
Call: \_\_\_\_\_  
U.S. Coast Guard telephone #: (\_\_\_\_) \_\_\_\_\_ - \_\_\_\_\_  
Local authority: \_\_\_\_\_ Telephone #: (\_\_\_\_) \_\_\_\_\_ - \_\_\_\_\_

### Boater's Tip

Make sure you have enough fuel before casting off. Operating at two-thirds throttle instead of full throttle will conserve fuel. The following rule will help prevent running out of fuel:

One-third to get out

One-third to get back

One-third in reserve for emergencies



### bilge

Interior of the hull below the floorboards

### Remember...

Evaporating gasoline creates vapors or fumes that are heavier than air. These fumes settle to the bottom of the vessel where they could explode if enclosed areas, such as the bilge, are not ventilated properly to remove fumes.

### Fuel Selector Switch on a PWC

This switch can help you avoid becoming stranded without fuel. In order to work effectively, the switch must be set in the correct position:

- The "Off" position should be used when the PWC's engine is turned off.
- The "On" position should be used while you are underway.
- The "Reserve" position should be used if you run out of fuel while underway. This will allow you to return to shore. Don't forget to switch back to the "On" position after refueling.

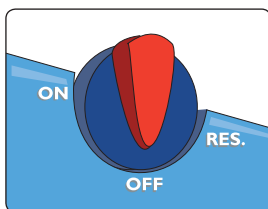

## Fuel Your Vessel...Safely

Serious accidents can occur when fueling. Never fuel at night unless it is an emergency. If you must refuel after dark, use only electric lights. To protect the water environment, try to refuel away from the water or on a commercial fueling ramp. Follow these procedures in order to fuel safely and responsibly.

### ■ Before beginning to fuel:

- Tie the boat securely to the fuel dock.
- Ask all passengers to leave the boat and go onto the dock.
- Do not allow anyone in your group or others at the fuel dock to smoke or strike a match.
- Check to see that fuel lines, connections, and fuel vents are in good condition.
- Turn off anything that might cause a spark—engines, fans, or electrical equipment.
- Shut off all fuel valves and extinguish all open flames, such as galley stoves and pilot lights.
- Close all windows, ports, doors, and other openings to prevent fumes from entering the boat.
- Remove portable fuel tanks from the boat and fill them on the dock.
- Make sure that your fire extinguisher is within reach.

### ■ While filling the fuel tank:

- Keep the nozzle of the fuel-pump hose in solid contact with the tank opening to prevent producing a static spark.
- Use caution and fill the tank slowly to avoid spilling fuel into the boat's **bilge** or into the water. Use an oil-absorbent pad to catch drips or spills.
- Never fill a tank to the brim—leave room for fuel to expand.

### ■ After fueling:

- Put the fill cap on tightly to prevent vapors from escaping.
- Wipe up any spilled fuel and properly dispose of the used paper towels or rags on shore.
- Open all windows, ports, doors, and other openings.
- If your boat is equipped with a power ventilation system (exhaust blower), turn it on for at least four minutes before starting your engine. This will help eliminate fuel vapors in the bilge.
- Before starting the engine, sniff the bilge and engine compartment for fuel vapors. Continue ventilating until you cannot smell any fuel vapors. Consider installing a gas vapor detection and alarm device.
- Start the engine and then reload your passengers.

## Fueling Issues for a PWC

Serious accidents also can occur when fueling a personal watercraft (PWC). Spilled or leaked fuel can ignite and explode, especially in an enclosed space. PWC operators should pay particular attention to these fueling guidelines.

- Check the entire fuel system for leaks and inspect fuel system connections frequently. Engine vibrations and the pounding from operating on rough water can loosen connections.
- Avoid fuel spills when fueling in or near the water.
- Do not tip the PWC in order to fill it all the way up. The tank is designed to leave space for the fuel to expand. If the tank is overfilled, the fuel may expand and spill into the water.
- After fueling, open the door of the engine compartment and sniff to check for any evidence of gas fumes. Do this before starting the engine. If you do smell gas fumes, determine the source and make repairs immediately.

## Trailer Your Vessel

### Choose the Right Trailer and Vehicle to Tow Your Vessel

- **The trailer and towing vehicle should be designed to fit your vessel.**
  - Use the size of your vessel to determine the dimensions of the trailer needed. Today, most trailerable boats are sold as a package with a trailer of the appropriate size.
  - Look at the load capacity of the trailer stated by the trailer's manufacturer. If the combined weight of your vessel and its engine is more than 90% of the recommended load capacity, buy the next larger trailer. This is because your gear (fuel, life jackets, anchors, lines, etc.) will increase the overall weight by at least 10%.
  - Check the owner's manual of your towing vehicle to ensure that your vehicle is rated to tow the combined weight of your vessel, engine, and trailer.
- **The towing hitch must be appropriate for the loaded trailer.**
  - The **coupler** on a trailer connects to a ball hitch on the towing vehicle. A frame-mounted hitch on the towing vehicle is better than a bumper-mounted hitch. If you are using a bumper-mounted hitch, do not exceed the weight rating of the bumper.
  - Make sure the size stamped on the ball hitch on the towing vehicle is the same size that is stamped on the trailer's coupler. If the ball hitch is too small, a bump in the road could cause the coupler to lift off the hitch.
  - "Tongue weight" is the amount of the loaded trailer's weight that presses down on the towing hitch. The tongue weight should be about 10% of the combined weight of the vessel and trailer ("gross trailer weight," or GTW). If the tongue weight is too light, the trailer will tend to swing from side-to-side (or "fishtail"). If the tongue weight is too heavy, the rear wheels of the towing vehicle will be weighted down, making it difficult to steer.
- **Two strong safety chains should be crisscrossed to support the trailer's coupler** if it becomes disconnected from the towing vehicle. The chains should be strong enough to hold the combined weight of the vessel, engine, and trailer.

### Before Leaving Home

- **Secure the vessel on the trailer and the gear within the vessel.**
  - Secure all gear in the vessel firmly to keep it from shifting. Arrange the gear so that its weight is balanced side-to-side and front-to-back.
  - Secure the vessel to the trailer with several tie-down straps and/or safety lines to prevent the vessel from shifting. Use extra tie-down straps in case one fails. Never trust the bow winch alone to hold your vessel onto the trailer.
  - Put the engine or drive unit in the raised position and secure it.
  - Attach the safety chains between the trailer and the towing vehicle, crisscrossing them under the trailer tongue.
- **Inspect and maintain trailering equipment.**
  - Check the pressure of all tires on the towing vehicle and the trailer. Make sure you have a spare tire in good condition for both the vehicle and the trailer.
  - Tighten the lug nuts/bolts on the wheels of both the towing vehicle and the trailer, and grease the wheel bearings.
  - Make sure that all lights and brakes on the towing vehicle and the trailer work properly.
  - Examine tie-down straps, lines, winch, safety chains, and hitch for signs of wear. Replace or adjust as necessary.



It is very important to have proper lighting on trailers, including turn signals and tail and brake lights. Also make sure you have a jack that fits properly under the trailer—most car jacks are too large to fit under a trailer.

#### coupler

The part of the trailer that attaches to the ball hitch on a towing vehicle



Crisscross the safety chains under the trailer's coupler when attaching them to the towing vehicle.



Tighten lug nuts on trailer wheels before departing.

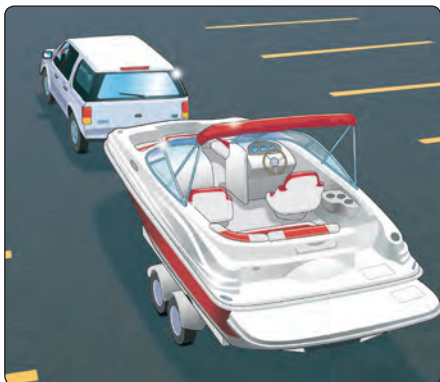

Novice boaters should practice towing, especially backing up, in an open field or empty parking lot before their initial launch and retrieval. This will give you a feel for the trailer and how it maneuvers in relation to the towing vehicle.

### Remember...

If launching or retrieving a sailboat with a raised mast, watch out for overhead wires.

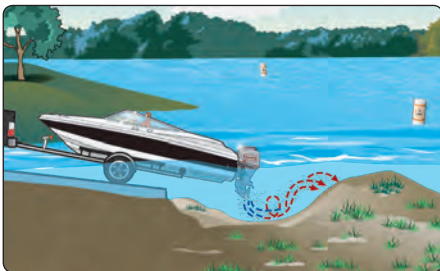

### Do Not Power Load Your Boat

Propeller wash can erode the sediment just beyond the ramp surface, creating a large hole. The eroded sediment is deposited behind the propeller, creating a mound. Trailer tires can get stuck in these holes, and boats can run aground on the mound.

## On the Road With a Trailer

### ■ Drive cautiously.

- Drive at moderate speeds and avoid sudden maneuvers.
- On long trips, pull over every hour or so to check the towing vehicle, trailer, tires, trailer coupling, and gear in the vessel.

### ■ Allow for the added length and weight of the trailer.

- Make wider turns at corners and curves.
- Allow extra time and distance for stopping and for passing other vehicles.

## Launching Your Vessel From a Trailer

### ■ Prepare to launch well away from the boat ramp so that you don't block ramp traffic.

- Transfer all equipment and supplies to the vessel.
- Disconnect trailer lights from the towing vehicle.
- Remove all tie-down straps before backing down the ramp but leave the trailer winch line securely attached to the vessel.
- Make sure the vessel's drain plug is in place.
- Tie a rope to the vessel's bow to use to control the vessel if necessary during launching.

### ■ Back the trailered vessel into the water far enough so that the lower unit of the engine can be lowered and submerged while the vessel is still on the trailer.

- As an added precaution, always set the parking brake on the towing vehicle.
- Lower the engine or outdrive, and start the engine. If your vessel is still on the trailer and you have engine trouble, you can retrieve the vessel easily.
- Once the engine is warmed up, back the trailer further into the water until the vessel floats. Undo the winch line, put the vessel's engine in reverse, and back slowly off the trailer.

## Retrieving Your Vessel

### ■ Back the trailer into the water so that approximately two-thirds of the rollers or bunks are submerged in the water. Set the parking brake of the towing vehicle, and put it in park (or first gear if you have a manual transmission).

- Move the vessel onto the trailer far enough to attach the winch line to the bow eye of the vessel. Finish pulling the vessel onto the trailer by cranking the winch. Stay out of the way of the direct line of the winch cable in case it snaps or you lose control of the winch. Do not load a vessel using engine power because this can cause damage (see diagram on left).
- Shut off the engine, and raise the engine or outdrive.
- Pull the vessel out of the water.

### ■ Prepare for the drive home well away from the boat ramp so that you don't block ramp traffic.

- While on land at the ramp area, remove and dispose of all weeds from the vessel and trailer, remove the drain plug to release bilge water, and drain any live wells. This will help prevent the spread of aquatic nuisance plants and animals (see Chapter 4).
- Secure the vessel on the trailer and the gear within the vessel, following the same instructions listed on the previous page under "Before Leaving Home."

## Courtesy on the Boat Ramp

Boat ramp traffic jams can be prevented if everyone practices common courtesy at the ramp. Be sure you observe these simple courtesies.

- Prepare your vessel for launching or for the drive home well away from the ramp.
- Use at least two experienced people to launch and retrieve the vessel—one to drive the towing vehicle and one to operate the vessel.
- Never block a ramp with an unattended vessel or vehicle. Move the vessel away from the launch lane immediately after removing it from the trailer. Return briefly to pick up the vehicle driver once he or she has parked the vehicle and is back at the ramp.
- When retrieving, do not pull your vessel into a launch lane until the towing vehicle is at the ramp. The line is formed by vehicles with trailers, not by vessels in the water. Drop off the vehicle driver, and wait offshore and clear of the ramp until he or she arrives with the trailer.

## Vessel Maintenance

Keeping your vessel well-maintained will extend its life and give you and your family many more years of enjoyment.

- Examine the interior and exterior of the hull when it is out of the water.
  - Check for oxidation, a common problem on aluminum hulls, that appears as white powder spots. Use fine sandpaper on oxidized areas until spots are replaced by bright shiny metal.
  - To protect the environment, use only environmentally safe, non-phosphate detergents to remove oil and algae from fiberglass hulls. Avoid abrasive materials, which can remove the shiny top layer (gel coat). Patch holes immediately with a fiberglass patching compound.
  - Check through-hull fittings to make sure they are not cracked or leaking.
  - Remove all puddles from the interior before and after every outing.
- Store vessels in a dry area out of the sun. If you must store the vessel for a long period of time, place the trailer on blocks to preserve the tires. Keep the vessel covered, leaving an opening to circulate air. Hang canoes upside down.
- Clean all lines (ropes). Dirt and sand cause deterioration. Keep lines out of the sun when not in use, and replace weakened or fraying lines.
- Clean sails with a soft brush. Examine them for small tears or open seams that can be repaired by taping or sewing.
- Refer to the owner's manual for a maintenance schedule.



Use at least two experienced people to launch and retrieve your vessel—one to drive the towing vehicle and one to operate the vessel. If launching and retrieving by yourself, it is recommended to place wheel chocks behind the wheels of the towing vehicle.

## Engine Maintenance

Engine maintenance is important. Follow a regular maintenance program.

- ✓ Keep your engine clean and tuned properly. Refer to your owner's manual for a maintenance schedule.
- ✓ Check the oil and fluid levels before every outing. Change the oil according to the owner's manual. As the engine ages, increase the frequency of oil changes. Clean oil extends engine life.
- ✓ Tighten battery connections. Clean battery terminals by disconnecting the terminals and removing corrosion with a wire brush. If the battery is weak when you start the engine, recharge it.
- ✓ Inspect the engine for anything that shows signs of wear or requires tightening, such as hoses, belts, and bolts. Make sure everything is fitted properly, including the engine cover.
- ✓ Never use automotive electrical parts. Use marine parts only. Use of automotive parts rather than sealed marine parts (such as alternators, starters, fuel pumps, and other electrical parts) could cause a spark that could ignite a fire.

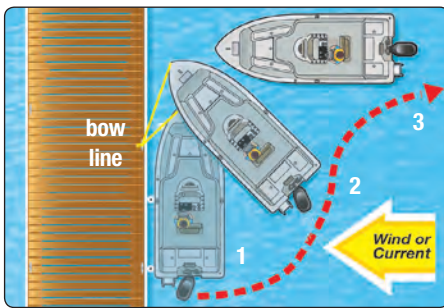

**Casting Off** Wind direction toward dock

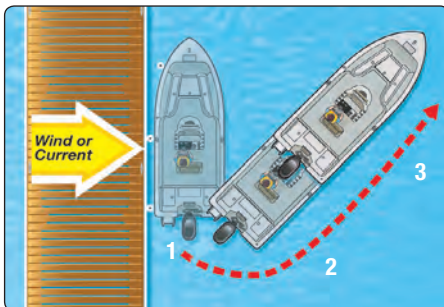

**Casting Off** Wind direction away from dock

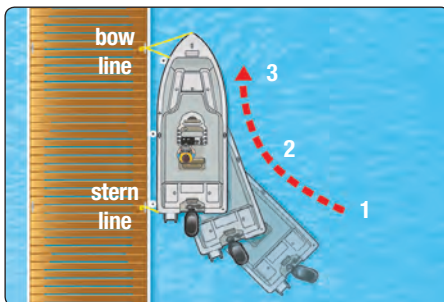

**Docking** No wind or current

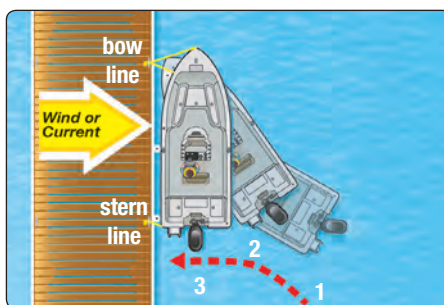

**Docking** Wind direction away from dock

### Remember...

These casting off and docking procedures are for small, single-engine boats. Procedures for large boats, sailboats, or boats with twin engines will vary.

## Casting Off

### ■ Before casting off:

- Keep your boat tied to the dock while you warm up the engine.
- Make sure everyone on board is seated and wearing a life jacket.
- Check that the engine is running properly and the departure area is clear of traffic. Then begin to cast off.

### ■ If there is no wind or current:

1. Cast off the bow and stern lines.
2. Shift to forward and slowly move forward, gradually turning your boat away from the dock.

### ■ If the wind or current direction is toward the dock:

1. Cast off the stern line. Move and secure the bow line to a mid-boat position on the dock. Make sure fenders are in place on the bow.
2. Put the boat into forward gear briefly, and turn the steering wheel hard toward the dock. Increase speed slowly until the stern is well clear of the dock.
3. Cast off the bow line. Back out slowly until you have room to shift into forward and turn away from the dock.

### ■ If the wind or current direction is away from the dock:

1. Cast off the bow and stern lines.
2. Use an oar or boat hook to keep the boat clear of the dock. Let the wind or current carry the boat away from the dock.
3. Once there is sufficient clearance, shift into forward gear and slowly leave the area.

## Docking

### ■ Before docking:

- Reduce speed to the minimum required to maintain steerage. Use reverse gear to bring the boat to a stop well away from the dock.
- Determine the wind and/or current direction while stopped by observing which way your boat drifts. If possible, make your approach into the wind or current, whichever is stronger. This will give you more control.
- Have bow and stern lines ready, and put boat fenders in place. Never plan to stop a moving boat with your arms or legs.
- When the area is clear of traffic, continue your approach.

### ■ If there is no wind or current:

1. Approach the dock slowly at a narrow angle (about 20 degrees).
2. When close enough, have a passenger step on shore and secure the bow line.
3. Swing the stern in with a line or boat hook, and secure it.

### ■ If the wind or current direction is toward the dock:

1. Approach slowly, parallel to the dock.
2. Let the wind or current carry your boat to the dock. Shift into gear briefly if you need to adjust position.
3. Secure the bow and stern lines.

### ■ If the wind or current direction is away from the dock:

1. Approach the dock slowly at a sharp angle (about 40 degrees).
2. Use reverse to stop when close to the dock. Secure the bow line.
3. Put the boat in forward gear briefly, and slowly turn the steering wheel hard away from the dock—this will swing in the stern. Secure the stern line.

## Navigation Rules...Traffic Laws of the Waterways

Collisions can be prevented easily if every vessel operator fulfills three major responsibilities.

### 1. Practice good seamanship.

It is the responsibility of every boat or PWC operator to take all necessary action to avoid a collision, taking into account the weather, vessel traffic, and limits of other vessels. Such action should be taken in ample time to avoid a collision and at a safe distance from other vessels.

### 2. Keep a proper lookout.

Failing to keep a sharp lookout is the most common cause of collisions. Every operator must keep a proper lookout, using both sight and hearing, at all times. Watch and listen for other vessels, radio communications, navigational hazards, and others involved in water activities.

### 3. Maintain a safe speed.

Safe speed is the speed that ensures you will have ample time to avoid a collision and can stop within an appropriate distance. Safe speed will vary depending on conditions such as wind, water conditions, navigational hazards, visibility, surrounding vessel traffic density, and the maneuverability of your boat or PWC. Always reduce speed and navigate with extreme caution at night and when visibility is restricted.

## Encountering Other Vessels

There are rules that every operator must follow when encountering other vessels.

- Two terms help explain these rules.
  - **Give-way vessel:** The vessel that is required to take early and substantial action to keep well away from other vessels by stopping, slowing down, or changing course. Avoid crossing in front of other vessels. Any change in course and/or speed should be large enough to be readily apparent to another vessel. (A series of small changes should be avoided.)
  - **Stand-on vessel:** The vessel that must maintain its course and speed unless it becomes apparent that the give-way vessel is not taking appropriate action. If you must take action, do not turn toward the give-way vessel or cross in front of it.
- The action a vessel operator should take when encountering another vessel depends on the answers to two questions.
  - **How are the two vessels propelled?**
    - Two power-driven vessels
    - Two sailing vessels
    - A power-driven vessel and a sailing vessel
  - **How are the two vessels approaching one another?**
    - *Meeting head-on:* A vessel operator sees another vessel ahead or nearly ahead
    - *Paths that cross:* Two vessels are on crossing paths so as to involve risk of collision
    - *Overtaking:* A vessel is coming upon another vessel from behind or nearly behind the other vessel
- The rules that follow cover most of the situations you will encounter as a recreational boater.
  - Note that the illustrations are not drawn to scale. The boats are shown closer to each other than they should be when actually encountering another vessel on the water.
  - Be aware that there are exceptions to the rules. For example, if you approach a vessel that has less maneuverability than your vessel, the other vessel will usually be the stand-on vessel (see sidebar on page 12, "Responsibilities Between Vessels").

## Additional Information

The navigation rules contained in this course summarize the basic navigation responsibilities for a boat operator on inland waterways. Additional and more in-depth rules apply to various types of waterways, such as International Waters and Western Rivers, and to operation regarding commercial vessels and other watercraft. It is the responsibility of an operator to know and follow all the navigation rules. For a complete listing of the navigation rules, refer to the U.S. Coast Guard publication *Navigation Rules* (COMDTINST 16672.2 Series) that can be purchased from the U.S. Government Bookstore.

Or you can view the rules online at:

<http://www.navcen.uscg.gov/?pageName=navRulesContent>

For state-specific navigation requirements, refer to the laws of the state where you intend to boat.



## Navigation Rules: Definitions

For the purpose of the U.S. Coast Guard's navigation rules, the following definitions apply.

- **Vessel:** Every kind of watercraft capable of being used as a means of transportation on water, including seaplanes
- **Power-driven vessel:** Any vessel propelled by machinery, including a sailboat using an engine
- **Sailing vessel:** Any vessel under sail and with no engine in use
- **Underway:** Not anchored, tied to shore, or aground
- **Risk of collision:** Any situation where an approaching vessel continues on a collision course (the bearing of the approaching vessel does not change), or anytime you are approaching a very large vessel

### Remember...

Every operator is responsible for avoiding a collision. In complying with the navigation rules, operators must consider all dangers of navigation; risk of collisions; and any special conditions, including the limitations of the vessels involved. These considerations may make a departure from the navigation rules necessary to avoid immediate danger.

### Responsibilities Between Vessels

**If operating a power-driven vessel, you must give way to:**

- Any vessel not under command, such as an anchored or disabled vessel
- Any vessel restricted in its ability to maneuver, such as a vessel towing, laying cable, or picking up navigation markers, or a vessel constrained by its draft, such as a large ship in a channel
- A vessel engaged in commercial fishing
- A sailing vessel unless it is overtaking

**If operating a sailing vessel, you must give way to:**

- Any vessel not under command
- Any vessel restricted in its ability to maneuver
- A vessel engaged in commercial fishing

### windward

Direction from which the wind is blowing, or upwind. Windward vessel refers to the vessel that is upwind of the other

### leeward

Direction toward which the wind is blowing, or downwind. Leeward vessel refers to the vessel that is downwind of the other

### Rendering Assistance

The navigation rules also require operators to stop and render assistance to a vessel in distress unless doing so would endanger their own vessel or passengers.

## Power-Driven Vessel Encountering Power-Driven Vessel

**Meeting Head-On**

- Neither vessel is the stand-on vessel.
- Both vessels should turn to starboard (the right) and use sound signals to share their plans.

**Paths That Cross**

- If the other vessel is on your port (left), stand on.
- If the other vessel is on your starboard (right), give way and use sound signals to let the other boater know your plans.

**Overtaking**

- If you are overtaking, give way. Use sound signals to let the other boater know which direction you are planning to go.
- If you are being overtaken, stand on.

## Sailing Vessel Encountering Sailing Vessel

If a sailing vessel with the wind on its port (left) side cannot determine whether a windward sailing vessel has the wind on the left or the right, it should give way to the windward vessel.

**Wind on Same Side**

- If you are the windward vessel, give way and signal to the other boater.
- If you are the leeward vessel, stand on.

**Wind on Different Sides**

- If the wind is on your port (left) side, give way and use sound signals.
- If the wind is on your starboard (right), stand on.



## Power-Driven Vessel Encountering Sailing Vessel

**TOOT** signals intent

Give way!

**TOOT** signals agreement

**Meeting Head-On**

- If you are the power-driven vessel, give way and signal the other boater.
- If you are the sailing vessel, stand on.

Give way!

**TOOT** signals intent to go right

**TOOT TOOT** signals intent to go left

Give way!

**Paths That Cross**

- If you are the power-driven vessel, give way and signal the other boater.
- If you are the sailing vessel, stand on.

Give way!

**TOOT TOOT** signals intent to pass on the give-way vessel's starboard (right) side

**TOOT** signals intent to pass on the give-way vessel's port (left) side

**Overtaking**

- If you are overtaking, give way and use sound signals.
- If you are being overtaken, stand on.

Give way!

**TOOT TOOT** signals intent to pass on the give-way vessel's starboard (right) side

**TOOT** signals intent to pass on the give-way vessel's port (left) side

### Operating During Restricted Visibility

All operators should navigate with extreme caution if visibility is restricted. The following applies to vessels not in sight of one another.

- Every vessel must proceed at a safe speed given the conditions of restricted visibility. A power-driven vessel must have its engines ready to maneuver immediately.
- Unless a risk of collision does not exist, an operator who hears the fog signal of another vessel ahead, is in a close-quarters situation with another vessel ahead, or detects the presence of another vessel by radar must reduce speed to the minimum at which the vessel can be kept on course. If necessary, the operator should reduce speed to idle speed.

### Precautions at Night

- ✓ Make sure your navigation lights are working correctly, and carry extra bulbs.
- ✓ Use an all-round white light whenever the vessel is at anchor.
- ✓ Reduce speed and proceed with caution. Never be in a hurry.
- ✓ Be especially alert for everything in front of you. Avoid traveling alone at night; extra eyes can help you navigate.
- ✓ Stop if visibility is severely restricted, and use your sound signals to alert others in the area.

### Navigation Lights

Navigation lights help you and other boaters determine which is the give-way vessel when encountering each other at night. These lights must be displayed from sunset to sunrise and during periods of restricted visibility, such as fog. Chapter 4 discusses the light requirements for different types of vessels. There are four common navigation lights.

- **Sidelights:** These red and green lights are called sidelights (also called combination lights) because they are visible to another vessel approaching from the side or head-on. The red light indicates a vessel's port (left) side; the green indicates a vessel's starboard (right) side.
- **Sternlight:** This white light is seen only from behind or nearly behind the vessel.
- **Masthead Light:** This white light shines forward and to both sides and is required on all power-driven vessels. (On power-driven vessels less than 39.4 feet in length, the masthead light and sternlight may be combined into an all-round white light; power-driven vessels 39.4 feet in length or longer must have a separate masthead light.) A masthead light must be displayed by all vessels when under engine power. The absence of this light indicates a sailing vessel because sailboats under sail display only sidelights and a sternlight.
- **All-Round White Light:** On power-driven vessels less than 39.4 feet in length, this light may be used to combine a masthead light and sternlight into a single white light that can be seen by other vessels from any direction. This light serves as an anchor light when sidelights are extinguished.

### Typical Recreation Vessels' Navigation Lights

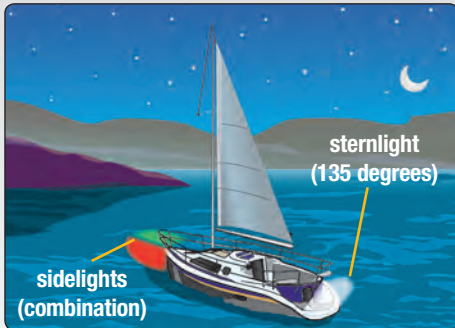

Navigation lights of a sailing vessel



Navigation lights of a power-driven vessel with an all-round white light and combination sidelights placed on the bow

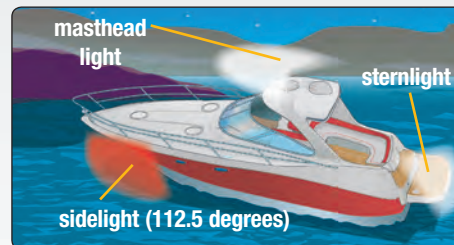

Navigation lights of a power-driven vessel with masthead light, sternlight, and separate sidelights

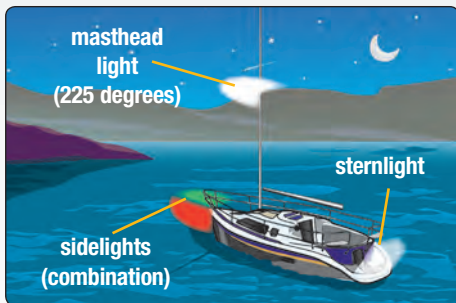

Navigation lights of a sailboat **under power**



All-round white light indicating a vessel anchored away from the dock

## Night Navigation

Night navigation presents additional challenges. You should always operate at a slower speed at night and be on sharp lookout for the lights of other vessels. The lights displayed by other vessels will help you determine whether they are operating under power or sail, and their direction of travel. Once you've determined this, you apply the same navigation rules used in the daytime. However, never assume that the lights of other vessels are working properly. Allow plenty of time and distance to give way if needed, even if the lights indicate you are the stand-on vessel.

### Power-Driven Vessel Encountering Other Vessels at Night

When you see a red, a green, and a white light, you are approaching another power-driven vessel head-on and both vessels must give way.



When you see a green and a white light, you are the stand-on vessel. You should remain alert, however, in case the other vessel operator does not see you or does not know navigation rules.

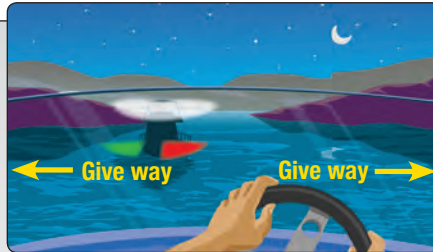
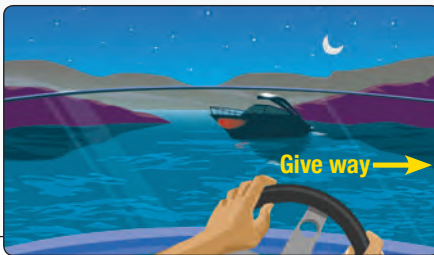

When you see only a white light, you are overtaking another vessel or it is anchored. It is the stand-on vessel, whether underway or anchored. You may go around it on either side.



When you see a red and a white light, you must give way to the other vessel! Slow down and allow the vessel to pass, or you may turn to the right and pass behind the other vessel.

### Encountering a Sailing Vessel at Night



When you see **only a green light**

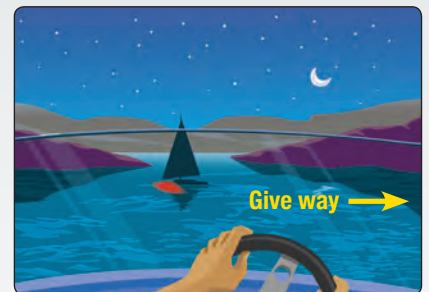

**or only a red light**, you may be approaching a sailing vessel and you must give way. A sailing vessel is always the stand-on vessel except when it is overtaking.

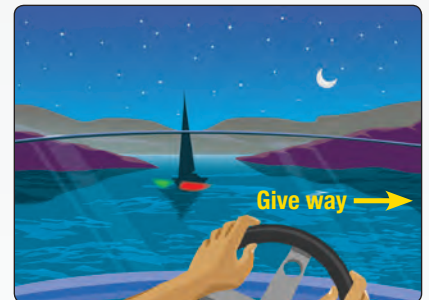

When you see a **red and a green light but no white light**, you are approaching a sailing vessel head-on and you must give way.

### Towing Lights

When commercial vessels are towing or pushing a barge, they display one or more yellow lights in place of a sternlight. There may be an unlit space of several hundred yards between the lights displayed on the bow and stern of the composite formed by the commercial vessel and its barge(s). Learn to recognize commercial vessel lights if boating on rivers, harbors, or coastal waters.

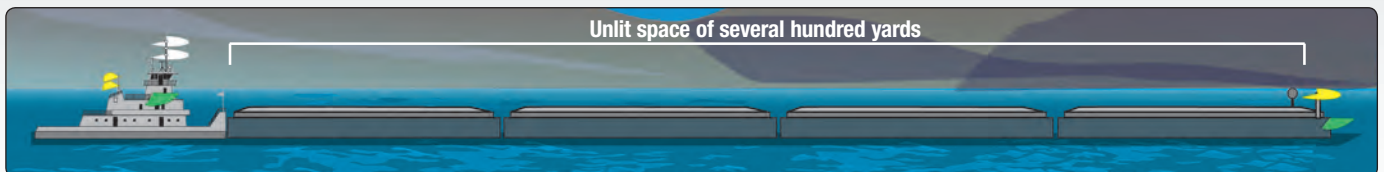

## Sound Signals for Encountering Situations

Navigation rules include the use of sound signals to communicate with other boaters.

- Toot (one short blast) tells other boaters, “I intend to pass you on my port (left) side.”

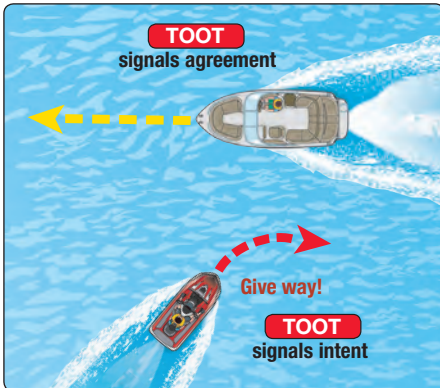

- Toot Toot (two short blasts) tells other boaters, “I intend to pass you on my starboard (right) side.”

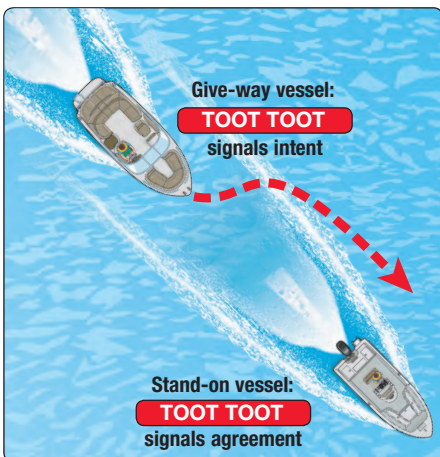

The other vessel will sound the same signal if in agreement with the proposed maneuver.

### Boater's Tip

In most circumstances, you can use this phrase as a reminder of the correct course when returning from open waters or heading upstream: “Red Right Returning”



## Sound Signals

Sound signals used on the waterways are like the turn light indicators used to signal intentions on the highways. Sound signals are also like an automobile's horn used to let other drivers know you are near or to alert them of danger. Chapter 4 discusses the sound signal equipment requirements for different types of vessels. All boaters should know proper sound signals, especially those boaters operating near commercial vessel traffic.

- **Sound signals are composed of short and prolonged blasts** and must be audible for at least one-half mile:
  - *Short blast*—about one second in duration
  - *Prolonged blast*—4–6 seconds in duration
- **Sound signals can communicate a change in direction to other boaters.**
  - *One short blast* tells other boaters, “I intend to pass you on my port (left) side.”
  - *Two short blasts* tell other boaters, “I intend to pass you on my starboard (right) side.”
  - *Three short blasts* tell other boaters, “I am operating astern propulsion.” For some vessels, this tells other boaters, “I am backing up.”
- **Sound signals let other boaters know where you are located** during periods of restricted visibility, such as extreme fog. If you hear the fog signal of a vessel you cannot see, slow to a minimum speed until you are sure there is not a risk of collision.
  - *One prolonged blast at intervals of not more than two minutes* is the signal used by power-driven vessels when underway.
  - *One prolonged blast plus two short blasts at intervals of not more than two minutes* is the signal used by sailing vessels.
- **Sound signals are used to warn other boaters or alert them to danger.**
  - *One prolonged blast* is a warning signal (for example, used when coming around a blind bend or leaving the dock).
  - *Five (or more) short, rapid blasts* are used to signal danger or to signal that you do not understand or you disagree with the other boater's intentions.

## U.S. Aids to Navigation System (ATON)

Buoys and markers are the “traffic signals” that guide vessel operators safely along some waterways. They also identify dangerous or controlled areas and give directions and information. As a recreational boat or PWC operator, you will need to know the lateral navigation markers and non-lateral markers of the U.S. Aids to Navigation System.

### Lateral Markers

These navigation aids mark the edges of safe water areas; for example, directing travel within a channel. The markers use a combination of colors and numbers, which may appear on either buoys or permanently placed markers.

### Colors and Numbers

The colors and numbers have the same meaning regardless of the kind of buoy or marker on which they appear.

- **Red Colors, Red Lights, and Even Numbers:** These mark the edge of the channel on your starboard (right) side as you enter from the open sea or head upstream. Numbers usually will increase consecutively as you return from the open sea or head upstream.

- **Green Colors, Green Lights, and Odd Numbers:** These mark the edge of the channel on your port (left) side as you enter from the open sea or head upstream. Numbers usually will increase consecutively as you return from the open sea or head upstream.
- **Red and Green Colors and/or Lights:** These are placed at the junction of two channels to indicate the preferred (primary) channel when a channel splits. If green is on top, the preferred channel is to the right. If red is on top, the preferred channel is to the left. These also are sometimes referred to as “junction buoys.”

### Shapes

- **Nun Buoys:** These cone-shaped buoys are always marked with red markings and even numbers. They mark the edge of the channel on your starboard (right) side when entering from the open sea or heading upstream.
- **Can Buoys:** These cylindrical-shaped buoys are always marked with green markings and odd numbers. They mark the edge of the channel on your port (left) side when entering from the open sea or heading upstream.

### Other Kinds of Buoys and Markers

- **Lighted Buoys:** These buoys use the lateral marker shapes, colors, and numbers discussed above. In addition, they have a matching colored light.
- **Daymarks:** These are permanently placed signs attached to structures, such as posts, in the water. Common daymarks are red triangles (equivalent to nuns) and green squares (equivalent to cans). These may be lighted also.

### Variations on the U.S. Aids to Navigation System

Some waters of the United States have slight variations on the lateral navigation markers. You should be aware of these if you boat on these waters.

#### Intracoastal Waterway (ICW)

The Intracoastal Waterway (ICW) is a chain of local channels linked together to provide an inland passage along the Atlantic and Gulf of Mexico coasts.

- Channels that are part of the ICW are identified by yellow symbols on channel buoys and markers. Buoys and markers that bear these yellow symbols are serving a dual purpose—they are navigational aids for both the U.S. Aids to Navigation System and the Intracoastal Waterway.
- When following the Intracoastal Waterway in a clockwise direction starting from New Jersey and heading to Brownsville, Texas, these rules apply.
  - Any marker displaying a yellow triangle should be passed by keeping it on the starboard (right) side of the vessel.
  - Any marker displaying a yellow square should be passed by keeping it on the port (left) side of the vessel.
- These rules are true regardless of the shape or color of the channel marker or buoy on which the ICW symbols are displayed. When you are following the Intracoastal Waterway, the yellow triangles and squares should be used as guides, rather than the colors and shapes of the lateral navigation markers on which they appear.

### Examples of Lateral Markers

#### Buoys



**Can**  
Green With Odd  
Numbers



**Nun**  
Red With  
Even Numbers

#### Lighted Buoys



**Green Colors  
and Lights**



**Red Colors  
and Lights**

#### Daymarks (on a Fixed Post or Piling)



**Reflective Green,  
Odd Numbers**



**Reflective Red,  
Even Numbers**

#### ICW Symbols on Daymarks



Intracoastal Waterway (ICW) symbols are most commonly found on daymarks.

### Western Rivers System Marker



On the Western Rivers System, this daymark indicates the right side of the channel as a boater heads upstream. The number below the marker indicates that the boater is 73.5 miles from the river's mouth.

### Other Non-Lateral Markers

**Safe Water Marker:** These are white with red vertical stripes and indicate unobstructed water on all sides. They mark mid-channels or fairways and may be passed on either side.

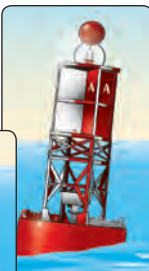
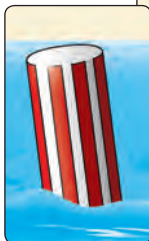

**Inland Waters Obstruction Marker:** These are white with black vertical stripes and indicate an obstruction to navigation. You should not pass between these buoys and the nearest shore.



**Mooring Buoy:** These are white with a blue horizontal band. They usually are placed in marinas and other areas where vessels are allowed to anchor. These are the only buoys you may tie up to legally.

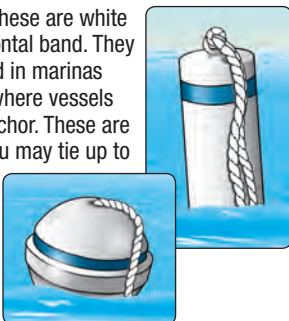

### Western Rivers System

This system of markers is used on the Mississippi River and its tributaries above Baton Rouge, Louisiana, and on some other rivers that flow toward the Gulf of Mexico. The major difference from the U.S. Aids to Navigation System lateral markers shown on the previous page is that navigation markers on the Western Rivers System are not numbered. Numbers displayed below daymarks along this system are not associated with the right or left side of the channel; these numbers indicate the distance from the river's mouth (except on the Ohio River, where the numbers indicate the distance from the headwaters).

### Non-Lateral Markers

Non-lateral markers are navigation aids that give information other than the edges of safe water areas. The most common are regulatory markers that are white and use orange markings and black lettering. These markers are found on lakes and rivers and are used to:

- Give directions and information.
- Warn of hazards and obstructions.
- Mark controlled areas.
- Mark exclusion (closed) areas.



#### Information

Squares provide information, such as places to find food, supplies, and repairs; and they also give directions, distances, and other non-regulatory information.



#### Danger Area

Diamonds warn of dangers such as rocks, shoals, construction, dams, or stumps. Always proceed with caution and keep a safe distance. Never assume that every hazard will be marked by a buoy.



#### Controlled Area

Circles indicate a controlled area such as no wake, idle speed, speed limit, or ski zone.



#### Exclusion Area

Crossed diamonds indicate areas off-limits to all vessels, such as swimming areas, dams, and spillways.

## Anchoring

Even though anchors are used most often by recreational boaters to “park” their boat while swimming or fishing, anchors are also critical equipment in times of emergency. Anchoring may be a safety measure if your boat becomes disabled.

### ■ Choose an anchor that fits your boat and the boating conditions.

- The plow-style anchor is good for most boats and gets its holding power by plowing into bottom sediments.
- The fluke-style anchor (commonly referred to as Danforth) is similar to the plow style but is more lightweight. It is also good for most boats and gets its holding power from its pointed flukes, which dig into bottom sediments.
- The mushroom anchor gets its holding power by sinking into bottom sediments. It should not be used to anchor boats larger than a small canoe, rowboat, small sailboat, or inflatable boat since the holding power is weak. You should never depend on a mushroom anchor to hold your boat in rough water or weather.

### ■ Prepare your anchor before setting out.

- Attach 7–8 feet of galvanized chain to the anchor. The chain aids in setting the anchor by lowering the angle of the pull as the chain sinks and lies on the bottom. It also will help prevent abrasion of the anchor line from sand or rock on the bottom. Most anchors grip by digging into the bottom when the line is pulled horizontally. Any upward pull may break the anchor loose.
- Be sure the anchor line is strong and long enough to anchor your boat. A good rule of thumb is that the length of the line should be at least seven to ten times the depth of the water where you are setting anchor.
- Since an anchor can be a safety device in an emergency situation, store the anchor and its lines in an accessible area. If the engine breaks down, you may need to anchor quickly to avoid drifting aground.

### ■ Follow these steps to anchor your boat.

1. Select an area to anchor with plenty of room. Ideally, it should be a well-protected area with adequate water depth and a sandy or muddy bottom.
2. Head slowly into the wind or current to a position upwind or upcurrent of where you actually want to end up.
3. When you are at that position, stop the boat and slowly lower the anchor over the bow to the bottom. ***Never anchor from the stern as this can cause the boat to swamp.*** The square stern may be hit by waves, and water will splash into the boat. The motor’s weight will add to this problem.
4. Slowly back the boat away downwind or downcurrent. Let out about seven to ten times as much anchor line as the depth of the water, depending on the wind strength and wave size. Tie off the line around a bow cleat, and pull on the anchor line to make sure the anchor is set.
5. After anchoring, take visual sightings of onshore objects or buoys in the water to help you know where your boat is positioned. While at anchor, recheck these sightings frequently to make sure the anchor is not dragging.
6. Periodically check connecting knots on your anchor line. When possible, use splices instead of knots. Knots weaken a line more than splices.

### ■ Follow these steps to retrieve your anchor.

1. Move the boat directly over the anchor while pulling in the line. Pulling the anchor straight up should break it free.
2. If the anchor is stuck, turn your boat in a large circle while keeping the anchor line pulled tight.
3. When the anchor breaks loose, stop the boat and retrieve the anchor. Never drag the anchor behind the boat.

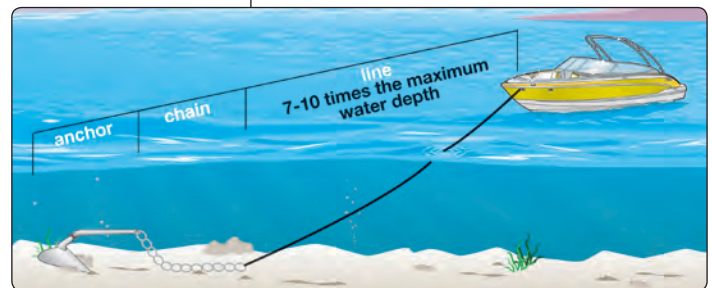
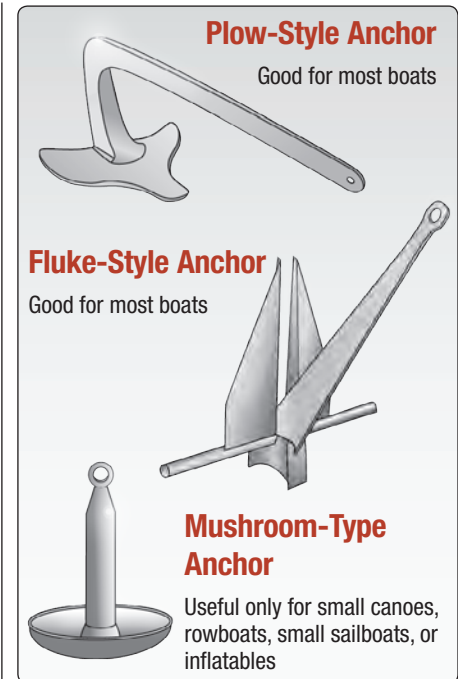

You should never anchor in, or otherwise obstruct passage through, channels or areas such as launching ramps or any other high-traffic areas.

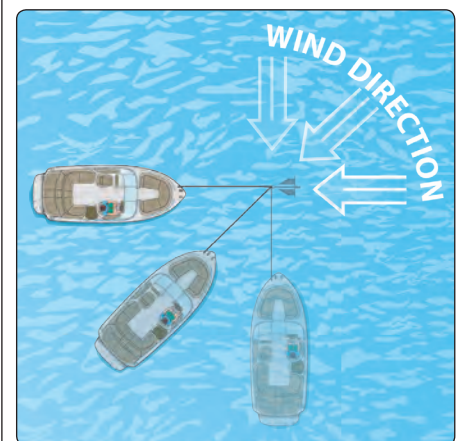

Be aware that the boat will swing downwind or downcurrent from the anchor. Allow “swing room” for any change in wind or current!

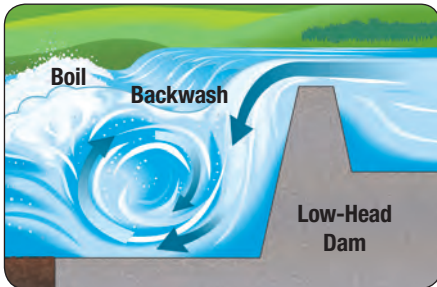

Low-head dams pose a serious danger to vessel operators. Surface currents below low-head dams can suck vessels toward the face of the dam. Currents above low-head dams can sweep vessels over the dam. The recirculating currents and turbulent waters below these dams can swamp vessels and drown boaters.

## Dams, Locks, and Bridges

Boat and PWC operators may encounter physical structures such as dams, locks, and bridges. You need to be extra cautious in these situations.

### Dams

Dams pose dangers both above and below the dams.

- **The low-head dam** is the most dangerous type of dam and has been named the “drowning machine.” They may not be easily spotted because the top of a low-head dam can be several feet below the water’s surface. Because of their small size and drop, low-head dams do not appear to be dangerous. However, water going over a low-head dam creates a strong recirculating current or backroller (sometimes referred to as the “boil”) at the base of the dam. Even on small rivers, the force of the backroller can trap your vessel against the face of the dam and pull you under the water—even while wearing your personal flotation device (life jacket). Be aware that on large rivers or during high water the backroller or boil may be located more than 100 feet downstream of the dam. *Avoid low-head dams.*
- **Large-structure dams** are more easily spotted because of their powerhouses and spillways. They can be dangerous to boaters and swimmers both below and above the dam. These areas are usually off-limits. Obey all warning signs and signals.

### Locks

By learning how to use locks, you will have a host of new opportunities for pleasure boating on the rivers of North America. Lock attendants are present at most locks to help you through safely.

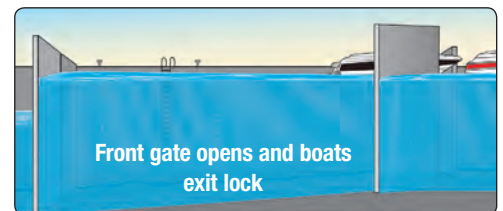
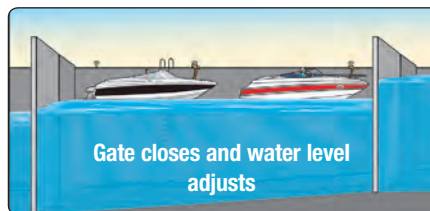
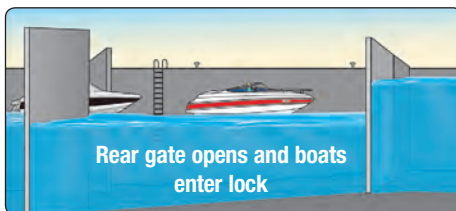

### Traffic Signal Lights at Locks



Flashing red light means stay well clear of the lock and do not enter. Allow plenty of room for boats to exit the lock.

Flashing amber light means approach the lock at a safe speed and under full control.

Flashing green light means enter the lock.

- A series of dams on a river help maintain enough water depth to allow river traffic to operate year-round. As a result of a dam, there will be two levels of water at the dam site—one level above the dam and a different one below. Locks safely transport boats from one water level to another, like an elevator.
- **When approaching the lock:**
  - Be aware that commercial traffic always has priority over recreational boats.
  - Wait at least 400 feet away from the lock for the signal to enter the lock.
  - Alert the lock attendant that you wish to go through the lock. You can sound one prolonged blast followed by one short blast of your boat’s sound-producing device. You also may contact the lock attendant using your VHF marine radio on Channel 13, but never interrupt commercial communication.
  - Enter the lock only after you’ve been signaled to enter by the lock’s traffic lights or by the lock attendant. Otherwise, stay well clear of the lock.
- **When using locks, boaters should:**
  - Have fenders and at least 100 feet of rope to use in securing your boat inside the lock.
  - Follow the lock attendant’s instructions and proceed slowly.
  - Avoid passing another boat when inside the lock, unless directed to do so by the lock attendant.
  - Wait for the lock attendant’s signal to exit the lock.



## Bridges

- Most states have laws requiring that you pass under bridges at a slow speed. You should always reduce your speed and proceed with caution near any bridge or man-made structure that decreases visibility and passage.
- Many bridges are high enough to allow normal boat passage. However, some bridges provide only low clearance during normal conditions or periods of high water.
- Many drawbridges open and close when a boat arrives. To request passage, contact the bridge operator using sound signals or a VHF marine radio.
- Be aware that debris can collect around pilings of bridges and create dangerous obstructions.

## Changing Water Levels

Fluctuating water levels can cause special hazards for boaters. Water levels can change rapidly due to tides, flooding rivers, or water released through dams. Any of these conditions can cause boats to run aground in areas where navigation may have been safe earlier. Any change in water level also can affect docking to a fixed pier.

## Tides on Coastal Waters

- Tides are created by the sun and moon exerting a pull on the earth. High tides and low tides are predictable, and each one normally occurs twice daily at approximately six-hour intervals.
- Boat operators in coastal waters need to be mindful of the effect of tides. The rise and fall of tides can cause water levels to fluctuate by several feet and also can generate strong currents. Some tidal currents are strong enough that some boats cannot make headway against the current.
- As a boat operator, you need knowledge of the tides in your boating area. It is a good idea to learn how to read the tide tables found in many newspapers in coastal areas. Tide schedules also can be found on weather radio channels.

## Compasses and Charts

A good compass and **chart** are always useful. Having a compass and knowing how to use it are invaluable when darkness, fog, or a storm occurs. Therefore, it's a good idea to take a basic course in navigation, usually available from the U.S. Coast Guard Auxiliary, U.S. Power Squadrons, American Sailing Association, and others.

## Steering Compass

- A compass, which is used to assist in navigation, is an instrument that shows magnetic north. You must apply a correction to determine the direction of true north. The ability to steer a boat by a compass is useful if land is out of sight, visibility is reduced, or the boat operator is disoriented.
- Mount a boat compass away from iron, magnets, and electrical wiring and equipment. Practice with your compass and other navigation equipment in good weather. Make sure you know how to use them. This will give you confidence during bad weather.

## Nautical Charts

- Charts contain important information such as water depths and the locations of channels, sand bars, rocks, and vegetation. This is especially helpful when boating in bays or in large lakes. They also can be used to determine the most direct course possible for fuel conservation.
- Check with the local marina for charts. If none are available, obtain local knowledge before boating in an unfamiliar area.

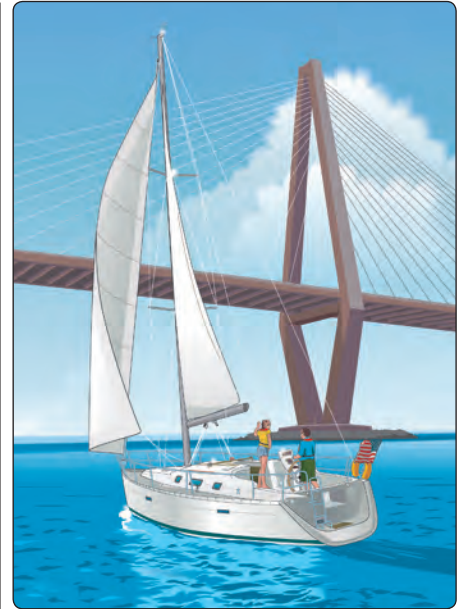

Sailboat operators should always check clearance of the boat's mast before passing under bridges. This can be very difficult to determine from the operator's position on the boat. On charted waters, the chart will indicate bridge clearance at a particular water level. Current water level and tide must be factored in to determine present clearance.

### chart

Map used for navigation



A boat's compass can be invaluable in bad weather and at night. Make sure you know how to use it.



#### wake

Waves that a vessel leaves behind as it moves through the water



### Before You Go Out on Your PWC

Operating a personal watercraft carries the same responsibilities as operating any other vessel. Before taking your PWC out on the water, you should:

- ✓ Read and understand the owner's manual.
- ✓ Take time to review the video most PWC manufacturers provide.
- ✓ Inspect your PWC periodically, and perform necessary maintenance to keep it in good operating condition.
- ✓ Be aware of all local, state, and federal laws that apply to PWCs. See Chapter 4 for more about these legal requirements.
- ✓ Do not forget that in addition to obeying all boating laws, the PWC operator must adhere to laws specific to personal watercraft.

## Operating a Personal Watercraft

Although a personal watercraft (PWC) is considered an inboard vessel and operators must follow the same rules and requirements that apply to other vessels, there are additional, specific considerations for the PWC operator.

### Steering and Stopping a PWC

- PWCs are propelled by a jet drive where water is drawn into a pump and then forced out under pressure through a steering nozzle at the back of the unit. This “jet” of pressurized water is directed by the steering control—when the steering control is turned, the steering nozzle turns in the same direction. For example, if the steering control is turned right, the nozzle turns right and the jet of water pushes the back of the vessel to the left, which causes the PWC to turn right.
- The most important thing to remember about steering most PWCs (and other jet-drive vessels) is that you always must have power in order to maintain control. ***If you allow the engine on these PWCs to return to idle or shut off during operation, you lose all steering control.*** Many PWCs will continue in the direction they were headed before the engine was shut off, no matter which way the steering control is turned. New PWCs allow for off-throttle steering.
- Always allow plenty of room for stopping. Just because you release the throttle or shut off the engine does not mean you will stop immediately. Even PWCs that have a braking system do not stop immediately.

### Courtesy on the Water

While these rules of courteous operation are especially important for PWC operators, they apply to all other vessel operators as well.

- Jumping the **wake** of a passing boat, or riding too close to another PWC or boat, creates risks and is restricted or even prohibited in some states. Here's why.
  - The boat making the wake may block the PWC operator's view of oncoming traffic and also conceal the PWC operator from approaching vessels.
  - It can be very stressful for boat operators to have PWCs continually in close proximity to their boats.
  - Wake jumping and riding too close to other vessels are common complaints others have against PWC operators.
- Do not attempt to spray others with the wake of your PWC. Not only is this discourteous, but it is also dangerous and reckless operation.
- Excessive noise from personal watercraft often makes them unwelcome with other vessel operators, as well as with people on shore. Here are some tips on how you can be a courteous PWC operator.
  - Vary your operating area, and do not keep repeating the same maneuver.
  - Avoid congregating with other PWC operators near shore, which increases annoying noise levels.
  - Avoid making excessive noise near residential and camping areas, particularly early in the morning. Excessive use in one area can be an irritant to people who are there to enjoy a quiet and relaxing time.
  - Avoid maneuvers that cause the engine exhaust to lift out of the water because that increases noise levels.
  - Do not modify your engine exhaust system if it increases the noise. Improperly modified exhausts will not make your PWC faster and may raise the noise to an illegal level.
- Share the waterways responsibly with other boaters, fishermen, swimmers, surfers, or skiers. Respect their right to use the waterways safely and enjoyably.

## Environmental Considerations

When operating your personal watercraft, always consider the effect you may have on the environment.

- Make sure that the water you operate in is at least 30 inches deep. Riding in shallow water can cause bottom sediments or aquatic vegetation to be sucked into the pump, damaging your PWC and the environment.
- Avoid causing erosion by operating at slow speed and by not creating a wake when operating near shore or in narrow streams or rivers.
- Do not dock or beach your PWC in reeds and grasses. This could damage fragile environments.
- Take extra care when fueling your PWC in or near the water. Oil and gasoline spills are very detrimental to the aquatic environment. Fuel on land if possible.
- Never use your PWC to disturb, chase, or harass wildlife.

## Other PWC Considerations

- Regulations concerning PWCs can vary from state to state. See Chapter 4 for additional PWC regulations.
- A PWC is very maneuverable and responsive to slight turns of the steering control. At high speeds, a quick turn can make the PWC unstable, causing the operator and passengers to fall off. This is why most states require that everyone on board a PWC wear a personal flotation device (life jacket). Check Chapter 4 for more on personal flotation devices.
- Any passenger on a PWC should be able to hold on securely to the person in front of them or to the handholds, while keeping both feet firmly on the footrests. Children who are too small to be able to do this should not ride.
- A passenger on a PWC should never be seated in front of the operator.
- Keep hands, feet, loose clothing, and hair away from the pump intake area. Before cleaning debris from the pump intake, be sure to shut off the engine.
- The jet of water exiting the steering nozzle at the rear of the PWC can cause severe internal injuries. Anyone riding on a PWC should wear a wetsuit or other clothing that provides similar protection. Also, keep everyone clear of the steering nozzle unless the PWC is shut off.
- Frequently inspect your PWC's electrical systems (e.g., starter and engine gauge connections) to ensure there is no potential for electrical spark. This is important because gas fumes could collect in the engine compartment and an explosion could occur if a spark from the electrical system ignited the fumes. After fueling, sniff the engine compartment for any evidence of gas fumes.
- Never exceed the manufacturer's recommended capacity for your PWC.
- Know your limits, and ride according to your abilities.

## Reboarding a Capsized PWC

PWCs are designed to turn over and that's part of what makes them fun, but it's also why it is very important that the engine cut-off switch is attached to the operator. After a fall, the PWC could be overturned completely. You should know how to right the PWC and how to reboard from the rear of the craft.

- Most manufacturers have placed a decal at the rear or bottom of the craft that indicates the direction to roll your PWC to return it to an upright position. If no decal exists, check your owner's manual or ask the dealer. With this information, you should be able to roll the PWC over and reboard with little trouble. If you roll it over the wrong way, you could damage your PWC.
- It is a good idea to practice reboarding with someone else around to make sure you can handle it alone. Don't ride your PWC if you are very tired because reboarding would be difficult. Also, avoid riding where there are strong currents or winds, which could hamper your reboarding efforts.

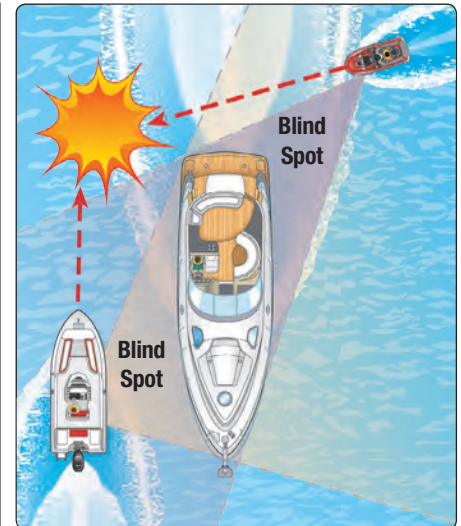

PWC operators need to beware of passing too closely behind another vessel. The vessel will block your view of oncoming vessels, as well as the oncoming vessel's view of the PWC.

### Boater's Tip



Because a PWC is very maneuverable it is possible for a PWC to get into trouble fast. Here are some important things to do when operating a PWC.

Do not ride too closely behind another PWC. If it turns sharply or if it stalls, you could collide with it; if the other rider falls off, you could run over him or her.

Always look behind you over both shoulders before making turns; another vessel may be too close behind you.

Be aware of all traffic in your boating area; don't focus just on the short distance ahead.

Always remember that operating a PWC has the same responsibilities as operating any other vessel.



Look for the decal on the rear of the PWC to determine the direction to roll it to return it to an upright position.

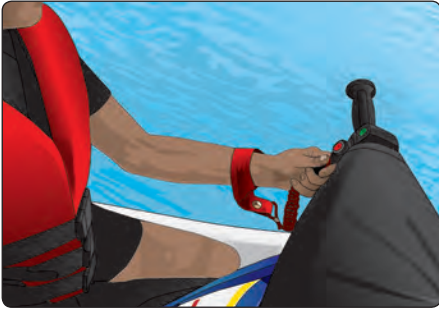

### lanyard

Short cord used for fastening something or securing rigging; on a PWC and most powerboats, it attaches the engine cut-off switch to the operator's wrist or life jacket

## Devices That Reduce Propeller Strikes

Several new technologies are available to reduce propeller strikes. The devices fall into the following categories.

- **Guards:** Devices that provide some type of physical barrier around the propeller. These include deflection devices, full cages, ring guards, ringed props, and "Kort Knuzzles."
- **Propulsion:** Devices other than a propeller such as jet drives and pump jets.
- **Interlocks:** Devices that automatically turn off the engine or sound an alarm. For example, a ladder interlock stops the engine or triggers an alarm when passengers use the ladder to enter or leave the water.
- **Sensors:** Wireless sensors or other devices worn by boaters that shut off the boat's engine or trigger an alarm if the wearer falls overboard.

For more information, visit the U.S. Coast Guard's boating safety website: <http://www.uscgboating.org/recreational-boaters/>

### Remember...

A PFD does more than keep you afloat to prevent you from drowning. It also can help a boater spot you more easily.

## Ignition Safety (Engine Shut-Off) Switches

Most powerboats and PWCs come equipped by the manufacturer with an emergency engine cut-off switch. This safety device can shut off the engine if the operator falls off the PWC or out of the powerboat, or is otherwise thrown from the proper operating position.

- A **lanyard** connects the safety switch to the operator's wrist or PFD. When the lanyard is pulled from the switch, the engine shuts off.
- If a PWC has an engine cut-off switch, most states require the operator to attach the lanyard. (Most states do not require powerboat operators to attach the lanyard. See Chapter 4 for more on these requirements.) However, even if attaching the lanyard is not required by law, many lives could be saved by doing so. If your powerboat or PWC does not have an engine cut-off switch, you should have one installed.
- Your PWC may have a self-circling feature. If the operator is thrown from the PWC, the engine idles while the PWC slowly circles so that the operator can reboard. Be sure the idle speed is set correctly.

### Use of Engine Cut-Off Switches Helps Prevent Propeller Strikes

Each year, many boating accidents involve an operator and/or passengers who fall overboard for a variety of reasons. Wearing an engine cut-off switch lanyard not only ensures that your boat or PWC stays close if you fall overboard, but it also prevents you from being run over by your own boat. When the operator isn't wearing a lanyard, the unmanned boat tends to run in hard, fast circles, often resulting in severe injury or death from a propeller strike. Wearing the lanyard reduces the risk of a propeller injury and makes it easier to reboard the boat.

## Avoiding Propeller Strike Injuries

If you've ever seen a propeller strike accident, you want to do everything in your power to prevent another one. They can be the most gruesome of boating accidents. Anyone in the water around a boat—a swimmer, scuba diver, fallen water-skier, or someone who's fallen overboard—is a potential victim. Many propeller accidents are caused by operator inexperience, incompetence, negligence, and intoxication. However, most accidents can be prevented if operators follow a few simple safety practices.

- **Turn off the engine when passengers are boarding or disembarking.** Propellers should not be spinning when a passenger is in a vulnerable situation.
- **Prevent passengers from being thrown overboard accidentally.**
  - Never start a boat with the engine in gear.
  - Never ride on a seat back, gunwale, transom, or bow.
  - Make sure all passengers are seated properly before getting underway. Some operators cause injuries by putting the engine in gear while people are still swimming or diving from the boat.
  - Assign a responsible adult to watch any children in the boat and sound the alarm if a child falls overboard.
- **Maintain a proper lookout for people in the water.** The primary cause of propeller strike accidents is operator inattention or carelessness.
  - Slow down when approaching congested areas and anchorages. In congested areas, always be alert for swimmers and divers.
  - Learn to recognize warning buoys that mark swimming and other hazardous areas.
  - Keep the boat away from marked swimming and diving areas. Become familiar with the red flag with a white diagonal stripe and the blue-and-white "Alfa" flag—both signal that divers are down.

## Your Vessel's Registration

- Requirements for vessel registration vary from state to state. In Nebraska, you must have a Nebraska Certificate of Number (registration) and validation stickers to legally operate a vessel propelled by a mechanical device on any public or private waters, including the Missouri River and Lewis and Clark Lake. Exceptions to the requirement to register include:
  - Vessels not powered by machinery at any time
  - Vessels properly registered in another state and using Nebraska waters for less than 60 consecutive days
  - Vessels documented with the U.S. Coast Guard
- If your vessel requires registration, it is illegal to operate or allow others to operate your vessel unless it is registered and numbered.
- Registration application forms are available from the county treasurer of the boater's county of residence. Current registrations may be renewed online at the Nebraska Game and Parks Commission website: [www.outdoornebraska.ne.gov/boating/](http://www.outdoornebraska.ne.gov/boating/).
- After registering a vessel, an owner will receive a *Certificate of Number (registration card)* that must be available for law enforcement inspection whenever the vessel is operated.
- Registration is valid for three years and expires on December 31 at the end of each three-year period. No vessel may be operated after December 31 without renewing the registration.
- If a Certificate of Number is lost or destroyed, the vessel owner must apply to the county treasurer to replace it with a duplicate Certificate of Number.
- The owner of a registered vessel must notify the Game and Parks Commission within 15 days of the following events:
  - The owner changes his or her address
  - The owner transfers all or any part of his or her interest in the vessel
  - The vessel is destroyed or abandoned
- Larger recreational vessels owned by U.S. citizens may (at the option of the owner) be documented by the U.S. Coast Guard (USCG). Call the USCG at **1-800-799-8362** for more information.

## Displaying the Assigned Number and Validation Stickers

- The registration number and validation stickers must be displayed as follows:
  - Number must be placed on each side of the forward half of the vessel.
  - Number must read from left to right on one line, starting with the validation sticker followed by two capital letters—"NB"—followed by a 2-inch space and three or four digits followed by a 2-inch space and two or three capital letters. For example: **NB 123 ABC**.
  - Letters and numerals must be **BLOCK** figures at least three inches high, of a color that contrasts with its background and visible from 100 feet.
- No numerals and letters other than the registration numerals, letters and validation stickers may be displayed on either side of the forward half of any mechanically powered vessel.

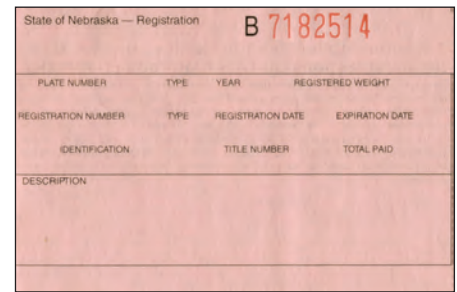

### Certificate of Number (Registration)

The Certificate of Number must be carried on board the vessel whenever the vessel is operated.

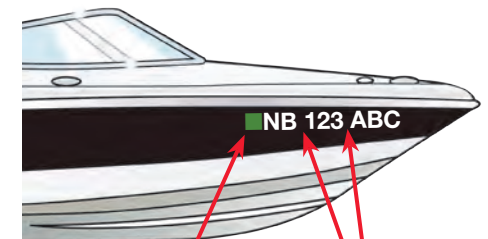

2-inch spaces should appear here.

### Validation Sticker



PWCs are also required to display the registration number and validation stickers.

### Hull Identification Number

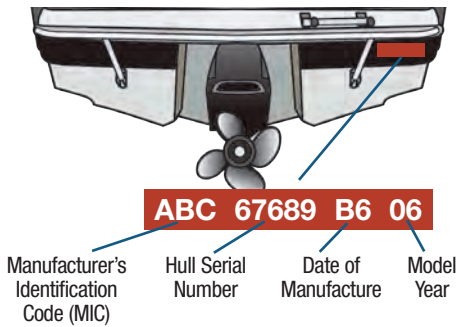

### Registration Questions?

Call Nebraska Game and Parks Commission at **1-402-471-0641** or visit our website at [www.outdoornebraska.ne.gov/boating/](http://www.outdoornebraska.ne.gov/boating/)

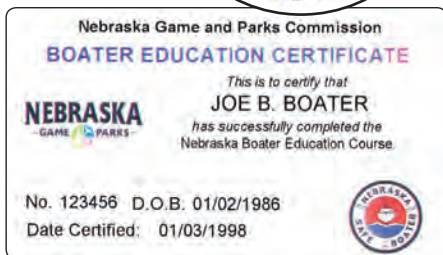

### Boating Safety Certificate

Operators required to have a boating safety certificate must carry the wallet-sized certificate issued by the Nebraska Game and Parks Commission on board the vessel.

### Your Vessel's Title

- All first-time owners of newly acquired motorized vessels must obtain a title from the County Clerk in the county where the owner resides before the County Treasurer will issue or renew registration.
- No person may sell a motorized vessel without providing a Certificate of Title that assigns the title to the purchaser.
- All vessels manufactured prior to Nov. 1, 1972, are exempt from titling but not from registration.

### Hull Identification Number

- The Hull Identification Number (HIN) is a unique 12-digit number, assigned by the manufacturer.
- Hull Identification Numbers:
  - Distinguish one vessel from another—the same as serial numbers distinguish one car from another
  - Are engraved in the fiberglass or on a metal plate permanently attached to the transom
  - Should be recorded by the owner and put in a place other than the vessel in case warranty problems arise or the vessel is lost or stolen.
- All vessels built after November 1, 1972, including homemade boats, must have a Hull Identification Number (HIN). The HIN is required by federal law and it must appear on the registration application.
- If a vessel has no HIN, one must be obtained from the Nebraska Department of Motor Vehicles before a title and registration can be issued.

### Who May Operate a Vessel

- **No one under the age of 14** may operate a motorboat or personal watercraft (PWC) on Nebraska's public waters.
- **No one under the age of 16** is allowed to tow an individual with a vessel.
- **No one born after December 31, 1985**, is allowed to operate a motorboat or personal watercraft on the waters of Nebraska unless he or she has successfully completed a boater safety course and has been issued a valid boating safety certificate.
  - The boater safety course must be one that is approved by the Nebraska Game and Parks Commission.
  - Individuals who are required to complete a boater safety course before operating a vessel must carry the course certificate on board the vessel.
- **No one under the age of 18** may rent or lease a PWC.

## Unlawful Operation

Nebraska law states that these dangerous operating practices are illegal:

- **Negligent or Reckless Operation** of a vessel or the reckless manipulation of water-skis, a surfboard, or similar device is operating in a manner that causes danger to the life, limb, or property of any person. Examples of negligent or reckless operation are:
  - Jumping a wake with a motorized vessel within 50 yards of another vessel
  - Jumping the wake of any vessel that is towing a skier, tuber, wakeboarder, etc.
  - Operating a vessel within any area marked off or set aside as a prohibited area
  - Weaving your vessel through congested waterway traffic
  - Steering toward another object or person in the water and swerving at the last possible moment in order to avoid collision
  - Chasing, harassing or disturbing wildlife with your vessel
- **Improper Speed or Distance** is not maintaining a proper speed and/or distance while operating a vessel. Specifically, it is illegal to:
  - Operate a vessel at a distance from other vessels or at a speed that exceeds safe and reasonable limits given the waterway traffic, marked speed limits, weather and other boating conditions
  - Exceed the speeds posted or charted in any specific zone or area
  - Exceed speeds of 5 mph (“**slow, no wake speed**”) within 30 yards of any vessel, harbor, marina, landing pier, fishing pier, anchorage, or bathing beach
- **Riding on Bow or Gunwales** is allowing passengers to ride on the bow decking, **gunwales**, or any other position where there is a danger of falling **overboard**.
- **Overloading** is defined as operating a vessel that has been loaded beyond the recommended capacity shown on the capacity plate installed by the vessel manufacturer. At least one half of a vessel’s total depth, measured at the center of the vessel, must remain above water.
- **Unsafe Condition** is placing or leaving in public waters any vessel that is not safe to operate. Law enforcement officers may instruct the operator to take immediate corrective action or return to mooring if any of the following “unsafe conditions” exist:
  - The vessel is overloaded
  - There are insufficient life jackets (wearable PFDs), fire extinguishers, backfire flame arrestors, ventilation, or navigation lights
  - The vessel is leaking fuel or has fuel in the bilges
- **Operating on Wildlife Refuge Areas** is operating a motorboat from October 15 through January 15 on any the following state wildlife refuges:
  - Garden County Refuge, North Platte River
  - Lincoln County Refuge, North Platte River
  - Dodge–Saunders County Refuge, Platte River
  - Boyd–Holt County Refuge, Niobrara River
  - Lake Babcock, Platte County, closed to all vessels during the open waterfowl season

## Remember...

As an owner of a vessel, you are responsible for any injury or damage caused by the reckless or negligent operation of others you allow to use your vessel.

## No Swimming Areas

Swimming or bathing is forbidden in any marinas or within 20 yards of launching, mooring, or docking areas.

### “slow, no wake speed”

A speed at which the vessel does not produce an excessive wake, not to exceed 5 miles per hour

### gunwale

Upper edge of vessel’s side (generally pronounced “gunnel”)

### overboard

Over the side or out of the vessel

The U.S. Coast Guard Auxiliary and U.S. Power Squadrons will perform a Vessel Safety Check (VSC) of your vessel and equipment free of charge. This inspection covers federal and state requirements. If your vessel meets all VSC requirements, you will receive a VSC decal. If your vessel fails to meet all requirements, no report is made to any law enforcement agency.

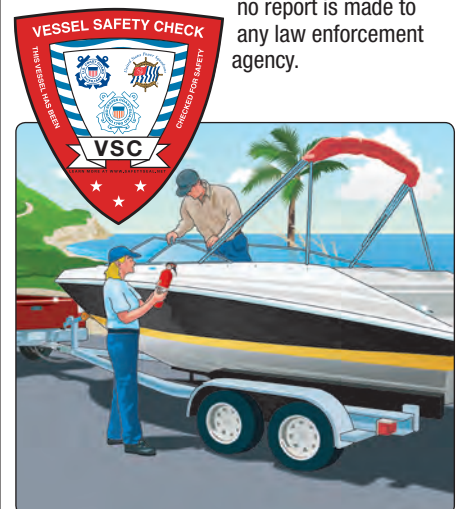



The best thing you can do for your safety and the safety of your passengers and other boaters is simple... **Don't Drink and Boat!**

### Areas of Impairment due to Blood Alcohol Concentration (BAC)

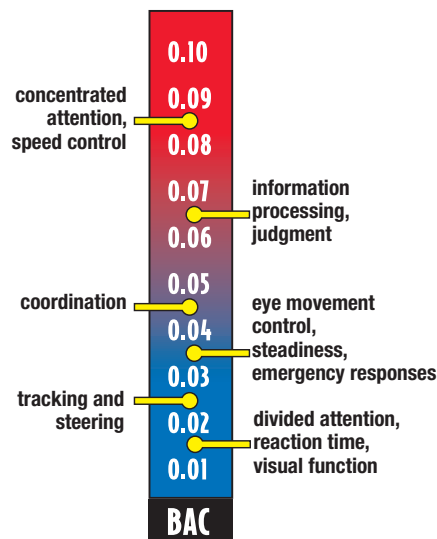

Because you can drink faster than your system can burn off the alcohol, there is an increasing level of alcohol in your blood. This level is referred to as Blood Alcohol Concentration (BAC).

#### moor

To keep a vessel in place by setting anchor or tying the vessel to a fixed object or buoy



Avoid all security zones and restricted areas. Keep a sharp eye out for anything that looks peculiar or out of the ordinary.

## Alcohol and Drugs

Nebraska law prohibits operating a motorboat while under the influence of alcohol or drugs. Alcohol and drugs cause impaired balance, blurred vision, poor coordination, impaired judgment, and slow reaction time. Alcohol is a major contributor to boating accidents and fatalities. Read more about the effects and risks of consuming alcohol in Chapter 5.

- Anyone who operates or attempts to operate a vessel is deemed to have given consent to an alcohol and/or drug test. Any person who refuses to submit to a preliminary breath test will be found guilty of a Class III misdemeanor.
- Nebraska law states that a person is considered to be operating a vessel under the influence of alcohol or drugs if he or she:
  - Has a blood or breath alcohol concentration of 0.08% or greater *or...*
  - Is under the influence of any controlled substance or any other drug, or any combination of alcohol, controlled substance, or drugs that renders that person incapable of operating safely
- Any person who is operating a vessel while under the influence of alcohol or a controlled substance is guilty of Boating Under the Influence (BUI), a Class II misdemeanor. The penalty for BUI includes a fine up to \$1,000, jail time up to six months, and the loss of boating privileges for six months.
- If the court places a person on probation or suspends the sentence, a person may not operate a vessel for 60 days from the date of the order. The court may also require a convicted person to attend and pay for an alcoholism treatment program as a term of probation.

## Obstructing Navigation

Vessel operators should always be considerate of other vessel operators even when stopping to anchor or **moor**. Keep in mind that it is illegal to:

- Operate any vessel in such a way that it will unnecessarily interfere with the safe navigation of other vessels on the waterway
- Anchor a vessel in the traveled portion of a river or channel that will prevent or interfere with any other vessel passing through the same area
- Moor or attach a vessel to a buoy (other than a mooring buoy), beacon, light, or any other navigational aid placed on public waters by proper authorities
- Move, displace, tamper with, damage, or destroy any navigational aid

## Homeland Security Restrictions

Recreational boaters have a role in keeping our waterways safe and secure.

- Observe and avoid all security zones, including restricted areas near dams and power plants. Do not stop or anchor beneath bridges or in the channel. Violators can expect a swift and severe response.
- Keep a sharp eye out for anything that looks peculiar or out of the ordinary. Report all suspicious activities to local authorities or the U.S. Coast Guard.



## Life Jackets (Personal Flotation Devices)

All vessels must be equipped with U.S. Coast Guard–approved life jackets, also called personal flotation devices (PFDs). The quantity and type depends on the length of your vessel and the number of people on board and/or being towed. Each life jacket must be in good condition, the proper size for the intended wearer, and very importantly, must be readily accessible! Readily accessible means you must be able to put the life jacket on in a reasonable amount of time in an emergency (vessel sinking, on fire, etc.). Life jackets should not be stowed in plastic bags, in locked or closed compartments, or have other gear stowed on top of them.

Vessel operators should ask everyone on their vessel to wear a life jacket whenever on the water. *Life jackets can save lives, but only if they are worn!*

### PFD Requirements

- All vessels must have at least one USCG-approved Type I, II, III, or V life jacket for each person on board and being towed. All vessels, except personal watercraft, canoes and kayaks, must also carry one USCG-approved throwable Type IV device.
- Persons less than 13 years of age must wear a USCG-approved Type I, II, or III life jacket while on board or being towed by a vessel. A life belt or ring will not satisfy the requirement.
- A personal watercraft may not be operated unless each person on board is wearing a USCG-approved Type I, II, III, or V life jacket.
- Sailboarders are not required to wear a life jacket, but it is recommended.
- Inflatable life jackets should not be used by nonswimmers or anyone under the age of 16. USCG-approved inflatable life jackets are fairly new and caution should be practiced when using one.
- All life jackets must be in good and serviceable condition and readily accessible. The life jackets must be of the proper size for the intended wearer. Sizing for life jackets is based on body weight and chest size.

### PFD Descriptions

#### TYPE I: Wearable Offshore Life Jackets

These vests are geared for rough or remote waters where rescue may take awhile. They provide the most buoyancy, are excellent for flotation, and will turn most unconscious persons face up in the water.

#### TYPE II: Wearable Near-Shore Vests

These vests are good for calm waters when quick assistance or rescue is likely. Type II vests will turn some unconscious wearers face up in the water, but the turning is not as pronounced as with a Type I.

#### TYPE III: Wearable Flotation Aids

These vests or full-sleeved jackets are good for calm waters when quick assistance or rescue is likely. They are not recommended for rough waters since they will not turn most unconscious persons face up. Type III PFDs are used for water sports such as water-skiing. Some Type III PFDs are designed to inflate when you enter the water.

#### TYPE IV: Throwable Devices/Not Wearable

These cushions and ring buoys are designed to be thrown to someone in trouble. Since a Type IV PFD is not designed to be worn, it is neither for rough waters nor for persons who are unable to hold onto it.

#### TYPE V: Special-Use Devices

These vests, deck suits, hybrid life jackets (inflatables), and others are designed for specific activities such as windsurfing, kayaking, or water-skiing. Some Type V life jackets are designed to inflate when you enter the water. *To be acceptable, Type V PFDs must be used in accordance with their label.*

### Boater's Tip



An emergency situation (rough water, rapid onset of bad weather, or dangerous boating traffic) can occur suddenly—leaving little or no time to put on life jackets. Life jackets are very difficult to put on once you are in the water. Be a smart boater, and have everyone on board your vessel wear their life jackets at all times.

### Types of Personal Flotation Devices

Read and follow the label restrictions on all PFDs.

#### Wearable Life Jackets (PFDs)



Inflatable

#### Throwable Personal Flotation Devices

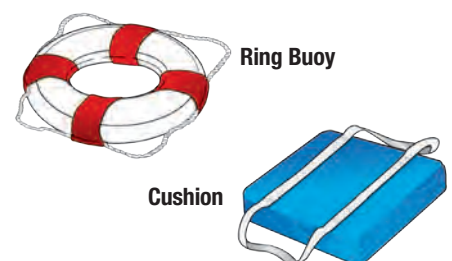

Ring Buoy

Cushion

### Boater's Tip



PWC operators need to take special steps in case of fire. Because their fire extinguishers may not be easily accessible, they should simply swim away quickly and use another operator's extinguisher. They should not open the engine compartment to put out the fire.

### Fire Extinguisher Charge Indicators

Check the charge level of your fire extinguishers regularly. Replace them immediately if they are not fully charged.

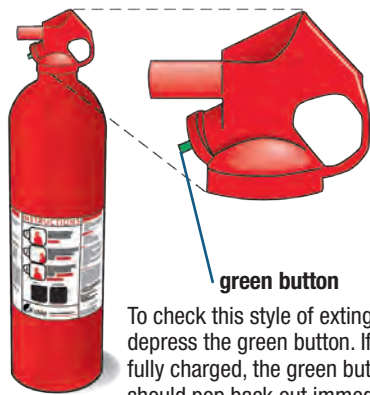

**green button**  
To check this style of extinguisher, depress the green button. If it is fully charged, the green button should pop back out immediately.



On this style of fire extinguisher, the needle indicator should be in the "full" range.

### Remember...

Keep bilges clean and free of trash in order to reduce the risk of fire.

## Fire Extinguishers

- Extinguishers are classified by a letter and number symbol. The number indicates the relative size of the extinguisher and the letter indicates the type of fire it will extinguish:
- **Type A** fires are of combustible solids like wood.
- **Type B** fires are of flammable liquids like gasoline or oil.
- **Type C** fires are electrical fires.
- All vessels are required to have a Type B fire extinguisher on board if one or more of the following conditions exist:
  - Inboard/outboard or inboard engine
  - Closed compartments
  - Closed living spaces
  - Closed storage compartments in which flammable or combustible materials may be stored
  - Permanently installed fuel tanks
- Approved types of fire extinguishers are identified by the following marking on the label—"Marine Type USCG Approved"—followed by the size and type symbols and the approval number.

Use this chart to determine the type and quantity of fire extinguishers required for your vessel.

Length of Vessel	Without Fixed System	With Fixed System*
Less than 26 feet	one B-I	None
26 feet to less than 40 feet	two B-I or one B-II	one B-I
40 feet to less than 65 feet	three B-I or one B-II and one B-I	two B-I or one B-II

\* refers to a permanently installed fire extinguisher system

- Extinguishers should be placed in an accessible area—not near the engine or in a compartment, but where they can be reached immediately. Be sure you know how to operate them.
- Fire extinguishers must be maintained in usable condition. Inspect extinguishers regularly to make sure that:
  - Seals and tamper indicators are not broken or missing
  - Pressure gauges or indicators read in the operable range
  - There is no physical damage, corrosion, leakage or clogged nozzles

## Backfire Flame Arrestors

Because boat engines may **backfire**, all powerboats (except outboards) that are fueled with gasoline must have an approved backfire flame arrestor on each carburetor. Backfire flame arrestors are designed to prevent the ignition of gasoline vapors in case the engine backfires.

- Backfire flame arrestors must be:
  - In good and serviceable condition
  - U.S. Coast Guard–approved (must comply with SAE J-1928 or UL 1111 standards)
- Periodically clean the flame arrestor(s) and check for any damage.

## Ventilation Systems

Ventilation systems are crucial. Their purpose is to avoid explosions by removing flammable gases. Properly installed ventilation systems greatly reduce the chance of a life-threatening explosion.

- All gasoline-powered vessels, constructed in a way that would entrap fumes, must have at least two ventilation ducts fitted with **cowls** to remove the fumes. At least one exhaust duct must extend from the open atmosphere to the lower bilge. At least one intake duct must extend from a point at least midway to the bilge or below the level of the carburetor air intake.
- If your vessel is equipped with a power ventilation system, turn it on for at least four minutes in either of these situations:
  - After fueling
  - Before starting the engine
- If your vessel is not equipped with a power ventilation system (for example, a personal watercraft), open the engine compartment and sniff for gasoline fumes before starting the engine.

## Mufflers and Noise Level Limits

Excessive noise can prevent a vessel operator from hearing signals and voices.

- The exhaust of every internal combustion engine on any vessel must be effectively muffled. That is, the engine's exhaust must be muffled or suppressed at all times so as not to create excessive noise.
- It is unlawful to operate a vessel that exceeds a noise level of 96 db when measured at 100 feet while the vessel is traveling on plane.
- The use of cutouts is prohibited.



### WARNING:

Gasoline vapors can explode. Before starting engine, operate blower for four minutes and check (using your nose) engine compartment for gasoline vapors.

Vessels built after July 31, 1980, which contain power exhaust blowers in gasoline engine compartments, must have the above warning sticker placed near the instrument panel.

### backfire

Explosion of prematurely ignited fuel or of unburned exhaust gases in an internal combustion engine

### cowl

Hooded opening designed to scoop in air

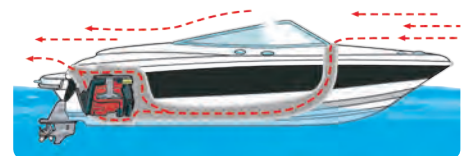

Powerboats are built to ventilate the engine when underway. As the boat moves along, an air intake scoops up fresh air and forces it down the air duct into the engine compartment. The exhaust sucks out the explosive fumes from the lowest part of the engine and fuel compartments.

## 1. Power-Driven Vessels Less Than 65.6 Feet

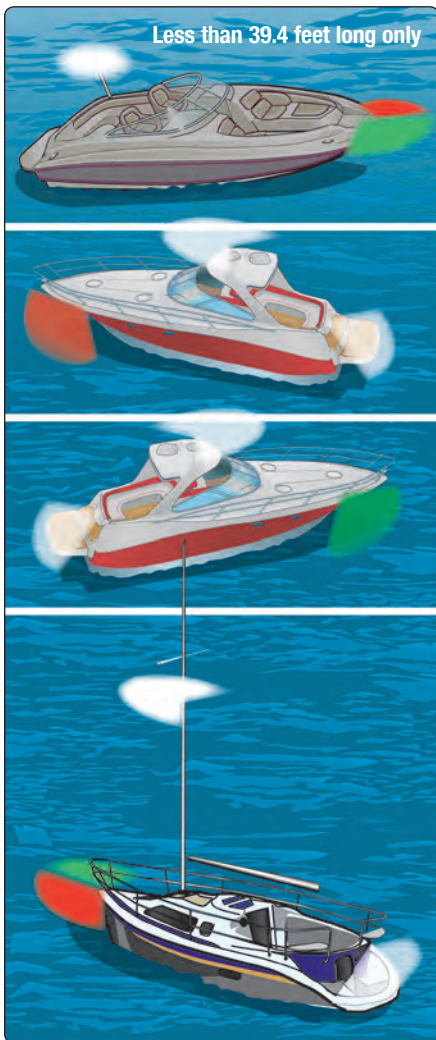

The red and green lighting must conform to the illustration above. Red should be on the left side of the bow and green on the right side of the bow.

## 2. Unpowered Vessels Less Than 65.6 Feet



An alternative to the sidelights and sternlight is a combination red, green, and white light, which must be exhibited near the top of the mast.

## Navigation Lights

- Vessel operators must make sure that their vessels are equipped with the proper navigation lights and use the lights during these conditions:
  - When away from the dock between sunset and sunrise.
  - During periods of restricted visibility, such as fog or heavy rain.
- The different types of navigation lights are described in “Night Navigation” in Chapter 3. Don’t exhibit any other lights that may be mistaken for required navigation lights. Note: Blue or red flashing lights are restricted to law enforcement vessels only.
- The federal requirements listed below for navigation lights differ depending on the type and size of your vessel. Nebraska state law differs slightly but also accepts these federal requirements. Nebraska law requires also that all vessels carry on board a flashlight or lantern for emergencies. For requirements for larger vessels, see the U.S. Coast Guard’s “Navigation Rules.”

### Power-Driven Vessels Less Than 20 Meters Long When Underway

Vessels less than 20 meters (65.6 ft.) long must exhibit lights as shown in illustration 1. Remember, power-driven vessels include sailboats operating under power. The required lights are:

- Red and green sidelights visible from a distance of at least two miles—or if less than 12 meters (39.4 ft.) long, at least one mile—on a dark, clear night.
- An all-round white light or both a masthead light and a sternlight. These lights must be visible from a distance of at least two miles on a dark, clear night. The all-round white light (or the masthead light) must be at least one meter (3.3 ft.) higher than the sidelights.

### Unpowered Vessels When Underway

Unpowered vessels are sailing vessels or those that are paddled, poled, and rowed.

- Vessels less than 20 meters (65.6 ft.) long must exhibit the lights as shown in illustration 2:
  - Red and green sidelights visible from a distance of at least two miles—or if less than 12 meters (39.4 ft.) long, at least one mile—on a dark, clear night
  - A sternlight visible from a distance of at least two miles.
- Vessels less than 7 meters (23 ft.) long should:
  - If practical, exhibit the same lights as required for unpowered vessels less than 20 meters (65.6 ft.) in length.
  - If not practical, shine a white light from a lantern or flashlight as shown in illustration 3.

### All Vessels When Not Underway

Between sunset and sunrise, all vessels are required to display a white light visible from all directions whenever they are anchored away from a dock or moored in an area other than a designated mooring area.

## 3. Unpowered Vessels Less Than 23 Feet



To prevent a collision, vessel operators should never leave shore without a flashlight. Even if you plan to return before dark, unforeseen developments might delay your return past nightfall.

## Visual Distress Signals

Visual Distress Signals (VDSs) allow vessel operators to signal for help in the event of an emergency. VDSs are classified as day signals (visible in bright sunlight), night signals (visible at night), or both day and night signals. VDSs are either pyrotechnic (smoke and flames) or non-pyrotechnic (non-combustible).

- Vessels on **federally controlled waters** must be equipped with U.S. Coast Guard–approved visual distress signals. All vessels, regardless of length or type, are required to carry night signals when operating between sunset and sunrise. Most vessels must carry day signals also; exceptions to the requirement for day signals are:
  - Recreational vessels that are less than 16 feet in length
  - Non-motorized open sailboats that are less than 26 feet in length
  - Manually propelled vessels
- VDSs must be U.S. Coast Guard–approved, in serviceable condition, and readily accessible.

### U.S. Coast Guard–Approved Visual Distress Signals



#### Pyrotechnic Visual Distress Signals

Orange Smoke—Handheld  
Orange Smoke—Floating

#### Day Signal

Red Meteor

#### Day and Night Signal

Red Flare

#### Day and Night Signal

#### Non-Pyrotechnic Visual Distress Signals

Electric Light

#### Night Signal

Orange Flag

#### Day Signal

- If pyrotechnic VDSs are used, they must be dated. Expired VDSs may be carried on board, but a minimum of three unexpired VDSs must be carried in the vessel.
- The following combinations of signals are examples of VDSs that could be carried on board to satisfy U.S. Coast Guard requirements:
  - Three handheld red flares (day and night)
  - One handheld red flare and two red meteors (day and night)
  - One handheld orange smoke signal (day), two floating orange smoke signals (day), and one electric light (night only)
- It is prohibited to display visual distress signals while on the water unless assistance is required to prevent immediate or potential danger to persons on board a vessel.

## Pyrotechnic Devices

- Pyrotechnics are excellent distress signals. However, there is potential for injury and property damage if not handled properly. These devices produce a very hot flame, and the residue can cause burns and ignite flammable materials.
- Pistol-launched and handheld parachute flares and meteors have many characteristics of a firearm and must be handled with caution. In some states, they are considered a firearm and are prohibited from use.
- Pyrotechnic devices should be stored in a cool, dry, and prominently marked location.

## Non-Pyrotechnic Devices

- The distress flag is a day signal only. It must be at least 3 x 3 feet with a black square and ball on an orange background.
- The electric distress light is accepted for night use only and must flash the international SOS distress signal automatically.



### Arm Signal

Although this signal does not meet VDS equipment requirements, wave your arms to summon help if you do not have other distress signals on board.

### federally controlled waters

Waters on which vessels must observe federal requirements, including VDS requirements; these waters include:

- Coastal waters
- The Great Lakes
- Territorial seas
- Bodies of water connected directly to one of the above, up to a point where the body of water is less than two miles wide

## Common Sound Signals

Some common sound signals that you should be familiar with as a recreational boater are as follows.

### Changing Direction

- **One short blast** tells other boaters, "I intend to pass you on my port (left) side."
- **Two short blasts** tell other boaters, "I intend to pass you on my starboard (right) side."
- **Three short blasts** tell other boaters, "I am operating astern propulsion." For some vessels, this tells other boaters, "I am backing up."

### Restricted Visibility

- **One prolonged blast** at intervals of not more than two minutes is the signal used by power-driven vessels when underway.
- **One prolonged blast plus two short blasts** at intervals of not more than two minutes is the signal used by sailing vessels.

### Warning

- **One prolonged blast** is a warning signal (for example, used when coming around a blind bend or exiting a slip).
- **Five (or more) short, rapid blasts** signal danger or signal that you do not understand or that you disagree with the other boater's intentions.



Scuba divers and snorkelers should not place a flag in an area already occupied by other boaters or where their diving operation will impede the normal flow of waterway traffic. Divers also should follow all of the water safety rules themselves.



## Sound-Producing Devices

A sound-producing device is essential in periods of reduced visibility or whenever a vessel operator needs to signal his or her intentions or position. For example, sound signals are required when meeting head-on, crossing, and overtaking (described in Chapter 3). Unnecessary sounding of whistles, horns, bells, or other sound-producing devices is prohibited.

- On Nebraska state waters, requirements for sound-producing devices are:
  - All vessels less than 26 feet in length, which includes PWCs, must have an efficient whistle, horn, or other sound-producing device.
  - All vessels 26 feet or longer must have a bell *and* an efficient horn or other sound-producing device.
- On federally controlled waters, requirements for sound-producing devices are:
  - All vessels less than 20 meters (65.6 ft.) in length, which includes PWCs, must have a mouth-, hand-, or power-operated whistle or horn, or some other means to make an efficient sound signal.
  - All vessels that are 20 meters (65.6 ft.) or more in length must have a bell *and* a whistle or horn.
- No vessel may be equipped with a siren, except vessels used by law enforcement officers.

## Other Equipment and Regulations

- **Diver-Down Flags:** Persons scuba diving, skin diving, snorkeling, or underwater spearfishing must display a red and white Divers Flag to warn other boaters. A diver or underwater spear fisherman must stay within 150 feet of the flag. It is unlawful to display a Divers Flag when not diving. Vessels not engaged in diving operations must remain at least 150 feet away from a displayed flag. The "diver-down" flags are:
  - A rectangular red flag with a white diagonal stripe that is one-fifth the width of the flag. The stripe must run from the top of the hoist to the bottom of the flag. The flag must be at least 12 inches square and mounted on a float or buoy.
  - A blue and white International Code Flag A (or Alfa flag), flown from a vessel restricted in its ability to maneuver. This flag indicates that a vessel is involved in a diving activity.
- **Skier-Down Flag:** Nebraska law requires that vessels towing person(s) on water-skis or similar devices carry a bright orange "skier down" flag, at least 12 inches square or at least 144 square inches in size.
- **Oars:** An oar or paddle must be carried on all vessels, except personal watercraft, sailboards, or similar devices and motorboats 26 feet or longer.
- **Bailing Bucket:** A bailing bucket, efficient bilge pump, or sponge must be carried on all vessels, except personal watercraft, sailboards, or similar devices.
- **Marine Events:** Apply to the Nebraska Game and Parks Commission to obtain authorization for regattas, motorboat, or other boat races, marine parades, tournaments, or exhibitions to be held on state-controlled waters.
  - The person in charge of the event must file an application with the commission at least 30 days in advance of the event.
  - The application must state the date, time, and location of the event.
  - For events held on federally controlled waters, such as the Missouri River, an application must be filed 30 days in advance with the U.S. Coast Guard.
- **Local Regulations:** Many local waterways in Nebraska have specific equipment and operational restrictions in addition to those covered in this chapter. Be sure to check the Nebraska Boating Guide for local regulations before you go out.

## Requirements Specific to Personal Watercraft (PWCs)

In addition to adhering to all boating laws, PWC operators have requirements specific to their watercraft.

- Every person on board a PWC must *wear* a U.S. Coast Guard-approved Type I, II, III, or V life jacket (wearable PFD) that is in good and serviceable condition.
- If the PWC is equipped with a lanyard-type engine cut-off switch, the lanyard must be attached to the person, clothing, or life jacket of the operator.
- A PWC may not be operated between sunset and sunrise.
- A PWC operator must always face forward.
- There are minimum age and boater education requirements for operators of personal watercraft.
- A PWC must be operated in a responsible manner. Maneuvers that endanger people or property are prohibited, including:
  - Weaving through congested vessel traffic
  - Jumping the wake produced by another vessel at a distance of less than 50 yards
  - Jumping the wake produced by a vessel or PWC that is towing a person(s)

## Towing a Person With a Vessel Legally

Vessel operators towing a person(s) on water-skis, aquaplanes, surfboards, inner tubes, or any similar devices must obey these laws:

- A person may not be towed from 30 minutes after sundown to 30 minutes before sunrise.
- A person being towed must *wear* a life preserver or buoyant vest that is in good condition. The only exception is during state-authorized regattas and similar ski and water shows.
- When a vessel is pulling a person on water-skis, surfboards, or similar devices and it is not equipped with a wide-angle rearview mirror, a responsible person at least 12 years old must act as an observer in the vessel with the operator.
- No person under the age of 16 is allowed to tow an individual with a vessel.
- A PWC operator may not tow a person on water-skis or other devices unless the PWC is designed and recommended by the manufacturer to accommodate more than one person.
- When lines are not being used for towing, they must be stowed immediately on board the towing vessel.
- When a water-skier, surfboarder, or someone engaged in a similar activity is down in the water, the vessel operator or observer must display a bright orange flag that is visible for 360 degrees. The flag must be at least 12 inches square or at least 144 square inches.
- Those towing skiers on water-skis, surfboards, or similar devices and those being towed must act in a safe and prudent manner.
  - It is illegal to operate the vessel or manipulate the towing rope, water-skis, or other devices such that the towed device or person collides with any other person or object.
  - Vessels towing persons must stay a safe distance from other vessels, persons in the water, or property belonging to others.

## Remember...

As an owner of a PWC, you are legally responsible if you allow your PWC to be operated by others in violation of Nebraska law.



When towing persons behind your vessel, you are still responsible to follow all other navigation rules and boating laws.



Vessels towing person(s) on water-skis or similar devices must display a bright orange "skier down" flag whenever the towed person(s) is in the water.

## Stay up to date on new boating laws!



Be sure to stay abreast of new boating laws and requirements.

For state boating law information, contact the Nebraska Game and Parks Commission:

- Call 1-402-471-0641
- Visit [www.outdoornebraska.ne.gov/boating/](http://www.outdoornebraska.ne.gov/boating/)

For federal boating laws, visit the U.S. Coast Guard's boating safety website at:

- [www.uscgboating.org](http://www.uscgboating.org)

Information in this manual does not replace what is specifically legal for boating in your state, which is found in state and federal laws.

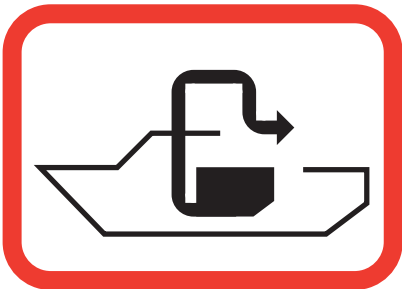

### Pump-Out Station Sign

Signs like these are posted at pump-out stations in Nebraska.



### Pump-Out Station

Y valve must be sealed so waste cannot be discharged into the water

↑  
Drainage to pump-out station



Typical Marine Sanitation Device

It is illegal for any vessel to dump plastic trash anywhere in the ocean or navigable waters of the United States. Annex V of the MARPOL TREATY is a new international law for a cleaner, safer marine environment. Each violation of these requirements may result in civil penalty up to \$25,000, a fine up to \$50,000, and imprisonment up to 5 years.

U.S. lakes, rivers, bays, sounds, and 3 miles from shore	3 to 12 miles	12 to 25 miles	Outside 25 miles
ILLEGAL TO DUMP:	ILLEGAL TO DUMP:	ILLEGAL TO DUMP:	ILLEGAL TO DUMP:
Plastic	Garbage	Plastic	Plastic
Paper	Metal	Dunnage (lining & packing materials that float)	
Rags	Crockery	Also, if not ground to less than one inch:	
Glass	Dunnage	Garbage	
Food		Paper	
		Rags	
		Glass	

States and local regulations may further restrict the disposal of garbage

**Working together we can all make a difference!**

### Garbage Disposal Placard

## Waste, Oil, and Trash Disposal in Nebraska

- It is illegal to discharge waste, oil, or trash into any state or federally controlled waters. This is for very good reasons:
  - Sewage carries disease and other pollutants that are harmful to people, aquatic plants and animals.
  - Trash thrown into the water can injure swimmers and wildlife alike. It can also plug engine cooling water intakes.
  - Pollution is unsightly and takes away from your enjoyment of the water.
- Vessel operators need to be aware of the following regulations for waste, oil, and trash disposal that apply to both federally controlled and state waters. The Refuse Act prohibits throwing, discharging or depositing any refuse matter of any kind (including trash, garbage, oil, and other liquid pollutants) into the waters of the United States.

### Discharge of Sewage and Waste

Nebraska law states that it is unlawful to place, leave or discharge waste or waste containers into or near any Nebraska waters.

- Every vessel with an installed toilet must have an operable U.S. Coast Guard-certified marine sanitation device (MSD) Type I, II, or III.
- The types of MSDs are:
  - Type III MSD, the simplest and most common, consists of holding tanks or portable toilets. It requires only a small storage space and is simple to operate. Type III MSDs have the least effect on the environment because the waste is discharged on shore into a local sewage treatment facility or at a sewage pump-out station.
  - Types I and II MSDs are usually found on large vessels. Waste is treated with special chemicals to kill bacteria before the waste is discharged. Types I and II MSDs with Y valves that direct the waste overboard must be secured in the closed position by a padlock, non-releasable wire tie, or removal of the handle, so that the valve can't be used either accidentally or intentionally.
- All installed MSDs must be U.S. Coast Guard-certified.

### Discharge of Trash

The Act to Prevent Pollution from Ships places limitations on the discharge of garbage from vessels. It is illegal to dump refuse, garbage, or plastics into any state or federally controlled waters.

- You must store trash in a container on board, and place it in a proper receptacle after returning to shore.
- If boating on federal waters, you must display a Garbage Disposal Placard in a prominent location on vessels 26 feet or longer. The Garbage Disposal Placard is a durable sign at least 4 x 9 inches that notifies passengers and crew about discharge restrictions.



## Discharge of Oil and Other Hazardous Substances

Regulations issued under the Federal Water Pollution Control Act require all vessels with propulsion machinery to have a capacity to retain oil mixtures on board.

- You are not allowed to discharge oil or hazardous substances. The penalty for illegal discharge may be a fine up to \$10,000.
- You are not allowed to dump oil into the bilge of the vessel without means for proper disposal. Fuel spills can be removed using absorbent bilge pads.
- You must discharge oil waste to a reception facility. On recreational vessels, a bucket or bailer is adequate.
- You must immediately notify the National Response Center if your vessel discharges oil or hazardous substances in the water. Call the toll-free number 800-424-8802 and report the discharge's location, color, source, substances, size, and time observed.
- If boating on federal waters and your vessel is 26 feet or longer, you must display a 5 x 8-inch sign made of durable material. The sign must be in a conspicuous place in the machinery spaces, or at the bilge pump control station, stating the following:

### Discharge of Oil Prohibited

The Federal Water Pollution Control Act prohibits the discharge of oil or oily waste upon or into any navigable waters of the U.S. The prohibition includes any discharge which causes a film or discoloration of the surface of the water or causes a sludge or emulsion beneath the surface of the water. Violators are subject to substantial civil and/or criminal sanctions including fines and imprisonment.

## Aquatic Nuisance Species Prevention

- **Definition of Aquatic Nuisance Species**—An aquatic nuisance species is a waterborne, non-native organism that threatens the diversity or abundance of native species; the ecological stability of impacted waters; or commercial, agricultural, aquacultural, or recreational activity.
- **Impact**—Nuisance species may cause significant ecological problems because they have been introduced into habitat with pathogens, parasites, or predators. Lack of these natural controls in new habitats may allow a nuisance species to grow exponentially. Introduced nuisance species may prey upon or compete directly with native species and could transmit diseases to native species.
- **Preventive Steps**—Anglers and boaters must take precautions to prevent the introduction or spread of nuisance species. This is especially important to boaters who travel to waters that have nuisance species not present in any Nebraska waters.
- Follow these procedures:
  - It is unlawful for a boat or trailer to leave a launch area with any aquatic vegetation from that body of water still attached.
  - Wash mud and vegetation off waders. Felt-sole wading boots are not allowed. Felt soles can stay damp for some time after wading and have contributed to the spread of some aquatic nuisance species.
  - Zebra and quagga mussels can survive up to two weeks out of water, so after boating in infested water and before launching your boat in a different body of water, rinse your boat and all equipment with hot tap water (more than 140° F). Spray your boat and trailer with a high-pressure sprayer, or dry boat and all equipment for at least five days. Vinegar can also be used to kill young zebra mussels.
  - Run the water out of the lower unit.
  - Clean, drain, and dry your equipment.
  - Game and Parks staff inspection of boats, trailers, and all boating and fishing equipment may be required.

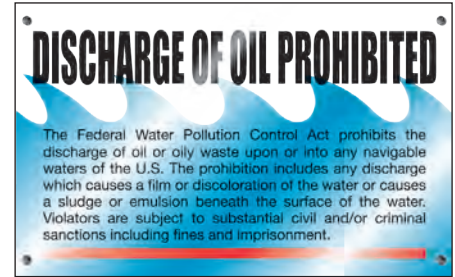

### Oil Discharge Placard

A 5 x 8-inch sign that states the law pertaining to oil discharge



### What to Do in Case of Discharge

If your vessel discharges oil or hazardous substances into the water, notify the National Response Center by calling:

- **1-800-424-8802.**

### Waste Management Plan

Federal law requires ocean going vessels of 40 feet or longer with a galley and berth to have a written Waste Management Plan.

The captain of the vessel is responsible for implementing the Waste Management Plan.

The Waste Management Plan, identifying the vessel's name and home port, should be posted and include directives to all passengers and/or crew about:

- Discharge of sewage and hazardous substances
- Discharge of garbage and other food waste
- Disposal of plastics, bottles, and cans
- Applicable placards for additional information
- Advising the captain in case of oily discharges or diesel spills

## Boating Accident Report Form

The form is titled 'BOATING ACCIDENT REPORT' and includes the following sections:
 

- ACCIDENT DATA:** Date, Time, Location, Vessel No. 1, Vessel No. 2.
- OPERATOR INFORMATION:** Name, Address, Phone, Vessel No.
- WITNESSES:** Name, Address, Phone, Vessel No.
- TYPE OF ACCIDENT:** Collision, Grounding, Obstruction, etc.
- INJURIES AND DAMAGE:** Sections for listing injuries and property damage.
- OTHER PROPERTY DAMAGE INFORMATION:** Section for listing other damaged property.

## Boating Accidents and Casualties... What the Law Requires You to Do

- An operator involved in a boating accident must stop his or her vessel *immediately* at the scene of the accident and:
  - Assist anyone injured or in danger from the accident, unless doing so would seriously endanger his or her own vessel or passengers
  - Give, in writing, his or her name, address, and vessel identification to any person injured and to the owner of any damaged property.
- A vessel operator is required to file a written report whenever a boating accident results in:
  - Loss of life or disappearance of a person *or...*
  - Loss of consciousness, medical treatment, or disability for more than 24 hours *or...*
  - Property damage in excess of \$500
- Reports must be made within 48 hours when the accident resulted in a death, disappearance, or injury. In other cases, reports must be made within five days. All reports must be submitted to the Nebraska Game and Parks Commission, Box 30370, Lincoln, NE 68503.
- Accident report forms are available from any Nebraska Game and Parks Commission office.
- The vessel owner is liable for any injury or damage caused by negligent operation of any powered vessel. The owner is not liable if the vessel is being used without his or her consent unless the operator is a member of his or her immediate family.

## Enforcement

- Nebraska Game and Parks Commission officers and all other peace officers enforce the boating laws of Nebraska. U.S. Coast Guard officers also patrol and have enforcement authority on federally controlled waters.
- Officers have the authority to stop and board your vessel in order to check for compliance with state and federal laws.
  - It is illegal to refuse to follow the directive of a person with law enforcement authority. An operator who has received a visual or audible signal from a law enforcement officer must bring his or her vessel to a stop.



Nebraska Game and Parks Commission officers and all other officers with law enforcement authority have the right to stop and board vessels in order to check for compliance with state and federal laws.

When you go boating, you will encounter hazards and risks. The outcome of these encounters will be determined by your knowledge, skill, and attitude toward safety. It's important to make a boating emergency less likely to happen by taking the proper precautions, but it's equally important to be prepared and know what to do if an emergency occurs.

## Risk Management

Because most accidents are the result of a simple mistake, nearly all accidents are easily preventable.

- The best way to avoid having a serious accident is to take a few simple steps toward accident prevention. The water can be an unfriendly environment if you don't recognize risks and are not properly prepared for them.
- Risk management is the process of recognizing and acting upon accident warning signs or minimizing the effects of an accident if it does occur.
- By taking this safety course, you are practicing risk management. You've already reduced the chance that you will be involved in a dangerous boating emergency by learning safe boating practices.
  - You now know the "rules of the road" and how important it is to pay close attention to other boats and potential hazards and to maintain a safe speed. By practicing these rules, you greatly reduce the chance that you'll be involved in an accident.
  - Developing a habit of wearing your life jacket also reduces the chance that you will drown should you find yourself in the water unexpectedly.
- Below is additional information to help you understand and minimize the risks associated with boating and make your time on the water safe and enjoyable.

## Increased Risk due to Boating Stressors

- The glare and heat of the sun, along with the motion of the vessel caused by the wind and the waves and the noise and vibration of the engine, have a large impact on your body that you may not even realize. These natural stressors make you tire more rapidly when on the water—regardless of your age or level of fitness. Many boaters greatly underestimate the effect these stressors have on fatigue.
- While perhaps not fatal themselves, stressors may weaken your body and mind enough to make the risk of an accident much greater.

## Increased Risk due to Dehydration

- A typical boating day in the summer causes your body to generate a large amount of heat. Sitting exposed in the sun increases your body heat. As you ride in a boat, your body automatically adjusts to the changing position of the boat. The exertion of this constant adjustment increases body heat.
- The way the body rids itself of increased heat is by sweating. Increased sweating will cause dehydration if fluids are not replaced. Dehydration will make you more fatigued and more at risk for a boating accident.
- The best way to minimize the risk of dehydration is to drink plenty of water—before, during, and after any water activities. A good rule of thumb while you are boating in warm weather is to drink some water every 15–20 minutes.
- Besides thirst, other signs of dehydration are a dry mouth, sleepiness, irritability, weakness, dizziness, and a headache. The first thing you should do if you experience any of these symptoms is to drink plenty of water. If possible, get out of the sun and rest. Serious dehydration may require medical attention.

## Profile of a Typical U.S. Boating Fatality

- Someone not wearing a PFD falls overboard and drowns **or...**
- A vessel capsizes and someone drowns **or...**
- A vessel strikes another vessel or fixed object, and the occupants are fatally injured or drown due to injuries.

Collisions often occur because boat operators are not staying alert and keeping a lookout for other boats or objects, or are going a little faster than they should. Although some collisions happen at night when it is difficult to see, many occur in daylight hours on calm, clear days. About one-third of the time, alcohol is involved.

You also might be surprised to learn that:

- Typically, victims drown even though there are enough life jackets on the boat. (Remember, you probably won't have time to put on your life jacket during an emergency. Get in the habit of wearing it.)
- The vessel is most often a small boat of open design, such as a jon boat, canoe, or other type of boat with low sides.
- The victims are usually men 26 to 50 years old, who have been boating for years and likely know how to swim.

## Remember...

It only takes one mistake to ruin your day of boating. Pay attention, slow down a little, and wear a life jacket!

## Accident Pyramid

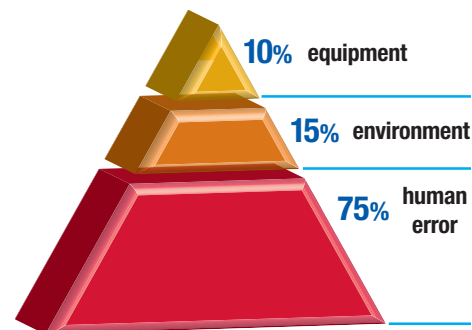

Most accidents are preventable. Even accidents attributed to the environment most likely could have been prevented if the operator had not overlooked the warning signals, had not made poor decisions, or had the proper boating skills. Many accidents attributed to equipment also could have been prevented if proper maintenance and defect detection had taken place.

## Rescue Technique

If you are on a dock when someone falls in, you should try to “talk” the victim to safety. If he or she is unable to get to the dock, you should:

**Reach:** Extend a fishing rod, branch, oar, towel, or other object to REACH out to the victim and pull him or her to safety. If nothing is available, lay flat on the dock and grab the victim’s hand or wrist, and pull him or her to safety.

**Throw:** If the victim is too far away to reach and a boat isn’t handy, THROW the victim a PFD or anything else that will float.



**Row:** If a rowboat is available, ROW to the victim and then use an oar or paddle to pull the victim to the stern. Let the victim hold onto the stern as you paddle to shore. If the victim is too weak, hold onto him or her until help arrives. If using a powerboat, stop the engine and glide to the victim from the downwind side.

**Go:** Swimmers without lifesaving training should not swim to a victim. Instead, GO for help. If you must swim, take along anything that floats to keep between you and the victim.

### Boater's Tip



Some people say they don’t wear their PFDs because they’re too hot or too bulky. But that’s not an excuse anymore. Inflatable PFDs offer a U.S. Coast Guard–approved life jacket that is small and lightweight. Inflatable life jackets come in two styles: a PFD that looks like a pair of suspenders or a belt pack that looks like a small fanny pack.

Some of these PFDs are designed to inflate if the wearer falls into the water; others require the wearer to pull a cord.

Inflatable PFDs are approved only for people 16 and older, and they are not to be worn on PWCs or while water-skiing.

Read the operating instructions and the approval label before you choose an inflatable PFD. Then be sure to wear it!

## Minimize Risk of Boating Accidents—Avoid Alcohol

- The effect of alcohol is increased by the natural stressors placed on your body while boating. Also, alcohol causes dehydration of your body. It takes less alcohol, combined with stressors, to impair an operator’s ability to operate safely. Research has proven that one-third of the amount of alcohol that it takes to make a person legally intoxicated on land can make a boater equally intoxicated on the water.
- Alcohol depresses the central nervous system, affects judgment, and slows physical reaction time. Most people become impaired after only one drink.
- Alcohol makes it difficult for you to pay attention and perform multiple tasks. For example, it will be more difficult for you to keep track of two or more vessels operating in your area. This could become critical if you are placed in an emergency situation and must make a sudden decision.
- Alcohol can reduce your ability to distinguish colors, especially red and green.
- Alcohol impairment increases the likelihood of accidents—for both passengers and vessel operators. Always designate non-drinking boaters to operate the vessel and to act as an observer if your group plans to consume alcohol. Do not allow your skipper to operate if he or she is drinking. Alcohol is a major contributor to boating accidents and fatalities.
- Drinking while boating is a choice. The best way to minimize the risk of an accident is to make the wise choice—**Don’t drink and boat!**

## Minimize Risk of Drownings—Wear PFDs (Life Jackets)

- Approximately 70% of all boating fatalities are drownings, and most of those fatalities could have been avoided. Ninety percent of drowning victims are not wearing a life jacket—drownings are rare when boaters are wearing an appropriate PFD. One of the most important things you can do to make boating safe and enjoyable is not only to carry enough life jackets for everyone on board but also to have everyone wear them!
- These requirements for PFDs are both important and the law.
  - *PFDs must be readily accessible.* Better yet, each person should wear a PFD because PFDs are difficult to put on once you are in the water. In most fatal accidents, PFDs were on board but were not in use or were not within easy reach. If you are in the water without a PFD, retrieve a floating PFD and hold it to your chest by wrapping your arms around it.
  - *PFDs must be of the proper size for the intended wearer.* Always read the label of a wearable PFD to make sure it is the right size based on the person’s weight and chest size. It’s especially important to check that a child’s wearable PFD fits snugly. Test the fit by picking the child up by the shoulders of the PFD and checking that his or her chin and ears do not slip through the PFD.
  - *PFDs must be in good and serviceable condition.*
    - Regularly test a PFD’s buoyancy in shallow water or a swimming pool. Over time, the ultraviolet radiation from the sun will break down the synthetic materials of your PFD. Frequently inspect PFDs for rips or tears, discolored or weakened material, insecure straps or zippers, or labels that are no longer readable. Discard and replace any PFD that has a problem.
    - If using an inflatable PFD, before each outing check the status of the inflator and that the CO<sub>2</sub> cylinder has not been used, has no leaks, and is screwed in tightly. Also check that the PFD itself has no leaks by removing the CO<sub>2</sub> cylinder and orally inflating the PFD. The PFD should still be firm after several hours. After an inflatable PFD has been inflated using a cylinder, replace the spent cylinder and re-arm it. Because an inflatable PFD is a mechanical device, it requires regular maintenance. Maintain the inflatable portion of the PFD as instructed in the owner’s manual.

## Boating Accidents

Most boating fatalities don't have anything to do with bad weather or hazardous sea conditions. They typically occur in smaller, open boats on inland waters during daylight hours when weather and visibility are good, the winds are light, and the water is calm. Despite these ideal conditions, passengers fall overboard and many boats capsize, causing over half of all boating fatalities.

### Capsizing, Swamping, or Falling Overboard

Capsizing is when a boat turns on its side or turns completely over. Swamping occurs when a boat stays upright and fills with water. Sometimes a person falling overboard from a boat causes the boat to capsize or swamp. Regardless, the outcome is the same—people are in the water unexpectedly.

- **To help prevent and prepare for capsizing, swamping, or someone falling overboard**, follow these guidelines.
  - Make sure that you and your passengers are wearing life jackets while the boat is underway.
  - Attach the engine cut-off switch lanyard to your wrist, clothes, or life jacket.
  - Don't allow anyone to sit on the gunwale, bow, seat backs, motor cover, or any other area not designed for seating. Also, don't let anyone sit on pedestal seats when operating at a speed greater than idle speed.
  - Don't overload your boat. Balance the load of all passengers and gear.
  - Keep your center of gravity low by not allowing people to stand up or move around while underway, especially in smaller, less-stable boats.
  - In a small boat, don't allow anyone to lean a shoulder beyond the gunwale.
  - Slow your boat appropriately when turning.
  - Don't risk boating in rough water conditions or in bad weather.
  - When anchoring, secure the anchor line to the bow, never to the stern.
- **If you should capsize or swamp your boat, or if you have fallen overboard** and can't get back in, *stay with the boat* if possible. Your swamped boat is easier to see and will signal that you are in trouble. Also signal for help using other devices available (visual distress signals, whistle, mirror).
  - If you made the mistake of not wearing a life jacket, find one and put it on. If you can't put it on, hold onto it. Have your passengers do the same.
  - Take a head count. **Reach, throw, row, or go**, if needed.
  - If your boat remains afloat, try to reboard or climb onto it in order to get as much of your body out of the cold water as possible. Treading water will cause you to lose body heat faster, so try to use the boat for support.
- **If your boat sinks or floats away**, don't panic.
  - If you are wearing a life jacket, make sure that it is securely fastened, remain calm, and wait for help.
  - If you aren't wearing a life jacket, look for one floating in the water or other floating items (coolers, oars or paddles, decoys, etc.) to help you stay afloat. Do your best to help your passengers find something to help them float and stay together.
  - If you have nothing to support you, you may have to tread water or simply float. In cold water, float rather than tread to reduce hypothermia.
- **If someone on your boat falls overboard**, you need to immediately:
  - Reduce speed and toss the victim a PFD—preferably a throwable type—unless you know he or she is already wearing a life jacket.
  - Turn your boat around and slowly pull alongside the victim, approaching the victim from downwind or into the current, whichever is stronger.
  - Stop the engine. Pull the victim on board over the stern, keeping the weight in the boat balanced, especially in small boats.

### Boater's Tip



Small craft boaters need to be especially careful to avoid falling overboard. Falling overboard and drowning is the major cause of fatalities for small boats. To prevent falling overboard:

Keep centered in the boat with your center of gravity low in the boat. Always keep your shoulders between the gunwales.

If possible, don't move about the boat. If you must move, maintain three points of contact. That is, keep both hands and one foot or both feet and one hand in contact with the boat at all times.

Evenly distribute and balance the weight of persons and gear within the boat, keeping most of the weight low. It is extremely important not to overload a small boat.



Sitting on the gunwale, bow, seat backs, or any other area not designed for seating is risky behavior and can result in falling overboard. It is illegal in many states (see Chapter 4).

### Remember...

Swimming to shore should be considered only as a last resort.

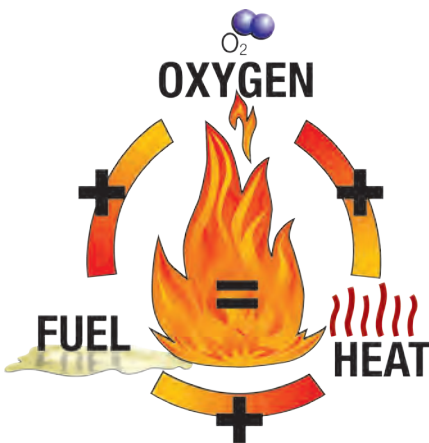

To prevent a fire emergency, don't mix the three ingredients that cause a fire to erupt: fuel, oxygen, and heat.



A vessel is grounded (runs aground) when it gets stuck on the bottom. Never assume that water is deep enough just because you are away from the shore. Also, don't presume that all shallow hazards will be marked by a danger buoy.

## Avoiding Collisions

A collision occurs when your boat or PWC collides with another vessel or with a fixed or floating object such as a rock, log, bridge, or dock.

- Collisions can cause very serious damage, injury, or even death. It is every vessel operator's responsibility to avoid a collision.
- **To prevent a collision**, boat and PWC operators should:
  - Follow the rules of navigation found in Chapter 3.
  - Pay attention to navigation aids.
  - Keep a sharp watch and appoint one person to be the "lookout."
  - Maintain a safe speed, especially in congested traffic and at night.
  - Look in all directions before making any turn.
  - Use caution if you are traveling directly into the sun's glare on the water.
  - Never operate when fatigued, stressed, or consuming alcohol.
  - Be aware that floating debris is more common after heavy rainfall.

## Dealing With Fire Emergencies

Many boats and PWCs have burned to the water line needlessly.

- **To help prevent a fire:**
  - Don't mix the three ingredients required to ignite a fire—fuel, oxygen, and heat.
  - Make sure ventilation systems have been installed and are used properly.
  - Maintain the fuel system to avoid leaks, and keep the bilges clean.
  - Follow the safe fueling procedures outlined in Chapter 2.
- **If fire erupts on your boat:**
  - If underway, stop the boat. Have everyone who is not wearing a PFD put one on in case you must abandon the boat.
  - Position the boat so that the fire is downwind.
    - If the fire is at the back of the boat, head into the wind. If the engine must be shut off, use a paddle to keep the bow into the wind.
    - If the fire is at the front of the boat, put the stern into the wind.
  - If the fire is in an engine space, shut off the fuel supply.
  - Aim the fire extinguisher at the base of the flames, and sweep back and forth (remember PASS).
  - Never use water on a gasoline, oil, grease, or electrical fire.
  - Summon help with your VHF marine radio.

## Running Aground

If you run aground while traveling at a high speed, the impact not only can cause damage to your boat but also can cause injury to you and your passengers.

- **Knowing your environment is the best way to prevent running aground.**
  - Become familiar with the locations of shallow water and submerged objects before you go out. Be aware that the location of shallow hazards will change as the water level rises and falls.
  - Learn to read a chart to determine your position and the water depth.
- **If you run aground, make sure no one is injured and then check for leaks.** If the impact did not cause a leak, follow these steps to try to get loose.
  - Don't put the boat in reverse. Instead, stop the engine and lift the outdrive.
  - Shift the weight to the area farthest away from the point of impact.
  - Try to shove off from the rock, bottom, or reef with a paddle or boathook.
  - Check to make sure your boat is not taking on water.
- If you can't get loose, summon help using your visual distress signals (see Chapter 4) or your VHF marine radio.

## Personal Injuries

Proper response to accidents results from good training and common sense. If an injury is minor, treat it immediately. If an injury is major, make the victim as comfortable and safe as possible until medical personnel arrive, assuming you have a way to call for help.

## Cold Water Immersion and Hypothermia

Cold water immersion kills in several ways. The colder the water, the greater the chance of death. However, the initial reaction to cold water immersion can occur in water as warm as 77° Fahrenheit. By understanding how your body reacts to cold water, you can prepare for and be better able to respond appropriately, thus increasing your chance of survival.

- There are four stages of cold water immersion.
  - **Stage 1: Initial “cold shock”** occurs in the first 3–5 minutes of immersion in cold water. Sudden immersion into cold water can cause immediate, involuntary gasping; hyperventilation; panic; and vertigo—all of which can result in water inhalation and drowning. Immersion in cold water also can cause sudden changes in blood pressure, heart rate, and heart rhythm, which can result in death.
  - **Stage 2: Short-term “swim failure”** occurs 3–30 minutes following immersion in cold water. The muscles and nerves in the arms and legs cool quickly. Manual dexterity, hand grip strength, and speed of movement all can drop by 60%–80%. Even normally strong persons can lose the strength necessary to pull themselves out of the water or even to keep their heads above water. Death occurs by drowning.
  - **Stage 3: Long-term immersion hypothermia** sets in after 30 minutes, at a rate depending on water temperature, clothing, body type, and your behavior in the water. Cold water robs the body of heat 25 times faster than cold air. Hypothermia occurs when your body loses heat faster than it produces it, cooling the organs in the core of your body. Hypothermia eventually leads to loss of consciousness and death, with or without drowning.
  - **Stage 4: Post-immersion collapse** occurs during or after rescue. Once rescued, after you have been immersed in cold water, you are still in danger from collapse of arterial blood pressure leading to cardiac arrest. Also, inhaled water can damage your lungs, and heart problems can develop as cold blood from your arms and legs is released into the core of your body.
- Your chance of surviving cold water immersion depends on having sufficient flotation to keep your head above water, controlling your breathing, having timely rescue by yourself or others, and retaining body heat.
- Prepare for boating in cold water conditions by always wearing a secured life jacket. Also wear layered clothing for insulation. Equip your boat with a means for re-entry (ladder, sling, etc.) to use if you should fall into the water.
- Of course, the best prevention is to take all measures necessary to avoid capsizing your boat or falling into cold water in the first place. If you do fall into or must enter cold water:
  - Don't panic. Try to get control of your breathing. Hold onto something or stay as still as possible until your breathing settles down. Focus on floating with your head above water until the cold shock response abates.
  - When your breathing is under control, *perform the most important functions first* before you lose dexterity (10–15 minutes after immersion).
  - If you were not wearing a PFD when you entered the water, look to see if one is floating around you and put it on immediately. Don't take your clothes off unless absolutely necessary. A layer of water trapped inside your clothing will help insulate you.

## Boater's Tip



Don't ever think that boating activities won't expose you to the risk of hypothermia. Wear rain gear when it rains. A windbreaker over a fleece jacket works very well to protect against the wind. Hypothermia can occur on what begins as a warm, sunny day. In remote areas, carry matches and go ashore if you need to build a fire. Also carry an extra jacket, hat, and blankets. Remember that, as a responsible operator, you should tell your passengers what to bring along for the outing.

## Stages of Cold Water Immersion

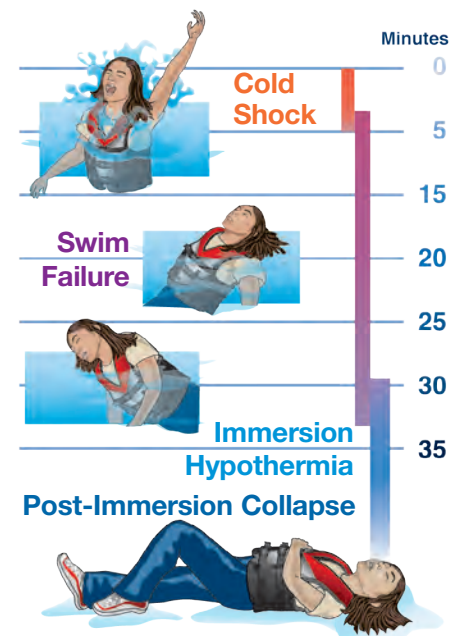

## Symptoms of Hypothermia

Learn to recognize the symptoms of hypothermia. They are listed here in order of severity.

1. Shivering, slurred speech, and blurred vision
2. Bluish lips and fingernails
3. Loss of feeling in extremities
4. Cold, bluish skin
5. Confusion
6. Dizziness
7. Rigidity in extremities
8. Unconsciousness
9. Coma
10. Death

## HELP Heat Escape Lessening Postures



This position protects the body's three major areas of heat loss (groin, head/neck, and rib cage/armpits). Wearing a PFD allows you to draw your knees to your chest and your arms to your sides.

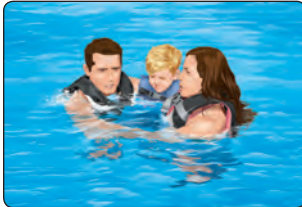

Huddling with other people in the water lessens the loss of body heat and is good for morale. Also, rescuers can spot a group more easily than individuals.

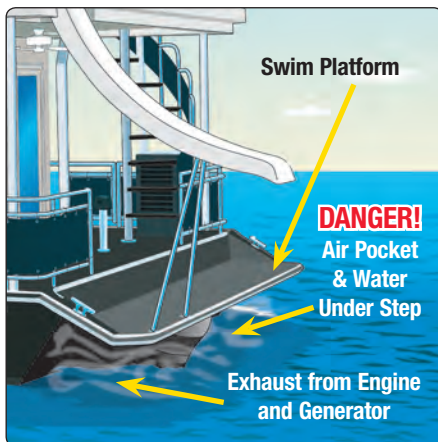

Swimmers should never enter an enclosed area under the swim platform—even for a second. One or two breaths of the air in this area could be fatal.



Natural air flows can suck fumes forward onto the vessel.

- Focus on locating and getting everyone out of the water quickly before you lose full use of your hands, arms, and legs. Try to reboard your boat, even if it is swamped or capsized, or anything else that is floating. Get as much of your body out of the water as possible. Even though you may feel colder out of the water, the rate of heat loss will be slower than if immersed in water.
- If you cannot get out of the water quickly, act to protect against rapid heat loss. In as little as 10 minutes, you may be unable to self-rescue. Your focus now should be to slow heat loss.
  - Stay as motionless as possible, protecting the high heat loss areas of your body, and *keep your head and neck out of the water*.
  - Safety typically looks closer than it actually is, so staying with the boat is usually a better choice than swimming.
  - Adopt a position to reduce heat loss. If alone, use the Heat Escape Lessening Posture (HELP) position; if there are others in the water with you, huddle together.
  - If you must swim, conserve energy and minimize movement. Swim on your back with your upper arms against the sides of your chest, your thighs together, and your knees bent. Flutter-kick with your lower legs.
- Be prepared at all times to signal rescuers.
- When treating victims of cold water immersion, you should:
  - Get the victim out of the water as soon as possible. Remove the victim from the water gently and in a horizontal position.
  - Prevent further heat loss.
  - Treat the hypothermia victim gently and to your level of training. Be prepared to provide basic life support.
  - Seek medical help immediately.

## Carbon Monoxide Poisoning

Carbon monoxide (CO) is an invisible, odorless, tasteless gas that is produced when a carbon-based fuel burns. CO can make you sick in seconds. In high enough concentrations, even a few breaths can be fatal. Sources of CO on your boat may include gasoline engines, gas generators, cooking ranges, and heaters.

- Early symptoms of CO poisoning include irritated eyes, headache, nausea, weakness, and dizziness. They often are confused with seasickness or intoxication. Move anyone with these symptoms to fresh air immediately. Seek medical attention—unless you're sure it's not CO.
- To protect yourself and others against CO poisoning while boating:
  - Allow fresh air to circulate throughout the boat at all times, even during bad weather.
  - Know where your engine and generator exhaust outlets are located and keep everyone away from these areas.
  - Never sit on the back deck, "teak surf," or hang on the swim platform while the engines are running.
  - Never enter areas under swim platforms where exhaust outlets are located—even for a second. One or two breaths in this area could be fatal.
  - Ventilate immediately if exhaust fumes are detected on the boat.
  - Install and maintain CO detectors inside your boat. Replace detectors as recommended by the manufacturer.
- Before each boating trip, you should:
  - Make sure you know where the exhaust outlets are located on your boat.
  - Educate all passengers about the symptoms of CO poisoning and where CO may accumulate.



## Carbon Monoxide Poisoning Situations

### Blocked Exhaust Outlets

can cause carbon monoxide to accumulate in the cabin and cockpit area.



### Another Vessel's Exhaust

that is alongside can emit carbon monoxide into the cabin and cockpit of your vessel. Your vessel should be at least 20 feet from a vessel that is running a generator or engine.



### Teak Surfing

or dragging or water-skiing within 20 feet of a moving vessel can be fatal. If persons are using a swim platform or are close to the stern, all gasoline-powered generators with transom exhaust ports must be off.

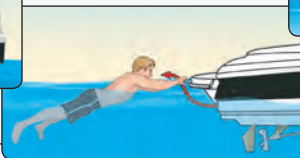

### Slow Speed or Idling

causes carbon monoxide to accumulate in the cabin, cockpit, and rear deck.

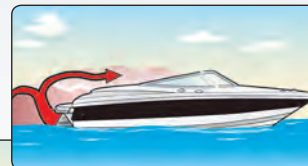

### Station Wagon Effect

causes carbon monoxide to accumulate inside the cabin and cockpit if you are operating the vessel at a high bow angle, if there is an opening that draws in exhaust, or if protective coverings are used when the vessel is underway.

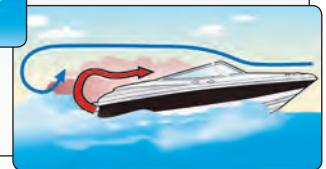

- Confirm that water flows from the exhaust outlet when the engines and generator are started.
- Listen for any change in exhaust sound, which could indicate an exhaust component failure.
- Test the operation of each CO detector by pressing the test button.
- At least monthly, you should:
  - Make sure all exhaust clamps are in place and secure.
  - Look for leaks from exhaust system components. Signs include rust and/or black streaking, water leaks, or corroded or cracked fittings.
  - Inspect rubber exhaust hoses for burns, cracks, or deterioration.
- At least annually, have a qualified marine technician check the engine and exhaust system.

## Responding to Other Serious Injuries

Here are some proper responses to accidents that can occur while boating.

- **Shock:** The seriously injured should be treated for shock by keeping the victim warm, still, and in a lying-down position until medical attention arrives. Elevate the feet several inches except in cases of head, neck, or back injury or hypothermia.
- **Bleeding:** Bleeding usually can be controlled by applying direct pressure to the wound. If the bleeding is minor, apply first aid. If it is serious, apply a dressing, maintain direct pressure, and seek medical attention.
- **Burns:** In cases of burns, the immediate goals are to relieve pain, prevent infection, and treat for shock. Immediately place minor burns in cold water and apply a dry bandage after the pain subsides. Seek medical attention for more severe burns.
- **Broken Bones:** Seek medical assistance immediately for broken and dislocated bones. Apply temporary splints with care. An improper splint can result in lifelong disfigurement; but lack of a splint can lead to hemorrhage, shock, or death.
- **Head, Neck, or Spinal Injury:** In cases of head, neck, or spinal injuries, never move a victim more than is absolutely necessary. The water can provide excellent support until medical personnel arrive. If a victim must be moved, place him or her gently on a firm, full-length support.

## First-Aid Kit



A responsible vessel operator takes a certified course in first aid and CPR. Doing so enables you to respond quickly in emergency situations and to provide immediate care until the victim can be treated by a physician. When out boating, it can take a long time to get medical help.

A responsible vessel operator also keeps a first-aid kit on board. It should be waterproof and include:

- ✓ An extra towel
- ✓ Antiseptic medications and lotions
- ✓ Aspirin or aspirin substitute
- ✓ Assorted gauze adhesive bandages and pads
- ✓ Cotton and cotton swabs
- ✓ Latex gloves
- ✓ Scissors

## Boater's Tip

To determine the distance you are from an approaching thunderstorm:

Count the number of seconds between the flash of lightning and the clap of thunder.

Divide the number of seconds by five.

The result is roughly the distance in miles you are from the storm.



## VHF-FM Stations for NOAA Weather Reports

NOAA Weather Radio broadcasts weather forecasts and warnings using these frequencies:

- 162.400 MHz
- 162.425 MHz
- 162.450 MHz
- 162.475 MHz
- 162.500 MHz
- 162.525 MHz
- 162.550 MHz

## Weather Warning Display Signals

Daytime  
Flags

Nighttime  
Lights



### Small Craft Advisory

Winds in the range of 21 to 33 knots (24 to 38 mph) create conditions considered dangerous to small vessels.



### Gale Warning

Winds are in the range of 34 to 47 knots (39 to 54 mph).



### Storm Warning

Winds are 48 knots (55 mph) and above. If winds are associated with a tropical cyclone, this warning signals winds of 48 to 63 knots.



### Hurricane Warning

Winds are 64 knots (74 mph) and above. This warning is displayed only in connection with a hurricane.

## Weather Emergencies

Weather can change very rapidly and create unexpected emergencies for boat and PWC operators. Even meteorologists have trouble predicting rapid changes in the weather. You should always watch for changes in the weather and monitor the weather forecast. As an operator, it is your responsibility to take appropriate action based on the weather.

### How to Avoid Severe Weather

- Tune a portable radio to a local station that gives weather updates. Listed in the sidebar are the VHF-FM radio stations that broadcast National Oceanic and Atmospheric Administration (NOAA) weather reports, which are updated each hour.
- Be alert to weather conditions. Accumulating dark clouds, shifting winds, and graying skies all may be indications of danger. Listen for distant thunder.
- Track changes in barometer readings. A rising barometer indicates fair weather. A falling barometer indicates foul weather is approaching.
- Watch for wind direction shifts, which usually indicate a weather change.
- Watch for lightning and rough water. If not electrically grounded, boats (particularly sailboats) are vulnerable to lightning.
- Be observant of weather from all directions; however, closely watch the weather to the west, the direction from which most bad weather arrives.
- Watch for fog that creates problems in inlets and bays. Typically, fog will form during the temperature changes of the early morning or evening hours and can persist for lengthy periods.
- Head toward the nearest safe shore if a thunderstorm is approaching.

### What to Do if Out in Severe Weather

- **Prepare the boat to handle severe weather.**
  - Slow down, but keep enough power to maintain headway and steering.
  - Close all hatches, windows, and doors to reduce the chance of swamping.
  - Stow any unnecessary gear.
  - Turn on your boat's navigation lights. If there is fog, sound your fog horn as instructed in Chapter 3.
  - Keep bilges free of water. Be prepared to remove water by bailing.
  - If there is lightning, disconnect all electrical equipment. Stay as clear of metal objects as possible.
- **Prepare your passengers for severe weather.**
  - Have everyone put on a USCG–approved life jacket (PFD). If a PFD is already on, make sure it is secured properly.
  - Have your passengers sit on the vessel floor close to the centerline. This is for their safety and to make the boat more stable.
- **Decide whether to go to shore or ride out the storm.**
  - If possible, head for the nearest shore that is safe to approach. If already caught in a storm, it may be best to ride it out in open water rather than try to approach the shore in heavy wind and waves.
  - Head the bow into the waves at a 45-degree angle. PWCs should head directly into the waves.
  - Keep a sharp lookout for other vessels, debris, shoals, or stumps.
  - If the engine stops, drop a “sea anchor” on a line off the bow to keep the bow headed into the wind and reduce drifting while you ride out the storm. In an emergency, a bucket will work as a sea anchor. Without power, a powerboat usually will turn its stern to the waves and could be swamped more easily.
  - If the sea anchor is not sufficient, anchor using your conventional anchor to prevent your boat from drifting into dangerous areas.

## Summoning Help

In times of serious boating emergencies, the ability to summon help quickly can make the difference between life and death. Here are some items that you should carry on board to help get assistance quickly.

- **Visual Distress Signals:** It is recommended that you have and know how to use the visual distress signals discussed in Chapter 4. Carry extras. Always respond immediately to other boaters displaying a distress signal.
- **VHF Marine Radio:** Consider purchasing a Very High Frequency (VHF) marine radio. VHF marine radios have channels that are reserved for distress calls and are monitored continuously by the U.S. Coast Guard (USCG).
  - VHF marine radios are increasingly popular with boaters for good reasons.
    - They save lives and are easy to use.
    - They are more effective for marine communications than CB radios or mobile phones. VHF radios have more consistent reception than mobile phones.
    - No license is needed when used in recreational boats.
    - They withstand rough weather.
    - Boat-mounted radios are wired to the boat's battery.
    - The source of a VHF signal can be located so that you can be found even in fog.
  - Operating a VHF radio takes some basic knowledge.
    - When operating your boat, you must monitor Channel 16 (the distress channel). If you hear a MAYDAY call, remain silent, listen, and write down information about the boat in distress. If the USCG or other rescue authority does not respond, try to reach the USCG while traveling toward the boat. If you cannot reach the USCG, assist the other boat to the best of your ability while not placing yourself or your passengers in danger.
    - If you have a life-threatening emergency, have everyone put on life jackets and issue a MAYDAY call on Channel 16.
    - Be aware that the distance for sending and receiving messages is limited by the height of the antenna and the power of the radio.
    - Always use the one-watt setting except in an emergency or if your signal is too weak to be received clearly.
    - Channel 16 is a calling and distress channel only and should not be used for conversation or radio checks. It can be used to make contact with another station (boat), but the communication then should move to a non-emergency channel such as 68 or 69. Penalties exist for misuse of a radio, including improper use of VHF Channel 16.
- **Mobile Phone:** If you own a mobile phone, include it as part of your standard boating gear. Keep a list of appropriate phone numbers on board.
  - Use it to call 911 or another water rescue authority in your area.
  - Mobile telephones may be useful for contacting local law enforcement agencies. However, they have serious limitations and should not be used as a substitute for a VHF radio.
- **Emergency Position Indicating Radio Beacon (EPIRB):** If you operate far from shore, you should seriously consider carrying appropriate communications gear. A satellite EPIRB is designed to quickly and reliably alert rescue forces, indicate an accurate distress position, and guide rescue units to the distress scene, even when all other communications fail.
- **Personal Locator Beacon (PLB):** A less expensive alternative to an EPIRB, the PLB sends out a personalized emergency distress signal to a monitored satellite system. It is waterproof and light enough for you to keep it attached to your life jacket at all times.

## VHF Marine Radio Channels

Here are the most commonly used channels on United States waters.

**Channel 6** Intership safety communications.

**Channel 9** Communications between vessels (commercial and recreational), and ship to coast (calling channel in designated USCG Districts).

**Channel 13** Strictly for navigational purposes by commercial, military, and recreational vessels at bridges, locks, and harbors.

**Channel 16** Distress and safety calls to Coast Guard and others, and to initiate calls to other vessels; often called the "hailing" channel. (Some regions use other channels as the hailing channel. For example, the Northeast uses Channel 9.) When hailing, contact the other vessel, quickly agree to another channel, and then switch to that channel to continue conversation.

**Channel 22** Communications between the Coast Guard and the maritime public, both recreational and commercial. Severe weather warnings, hazards to navigation, and other safety warnings are broadcast on this channel.

**Channels 24–28** Public telephone calls (to marine operator).

**Channels 68, 69, and 71** Recreational vessel radio channels and ship to coast.

**Channel 70** Digital selective calling "alert channel."

### Boater's Tip



To issue a MAYDAY call on Channel 16 of your VHF radio:

Transmit "MAYDAY, MAYDAY, MAYDAY."

Say "This is (name of vessel three times, call letters once)."

Repeat once more "MAYDAY" and your vessel's name.

Report your location.

Report the nature of your emergency.

Report the kind of assistance needed.

Report the number of people on board and condition of any injured.

Describe the vessel and its seaworthiness.

Wait for a response. If there is none, repeat the message.

### Pre-Departure Checklist

Before each trip, review a pre-departure checklist to make sure you have everything you need for a safe trip.

- ✓ Check the weather forecast for the area and timeframe during which you will be boating.
- ✓ Make sure the steering and throttle controls are operating properly.
- ✓ Check that all lights are working properly.
- ✓ Check for any fuel leaks from the tank, fuel lines, and carburetor.
- ✓ Check the engine compartment for oil leaks.
- ✓ Check hose connections for leaks or cracks, and make sure hose clamps are tight.
- ✓ Drain all water from the engine compartment, and be sure the bilge plug is replaced and secure.
- ✓ Make sure you have enough fuel or know where you can refuel.
- ✓ Check to be sure you have a fully charged engine battery and fire extinguishers.
- ✓ If so equipped, make sure the engine cut-off switch and wrist lanyard are in good order.
- ✓ Make sure that you have the required number of personal flotation devices and that they are in good condition.
- ✓ Leave a float plan with a reliable friend or relative.



Carefully explain all the important safety and operating points before allowing someone to operate your PWC. Never allow someone who is too young or too inexperienced, or who does not meet safety education requirements, to operate your PWC. See Chapter 4 for age and education requirements.

Powerboats, sailboats, and personal watercraft (PWCs) offer many opportunities for their operators to enjoy the waters. Along with the enjoyment comes responsibilities—both to the passengers and to others who share the public waterways.

### Responsibilities of a Vessel Operator

Sharing the fun of your vessel with your friends and family is all part of the boating experience. When you are operating a vessel, you have a responsibility to your passengers. You also are responsible when you let someone else drive your vessel. As the owner, you could be held liable for any damage caused by it, no matter who is driving at the time.

### Responsibility to Your Passengers

As the operator of a vessel, you are responsible for ensuring that your passengers understand basic safety practices and laws.

- Use a pre-departure checklist (see sidebar) to make sure you've taken the necessary safety precautions.
- Before departing, have a safety discussion with everyone on board. Some of the things you should point out are:
  - Locations of emergency equipment—life jackets (PFDs), fire extinguisher(s), visual distress signals, first-aid kit, and bilge pump
  - The need for all passengers to wear a PFD, especially during times of high vessel traffic, severe weather, or any other dangerous boating conditions
  - Laws about reckless operation, required equipment, and waste disposal
  - Safety procedures for responding to a fire or someone falling overboard
  - How to signal for help or use the VHF radio to make a MAYDAY call
  - How to anchor the vessel and handle lines (ropes)
- Conduct emergency drills with your passengers so that everyone knows what to do in case of a boating emergency.

### Responsibility to Others You Allow to Operate Your Vessel

You always should make sure that anyone operating your vessel understands his or her responsibilities as a driver and knows how to operate safely and responsibly.

- **Before allowing others to operate your vessel:**
  - Check that they meet the minimum age and boater education requirements for operation in your state (see Chapter 4).
  - Make sure they know basic boating safety and navigation rules.
  - Show them how to use the lanyard with the engine cut-off switch and require them to use it.
  - Explain the importance of obeying “idle speed,” “headway speed,” or “slow, no wake” restrictions.
  - Stress the need to keep a proper lookout for other boaters and hazards.
- **Before allowing others to drive your personal watercraft (PWC):**
  - Check that they meet the minimum age and boater education requirements for PWCs (see Chapter 4).
  - Tell them that they have the same responsibilities as other vessel operators.
  - If they are new to PWCs, have them practice in an uncrowded area first. While near shore, show how to start and reboard the PWC properly.
  - Be sure to explain how to steer and control the PWC. **Remind them to keep plenty of distance from other vessels and that power is required for steering control!**
  - Point out that it is easy to have so much fun that you forget to watch where you are going. Tell them to make sure the area is clear before making a turn.

## Responsibility to the Environment

While the effect of a single vessel on our rivers, lakes, and coastal waters may seem insignificant, multiply that impact by the millions of vessels on the waterways today. To preserve and protect the waters, wildlife, and aquatic vegetation enjoyed while boating, each person must be responsible.

- **Keep waterways clean and disease-free by disposing of waste properly.**
  - If your vessel is equipped with an installed toilet (marine sanitation device), make sure no sewage is discharged into the water. Empty the holding tanks only into pump-out stations.
  - Don't throw any litter overboard. Bring all trash back on shore to dispose of properly. Be sure to retrieve anything that blows overboard.
  - Fishing lines and plastics are deadly for fish and fowl and should never be discarded in the water or near shore.
  - Plastic six-pack holders can trap or strangle birds, fish, and other wildlife. Always properly dispose of these on land by snipping each circle of the holders with scissors.
  - Remember, if you have room to take it, you have room to bring it back!
- **Practice the three Rs—Reduce, Reuse, and Recycle.**
  - Many marinas provide facilities for recycling oil, aluminum, glass, and antifreeze. Use these services whenever possible.
  - Carry reusable items such as plates, silverware, cups, and glasses on board to reduce waste.
  - Recycle old fire extinguishers and marine batteries.
- **Protect the shoreline from erosion, and preserve aquatic vegetation.**
  - Reduce throttle to “no wake” speed when close to a shoreline or in small rivers to help prevent erosion.
  - Don't operate in shallow water where your prop or pump intake can stir up bottom sediments and destroy aquatic plants.
  - Drain the bilge and clean the prop before leaving a waterway. Failure to do so may transport plants or animals from one waterway to another and disrupt the natural balance of the environment.
- **Avoid using toxic substances on your vessel or around the water.**
  - Reduce the amount of detergent you use when cleaning your vessel. Use non-phosphate products, such as hydrogen peroxide, on your vessel. Don't use toxic cleaners.
  - Don't use toxic paints or other toxic products on your vessel. If you must use chemical products on your vessel, minimize their use while on the water.
  - Before the first use of your vessel in the spring, drain the antifreeze into a container and properly dispose of it on shore. Never use antifreeze containing ethylene glycol.
  - When fueling, don't top off the tank. Promptly mop up any fuel spills.

## Responsibility to Others Using the Waterways

As a vessel operator, you are just one of many who are enjoying the privilege of using the public waterways. It is your responsibility to stay aware of others in or on the water and to respect their use of the waterways. Remember that being a responsible operator includes controlling the noise of your boat or PWC.

### Did You Know?

Here are some common ways that boaters harm the environment.

- If you simply toss your trash into the water, it will be around for years. Here's the time it takes for some common items to decompose.



Paper takes 2–4 weeks. Wax-coated paper, such as a fast food wrapper or cup, takes much longer.



Tin cans take 100 years.



Aluminum cans take 200–500 years.



Plastic six-pack rings or any other plastic takes 450 years.



Glass bottles take more than 500 years.

- Small amounts of petroleum products spilled in the water can have a large impact.



One gallon of gasoline can contaminate 750 gallons of drinking water.



One single quart of oil when spilled can create an oil slick as large as three football fields and remain in the area for up to two years.



## Increase Your Safety and Fun With Paddling Instruction

Paddling a small craft is a skill best learned through hands-on training. Formal paddling instruction teaches you how to:

- Balance and stabilize your craft.
- Paddle efficiently.
- Exit and enter your craft on the water.
- Perform rescue and recovery.

### Boater's Tip

When participating in water activities that expose you to the water, such as paddling or windsurfing, consider both the water and the air temperature when deciding whether to wear a wetsuit or other cold water protective clothing.



## Understanding River Characteristics

- Rivers are constantly changing. It's up to you to be familiar with these changes.
- In a river without obstructions, the slowest moving water is near the bottom and the fastest is near the surface.
- Eddies are created behind an obstruction as water fills in the void created by the obstruction. The current behind an eddy is actually moving upstream. Skilled paddlers use eddies as a place to stop and rest.
- Hydraulics occur as water flows over an obstruction and a slight depression forms behind it. Downstream water attempts to fill this void, creating an upstream flow toward the obstruction. A low-head dam is a perfect and deadly example of a hydraulic. Avoid hydraulics altogether.

## Paddlesports—Canoes, Kayaks, and Rafts

Paddling down a river or across a lake or bay can be an enjoyable and safe activity. But, according to statistics, paddlers in small crafts, such as canoes, kayaks, and rafts, are more than twice as likely to drown as individuals operating other types of vessels.

This higher rate of fatalities can be attributed to two factors. First, paddlers don't consider themselves "boaters" and fail to follow the same safe practices as other small vessel operators. Second, many paddlers don't have the skills or knowledge they need to operate their small, unstable craft safely. They may be unaware of hazards unique to paddlesports, such as fast currents and low-head dams, or don't follow proper safety procedures when encountering them.

### ■ A paddler prepares for safety by doing the following.

- Always wear a life jacket (PFD), and know how to swim in a river current.
- Never paddle alone. Bring along at least one other boater. When canoeing, two canoes with two canoeists each are recommended. Three crafts with two paddlers each are even better. If unfamiliar with the waterway, paddle with someone who is knowledgeable about it.
- Never overload the craft. Tie down gear, and distribute weight evenly.
- Maintain a low center of gravity and three points of contact. Keep your weight balanced over the center of the craft.
  - Standing up or moving around in a small craft can cause it to capsize—a leading cause of fatalities among paddlers.
  - Leaning a shoulder over the edge of the craft also can destabilize it enough to capsize it.
- Stay alert at all times; and be aware of your surroundings, including nearby powerboats. Be prepared to react when dangerous situations arise.
- Practice reboarding your craft in the water with the help of a companion.
- Dress properly for the weather and type of boating.
- Check your craft for leaks.
- Map a general route and timetable when embarking on a long trip. Arrange for your vehicles to be shuttled to the takeout point.
- Know the weather conditions before you head out. While paddling, watch the weather and stay close to shore. Head for shore if the waves increase.

### ■ A paddle trip downriver can include these river hazards.

- *Low-head dams*: These structures are difficult to see and can trap paddlers. Consult a map of the river before your trip, and know where dams are located. Always carry your craft around them.
- *Rapids*: When approaching rapids, go ashore well upstream and check them out before continuing. If you see dangerous conditions, carry your craft around them.
- *Strainers*: These river obstructions allow water to flow through but block vessels and could throw you overboard and damage or trap your craft. Strainers may include overhanging branches, logjams, or flooded islands. Strainers are also notorious for causing death by drowning.

### ■ If you capsize, follow these guidelines.

- Float on the upstream side of your craft. You can be crushed on the downstream side if you run into an obstruction.
- Do not attempt to stand or walk in swift-moving water. The current could pull you under if your foot becomes trapped between submerged rocks.
- Float on your back with your feet and arms extended. Float with your feet pointed downstream to act as a buffer against rocks. Don't fight the current. Use the current to backstroke your way to shore.
- If the water is cold, take all necessary precautions to avoid hypothermia (see Chapter 5).

## Water-Skiing

Water-skiing, along with being towed on a tube, kneeboard, or similar device, is very popular with boaters. These activities are both fun and challenging; however, towing people on skis or other devices requires additional knowledge and skills.

### ■ Before towing a skier, the operator should:

- Have a second person on board to act as an observer (see Chapter 4).
- Review hand signals with the skier to ensure proper communication.
- Make sure the skier is wearing a U.S. Coast Guard–approved life jacket (PFD) designed for water-skiing. Keep in mind that ski belts are not U.S. Coast Guard–approved. A PFD with a high-impact rating is recommended. (See Chapter 4 for state-specific requirements.)
- Be familiar with the area and aware of any hazards, such as shallow water, rocks, or bridge pilings in the water.
- Make sure the tow lines are of the same length if towing multiple skiers.
- Never tow a skier at night. It is both hazardous and illegal.

### ■ While towing a skier, the operator should:

- Start the engine *after* making sure that no one in the water is near the propeller.
- Start the boat slowly until the ski rope is tight. When the skier is ready and there is no traffic ahead, take off in a straight line with enough power to raise the skier out of the water. Once the skier is up, adjust the speed according to the signals given by the skier.
- Keep the skier at a safe distance—at least twice the length of the tow rope—from the shoreline, docks, hazards, and people in the water.
- Avoid congested areas, beaches, docks, and swimming areas. Water-skiing takes a lot of room. Some areas may have designated traffic patterns.
- Maintain a sharp lookout for other vessels and obstructions in the water. Let the observer watch the skier.
- Always respond to the skier's signals. If you need to turn the boat, signal the skier of your intentions.
- Once the skier has dropped or fallen, circle the skier slowly either to return the tow line to the skier or to pick up the skier. Always keep the skier in view and on the operator's side of the boat. As an added precaution, display a red or orange skier-down flag under certain conditions. (See Chapter 4 for the water-skiing laws and requirements of your state.)
- To avoid propeller injuries, always shut off the engine *before* allowing the skier to board the boat. After the skier is on board, retrieve the tow line unless you are pulling another skier.

### ■ When in the water, the skier should:

- Wear a PFD. You never know when a fall will knock you unconscious.
- Learn to use hand signals (see sidebar).
- Never ski under the influence of drugs or alcohol. This is illegal and extremely dangerous because of the damage to your judgment and reflexes.
- Never spray swimmers, vessels, or other skiers. Such activity is illegal, dangerous, and discourteous.
- Never wrap any part of the tow rope around your body.
- Always hold a ski up out of the water after falling or after dropping the rope so that the boat operator and other vessels can see you.
- Never approach the back of the boat unless the engine has been shut off. Otherwise, you could be seriously injured by the boat's propeller.



### Hand Signals for Skiers

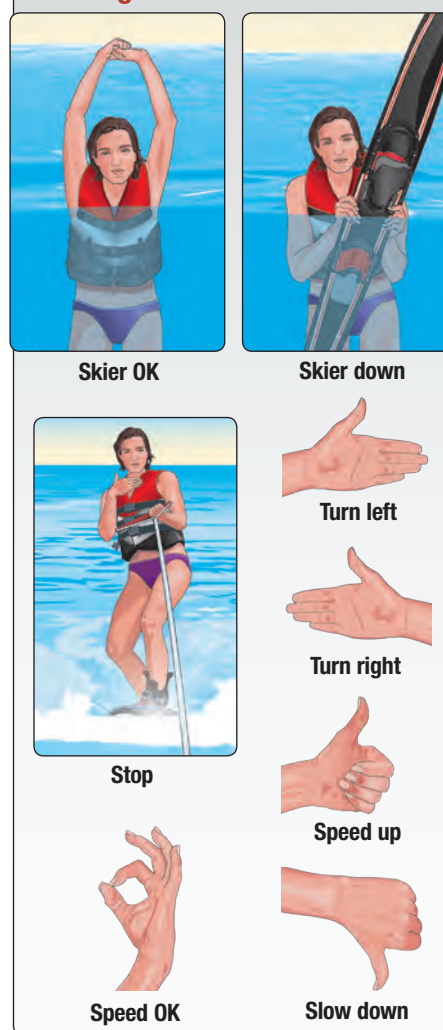

Some personal watercraft are capable of pulling water-skiers. Even if it's not required in your state, it is recommended that the PWC be rated for at least three people—the driver, the observer, and the retrieved skier. See Chapter 4 for the legal requirements in your state.



Both divers and vessel operators need to be aware of laws that affect this popular water sport.

### **furl**

To roll up tightly and make secure



Beginners should learn to windsurf from a qualified instructor when winds are light to moderate.

## Scuba Diving and Snorkeling

Diving is a popular sport, and divers can be found in areas shared with recreational boaters. As diving's popularity increases, it becomes more important for both boaters and divers to take special precautions. See Chapter 4 for the specific laws affecting divers and vessel operators in your state.

### ■ As a vessel operator, you should:

- Be able to recognize a diver-down flag, a red flag with a white diagonal stripe, floating in the area of the divers.
- Stay the legal distance away from a diver-down flag. (See Chapter 4 for the legal distance in your state.) Do not drive your vessel between a diver-down flag and a nearby shore.
- Watch out for divers surfacing when you see a diver-down flag. Bubbles may indicate that a diver is below.

### ■ For their own safety, divers should:

- Always display the diver-down flag and stay close to the flag.
- Use a stable boat that is suited for diving and anchor the boat securely.
- Avoid overloading the vessel with people, equipment, or supplies.
- Never dive or snorkel alone.

## Windsurfing

A growing water sport is windsurfing (or sailboarding). Windsurfers should:

- Dress appropriately.
  - Wear a life jacket (PFD).
  - Wear a wetsuit to avoid hypothermia.
- Tell someone where you are going and when you expect to return. Give this person instructions on what to do or whom to call in case you are overdue.
- Avoid becoming overly fatigued. One danger of windsurfing is falling off the board and being too exhausted to swim back to it. If you feel weak, **furl** the sail, lie stomach-down on the board, and stroke to shore.
- Always be on the lookout for vessels, avoiding them and their wakes. Remember, your sail can block your view of approaching vessels.
- If operating in open water, be careful not to stray too far from shore.

## Sailing

- It is always wise to give sailboats a lot of space. Sailboats are usually the stand-on vessel.
- Sailing has its own risks that require special care to avoid.
  - Small sailboats are prone to capsizing and swamping. Know how to right the sailboat if it capsizes, and carry a bailer on board.
  - Falling overboard is common. For that reason, sailors always should *wear* a life jacket (PFD).
  - Sailors should stay aware of the water temperature. Capsizing in the early spring, the fall, or the winter involves the risk of hypothermia.
- Those interested in sailing should take a certified course from organizations like the American Sailing Association or the U.S. Sailing Association.
- Here are some tips for safe sailing.
  - Stay off the water during storms or periods of high winds.
  - Carry a flashlight in case you remain on the water after dark. Shine the light on a sail to warn approaching vessels of your presence if you have no navigation lights or if another vessel does not see your navigation lights.
  - Remember that sailboats with an engine must have the red, green, and white navigation lights.
  - Remember that the mast can be a conductor for lightning. Be aware of masthead clearance when passing under power lines and bridges.



## Fishing

Fishing is the most popular activity among boaters. Anglers using vessels can be at risk. Unfortunately, anglers capsizing or falling overboard are common fatal boating accidents.

- Anglers who use vessels to fish need to think of themselves first as vessel operators. If you fish and boat, you should:
  - Know and follow all safe boating laws and requirements.
  - Pay attention to the capacity plate and not overload your vessel.
  - Wear a life jacket (PFD) especially when the water is cold or when fishing alone or in remote areas. (A wearable PFD is required in most competitive fishing tournaments.)
  - Recycle or toss used fishing line into receptacles on shore and not into the water or onto shorelines. Fishing line is not biodegradable and is dangerous to wildlife and propellers.
  - Take care of your fishing boat just like you do your fishing equipment.
- Vessel operators who are boating in the vicinity of fishing boats should:
  - Slow down when approaching fishing boats or give them a wide berth.
  - Never run over anglers' lines. Be aware anglers may have lines out to the sides of their boats or trolling behind them.
  - Never disturb fishing boats by making a large wake. An angler at anchor could be swamped by another vessel's cruising wake.

## Hunting

Many hunters use vessels for duck hunting or to get to their favorite hunting grounds. If you are using your vessel to hunt, you should:

- Understand that you are still responsible for obeying all boating laws and should follow all safe boating rules.
- Take extra precautions to avoid capsizing or swamping your vessel.
  - Be aware that small, flat-bottom vessels are prone to capsizing or swamping.
  - Keep weight low and distribute gear evenly in the vessel.
  - Do not exceed the vessel's capacity. Never crowd too many people or too much gear into one small hunting boat.
  - Take only well-trained dogs on board a small vessel. An excited dog could capsize a vessel easily. Keep the dog lying on the bottom, positioned in the center of the vessel.
  - Take precautions to avoid hypothermia in case you do capsize. See Chapter 5 for guidelines on preventing and treating this condition.
- Wear a life jacket (PFD) at all times while on the water. Wearable PFDs come in a variety of styles, including camouflage vests and float coats.
- Remember that cold water can be a killer. When hunting on cold water, dress in several layers under your PFD.
- Always check the weather and stay as close to the shore as possible.
- Never fire shots or release arrows until the vessel is stopped, the motor is turned off, and the vessel is secured or properly anchored. Always remain seated when shooting. Of course, you must possess a valid hunting license, tags, and permits for whatever you are hunting.
- Be aware of laws regarding transport of firearms in a vessel.
- Ensure that all firearms are always unloaded with the safety on and are secured in a gun case when they are being transported in a vessel.



If ill feelings between user groups become widespread, managing agencies may be forced to deal with the issue by closing down boating opportunities or by posting specific times for separate user groups. The best way to ensure better boating opportunities is for every boater to be courteous and responsible.

### Remember...

If you fish or hunt from a boat, you are not only an angler or a hunter but also a boater.



Special precautions and responsibilities are required when hunting from a vessel.



It is very important that you get in the habit of wearing a life jacket while fishing or hunting, especially in smaller boats and those with low gunwales. One simple mistake without a life jacket on could ruin a good day of fishing, not to mention ruin your life. Try out an inflatable life jacket to maximize comfort. And don't forget to wear your engine cut-off switch lanyard whenever the motor is running!

# Chapter Review Exercises

## Chapter 1

- The port side of a vessel is the \_\_\_\_\_ side.
- The stern of a vessel is the \_\_\_\_\_ of the vessel.
- Basic types of vessel hulls can be described as \_\_\_\_\_.
  - moving and non-moving.
  - displacement and planing.
  - rough and smooth.
  - narrow and wide.
- Name three basic hull shapes.
  - \_\_\_\_\_
  - \_\_\_\_\_
  - \_\_\_\_\_
- What are the four length classes of vessels?
  - \_\_\_\_\_
  - \_\_\_\_\_
  - \_\_\_\_\_
  - \_\_\_\_\_
- List the four basic types of engines.
  - \_\_\_\_\_
  - \_\_\_\_\_
  - \_\_\_\_\_
  - \_\_\_\_\_
- Stern drive and inboard engines are \_\_\_\_\_.
  - marinized outboard engines.
  - specially designed and built engines.
  - automotive engines adapted for marine use.
  - jet drive engines.
- The U.S. Coast Guard considers personal watercraft to be \_\_\_\_\_.
- Personal watercraft are not subject to the laws and requirements of other vessels.
 

\_\_\_ True \_\_\_ False
- An \_\_\_\_\_ is a device used to pump and force water under pressure through a steering nozzle at the rear of the vessel.

## Chapter 2

- What information is displayed on the capacity plate of an outboard powerboat?
  - \_\_\_\_\_
  - \_\_\_\_\_
- List three things that should be included on your float plan before you embark on an extended outing.
  - \_\_\_\_\_
  - \_\_\_\_\_
  - \_\_\_\_\_

- Name three things that you should do while filling the fuel tank of your vessel.
  - \_\_\_\_\_
  - \_\_\_\_\_
  - \_\_\_\_\_
- A rule of thumb to prevent running out of fuel on a PWC is \_\_\_\_\_ out, \_\_\_\_\_ in, and \_\_\_\_\_ in reserve.
- If the combined weight of the vessel and its engine is more than \_\_\_\_\_ of the recommended load capacity of the trailer, you should get the next larger trailer.
- “Tongue weight” is the amount of the loaded trailer’s weight that \_\_\_\_\_.
- Two strong safety chains should be \_\_\_\_\_ to support the trailer’s coupler in case it becomes disconnected from the towing vehicle.
- Where should you prepare your vessel before launching it from the trailer?  
\_\_\_\_\_
- Name three engine maintenance tips.
  - \_\_\_\_\_
  - \_\_\_\_\_
  - \_\_\_\_\_

## Chapter 3

- If the wind or current direction is toward the dock, you should cast off the \_\_\_\_\_ first when leaving the dock.
- The \_\_\_\_\_ is required to take early and substantial action to avoid a collision by stopping, slowing down, or changing course.
- The stand-on vessel must \_\_\_\_\_ unless \_\_\_\_\_.

- If you are driving a powerboat or PWC and meet another powerboat or PWC head-on, you should keep to the \_\_\_\_\_.

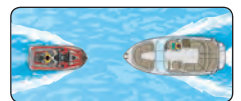

- If you are overtaking another vessel, you are the stand-on vessel.
 

\_\_\_ True \_\_\_ False

- If you see a red and a white light ahead when boating at night, you should maintain course and speed.
 

\_\_\_ True \_\_\_ False



7. If you see only a green light while boating at night, you may be approaching a \_\_\_\_\_ and you must \_\_\_\_\_.

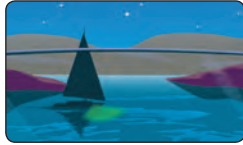

8. \_\_\_\_\_ are the “traffic signals” that guide boaters safely along their course.

9. The phrase “R\_\_\_\_\_ R\_\_\_\_\_ R\_\_\_\_\_” reminds vessels of the correct course in the lateral system of U.S. Aids to Navigation.

10. This buoy marks the edge of the channel on a boater’s \_\_\_\_\_ side when entering from the open sea or heading upstream.



11. This regulatory marker indicates \_\_\_\_\_.



12. This regulatory marker indicates areas that are \_\_\_\_\_ to vessels.

13. A good rule of thumb is that the anchor line should be at least \_\_\_\_\_ times the depth of the water.

14. You should never anchor from the \_\_\_\_\_ of the vessel as that can make the vessel unstable.

15. To maintain steering control of a PWC, you must never allow the engine to \_\_\_\_\_ or \_\_\_\_\_.

16. The most common complaints boaters have against PWC operators are \_\_\_\_\_ and \_\_\_\_\_.

17. As a courtesy to other boaters and people on shore, PWC operators should \_\_\_\_\_ their operating area.

18. Name a safety device that shuts the engine off if the operator is thrown from the proper operating position.  
\_\_\_\_\_

19. To avoid propeller strike accidents, make sure \_\_\_\_\_ when passengers are boarding or disembarking a boat.

### Chapter 4

1. The \_\_\_\_\_ is a number assigned and imprinted by the vessel manufacturer and is unique to your vessel.

2. Allowing passengers to ride on the \_\_\_\_\_ or \_\_\_\_\_ while underway is reckless operation.

3. If your blood alcohol concentration (BAC) is above the legal limit, it is illegal to \_\_\_\_\_ a vessel.

4. In order for a PFD to be legal, it must be \_\_\_\_\_-approved, in \_\_\_\_\_ condition, and \_\_\_\_\_ accessible.

5. Name the five types of PFDs.

- i. \_\_\_\_\_
- ii. \_\_\_\_\_
- iii. \_\_\_\_\_
- iv. \_\_\_\_\_
- v. \_\_\_\_\_

6. These Type \_\_\_\_ PFDs are \_\_\_\_\_ devices, and most states require at least one of these to be on board vessels 16 feet in length or longer.

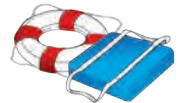

7. PWC operators, no matter what age, must wear an approved \_\_\_\_\_ whenever underway.

8. Fire extinguishers should be placed in an area that is \_\_\_\_\_ and not near the \_\_\_\_\_.

9. It is recommended that you wait at least \_\_\_\_\_ minutes after turning on your vessel’s blower (if so equipped) and before starting your engine.

10. For an 18-foot powerboat, required navigation lights include a red light on the \_\_\_\_\_, a green light on the \_\_\_\_\_, and \_\_\_\_\_.

11. A 16-foot canoe away from dock after dark must have on hand at least a \_\_\_\_\_ or \_\_\_\_\_.

12. Name two visual distress signals (VDSs) for use at night.

- i. \_\_\_\_\_
- ii. \_\_\_\_\_

13. Describe the appearance of a divers flag.  
\_\_\_\_\_

14. If an observer is on board when pulling a skier behind a vessel, the vessel should be rated to carry at least \_\_\_\_\_ people.

15. Water-skier(s) may be towed at night with proper lighting.  
\_\_\_\_ True \_\_\_\_ False

16. It is illegal to discharge \_\_\_\_\_, \_\_\_\_\_, or \_\_\_\_\_ into federally controlled or state waters.

17. You must report any accident you are involved in if it results in \_\_\_\_\_, \_\_\_\_\_, or \_\_\_\_\_.





## Chapter 5

- In a typical boating fatality, life jackets are \_\_\_\_\_ but are not \_\_\_\_\_.
- Name three boating stressors that make you tire more rapidly when on the water.
  - \_\_\_\_\_
  - \_\_\_\_\_
  - \_\_\_\_\_
- To prevent dehydration while on the water, you should drink some water at least \_\_\_\_\_.
- One-\_\_\_\_\_ of the amount of alcohol that makes a person legally intoxicated on land can be enough to make someone equally intoxicated when on the water.
- \_\_\_\_\_ is a major contributor to boating accidents and fatalities.
- An easy way to remember priorities for rescuing someone who has fallen into the water is \_\_\_\_\_, \_\_\_\_\_, \_\_\_\_\_, and \_\_\_\_\_!
- If you capsize, immediately swim to shore to ensure your safety.  
 True     False
- What are four things you should do if a fire erupts on your boat while underway?
  - \_\_\_\_\_
  - \_\_\_\_\_
  - \_\_\_\_\_
  - \_\_\_\_\_
- The condition called \_\_\_\_\_ occurs when the body loses heat faster than it can produce it.
- The primary danger that occurs immediately upon being immersed in cold water is \_\_\_\_\_.
- The position you should assume if trapped in cold water, "HELP," stands for:
 

H - _____	
E - _____	
L - _____	
P - _____	
- Name four symptoms of carbon monoxide poisoning.
  - \_\_\_\_\_
  - \_\_\_\_\_
  - \_\_\_\_\_
  - \_\_\_\_\_
- Bleeding usually can be controlled by applying \_\_\_\_\_ to the wound.

## Chapter 6

- As the operator of a vessel, you are responsible for ensuring that your passengers understand \_\_\_\_\_ and \_\_\_\_\_.
- Before allowing anyone to operate your PWC, you should remind them that power is \_\_\_\_\_.
- To protect the environment, you should practice the three "Rs"—R \_\_\_\_\_, R \_\_\_\_\_, and R \_\_\_\_\_.
- If you capsize in a canoe, kayak, or raft, you should stay on the \_\_\_\_\_ side of the craft.
- What are three river hazards that paddlers should avoid?
  - \_\_\_\_\_
  - \_\_\_\_\_
  - \_\_\_\_\_
- When picking up a skier, always keep them in view and on the \_\_\_\_\_ side of the boat.
- Identify the following water-skiing commands.
 

	i. _____
	ii. _____
	iii. _____
	iv. _____
- In addition to a displayed diver-down flag, what indicates that a diver may be below the water's surface?  
 \_\_\_\_\_
- When passing under power lines and bridges, sailboat operators need to be aware of the \_\_\_\_\_.
- Hunters who use vessels to get to their hunting spot should always wear their \_\_\_\_\_.

## Chapter 1

1. left
2. rear
3. b. displacement and planing.
4. i. Round bottom  
ii. Flat bottom  
iii. Vee bottom
5. i. Less than 16 feet  
ii. 16 to less than 26 feet  
iii. 26 to less than 40 feet  
iv. 40 to less than 65 feet
6. i. Outboard  
ii. Inboard  
iii. Stern drive  
iv. Jet drive
7. c. automotive engines adapted for marine use.
8. inboard vessels.
9. False
10. impeller

## Chapter 2

1. i. Capacity in pounds or number of people  
ii. Recommended maximum horsepower
2. i. Vessel's description: give number, size, make, etc.  
ii. Number, names, and addresses of passengers  
iii. Trip plan
3. i. Keep the nozzle in contact with the tank opening  
ii. Fill tank slowly and avoid spilling  
iii. Never fill to the brim
4.  $\frac{1}{3}$  out,  $\frac{1}{3}$  in, and  $\frac{1}{3}$  in reserve
5. 90%
6. presses down on the towing hitch.
7. crisscrossed
8. Well away from the boat ramp

9. • Keep well tuned  
• Check oil levels  
• Change oil  
• Check batteries  
• Grease and lubricate  
• Check for anything loose

## Chapter 3

1. stern line
2. give-way vessel
3. maintain its course and speed unless it becomes apparent the give-way vessel is not taking appropriate action.
4. right.
5. False
6. False
7. sailing vessel and you must give way.
8. Buoys and markers
9. Red Right Returning
10. left
11. danger.
12. off-limits
13. 7–10
14. stern
15. return to idle or shut off.
16. wake jumping and riding too close.
17. vary
18. Engine cut-off switch
19. the engine is shut off

## Chapter 4

1. Hull Identification Number
2. bow or gunwale
3. operate
4. U.S. Coast Guard–approved, in good and serviceable condition, and readily accessible.
5. i. Wearable Offshore life jacket  
ii. Wearable Near-shore vest  
iii. Wearable Flotation aid  
iv. Throwable device  
v. Special-use device
6. Type IV PFDs are throwable devices
7. life jacket (wearable PFD)
8. accessible and not near the engine.
9. four
10. red light on the port (left), a green light on the starboard (right), and a white light.
11. flashlight or lantern.
12. • Red flares  
• Red meteors  
• Electric light
13. Red flag with white diagonal stripe
14. three
15. False
16. waste, oil, or trash
17. death, serious injury, or significant property damage.

## Chapter 5

1. on the boat but are not being worn.
2. i. Glare and heat of the sun  
ii. Motion  
iii. Noise and vibration of the engine
3. every 15–20 minutes.
4. third

5. Alcohol
6. Reach, Throw, Row, and Go!
7. False
8. i. Stop the vessel and put on a life jacket  
ii. Keep fire downwind  
iii. Shut off fuel supply  
iv. Aim extinguisher at base of flames
9. hypothermia
10. involuntary gasping, resulting in water inhalation and drowning.
11. Heat Escape Lessening Posture
12. • Irritated eyes  
• Headache  
• Nausea  
• Weakness  
• Dizziness
13. direct pressure

## Chapter 6

1. basic safety practices and laws.
2. required for steering control.
3. Reduce, Reuse, and Recycle
4. upstream
5. i. Low-head dams  
ii. Rapids  
iii. Strainers
6. operator's
7. i. Skier down  
ii. Speed OK  
iii. Slow down  
iv. Turn right
8. Bubbles
9. masthead clearance.
10. life jackets (wearable PFDs).

# NOTES



State of <b>Nebraska</b>	<b>BOATING ACCIDENT REPORT</b>	<b>Game &amp; Parks Commission</b> 33-025 / rev. 8-01	
The operator of every vessel involved in a boating accident is required to file a written report in duplicate whenever a boating accident results in loss of life, loss of consciousness, medical treatment, or disability in excess of 24 hours or property damage in excess of \$500.00. Reports in death and injury cases must be made within 48 hours; reports in other cases are required within 5 days. All reports shall be submitted to the Nebraska Game and Parks Commission, PO Box 30370, Lincoln, NE 68503-0370. Any person failing to comply with these requirements is subject to a fine of \$100.00.			
<b>ACCIDENT DATA</b>		Accident No. _____	
DATE OF ACCIDENT	TIME _____ a.m. _____ p.m.	NAME OF BODY OF WATER	
LOCATION (Be precise)			
STATE	NEAREST TOWN	COUNTY	
<b>VESSEL NO. 1</b> (Your Boat)	BOAT NUMBER _____ HULL I.D. NO. _____	<b>VESSEL NO. 2</b> (Other Boat)	
OPERATOR _____ <small>LAST FIRST MIDDLE PHONE NO.</small>		OPERATOR _____ <small>LAST FIRST MIDDLE PHONE NO.</small>	
ADDRESS _____ <small>STREET OR RFD. CITY AND STATE ZIP CODE</small>		ADDRESS _____ <small>STREET OR RFD. CITY AND STATE ZIP CODE</small>	
DATE OF BIRTH _____ AGE _____ SEX _____		DATE OF BIRTH _____ AGE _____ SEX _____	
OPERATOR'S EXPERIENCE <input type="checkbox"/> Under 20 hours <input type="checkbox"/> 20 to 100 hours <input type="checkbox"/> 101 to 500 hours <input type="checkbox"/> Over 500 hours	FORMAL INSTRUCTION IN BOATING SAFETY <input type="checkbox"/> None <input type="checkbox"/> USCG Auxiliary <input type="checkbox"/> U.S. Power Squadrons <input type="checkbox"/> State <input type="checkbox"/> Other (Indicate)	OPERATOR'S EXPERIENCE <input type="checkbox"/> Under 20 hours <input type="checkbox"/> 20 to 100 hours <input type="checkbox"/> 101 to 500 hours <input type="checkbox"/> Over 500 hours	
		FORMAL INSTRUCTION IN BOATING SAFETY <input type="checkbox"/> None <input type="checkbox"/> USCG Auxiliary <input type="checkbox"/> U.S. Power Squadrons <input type="checkbox"/> State <input type="checkbox"/> Other (Indicate)	
TYPE OF BOAT <input type="checkbox"/> Open Motorboat <input type="checkbox"/> Cabin Motorboat <input type="checkbox"/> Auxiliary Sail <input type="checkbox"/> Sail (Only) <input type="checkbox"/> Rowboat <input type="checkbox"/> Canoe <input type="checkbox"/> Other _____	HULL MATERIAL <input type="checkbox"/> Wood <input type="checkbox"/> Metal <input type="checkbox"/> Fiberglass <input type="checkbox"/> Inflatable <input type="checkbox"/> Other _____	ENGINE <input type="checkbox"/> Outboard <input type="checkbox"/> Inboard Gasoline <input type="checkbox"/> Inboard Diesel <input type="checkbox"/> Inboard—Outdrive <input type="checkbox"/> Jet <input type="checkbox"/> Other _____ No. of Engines _____	
Length _____ Year Boat Built _____ Boat Make _____		Total Horsepower _____ Type of Fuel _____	
		Length _____ Year Boat Built _____ Boat Make _____	
		Total Horsepower _____ Type of Fuel _____	
NUMBER PERSONS ON BOARD (Include Skiers): _____ RENTED BOAT <input type="checkbox"/> Yes <input type="checkbox"/> No		NUMBER PERSONS ON BOARD (Include Skiers): _____ RENTED BOAT <input type="checkbox"/> Yes <input type="checkbox"/> No	
OWNER'S NAME, ADDRESS, TELEPHONE		OWNER'S NAME, ADDRESS, TELEPHONE	
ESTIMATED DAMAGE \$ _____ VESSEL #1		ESTIMATED DAMAGE \$ _____ VESSEL #2	
DESCRIBE DAMAGE TO VESSEL #1		DESCRIBE DAMAGE TO VESSEL #2	
WEATHER <input type="checkbox"/> Clear <input type="checkbox"/> Rain <input type="checkbox"/> Cloudy <input type="checkbox"/> Snow <input type="checkbox"/> Fog <input type="checkbox"/> Hazy	WATER CONDITIONS <input type="checkbox"/> Calm (Waves less than 6") <input type="checkbox"/> Choppy (Waves 6"-2') <input type="checkbox"/> Rough (Waves over 2'-6") <input type="checkbox"/> Very Rough (Greater than 6') <input type="checkbox"/> Strong Current	TEMPERATURE (Estimate) Air _____ °F. Water _____ °F.	WIND <input type="checkbox"/> None <input type="checkbox"/> Light (0-6 MPH) <input type="checkbox"/> Moderate (7-14 MPH) <input type="checkbox"/> Strong (15-25 MPH) <input type="checkbox"/> Storm (Over 25 MPH)
VISIBILITY Day <input type="checkbox"/> Good <input type="checkbox"/> <input type="checkbox"/> Fair <input type="checkbox"/> <input type="checkbox"/> Poor <input type="checkbox"/> Night			
OPERATION AT TIME OF ACCIDENT (Check all that apply — Boat 1 & 2)		TYPE OF ACCIDENT	
#1 #2 <input type="checkbox"/> Commercial Activity <input type="checkbox"/> Cruising <input type="checkbox"/> Maneuvering <input type="checkbox"/> Approaching Dock <input type="checkbox"/> Leaving Dock <input type="checkbox"/> Water Skiing <input type="checkbox"/> Racing <input type="checkbox"/> Towing <input type="checkbox"/> Being Towed	#1 #2 <input type="checkbox"/> At Anchor <input type="checkbox"/> Tied To Dock <input type="checkbox"/> Fueling <input type="checkbox"/> Fishing <input type="checkbox"/> Hunting <input type="checkbox"/> Skin Diving/ Swimming <input type="checkbox"/> Other (Specify)	<input type="checkbox"/> Grounding <input type="checkbox"/> Capsizing <input type="checkbox"/> Flooding <input type="checkbox"/> Sinking <input type="checkbox"/> Fire or Explosion (Fuel) <input type="checkbox"/> Fire or Explosion (Other than fuel) <input type="checkbox"/> Collision With Vessel <input type="checkbox"/> Collision with Fixed Object <input type="checkbox"/> Collision with Floating Object <input type="checkbox"/> Falls Overboard <input type="checkbox"/> Falls In Boat <input type="checkbox"/> Hit By Boat or Propeller <input type="checkbox"/> Fallen Skier <input type="checkbox"/> Other (Specify)	
WHAT IN YOUR OPINION CONTRIBUTED TO THE ACCIDENT? (Check all that apply — Boat 1 & 2)			
#1 #2 <input type="checkbox"/> Weather <input type="checkbox"/> Excessive Speed <input type="checkbox"/> No Proper Lookout <input type="checkbox"/> Overloading <input type="checkbox"/> Improper Loading <input type="checkbox"/> Restricted Vision <input type="checkbox"/> Hazardous Waters	#1 #2 <input type="checkbox"/> Alcohol Use <input type="checkbox"/> Drug Use <input type="checkbox"/> Fault of Machinery <input type="checkbox"/> Fault of Equipment <input type="checkbox"/> Operator Inexperience <input type="checkbox"/> Operator Inattention <input type="checkbox"/> Other (Specify)		
<b>OTHER PROPERTY DAMAGE INFORMATION</b>			
NAME & ADDRESS OF OWNER OF DAMAGED PROPERTY		Estimated Amount	DESCRIBE PROPERTY DAMAGE
		\$ _____	

**COMPLETE REVERSE SIDE**

FLOTATION DEVICES — LIFE JACKETS				FIRE EXTINGUISHERS	
Was your boat properly equipped with USCG-approved flotation devices/life jackets? <input type="checkbox"/> Yes <input type="checkbox"/> No		Were life jackets: Properly adjusted <input type="checkbox"/> Yes <input type="checkbox"/> No Properly sized <input type="checkbox"/> Yes <input type="checkbox"/> No		Was your vessel carrying NON-approved flotation devices? <input type="checkbox"/> Yes <input type="checkbox"/> No	
Were they accessible? <input type="checkbox"/> Yes <input type="checkbox"/> No				Were they accessible? <input type="checkbox"/> Yes <input type="checkbox"/> No	
Were they serviceable? <input type="checkbox"/> Yes <input type="checkbox"/> No				Were they used? <input type="checkbox"/> Yes <input type="checkbox"/> No	
Were they worn/used at time of accident? <input type="checkbox"/> Yes <input type="checkbox"/> No				If "YES," indicate kind:	
What type? <input type="checkbox"/> I <input type="checkbox"/> II <input type="checkbox"/> III <input type="checkbox"/> IV <input type="checkbox"/> V Specify: _____					
Include comments about PFD's or life jackets under ACCIDENT DESCRIPTION.					
<b>DECEASED or DISAPPEARED</b> . . . If more than (3) fatalities, use additional form(s).					
NAME	ADDRESS	DATE OF BIRTH	WAS VICTIM <input type="checkbox"/> Swimmer <input type="checkbox"/> Non-swimmer	DEATH CAUSED BY <input type="checkbox"/> Drowning <input type="checkbox"/> Other DISAPPEARED <input type="checkbox"/>	Was life jacket worn? <input type="checkbox"/> Yes <input type="checkbox"/> No What Type?
NAME	ADDRESS	DATE OF BIRTH	WAS VICTIM <input type="checkbox"/> Swimmer <input type="checkbox"/> Non-swimmer	DEATH CAUSED BY <input type="checkbox"/> Drowning <input type="checkbox"/> Other DISAPPEARED <input type="checkbox"/>	Was life jacket worn? <input type="checkbox"/> Yes <input type="checkbox"/> No What Type?
NAME	ADDRESS	DATE OF BIRTH	WAS VICTIM <input type="checkbox"/> Swimmer <input type="checkbox"/> Non-swimmer	DEATH CAUSED BY <input type="checkbox"/> Drowning <input type="checkbox"/> Other DISAPPEARED <input type="checkbox"/>	Was life jacket worn? <input type="checkbox"/> Yes <input type="checkbox"/> No What Type?
<b>INJURED</b> . . . If more than (3) persons injured, use additional form(s).					
NAME	ADDRESS	DATE OF BIRTH	NATURE OF INJURY		MEDICAL TREATMENT <input type="checkbox"/> Yes <input type="checkbox"/> No
NAME	ADDRESS	DATE OF BIRTH	NATURE OF INJURY		MEDICAL TREATMENT <input type="checkbox"/> Yes <input type="checkbox"/> No
NAME	ADDRESS	DATE OF BIRTH	NATURE OF INJURY		MEDICAL TREATMENT <input type="checkbox"/> Yes <input type="checkbox"/> No
<b>ACCIDENT DESCRIPTION</b>					
DESCRIBE WHAT HAPPENED (Sequence of events. Include failure of equipment. If diagram is needed, attach separately. CONTINUE ON ADDITIONAL SHEETS IF NECESSARY. Include any information regarding the involvement of alcohol and/or drugs in causing or contributing to the accident. Include any descriptive information about the use of life jackets.)					
<b>WITNESSES</b>					
NAME	ADDRESS			TELEPHONE Home: Business:	
NAME	ADDRESS			TELEPHONE Home: Business:	
NAME	ADDRESS			TELEPHONE Home: Business:	
<b>PERSON COMPLETING REPORT</b>					
SIGNATURE <b>X</b>	ADDRESS			TELEPHONE Home: Business:	
QUALIFICATION: <input type="checkbox"/> Operator <input type="checkbox"/> Owner <input type="checkbox"/> Investigator <input type="checkbox"/> Other			DATE SUBMITTED:		
<b>FOR REPORTING AUTHORITY REVIEW — Do Not Use — Use Agency Date Stamp</b>					
Causes based on (check one) <input type="checkbox"/> This report <input type="checkbox"/> Investigation and this report <input type="checkbox"/> Investigation <input type="checkbox"/> Could not be determined			Name of Reviewing Office		Date Received
Primary Cause of Accident					
Secondary Cause of Accident			Reviewed by		



# CONSERVING NEBRASKA'S NATURAL LEGACY

The mission of the Nebraska Natural Legacy Project is to implement a blueprint for conserving Nebraska's flora, fauna, and natural habitats through the proactive, voluntary conservation actions of partners, communities, and individuals.



The Natural Legacy Project is a collaborative effort between the state wildlife agency and the broader conservation community to address the needs of declining wildlife populations.

Conservation of Nebraska's biodiversity is a task larger than the resources of any one organization, community, or individual. The Natural Legacy Partnership Team is integral to selecting projects that advance Natural Legacy's mission.



© NEBRASKAland, used with permission

The regal fritillary (*Speyeria idalia*) is an at-risk butterfly of tall- and mixed-grass prairies. Its caterpillars need violets (*Viola* spp.) as a host plant to survive. Nebraska is in the heart of the range of regal fritillaries.

The Natural Legacy Project has developed effective partnerships that implement voluntary, incentive-based conservation actions for the benefit of at-risk and many common species. Ground-level habitat delivery is focused primarily in Biologically Unique Landscapes (BULs) and orchestrated by Coordinating Wildlife Biologists. These local biologists rely on collaboration with landowners and partners to accomplish large-scale habitat improvements across fence lines.

Natural Legacy's communication, collaboration, and education efforts reach out to multiple audiences. The conservation actions we take today will be sustainable only when the next generation embraces wildlife and habitat as valuable resources.

The Natural Legacy Project not only provides habitat to native wildlife but also offers numerous benefits to Nebraskans including fun, educational opportunities; incentive programs for landowners in BULs; and enhanced locations for hiking, hunting, fishing, birding, and paddling.

Nebraska Environmental Trust Board members and staff make the Nebraska Natural Legacy Project possible.

For more details on Natural Legacy, contact Kristal Stoner at [kristal.stoner@nebraska.gov](mailto:kristal.stoner@nebraska.gov).



© Melissa Panella, used with permission

Anthony works on his next big catch while enjoying the outdoors.



© NEBRASKAland, used with permission

North American river otters (*Lontra canadensis*) were once extirpated from Nebraska. Because of reintroduction and conservation efforts, they are increasing in number in the state.

# Boat Smart From the Start

Boating safety begins long before the vessel ever leaves the dock. When you leave for a day of boating, you seldom expect to end up in the water. But if you do and are not wearing your life jacket, you greatly increase your chances of becoming a boating statistic. Recent year averages indicate that approximately 90% of the people who died in vessel accidents were not wearing life jackets.



## NATIONAL SAFE BOATING WEEK

Remember that the National Safe Boating Week is always at the end of May. During this week, members of the National Safe Boating Council, including the Coast Guard Auxiliary, U.S. Power Squadrons, State Boating Law Administrators, Army Corps of Engineers, and other groups, will provide special programs on safe boating.

Information and "Wear It!" graphic provided by National Safe Boating Council



© U.S. Coast Guard, used with permission

## The Boating Safety Seven

1. Wear your life jacket.
2. Take a boating safety class.
3. Carry all required safety gear.
4. Know your boat and its limitations.
5. Follow the boating "rules of the road."
6. Be aware of weather and water conditions.
7. Boat sober, and be considerate of other boaters.



...it just makes sense

# Nebraska Required Equipment Checklist



	PWC	Boat Less Than 16 Ft.	Boat 16 Ft. to Less Than 26 Ft.
<b>Boating Safety Certificate On Board</b>	✓ <sup>1</sup>	✓ <sup>1</sup>	✓ <sup>1</sup>
<b>Certificate of Number On Board</b>	✓	✓	✓
<b>Validation Sticker Displayed</b>	✓	✓	✓
<b>Life Jacket (Wearable PFD): Type I, II, III, or V</b>	✓ <sup>2</sup>	✓	✓
<b>Throwable PFD: Type IV</b>		✓ <sup>5</sup>	✓
<b>Engine Cut-Off Switch</b>	✓		
<b>Type B-I Fire Extinguisher</b>	✓	✓	✓
<b>Backfire Flame Arrestor</b>	✓	✓ <sup>4</sup>	✓ <sup>4</sup>
<b>Ventilation System</b>	✓	✓	✓
<b>Muffler</b>	✓	✓	✓
<b>Horn, Whistle, or Bell</b>	✓	✓	✓
<b>Daytime Visual Distress Signals</b>			✓ <sup>5</sup>
<b>Nighttime Visual Distress Signals</b>	NA	✓ <sup>5</sup>	✓ <sup>5</sup>
<b>Navigation Lights</b>	NA	✓	✓
<b>Bailing Bucket</b>		✓	✓
<b>Paddle or Oar</b>		✓	✓ <sup>6</sup>

1. Applicable if operator is a minor.
2. Those on PWCs must wear a life jacket (wearable PFD) at all times.
3. A Type IV is required on all vessels with the exception of PWCs, canoes, or kayaks.
4. Required on inboard and stern drives only.
5. Required only if operating on federally controlled waters.
6. Not required on motorboats 26 feet or longer.

*Note: Some items are not applicable to PWCs since they are not allowed to operate between sunset and sunrise.*

# NEBRASKA GAME AND PARKS COMMISSION



**BOATING**



**FISHING**



**HUNTING**



**STATE PARKS**



**WILDLIFE**



Find out about...

- boat license renewal
- fishing and hunting permits
- places to boat, fish, and hunt
- state parks and trails
- education and outreach programs



[www.outdoornebraska.org](http://www.outdoornebraska.org)