



SIEMENS

Ingenuity for life

Consistent process
plant engineering
with COMOS Process
COMOS – Making data work.

siemens.de/comos



COMOS – Making data work.
Better quality decision-making throughout the plant's entire lifecycle



COMOS Process
Consistent process plant engineering



COMOS FEED
Controlled plant engineering from the outset



COMOS P&ID
Fast and easy generation of Piping and Instrumentation Diagrams

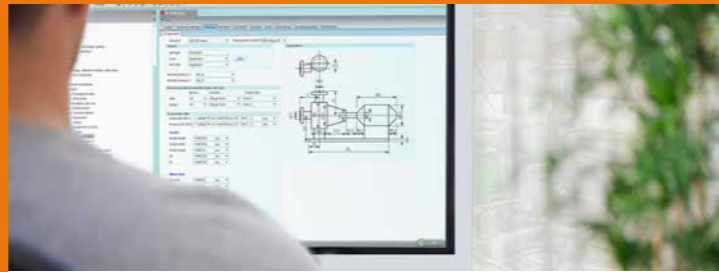

COMOS PipeSpec
Safely defining and managing pipes



COMOS Isometrics
Interactive generation of isometrics from construction to as-built status



COMOS 3D Integration
Integrated 3D engineering without media breaks

COMOS Solutions

COMOS – Making data work.

With COMOS, Siemens is the only company in the world to offer the process industry a software solution for the integrated management of plant projects – from engineering and operations to modernization as well as dismantling.

COMOS ensures that engineers and operators can access all project-relevant data at all times, across all company levels and in all project phases. COMOS offers a seamless flow of information by providing a common database. Because all data is always available and up-to-date, it depicts the actual as-built status of a plant at all times.

 Download our
Image Brochure

 Explore our
Business Value Calculator

How do **you** manage data?

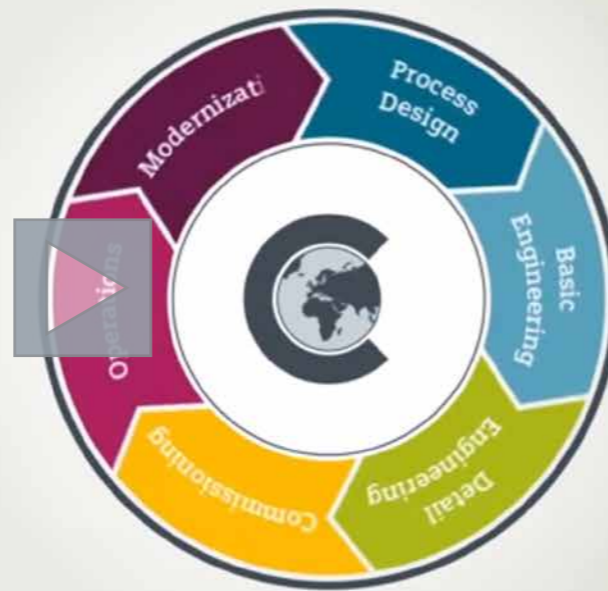

Global collaboration and interoperability with COMOS

This way, COMOS lays the foundation for greater reliability in decision-making and more efficient processes throughout the entire plant – for a lasting improvement in competitiveness.

All software solutions are integrated with each other and cover all lifecycle phases – from process design to basic and detail engineering to operation and modernization.

They can be individually implemented, as required, or employed as stand-alone solutions.

COMOS is based on a uniform database which provides all information in an object-oriented manner. The open software architecture facilitates optimum integration of third-party systems and allows for seamless integration in existing EDP landscapes.

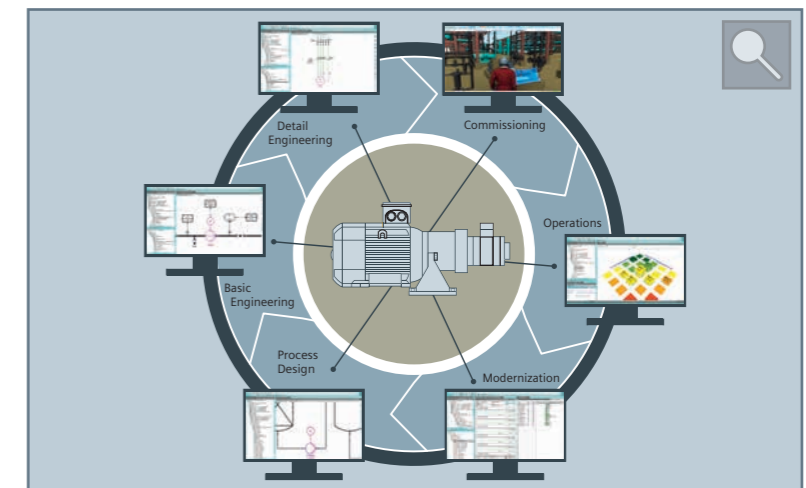

Object orientation in COMOS: All object specifications are available everywhere and at all times.





COMOS Process – Consistent process plant engineering

The early planning phase of a plant is particularly important from a financial point of view. At the start of engineering, in the front-end-engineering- and design phase (FEED), up to 80 % of the total costs of a plant project are defined. All decisions made during this phase strongly affect the subsequent planning steps as well as the safety, performance and cost efficiency of the entire plant.

Any errors occurring in this stage will pervade throughout the entire remainder of the planning phase if they are not remedied. This can result in time consuming and expensive corrections or possibly even damages to the plant or personal injuries.

Find all information about COMOS Process on the following pages.

-  To find out what advantages COMOS offers for your personal requirements, **click here** and you will reach our website with more information.
-  **Empower your data value** – Discover targeted, practical COMOS applications!



COMOS FEED – Controlled plant engineering from the outset

The front-end-engineering- and design phase (FEED) marks the beginning of plant engineering. COMOS FEED is the ideal solution for early reliable engineering.

An important task of the FEED phase is an initial cost calculation defined by preliminary assessment of all delivery items. It forms the basis for a binding cost estimate for the plant designer and serves as a guideline for the basic engineering. COMOS FEED enables the rough calculation of all costs even in this early engineering phase. Prices can be stored without problems and managed in clear table form.

Clear representation of processes

Entire processes can be displayed clearly and without problems in block diagrams to support the development of process flow diagrams.



COMOS FEED

COMOS P&ID

COMOS PipeSpec

COMOS Isometrics

COMOS 3D Integration

COMOS
Introduction

COMOS
Process

COMOS
Solutions



The flow direction as well as the relationship between the different processes is schematically represented by different symbols. Thus you always have an overview of all sub-processes and their contexts.

Intelligent and detailed display of process sequences

Process flow diagrams (PFDs) can be used for basic process engineering in COMOS FEED. The intelligent PFDs allow a new view of the process engineering model and make the enormous amounts of data more manageable. The different objects are automatically linked with all relevant information. All necessary data sheets and lists such as general plans, material information, etc. can be generated automatically. The standard documents can be easily and quickly adapted to meet the company requirements.

Increased efficiency in PFD creation

The creation of process flow diagrams is usually rather time-consuming since it is an elaborate task – objects must be positioned, flows must be placed and their direction must be defined. COMOS FEED offers a library with modules for structures and object combinations that are frequently used in the same way; you can copy, move and reuse these modules with drag&drop. Recurrent sequences can be standardized to individual requirements and recalled at any time. Process flow diagrams created for different plants are often similar in many points.



Process engineering with COMOS FEED

With COMOS FEED, PFDs that have been previously created can be copied, modified, and used again for a new project. This re-use of information results in significantly less time spent waiting and coordinating, and consequently presents major savings.

Easy integration of simulation data

An open interface model ensures greatest flexibility and data consistency during import and export of data. All data can be seamlessly integrated in the further engineering process, independently of the target system.

COMOS FEED enables the integration as well as the management of simulation data with cases and variants. The standard interfaces can be used to directly access the process data from different simulation programs. Data can be seamlessly imported and integrated into COMOS and can be used to create process flow diagrams in COMOS FEED. The simulation objects can be linked with PFD objects in COMOS. It is no longer necessary to manually transfer data, and possible sources of errors are eliminated. The quality of process data is always guaranteed.

Data security through individualized rules and review mechanisms

Efficient plant engineering can only be achieved through controlled planning processes. Rules can be easily defined and reviewed with the Knowledge Base in COMOS FEED. In this way, the planning engineer can create and apply comprehensive sets of rules for error-free creation of process flow diagrams. The review of rules only has to be triggered and will then continue automatically.

Different warning levels indicate deviations from the rule and their severity. This means the engineering process can be constantly controlled – any errors are detected early on and can be remedied as soon as possible. This approach reduces the time-consuming manual search for errors and increases the quality of the process design as early as during the FEED phase.

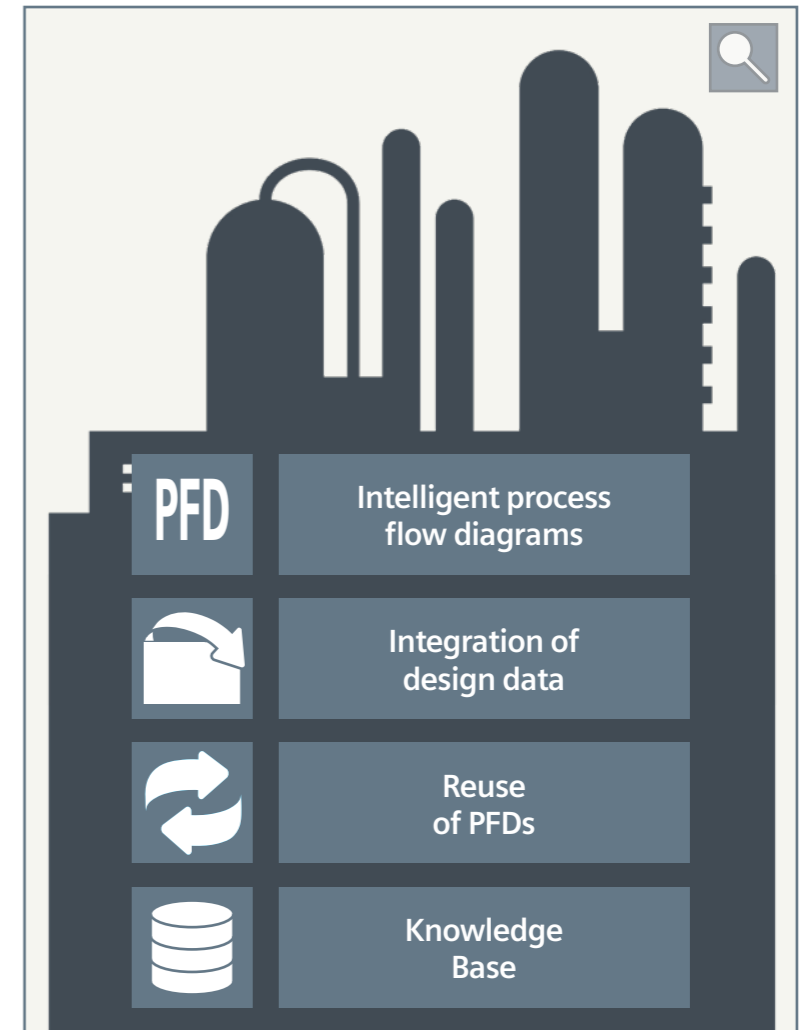

The functionalities of COMOS FEED at a glance

 Discover our successful **Project References**

COMOS FEED

COMOS P&ID

COMOS PipeSpec

COMOS Isometrics

COMOS 3D Integration

COMOS
Introduction

COMOS
Process

COMOS
Solutions



Your benefits with COMOS FEED at a glance:

- Reduced risk and error potential due to comprehensive review mechanisms
- Simplified integration of design data through interfaces to simulation programs
- Time and cost efficient PFD creation due to reuse
- Best data overview due to intelligent process flow diagrams
- Rough calculation of costs in the first engineering phase through the early and accurate provision of the foundation

COMOS FEED

COMOS P&ID

COMOS PipeSpec

COMOS Isometrics

COMOS 3D Integration

COMOS
Introduction

COMOS
Process

COMOS
Solutions





COMOS P&ID – Fast and easy generation of Piping and Instrumentation Diagrams

Many individual departments are involved in basic and detail engineering. This means that there are high demands for the software in this highly sensitive area. Data, devices and structures must be represented in a coherent, comprehensive and linked manner. The growing complexity of plants also increases the amount of data that has to be handled. There is a great risk of data loss at the interfaces – especially at the transitions between process, pipe and EI&C Engineering.

Data and information from the FEED phase can be seamlessly integrated into COMOS P&ID. Furthermore, COMOS P&ID offers an optimal connection to EI&C Engineering so that process-oriented and EI&C Engineering sequences can be mapped quickly and easily without data loss at the interfaces.

COMOS FEED

COMOS P&ID

COMOS PipeSpec

COMOS Isometrics

COMOS 3D Integration

COMOS
Introduction

COMOS
Process

COMOS
Solutions



COMOS P&ID is also linked with pipe engineering, isometry and 3D, maintenance and service areas so that there is consistency in all directions. COMOS P&ID is the data hub for all disciplines and departments and effectively supports plant engineers, installers and operators in their work. This results in less potential for errors, increasing productivity and reducing project lead times.

Comprehensive object libraries

A corresponding object is stored in the object library for each symbol in the Piping and Instrumentation Diagram (P&ID) in accordance with international standards. They are immediately available when you receive the software. You can use the symbols in industry-specific identification systems.

Intelligent connection technology

The P&ID automatically detects which connection parts are required and inserts them according to the correct flow direction. You do not have to check for correctness.

Ideal module management

You can create module libraries with COMOS P&ID. The reuse of plant components or sub-units and the simple handling results in significant savings for valuable engineering time.

Consistent pipe class management

The COMOS PipeSpec Manager lets you work with pipe classes as early as during P&ID creation. This means that you can carry out cost estimates and order procedures, if necessary, early in pipe engineering based on solid data.

Revision management with integrated tracking of changes

COMOS P&ID also enables a reliable revision management. All revisions can be stored and documented so that they can be viewed at a later time.

Import of databases and graphics

External software solutions can be embedded into existing software environments with minimal work and time. You can, for example, access PDS-2D data from COMOS and import this data, together with the associated graphic, into COMOS.

Proteus interface

You can use the integrated COMOS interface in accordance with Proteus standard (former XMpLant) to import and export data based on ISO 15926. Standardized data makes for easier data exchange with suppliers and other locations. Manual interventions or complex programming interfaces are not necessary and both the potential for errors as well as the required time is reduced dramatically during data exchange.

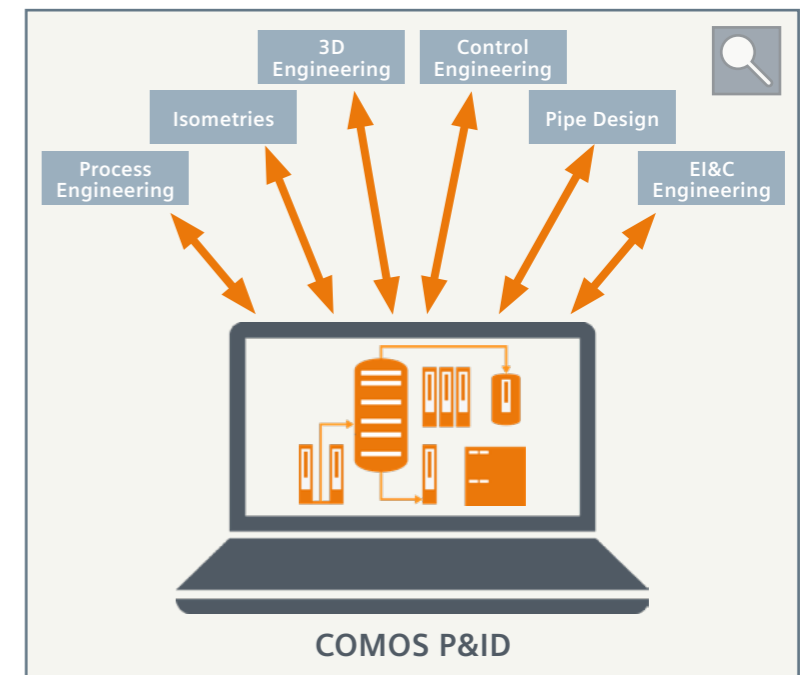

Your benefits with COMOS P&ID at a glance:

- Shorter process handling times due to bidirectional data flow
- Optimized project management through project engineering across locations and departments
- Increased efficiency with the use of industry standards across disciplines and departments
- Detection of inconsistencies starting in the early project phase
- Always current, adjusted data due to consistent and non-redundant data management
- Simple navigation and intuitive handling thanks to clear structure

COMOS FEED

COMOS P&ID

COMOS PipeSpec

COMOS Isometrics

COMOS 3D Integration

COMOS
Introduction

COMOS
Process

COMOS
Solutions



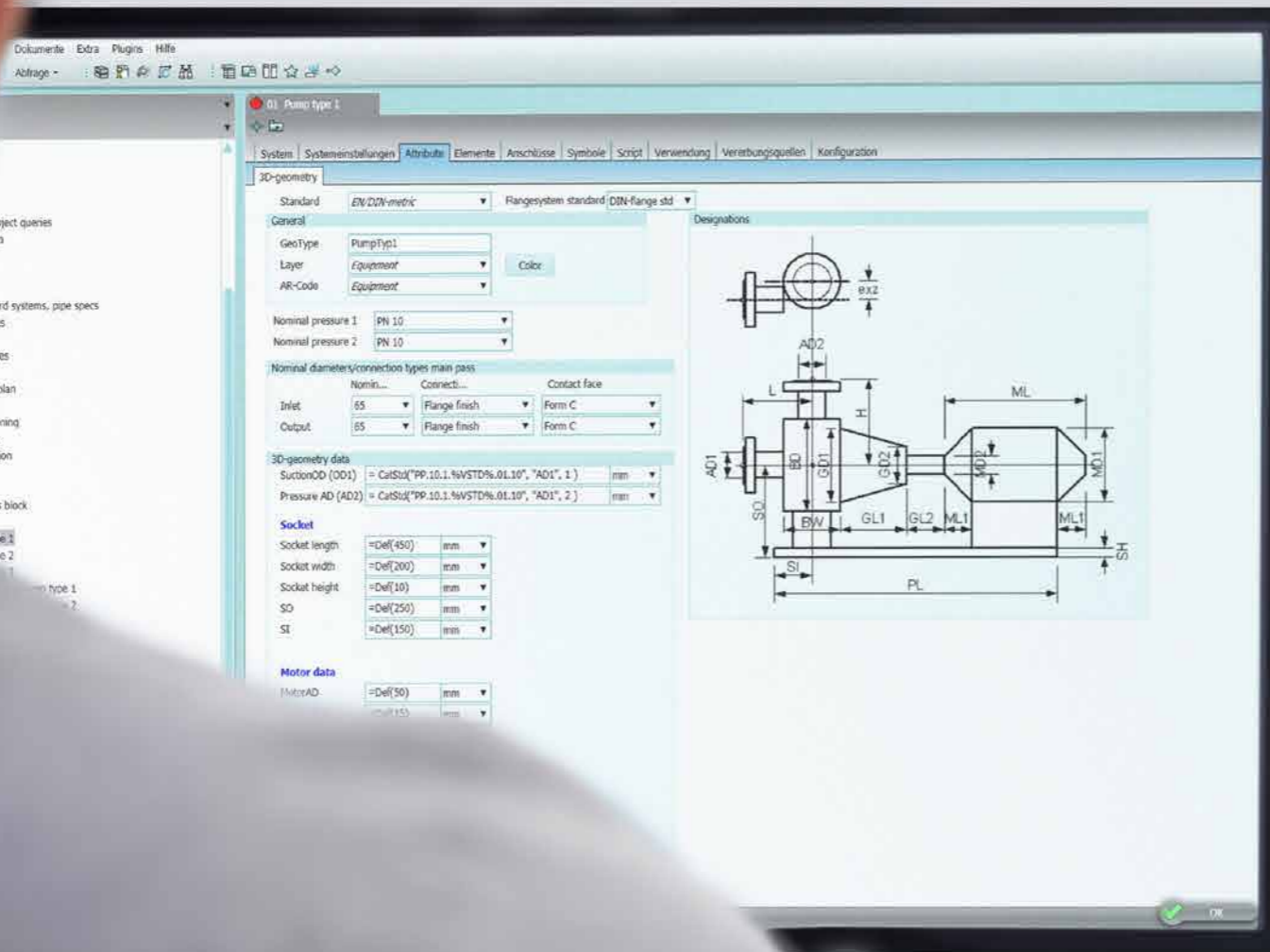

COMOS PipeSpec – Safely defining and managing pipes

If the necessary objects of the plant and the connections between them have been specified, the next planning step involves the specification of the connections – the pipes.

COMOS PipeSpec Designer is a solution to create and manage pipe specs. In a pipe parts catalog, based on approximately 450 geometry standards to DIN, ANSI, etc., more than 1,000 standard pipe components have been predefined and can be used for plant engineering.

Based on parameters such as material, pressure and temperature, components can be selected from a multitude of options and classified in pipe specs. You can also attach generic, configurable description texts for parts lists, order lists, etc. to the pipe specs to get a better overview.

If pipe part attributes are to be changed, the respective pipe spec is automatically updated using an inheritance mechanism.

COMOS FEED

COMOS P&ID

COMOS PipeSpec

COMOS Isometrics

COMOS 3D Integration

COMOS
Introduction

COMOS
Process

COMOS
Solutions



This completely eliminates the need for manual entry of pipe part or pipe spec data. Incorrect entries are not possible because all data comes from the pipe spec.

The pipe spec management guarantees quality-assured creation of 3D models and pipe isometrics because all pipe parts are defined by the respective pipe spec. The object orientation ensures consistency of all descriptions and specifications of the respective pipe regardless of which view it was created in. This means that you always get consistent data in all engineering phases.

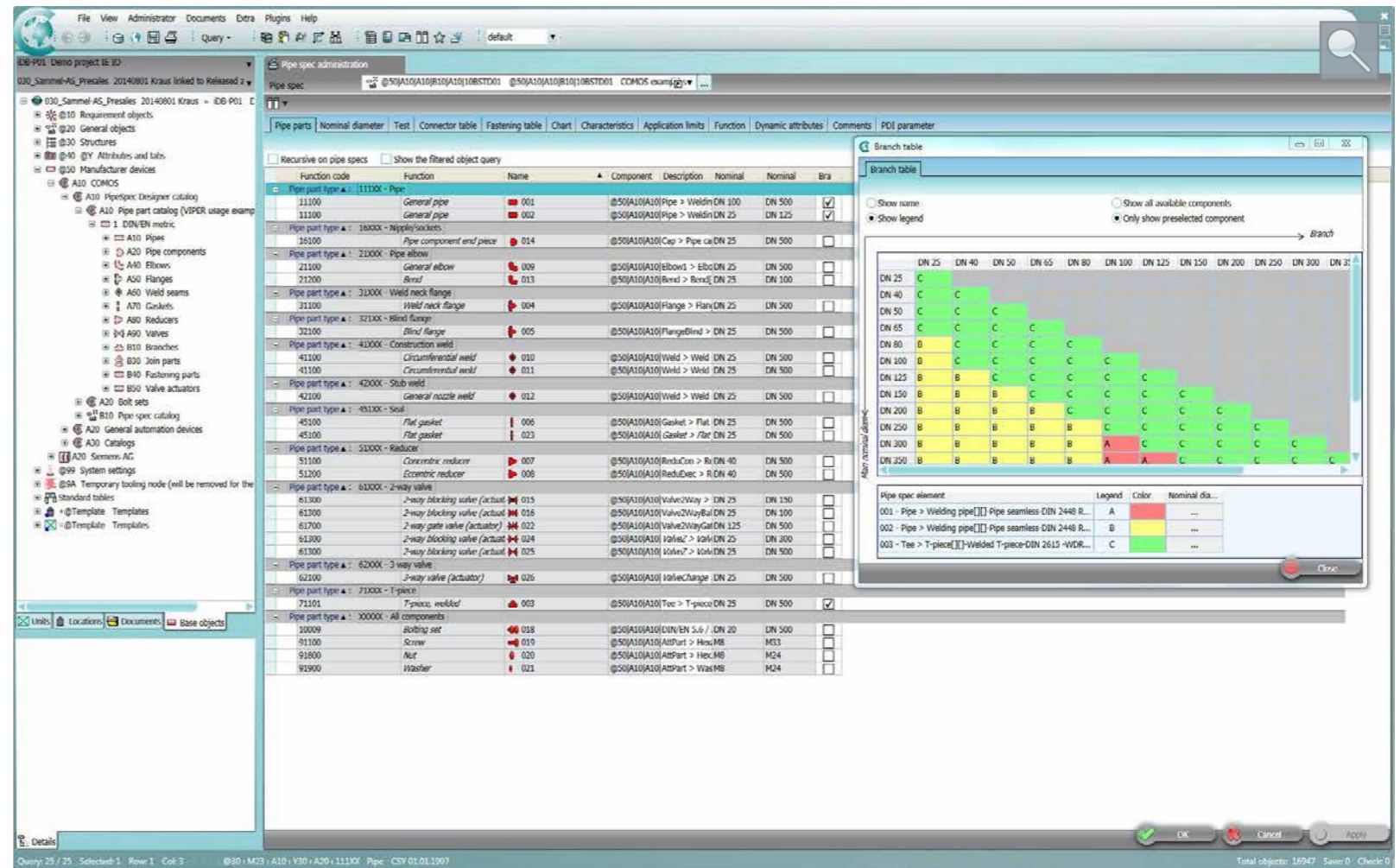

Efficient, table-assisted engineering of pipe branches

Discover our successful **Project References**

COMOS FEED

COMOS P&ID

COMOS PipeSpec

COMOS Isometrics

COMOS 3D Integration

COMOS Introduction

COMOS Process

COMOS Solutions



Your benefits with COMOS PipeSpec at a glance:

- User-friendly pipe engineering due to clear handling
- Versatile pipe parts catalog for quick and quality-assured pipe spec construction
- Reduced potential for errors due to the automatic update of pipe parts
- Quality assurance thanks to consistent use of pipe specs across all departments and disciplines

COMOS FEED

COMOS P&ID

COMOS PipeSpec

COMOS Isometrics

COMOS 3D Integration

COMOS
Introduction

COMOS
Process

COMOS
Solutions



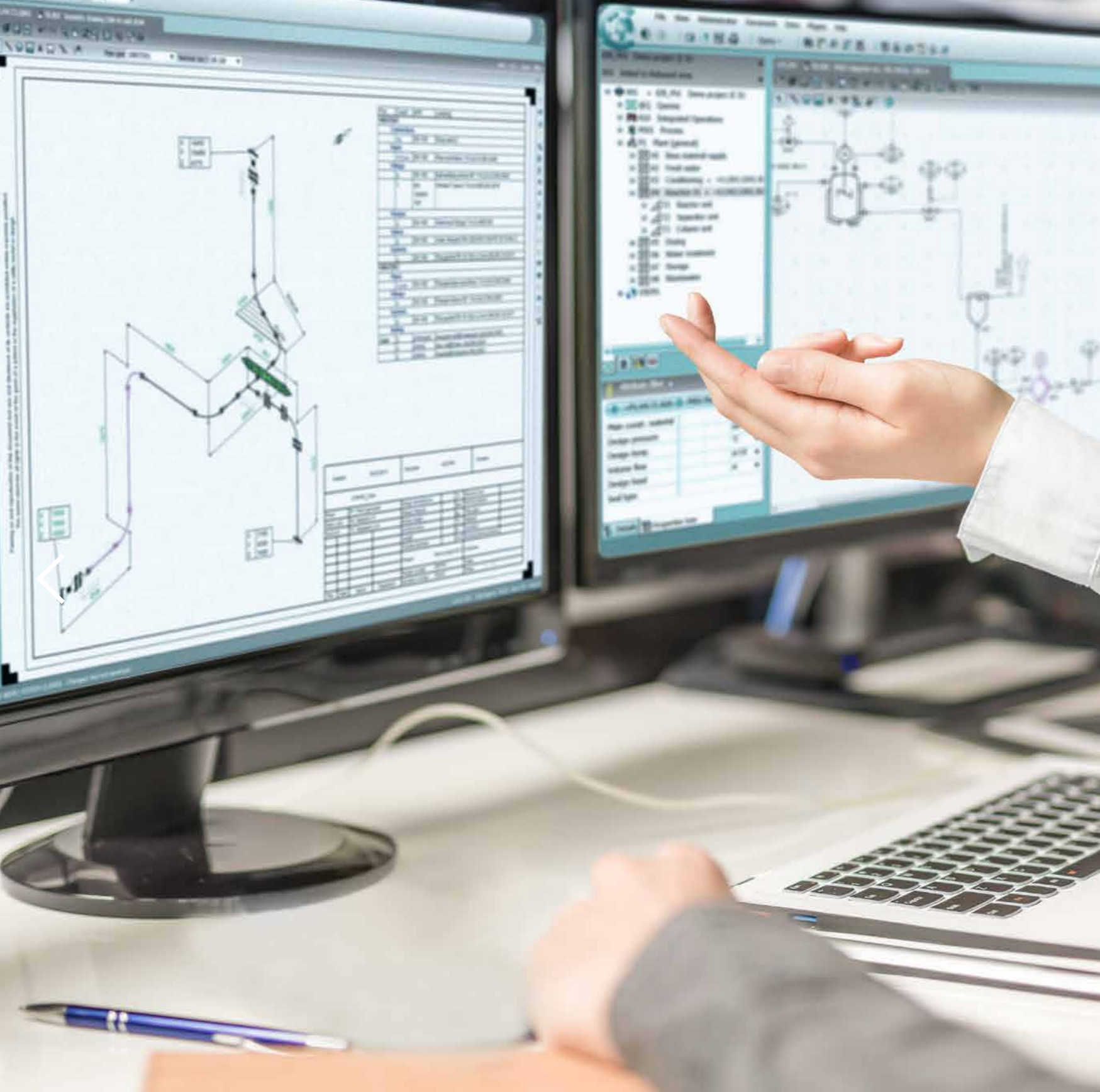

COMOS Isometrics – Interactive generation of isometrics from construction to as-built status

With COMOS Isometrics, a complete solution is available for interactive isometry creation based on a central database. This makes it the ideal solution to drastically reduce the error potential in the isometries area. Intelligent data transfer and support of different isometry types lets you work easily and with consistent data on a variety of engineering projects, such as planning new plants, reconstruction planning, inventories and inspections. They are also essential when determining maintenance points for maintenance of the plant during operation.

All required data from COMOS P&ID, COMOS PipeSpec or even COMOS 3D Integration can be integrated into and reused in COMOS Isometrics without problems. This is possible without media breaks thanks to object orientation.

COMOS FEED

COMOS P&ID

COMOS PipeSpec

COMOS Isometrics

COMOS 3D Integration

COMOS
Introduction

COMOS
Process

COMOS
Solutions



COMOS Isometrics is very simple to use: Objects can be positioned and moved on the user interface with drag&drop, while dimensions and geometry are automatically adjusted in the process. All pipe runs created in COMOS Isometrics can be controlled in the 3D model at any time, even during the operating phase. Interfaces to third-party systems as well as connections to accounting and measurement systems ensure effortless integration of external data.

Pipes can be divided or combined into suitable manufacturing sections (spools) for prefabrication and assembly. With a mouse click, spools can be conveniently created as an independent drawing including parts list. Cut and bending lengths are automatically detected in this process.

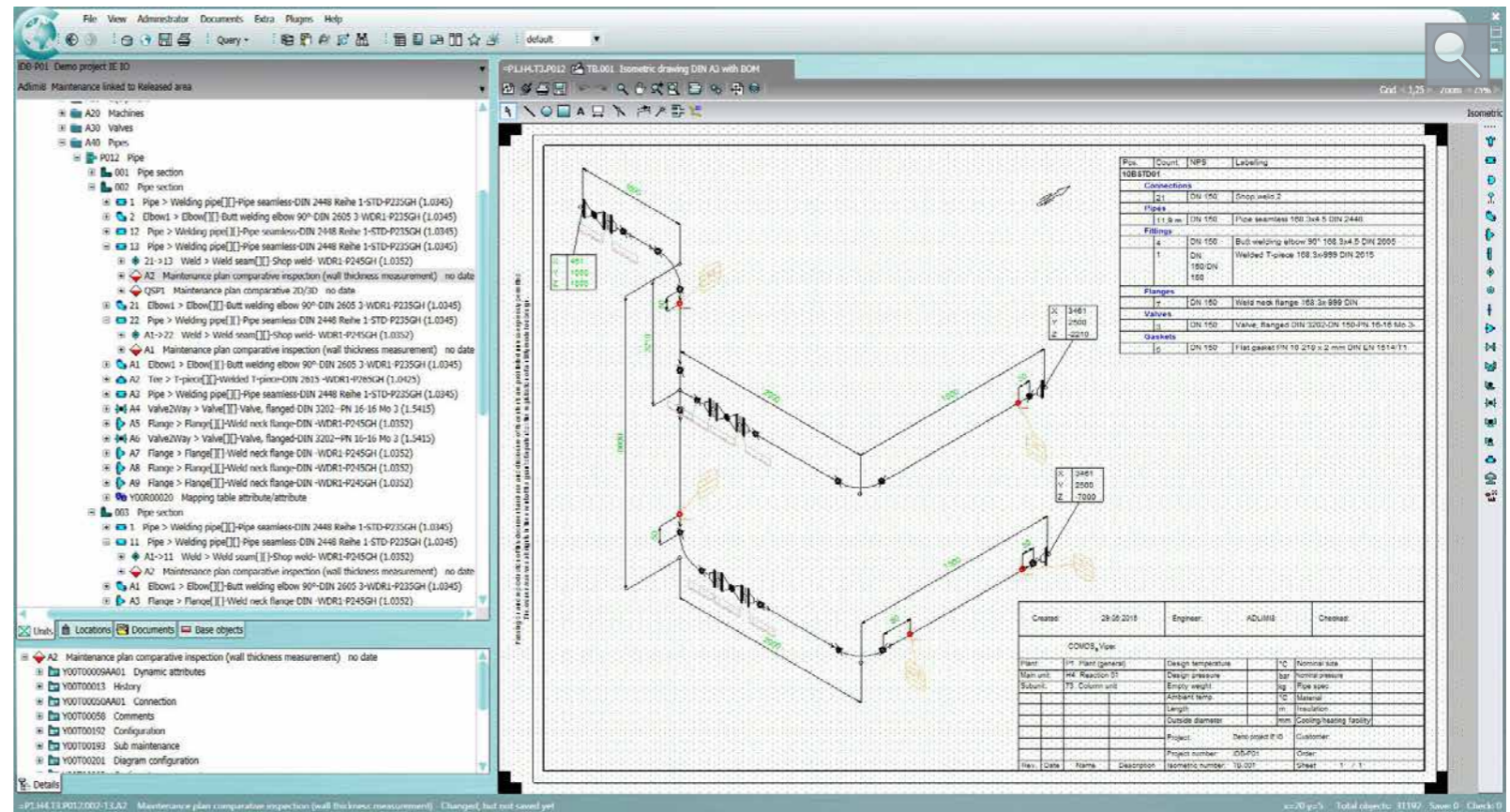

Easy positioning of test and maintenance points directly on the isometric drawing

Explore our **Business Value Calculator**

COMOS FEED

COMOS P&ID

COMOS PipeSpec

COMOS Isometrics

COMOS 3D Integration

COMOS
Introduction

COMOS
Process

COMOS
Solutions



Your benefits with COMOS Isometrics at a glance:

- Reliable isometry creation due to integrated data of pipe parts and pipe specs
- Simple operation due to intuitive user interface
- Flexibility due to data import from third-party systems
- Simple control in 3D model due to connection with COMOS 3D Integration

COMOS FEED

COMOS P&ID

COMOS PipeSpec

COMOS Isometrics

COMOS 3D Integration

COMOS
Introduction

COMOS
Process

COMOS
Solutions





COMOS 3D Integration – Integrated 3D engineering without media breaks

COMOS 3D Integration creates a secure connection between the individual COMOS software solutions and 3D tools and thus ensures the exchange of information.

The COMOS Engineering Adapter ensures a seamless connection of P&ID, isometry as well as 3D and the consistency of bidirectional data flow. The Engineering Adapter arranges the direct synchronization of process and construction data between P&ID and 3D engineering.

The software solution enables bidirectional engineering without media breaks between isometry and 3D engineering. Intelligent and interactive isometries can be directly derived from the 3D model. You can also transfer the modifications in the isometry directly to the 3D model.

COMOS FEED

COMOS P&ID

COMOS PipeSpec

COMOS Isometrics

COMOS 3D Integration

COMOS Introduction

COMOS Process

COMOS Solutions



Users can access the object-oriented pipe specs of COMOS using pipe spec-controlled menu bars. The connection material and its installation (e. g. counterflanges, gaskets, crews, etc.) are determined on the basis of rules. This simplifies detail engineering and greatly increases the quality.

COMOS Engineering Adapter for AVEVA PDMS / E3D

COMOS also offers an integration tool for Aveva PDMS and AVEVA E3D. Any engineering data created in COMOS can be optimally synchronized with the 3D model using the COMOS Engineering Adapter for AVEVA PDMS / E3D. Navigation between the two systems is very convenient, making it easy for the user to spot any inconsistencies between the two types of engineering. Time-consuming checks

are eliminated and the potential for errors is reduced.

Intelligent use of pipe specs and pipe parts catalogs

Standard-based and self-defined pipe specs and pipe parts catalogs from COMOS are automatically assigned to PDMS respectively E3D data. This means that pipe components in different nominal diameters are available in just a few steps for 3D processing. With COMOS, you can also manage pipe specs and pipe parts catalogs, including component geometries. This integration with the AVEVA 3D CAD tools reduces the potential for errors and ensures significant time savings for efficient 3D engineering.

Intelligent use of pipe specs and pipe parts catalogs

Using the Engineering Adapter, it is possible to generate Bentley "i-models" directly from the graphical and process data stored in the COMOS P&ID. The data container i-Model is based on the ISO 15926 standard. The information stored in it can be used seamlessly in OpenPlant for 3D design purposes, enabling inconsistencies to be avoided and project engineering work to be significantly accelerated. The interface ensures an always up-to-date "as built" representation of the plant.

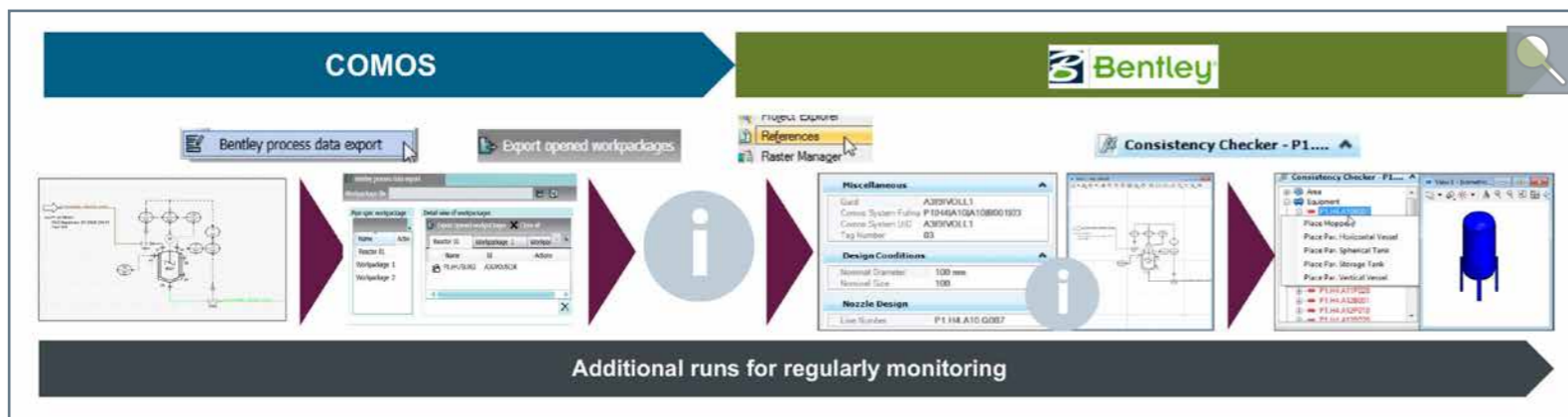

Interface between COMOS and Bentley OpenPlant

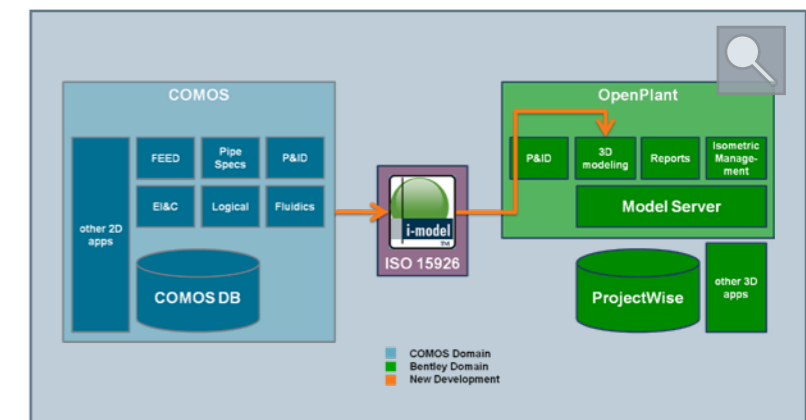

Workflow from COMOS to OpenPlant

COMOS FEED

COMOS P&ID

COMOS PipeSpec

COMOS Isometrics

COMOS 3D Integration

COMOS Introduction

COMOS Process

COMOS Solutions



Simplified material and parts list management

The material requirements details are documented in COMOS during the material management process. You can use this to conveniently generate your ordering requirements. You can include three types of material (estimated material, engineering

material and released material) from different sources (COMOS, Microsoft Excel, PDMS, etc.). You manage and release the material requirements and order lists with the help of revisions in COMOS. This means that you always have up-to-date and controlled material lists available, which increases reliability in the ordering process and results in greater efficiency

in plant engineering.

After the release of the 3D implementation, the material ordering can be executed immediately. As COMOS itself does not manage business or logistic information, an interface to ERP systems, such as SAP, has been set up.

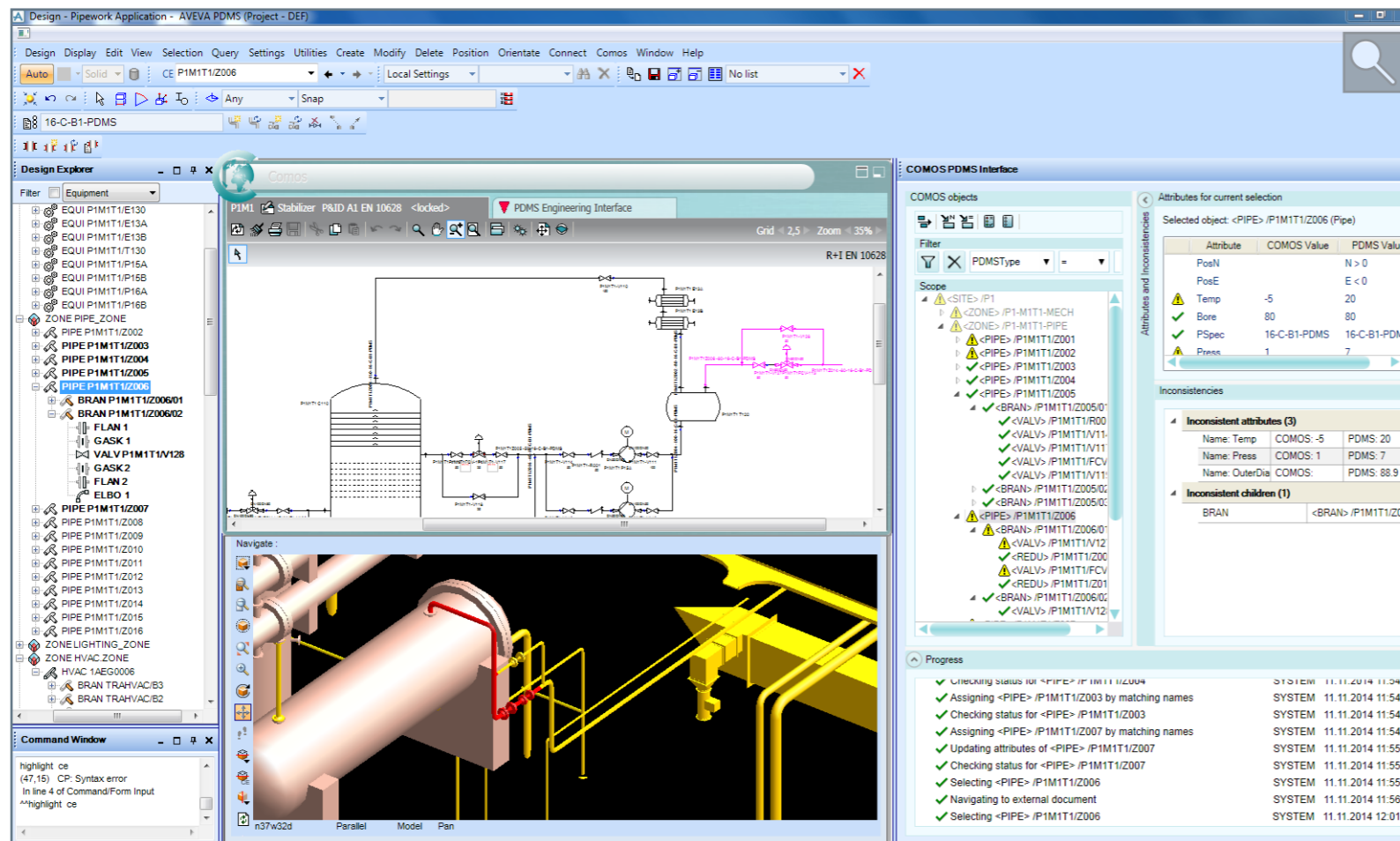

COMOS 3D Integration ensures the optimal 3D planning

Discover our successful
Project References

COMOS FEED

COMOS P&ID

COMOS PipeSpec

COMOS Isometrics

COMOS 3D Integration

COMOS
Introduction

COMOS
Process

COMOS
Solutions



Your benefits with COMOS 3D Integration at a glance

- Shorter engineering times due to convergence of P&ID, isometry and 3D
- Improved and secured plant documentation due to integration of all 3D layout documents and drawing derivations
- Error prevention due to data consistency in all supported disciplines and departments
- Improved quality due to rule-based determination of connection material
- Automatic material purchase order via an interface to ERP systems

COMOS FEED

COMOS P&ID

COMOS PipeSpec

COMOS Isometrics

COMOS 3D Integration

COMOS
Introduction

COMOS
Process

COMOS
Solutions



We look forward to your questions and suggestions! Please fill in the quick and easy contact form below, and one of our experts will be in touch soon.

First name*	
Last name*	
Company*	
Position*	
Street/no.	
Postal code/city	
Telephone	
E-Mail*	
Your message	

I hereby agree that my personal data will be used by Siemens and/or Siemens subcontractors exclusively in connection with the requested services. I herewith consent to any further disclosure of my personal data by Siemens Industry if such disclosure is mandatory by law or court judgement.*

* Required field

Submit

COMOS – Making data work. For you too!

We are quite certain that your plant data and information are the key to unlocking your potential. If you like to know why we are so sure about this, you should speak personally to one of our experts. Just get in touch with us. We are there for you at all times!

 **Visit our website**
siemens.com/comos

 **Integrated Engineering:
COMOS & SIMATIC PCS 7**
siemens.com/pcs7-paa

 **Follow us on YouTube**
youtube.com/siemens

 **Follow us on Twitter**
twitter.com/siemensindustry

Short and to the point

Object orientation in COMOS

In COMOS, all data relating to the same component (a pump, for example) form a unit – an object. Changes to object specifications are stored in the central COMOS database so that the updated data is available everywhere and at all times.

As-built status

As-built status is the term used to describe the actual status of a process plant at the present time. Because the COMOS database is always up-to-date, it can be accessed at any time using the system.

Open system architecture

COMOS' open system architecture provides an optimal framework for integrating third-party systems. The software can be adapted perfectly to operation-specific requirements and can be seamlessly integrated in existing IT landscapes. As a result, it makes a big contribution to the homogenization of a company's software applications.

Interoperability

Interoperability is the ability of mutually independent systems and technologies to smoothly collaborate by complying with common standards. Information can be efficiently provided without the need for specific intersystem arrangements. This facilitates quick and reliable worldwide decision-making around the clock.

DCC

Documents can be classified and sorted according to their properties with DCC (Document Kind Classification Code). In this way, they are not only available for the associated component, but can be called according to their properties - for example, all TÜV (German technical inspectorate) documents of the plant.

Case management

In case management, you can simulate the function of the plant in different operating situations, such as during start or in the case of maintenance. The plant can be optimized earlier by running tests with different parameters.

Media break

In relation to software solutions, a media break is a change of applications for information-processing. In the case of a media break, data needs to be transferred from one application to another and does not only exist once. Possible consequences are more work, wasted time and reduced quality.

Spools

A spool is a prefabricated pipe section. Based on isometry spool drawings, individual pipes can be joined almost completely automatically to form ready-to-use partial sections of the complete pipe run for installation in the field.



© Siemens AG 10/2018

Security information

In order to protect plants, systems, machines and networks against cyber threats, it is necessary to implement – and continuously maintain – a holistic, state-of-the-art industrial security concept. Siemens' products and solutions only form one element of such a concept. For more information about industrial security, please visit <https://www.siemens.com/industrialsecurity> .



Visit our website

[siemens.com/comos](https://www.siemens.com/comos)

