



iMac

Essentials

Contents

4 Chapter 1: iMac at a glance

- 4 Say hello to iMac
- 5 Take a tour
- 6 Connect accessories
- 9 Use an external display

10 Chapter 2: Get started

- 10 Set up
- 11 Find your way around
- 17 Unlock your iMac with Apple Watch
- 18 Quickly open apps
- 19 Multitask on your desktop
- 19 Access your content anywhere with iCloud
- 21 Use your iMac and iOS devices together
- 24 Apple Pay
- 25 AirDrop
- 25 AirPrint
- 26 AirPlay
- 27 Migrate your data
- 28 Save space on your iMac
- 29 Back up and restore

30 Chapter 3: Apps

- 30 Included apps
- 31 Safari
- 32 Mail
- 33 Notes
- 34 Messages
- 35 Calendar
- 36 Photos
- 37 iTunes
- 38 FaceTime
- 39 Maps
- 40 iBooks
- 41 Pages
- 42 Numbers
- 43 Keynote
- 44 iMovie
- 45 GarageBand
- 46 App Store

48	Chapter 4: Find answers
48	Mac Help
49	Common questions
50	Keyboard shortcuts
51	Replace memory
56	Chapter 5: Safety, handling, and support
56	Important safety information
58	Important handling information
59	Understanding ergonomics
60	FCC regulatory compliance
60	Canadian regulatory compliance
61	EU compliance statement
61	ENERGY STAR® Compliance Statement
62	Apple and the environment
62	Regional disposal and recycling information
62	Software License Agreement

iMac at a glance

1

Say hello to iMac



This guide provides the essential information you need to get the most from your iMac. The sections described below cover the hardware features, the software setup process and highlights, what you can do with apps on your Mac, and how to find more information on any topic.

Take a look around. Want a quick intro to the features (ports, connectors, accessories) of your iMac? Go to [Take a tour](#).

Get started. Press the power button on the back of your iMac, follow the Setup Assistant prompts, and you're up and running. See [Set up](#) and [Migrate your data](#).

Stay in sync. Access your documents, photos, music, apps, contacts, and calendars across all your devices with iCloud. And use your iMac with your iOS devices to make and receive phone calls and texts, copy and paste across devices, or create an Instant Hotspot. Learn more in [Access your content anywhere with iCloud](#) and [Continuity](#).

Unleash your creativity. Plan events and share info and photos with Notes; organize and listen to music, books, movies, and more with iTunes; create presentations with Keynote; and check out all the apps available on [App Store](#), to express yourself in as many ways as you have ideas.

Dig deeper. Explore your iMac and get your questions answered. Go to [Mac Help](#).

Take a tour

Your iMac is packed with advanced technologies and a beautiful reflection-reducing display in a remarkably thin design.

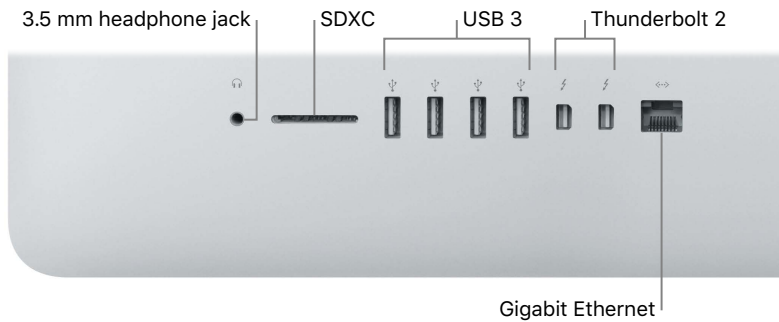

- *3.5 mm headphone jack:* Plug in stereo headphones or a digital 5.1 surround-sound speaker system and experience high-quality sound while watching movies or listening to your favorite music.
- *SDXC card slot:* Transfer photos, videos, and data to and from your iMac, with the latest high-capacity SD cards.
- *USB 3 ports:* Connect an iPad, iPhone, iPod, digital camera, camcorder, external storage, or printer quickly and easily. The iMac USB 3 ports support USB 3 and USB 2 devices.
- *Thunderbolt 2 ports:* Connect high-speed peripherals such as RAID arrays, external displays, and docking stations. Thunderbolt 2 supports adapters (sold separately) for technologies like FireWire or HDMI, for increased connectivity.
- *Gigabit Ethernet port:* Connect a router or modem to get on the Internet, or connect to another computer to transfer files without using Wi-Fi.

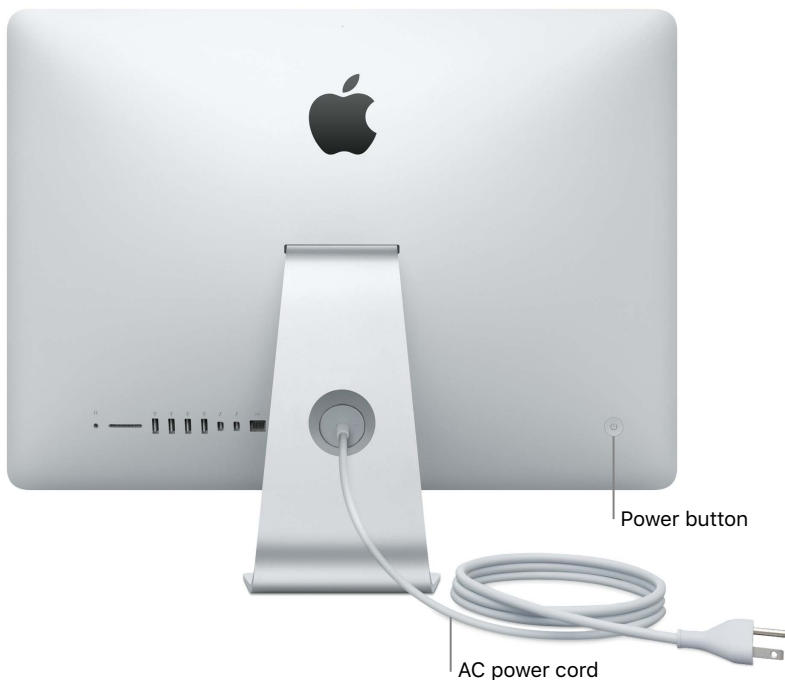

- *AC power cord:* Pass the power cord through the hole in the stand, plug it into the power port on the back of your iMac, then plug the cord into a power outlet.
- *Power button:* Press and hold for three seconds to turn your iMac on or off, or press to put it to sleep.

Connect accessories

Work wirelessly

Using Bluetooth® technology, your iMac can connect wirelessly to devices such as the included Magic Mouse 2 and Magic Keyboard, and to optional devices like the Magic Trackpad 2, peripheral devices, wearable sport accessories, and others. Use the Bluetooth menu  at the top of your screen to connect to, pair, and transfer information between your iMac and the device.

What's included

To use your iMac, you need two accessories included in the box—the Magic Keyboard and the Magic Mouse 2.

Important: To begin using your Magic Keyboard and Magic Mouse 2, simply make sure the on/off switches on both devices are on (green is visible). The devices connect to your iMac automatically.



- **Magic Keyboard:** Your rechargeable Magic Keyboard is already paired with your iMac and is ready to use. If you ever need to charge or pair the keyboard again, connect it to your iMac using the included Lightning to USB cable.

To customize how your keyboard works, use the Keyboard pane of System Preferences. Choose Apple menu > System Preferences, click Keyboard, then click the buttons at the top to see the options available for keyboard, text, shortcuts, and input sources. Read on to learn what the function keys on the Magic Keyboard do.

- **Magic Mouse 2:** Like the Magic Keyboard, your rechargeable Magic Mouse 2 is already paired with your iMac out of the box; you can use it anywhere within range of your computer. If you need to charge the Magic Mouse 2, or if you unpair it and need to pair it again, connect it to your iMac using the included Lightning to USB cable.

To customize your gestures, use the Mouse pane of System Preferences. Choose Apple menu > System Preferences, click Mouse, then click the buttons at the top to see all the scrolling, clicking, swiping, and tapping options.









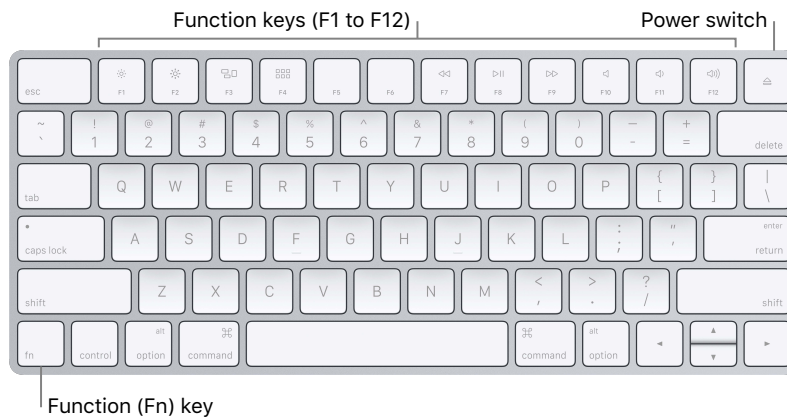

If you configured your iMac with the optional Magic Trackpad 2, it comes paired with your iMac and ready to use. If you purchased a Magic Trackpad 2 separately, connect it to your iMac with the included Lightning to USB cable to pair it automatically. Use this same cable to charge your trackpad as necessary, then unplug it to use in the location that works best for you.

Magic Trackpad 2, adapters, and other accessories are sold separately at apple.com or your local Apple Store. Be sure to review the product information on the Apple website, or on the accessory packaging, to make sure you choose the right product for your iMac.

Keyboard

The function keys on your Magic Keyboard provide shortcuts for common functions, such as increasing the volume or screen brightness.









- **Power switch:** Slide the power switch on the back edge of the keyboard to turn it on (green is visible) or off.
- **Brightness keys (F1, F2):** Press  or  to increase or decrease the brightness of the screen.
- **Mission Control key (F3):** Press  to view what's running on your iMac, including all your spaces and open windows.
- **Launchpad key (F4):** Press  to instantly see all the apps on your iMac. Click an app to open it.
- **Media keys (F7, F8, F9):** Press  to rewind,  to play or pause, or  to fast-forward a song, movie, or slideshow.
- **Mute key (F10):** Press  to mute the sound from the built-in speakers or 3.5 mm Headphone Jack.
- **Volume keys (F11, F12):** Press  or  to increase or decrease the volume of sound from the built-in speakers or 3.5 mm Headphone Jack.
- **Function (Fn) key:** Each function key (on the top row) can also perform other functions—for example, the F12 key can open Dashboard. Hold down the Fn key while you press a function key to trigger the action associated with the key.

Set keyboard preferences. Use the Keyboard pane of System Preferences (choose Apple menu > System Preferences, click Keyboard, then click the buttons at the top to see the available options).

Mouse

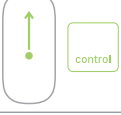
Here are some common gestures you can use with your Magic Mouse 2.

Gesture	Action
	Turn on/off: Slide the power switch on the bottom of the mouse to turn it on (green is visible).
	Click: Press anywhere on the mouse surface to click or double-click.
	Secondary click: Press the left or right side of the mouse to perform a “secondary click.” To turn on Secondary Click, use the Mouse pane of System Preferences.
	360° scroll: Brush one finger along the surface to scroll or pan in any direction.
	Smart zoom: Hold down the Control key and scroll with one finger to enlarge items on your screen.
	Two-finger swipe: Swipe left and right to move through pages, photos, and more.

Customize your gestures. To set preferences and enable gestures, choose Apple menu > System Preferences (or click the System Preferences icon  in the Dock), click Mouse, then click the buttons at the top to see the available options.

Charge the batteries

Your Magic Keyboard and Magic Mouse 2 have built-in rechargeable batteries.

Charge the battery. Connect your Magic Keyboard or Magic Mouse 2 to your iMac with the included Lightning to USB cable. To check the charge level, click  in the menu bar at the top of the screen, then choose your device.

 **Tip:** To charge the battery faster, be sure your input device is turned on when you connect it to your iMac.

For more information about the rechargeable batteries in your Magic Keyboard or Magic Mouse 2, go to www.apple.com/batteries.

Use an external display

The Thunderbolt 2 ports on your iMac support video output. You can use an external display, a projector, or an HDTV with your iMac.

To connect	Do this
Apple Thunderbolt Display	Plug the display's cable directly into the Thunderbolt 2 port ⚡ on your iMac.
DisplayPort or Mini DisplayPort display	Plug the display's Mini DisplayPort cable directly into the Thunderbolt 2 port ⚡ on your iMac.
VGA display or projector	Use a Mini DisplayPort to VGA Adapter to connect the display to the Thunderbolt 2 port ⚡ on your iMac.
DVI display or projector	Use a Mini DisplayPort to DVI Adapter to connect the display to the Thunderbolt 2 port ⚡ on your iMac.
HDMI display or HDTV	Use a Mini DisplayPort to HDMI adapter and an HDMI cable to connect the HDMI display or HDTV to the Thunderbolt 2 port ⚡ on your iMac.

If you have an HDTV connected to an Apple TV, you can also use AirPlay to mirror your iMac screen in up to 1080p HD. See [AirPlay](#) for details.

Adapters and other accessories are sold separately at apple.com or your local Apple Store. Review the documentation or check with the manufacturer to make sure you choose the right adapter.

Get started

2

Set up

The first time you turn on your iMac, Setup Assistant walks you through the simple steps needed to start using your new iMac. If you want to transfer your data from another computer, see [Migrate your data](#) for details.

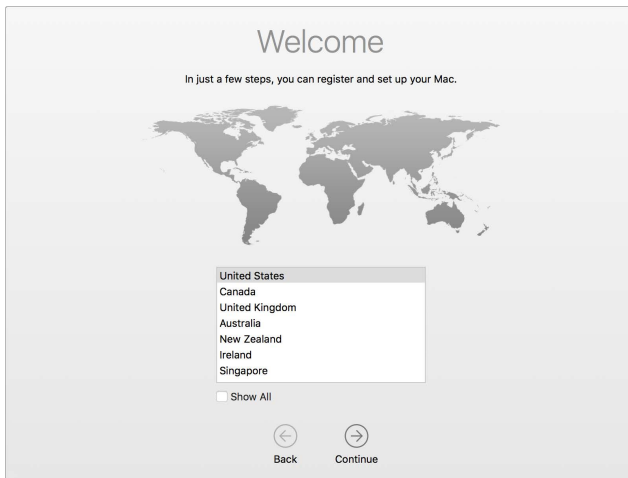



Be sure to connect to Wi-Fi, turn on Bluetooth® wireless technology, get an Apple ID, then sign in to iCloud. You can also activate Siri if you want. You can do these steps quickly and easily with Setup Assistant—but if you want to do them later, here's how:

Connect to Wi-Fi. Click the Wi-Fi status icon  in the menu bar, then choose a Wi-Fi network and enter the password, if necessary.

Turn Wi-Fi on or off. Click the Wi-Fi status icon  in the menu bar, then choose Turn Wi-Fi On or Turn Wi-Fi Off.

Turn Bluetooth on or off. Click the Bluetooth icon  in the menu bar, then choose Turn Bluetooth On or Turn Bluetooth Off.

 **Tip:** If you don't see the Wi-Fi status icon  or Bluetooth icon  in the menu bar, you can add them. For Wi-Fi, choose Apple menu > System Preferences, then click Network. Click Wi-Fi in the list on the left, then select "Show Wi-Fi status in menu bar." For Bluetooth, choose Apple menu > System Preferences, click Bluetooth, then select "Show Bluetooth in menu bar."

Get an Apple ID. Your Apple ID is the account you use for everything you do with Apple—including using the App Store, the iTunes Store, iCloud, iMessage, and more. Your Apple ID consists of an email address and a password. You need only one Apple ID to use any Apple service, on any device—whether it’s your computer, iOS device, or Apple Watch. It’s best to have your own Apple ID and not share it—create separate Apple IDs for each family member.

If you don’t already have an Apple ID, you can create one (it’s free). Go to appleid.apple.com.

Important: If you forget your Apple ID password, you don’t need to create a new Apple ID. Just click the Forgot link in the login window to retrieve your password.

Set up iCloud on your iMac. With iCloud, you can store all of your content—documents, movies, music, photos, and more—in the cloud, and access it anywhere you go.

To set up iCloud, choose Apple menu > System Preferences, then click iCloud. In the window that appears, enter your Apple ID and password. Then select the features you want to use. To find out more, see [Access your content anywhere with iCloud](#).

Important: Be sure to use the same Apple ID for iCloud on all your devices.

For information about setting up and using Siri on your iMac, see [Siri](#).

Find your way around

The desktop

The first thing you see on your iMac is the desktop, where you can quickly open apps, search for anything on your iMac and the web, organize your files, and more.

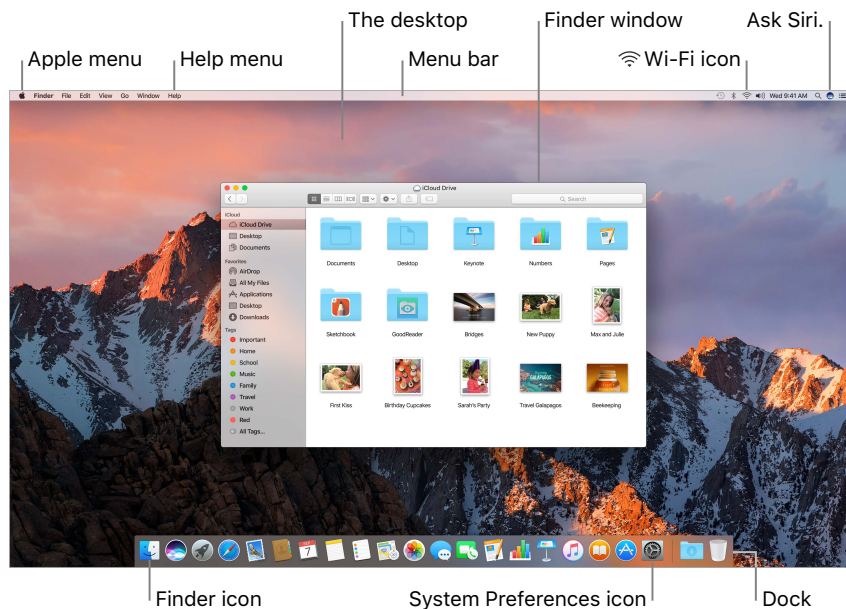

Tip: Can’t find the pointer? To magnify it temporarily, slide the mouse back and forth quickly.

Finder

The Finder  is an app that's always open. Use the Finder to organize and locate your files.

Open a Finder window. Click the Finder icon  in the Dock, at the bottom of the screen.

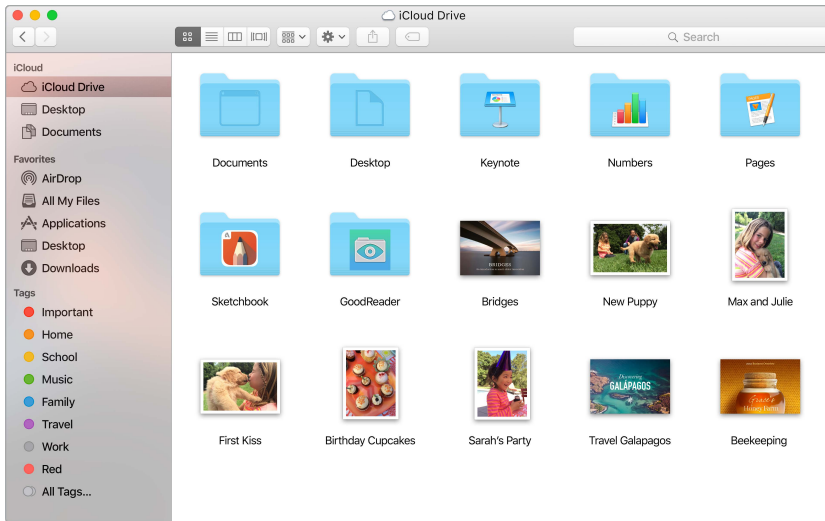

The Dock

The Dock, at the bottom of the screen, is a convenient place to keep the apps and documents you use frequently. You can make the Dock larger or smaller, add or remove items, move it to the left or right side of your screen, or even set it to hide when you're not using it.

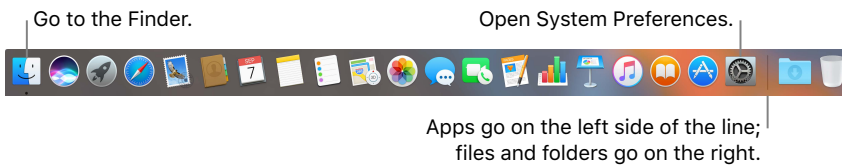

Open an app or file. Click its icon in the Dock.

Add an item to the Dock. Drag the item and drop it where you want it. Place apps to the left of the line in the Dock, and files or folders to the right.

Remove an item from the Dock. Drag it out of the Dock. The item isn't removed from your iMac—just from the Dock.

Change how the Dock looks. Choose Apple menu > System Preferences, then click Dock.



System Preferences

System Preferences is where you personalize your iMac settings. For example, use Energy Saver preferences to change sleep settings. Or use Desktop & Screen Saver preferences to add a desktop background or choose a screen saver.

Customize your iMac. Choose Apple menu > System Preferences, or click the System Preferences icon  in the Dock. Then click the preference you want to set.



Menu bar

Use the menus and icons along the top of the screen to open new windows, connect to a Wi-Fi network, check your Wi-Fi status , change the volume , query Siri, and more. The menu items change, depending on which app you're using.

For more information about using Siri, see [Siri](#).

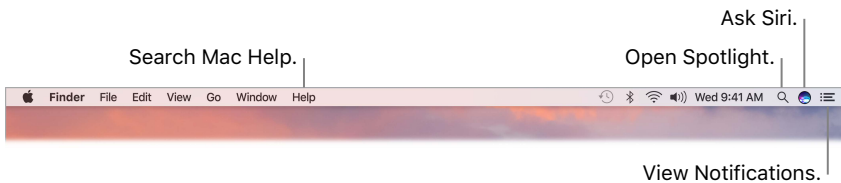

Spotlight

Spotlight  is an easy way to find anything on your iMac, such as documents, contacts, calendar events, and email messages. Spotlight Suggestions offer info from Wikipedia articles, Bing search results, news, sports, weather, stocks, movies, and other sources.

When you search with Spotlight, the preview area on the right provides search results you can interact with—make a call, send an email message, play a song, get directions, even convert currencies. Spotlight can provide answers to math questions or define words, all on your desktop.

Search for anything. Click  at the top right of the screen, then start typing.

 **Tip:** Type Command–Space bar to show or hide the Spotlight search field.

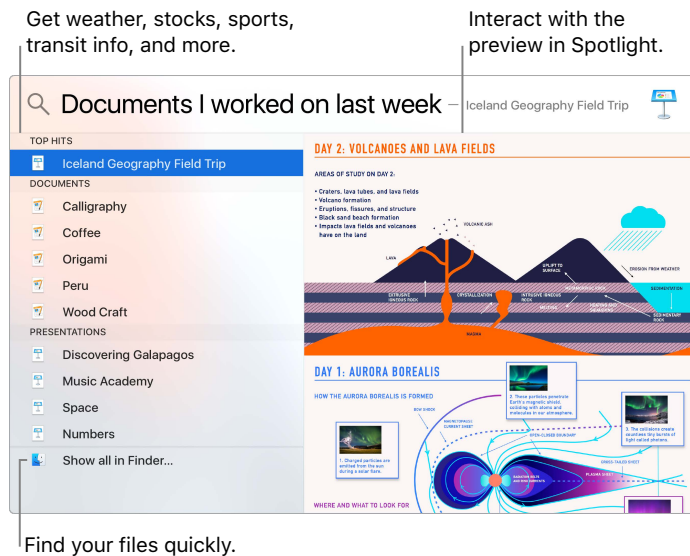

Preview your results. Click a search result and view it in the preview on the right. Sometimes that's all you need to do—click items or links directly in the preview. You can also double-click a result to open it.

Open an app. Type the app name in Spotlight, then press Return.



Turn off Spotlight Suggestions. If you want Spotlight to search only for items on your iMac, you can turn off Spotlight Suggestions in Spotlight preferences. Click the System Preferences icon  in the Dock, click Spotlight, then click to deselect Spotlight Suggestions. Make any other changes you want to the list of categories Spotlight searches.

Note: Not all features of Spotlight Suggestions are available in all languages or regions, and some features may vary by region.

Siri

Now you can talk to Siri on your iMac, just as you do on your iOS devices and Apple Watch, and use your voice for many tasks. For example, you can find files, schedule meetings, change preferences, get answers, send messages, place calls, and add items to your calendar. Siri can give you directions (“How do I get home from here?”), information (“How high is Mount Whitney?”), perform basic tasks (“Create a new list called Groceries”), and much more.

Note: Siri may not be available in all languages or in all areas, and features may vary by area.

Enable Siri. Click the Siri icon  in the menu bar or in the Dock, then click Enable when prompted. Or click the System Preferences icon  in the Dock, click Siri, then select Enable Siri. You can also set other options, such as Language.



Note: To use Siri, your iMac must be connected to the Internet.

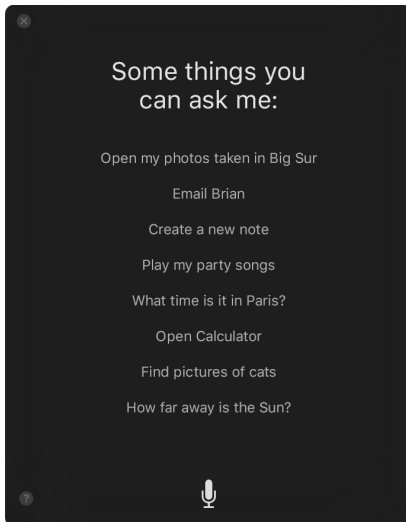

When you first open Siri on your Mac, you'll see a list of suggestions about how to use Siri to save time and typing.



Speak to Siri. Click Siri  in the menu bar or the Dock and start speaking. Or press and hold the Command key and the Space bar and speak to Siri.

Find and open files. Ask Siri to find files and open them right from the Siri window. You can ask by file name, by tags, or by description. For example, “Search for files Ursula sent last week,” or “Open the spreadsheet I created last night.”

Drag and drop. Drag and drop images and locations from the Siri window into an email, text message, or document. You can also copy and paste text.

Pin a result. Save Siri results from Sports, Reminders, Clock, Stocks, Notes, Finder, and general knowledge (Wikipedia, for example) to the Today view in Notifications. Click the plus sign  in the top right of a Siri result to pin it to the Today View. To see it later, click the Notification Center icon , then click Today. If you're checking a sports score, for example, results stay up to date.

Adjust the volume. Use the volume buttons on your keyboard to increase or decrease the volume while you're interacting with Siri.

Change the voice. Click the System Preferences icon  in the Dock, click Siri, then choose an option from the Siri Voice menu.

You'll find suggestions for things you can ask Siri throughout this guide—they look like this:

 **Ask Siri.** Say something like:

- “Open the Keynote presentation I was working on last night.”
- “What time is it in Paris?”
- “What kinds of things can I ask you?”

Notification Center

Use Notification Center to view details about your day (calendar, stocks, weather, and more) and catch up on notifications you might have missed (email, reminders, app notifications, and more).

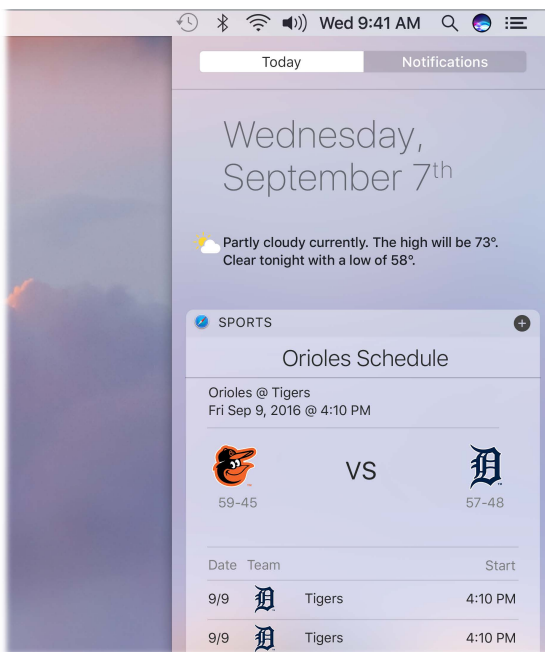

Open Notification Center. Click the Notification Center icon  at the top right of the screen. Tap Today to see what's coming up or Notifications to review what's come in.

Help

Help for your iMac and apps is always available.

Get help. Click the Finder icon , then click the Help menu and choose Mac Help. Or type in the search field and choose a suggestion.

To learn more, see [Mac Help](#).

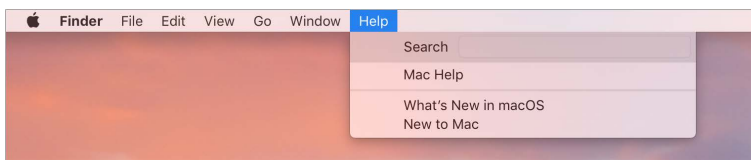

Unlock your iMac with Apple Watch

Use your authenticated Apple Watch to automatically unlock and wake your sleeping iMac when you're within about three meters of your computer. Just wake your Mac and start using it—no need to enter a password. Auto Unlock uses strong encryption to provide secure communication between your Apple Watch and iMac.

Note: Auto Unlock is a feature for Macs (mid-2013 or later) running macOS Sierra, and Apple Watch running watchOS 3.



Set up two-factor authentication for your Apple ID. Auto Unlock works when your Apple ID has two-factor authentication turned on. Go to Apple menu > System Preferences > iCloud > Account Details, click Security, then select Set Up Two-Factor Authentication. For more information, see the Apple Support article support.apple.com/HT204915.

Make sure "Disable automatic login" is also selected. (You won't see this option if you're using FileVault, but you can still use the Auto Unlock feature.)

Set up Auto Unlock. Sign in to iCloud with the same Apple ID on all your devices, then click the System Preferences icon  in the Dock, or choose Apple menu > System Preferences. Click Security & Privacy, then select "Allow your Apple Watch to unlock your Mac."

Note: Auto Unlock works only when your Apple Watch is authenticated. You authenticate your Apple Watch each time you put it on, so no extra steps are required after you enter your passcode.

Skip the sign-in. Walk up to your sleeping iMac wearing your authenticated Apple Watch on your wrist, and press a key to wake your Mac. Apple Watch unlocks your Mac so you can get right to work.

Quickly open apps

Your iMac comes with apps for all the things you love to do—browse the web, check email, share photos, enjoy movies, and more.

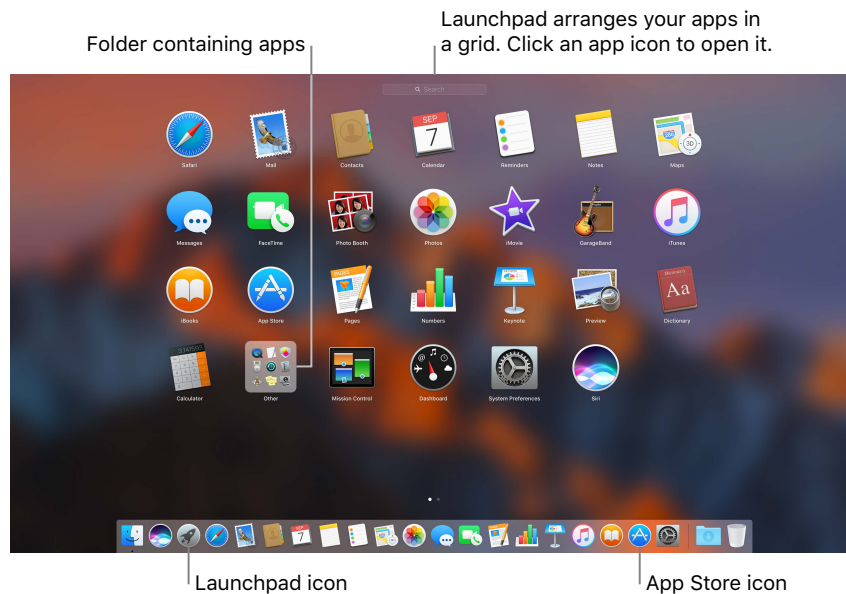

Open an app. Click an app icon in the Dock, or click the Launchpad icon  in the Dock, then click the app you want. You can also search for an app using Spotlight, then open the app directly from your Spotlight search results.

 **Ask Siri.** Say something like: “Open Calculator.”

Organize apps in Launchpad. Launchpad organizes your apps in a grid. Drag an app to a new location to rearrange apps. Drag an app onto another app to create a folder. Drag more apps to the new folder to add them. To remove an app from a folder, drag it out.

Get more apps. Click the App Store icon  in the Dock and search for apps you want. Apps you download from the App Store appear automatically in Launchpad. To quickly get updates for apps and macOS, click Updates in the App Store.

Multitask on your desktop

The Tabs feature is available in most apps that support multiple windows, such as Pages, Numbers, Maps, and more. And while you're browsing multiple tabs, you can watch a video using Picture in Picture.

Note: Picture in Picture is not available in all regions.

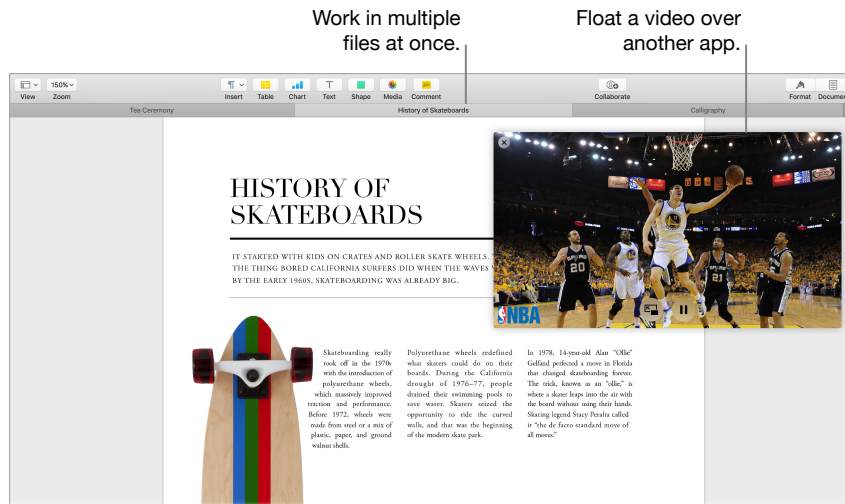

Browse content with tabs. Open multiple tabs in an app to compare content—for example, Numbers spreadsheets or Pages documents. Or copy and paste content from one tab to another. Tabs also work with third-party apps.

To set tab preferences, choose Apple menu > System Preferences, then click Dock. Choose an option for “Prefer tabs when opening documents.”

Watch while you work. Click the Picture in Picture button  in a Safari or iTunes video. You can drag it to any corner of your desktop. Your video stays put while you switch between apps and spaces.

Access your content anywhere with iCloud

iCloud is the easiest way to make sure all your important content is everywhere you are. iCloud stores your documents, photos, music, apps, contacts, and calendars, so you can access them any time you're connected to Wi-Fi.

An iCloud account is free, and it comes with 5 GB of free storage space. Purchases you make from the iTunes Store, App Store, or iBooks Store don't count toward your available space.

iCloud also keeps everything up to date on your devices. So if you have an iPhone, iPad, or iPod touch, just sign in to iCloud using the same account and you'll have everything you need.



Here are some of the things you can do with iCloud.

Automatically store your desktop and Documents folder in iCloud Drive. Save files in your Documents folder or on your desktop, and they're automatically available on iCloud Drive and accessible wherever you are. Working with iCloud Drive, you have access to files on your iPhone or iPad in the iCloud Drive app, on the web at [iCloud.com](https://www.icloud.com), or on a Windows PC in the iCloud app. When you change your file in iCloud Drive, you'll see your edits wherever you view the file.

To get started, click the System Preferences icon  in the Dock, click iCloud, select iCloud Drive, click Options, then select "Desktop & Documents Folders."

Share purchases with Family Sharing. Up to six members of your family can share their purchases from the iTunes Store, App Store, and iBooks Store—even if they use different iCloud accounts. Pay for family purchases with one credit card, and approve kids' spending right from your iMac or iOS device. Plus, share photos, a family calendar, reminders, and locations. To set up Family Sharing if you didn't when you set up your Mac, click the System Preferences icon  in the Dock, click iCloud, then click Set Up Family.

Share photos using iCloud Photo Library and iCloud Photo Sharing. Store your photo library in iCloud and see your photos and videos on all your devices. Share photos and videos with only the people you choose, and let them add their own photos, videos, and comments. To get started, click the System Preferences icon  in the Dock, click iCloud, select Photos, then click Options.

Enjoy your purchases anywhere. When you're signed in to iCloud, purchases you've made from the iTunes Store, App Store, and iBooks Store are available at any time, no matter which computer or device you used to purchase them. So all your music, movies, books, and more are available wherever you go.

Locate your iMac with Find My Mac. If your iMac is stolen, you can easily locate it on a map, lock its screen, or even erase its data remotely if you have Find My Mac turned on. To turn on Find My Mac, click the System Preferences icon  in the Dock, click iCloud, then click Find My Mac.

For more information about what you can do with iCloud, go to Mac Help (see [Mac Help](#)) and search for "iCloud," or go to www.apple.com/icloud.

Use your iMac and iOS devices together

Continuity

With Continuity, you can seamlessly move among your iOS devices and your iMac. Just sign in to your iCloud account on your iMac and your iOS devices, and whenever they're near each other, they work together in great ways. Continuity features described in this section include Handoff, Universal Clipboard, iPhone cellular calls, SMS messaging, and Instant Hotspot.

Other Continuity features include Auto Unlock (see [Unlock your iMac with Apple Watch](#)), Apple Pay (see [Apple Pay](#)), and AirDrop (see [AirDrop](#)). For a list of system requirements for devices that support Continuity, see the Apple Support article support.apple.com/HT204689.

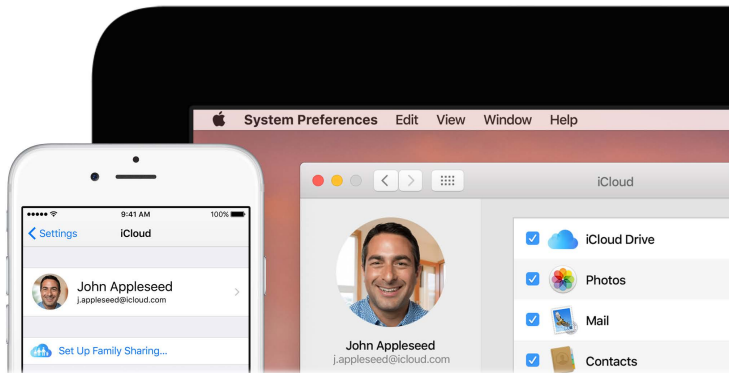

Handoff

With Handoff, you can pick up on one device where you left off on another. Work on a presentation on your iMac, then continue on your iPad. Or start an email message on your iPhone, then finish it on your iMac. View a message on your Apple Watch, and respond to it on your iMac. You don't have to worry about transferring files. When your iMac and devices are near each other, an icon appears in the Dock whenever an activity is being handed off; to continue, just click the icon.

Click to continue what you were doing on your iPhone.



Turn on Handoff on your iMac. Click the System Preferences icon  in the Dock, click General, then select “Allow Handoff between this Mac and your iCloud devices.”

Turn on Handoff on your iOS device. Go to Settings > General > Handoff & Suggested Apps, then tap to turn on Handoff. If you don't see the option, your iOS device doesn't support Handoff.

Turn on Handoff on your Apple Watch. In the Apple Watch app on iPhone, go to Settings > General, then tap to turn on Enable Handoff.

Note: To use Handoff, you need an iPhone, iPad, or iPod touch with the Lightning connector and iOS 8 (or later) installed. Make sure your iMac and iOS device have Wi-Fi and Bluetooth turned on and are signed in to the same iCloud account.

Handoff works with Safari, Mail, Calendar, Contacts, Maps, Messages, Notes, Reminders, Keynote, Numbers, and Pages.

Universal Clipboard

Copy content from one device, and paste it into another nearby device within a short period of time. The contents of your clipboard are sent over Wi-Fi and made available to all Mac and iOS devices logged in with the same Apple ID that have Handoff, Wi-Fi, and Bluetooth turned on. See [Handoff](#) for more information.

Note: To use Universal Clipboard, you need an iPhone, iPad, or iPod touch with the Lightning connector and iOS 10 (or later) installed.

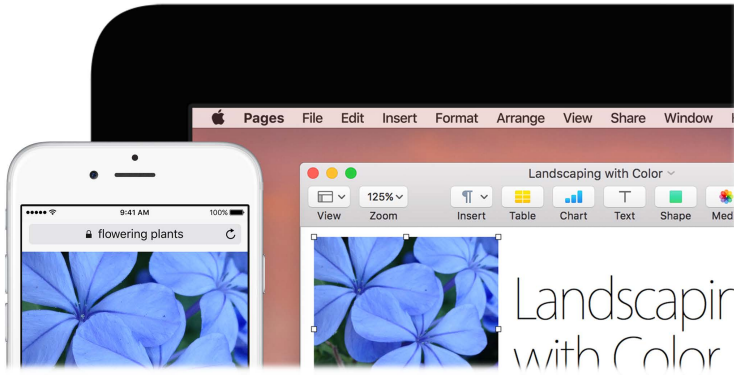

Use across apps. You can copy and paste images, text, photos, and video between any apps that support copy and paste on your Mac, iPhone, iPad, and iPod touch.

Phone calls

You can take calls—and make them—right from your iMac.

Note: A Wi-Fi connection is required in order to make or receive phone calls on your iMac.

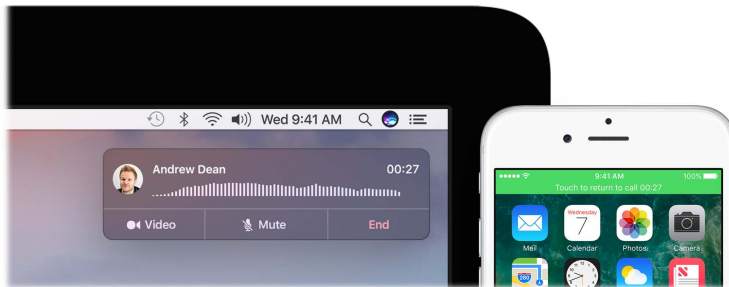

Take a call. When someone calls your iPhone, click the notification that appears on your iMac screen. Your iMac becomes a speakerphone.

Make a call. Click a phone number in a Spotlight search or in an app such as FaceTime, Contacts, Safari, or Calendar. A nearby device (iPhone, iPad) with a cellular connection is required in order to make phone calls.

Text messages

Send and receive SMS and MMS text messages right from your iMac. When friends and family text you, you can respond with whichever device is closest. All messages appear on your iMac, iPhone, iPad, iPod touch, and Apple Watch.

Note: To set up this feature, go to Messages > Preferences and click Accounts.

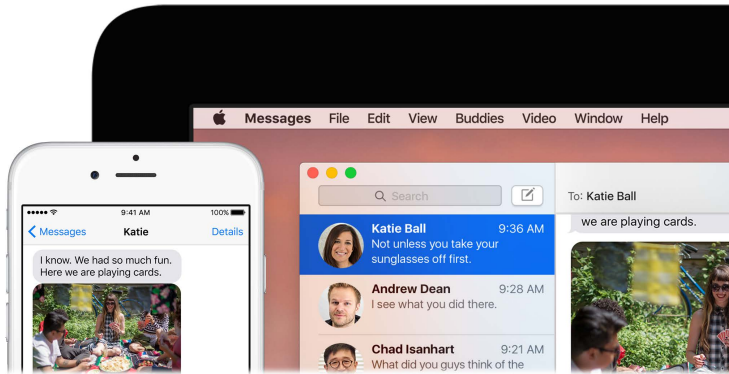

Instant Hotspot

Lost your Wi-Fi connection? Use the Personal Hotspot on your iPhone or iPad to connect your iMac to the Internet.

Note: Personal Hotspot requires an iPhone or a cellular model iPad, with iOS 8 or later.

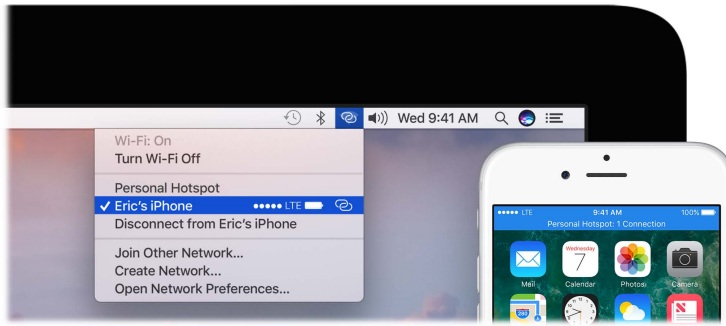

Connect to your device's Personal Hotspot. Click the Wi-Fi status icon  in the menu bar, then choose your iPhone or iPad from the list of devices that appears. (You don't need to do anything on your device—iMac connects automatically.)

Check the status of your connection. Look in the Wi-Fi status menu to see the strength of the cellular signal.

When you're not using the hotspot, your iMac disconnects to save battery life.

To learn more about using Instant Hotspot, messages, phone calls, Universal Clipboard, and Handoff with your iMac, open Mac Help (see [Mac Help](#)). See the Apple Support article support.apple.com/HT204681 or go to www.apple.com/osx/continuity.

Apple Pay

The convenience and security of Apple Pay is now available on your Mac. With Apple Pay, your credit or debit card information is never stored or shared by Apple with the merchant. When you shop online using Safari, look for a “Buy with Apple Pay” button. Confirm payment using your iPhone or Apple Watch.

Note: For information about Apple Pay availability and current card issuers, see the Apple Support articles support.apple.com/HT204916 and www.apple.com/apple-pay/where-to-use-apple-pay.

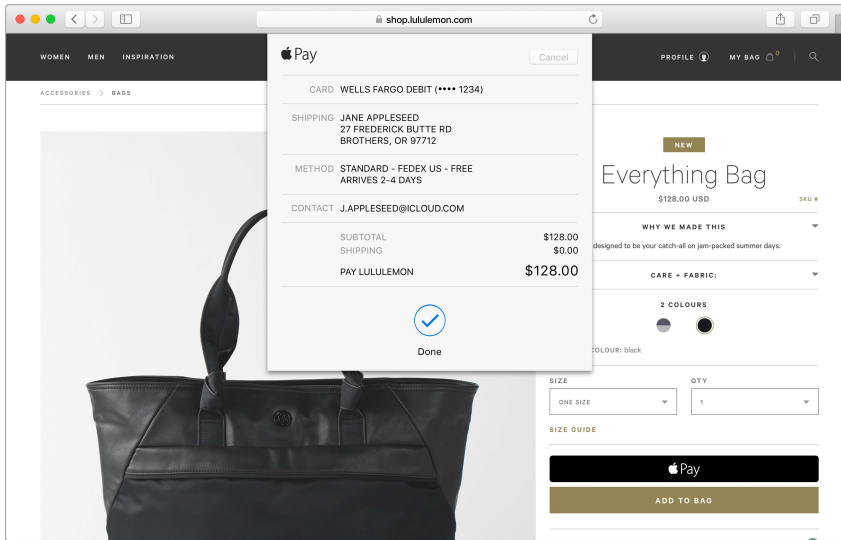

Set up Apple Pay. Apple Pay uses the credit or debit cards you’ve already set up on your iPhone or Apple Watch, so no extra setup is required. You must be signed in to an iPhone or Apple Watch that has Apple Pay set up with the same Apple ID you’re using on your iMac. The default payment card, shipping, and contact information that is set on your iPhone or Apple Watch will be used for purchases on your Mac.

Make a purchase. Click the Apple Pay button on the website, then to confirm the payment, use Touch ID or the passcode on your iPhone, or double-click the side button on your unlocked Apple Watch.

For more information about using Apple Pay, see the Apple Support article support.apple.com/HT201239.

AirDrop

AirDrop makes it easy to share files with nearby Mac computers and iOS devices. The devices don't need to share the same Apple ID.

Note: AirDrop for iOS requires devices that have the Lightning connector and iOS 7 or later. Not all older Macs support AirDrop (for a list of supported Macs, see the Apple Support article support.apple.com/HT203106).

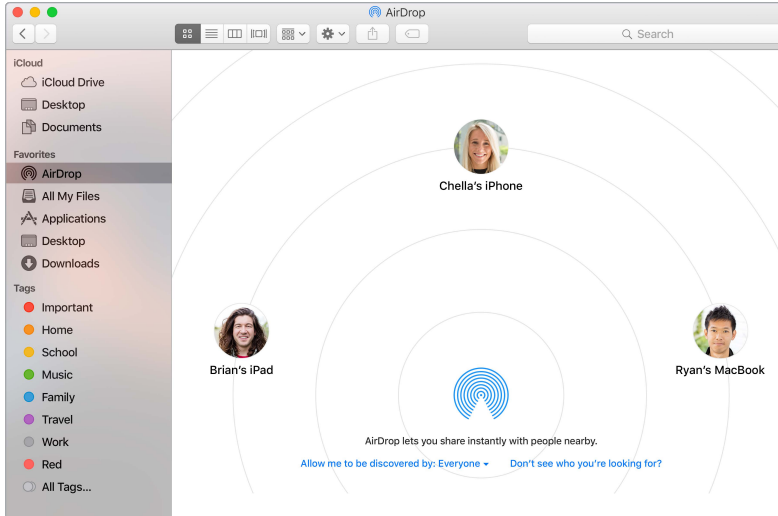

Send a file from the Finder. Click the Finder icon  in the Dock, then click AirDrop in the sidebar on the left. When the person you want to send a file to appears in the window, drag the file to him or her.

Send a file from an app. While using an app like Pages or Preview, click the Share button  and choose AirDrop.

Control who can send items to you using AirDrop. Click the Finder icon  in the Dock, click AirDrop in the sidebar, then click "Allow me to be discovered by" and choose an option.

When you send a file to someone, the recipient can choose whether or not to accept the file. When someone sends you a file, you can find it in the Downloads folder on your iMac.

 **Tip:** If you don't see the recipient in the AirDrop window, make sure both devices have AirDrop and Bluetooth turned on and are within 30 feet (9 meters) of each other.

To learn more about AirDrop, go to Mac Help (see [Mac Help](#)).

AirPrint

You can use AirPrint to print wirelessly to:

- An AirPrint-enabled printer on your Wi-Fi network
- A network printer or printer shared by another Mac on your Wi-Fi network
- A printer connected to the USB port of an AirPort base station

Print to an AirPrint printer. When you print from an app, click the Printers pop-up menu in the Print dialog, choose Nearby Printers, then choose an AirPrint printer.

Can't find the printer you're looking for? Make sure it's connected to the same Wi-Fi network as your iMac. If it is connected and you still don't see it, try adding it: Click the System Preferences icon  in the Dock, click Printers & Scanners, then click Add +. (You may have to temporarily connect the printer to your iMac using a USB cable.)

For a list of AirPrint-enabled printers and other supported printers, see the Apple Support articles support.apple.com/kb/HT201311 and support.apple.com/kb/HT201465.

AirPlay



Show whatever's on your iMac on the big screen using AirPlay Mirroring. Connect your HDTV to Apple TV, and make sure the Apple TV is on the same Wi-Fi network as your iMac to mirror the iMac screen on your TV screen or use the HDTV as a second display. You can also play some web videos directly on your HDTV without showing what's on your desktop—handy when you want to play a movie but keep your work private.



Mirror your desktop using AirPlay Mirroring. Click the AirPlay icon  in the menu bar, then choose your Apple TV. When an AirPlay display is active, the icon turns blue.

In some cases, you can use an AirPlay display even if you're not on the same Wi-Fi network as Apple TV (called *peer-to-peer AirPlay*). To use peer-to-peer AirPlay, you need an Apple TV (3rd generation rev A, model A1469 or later) with Apple TV software 7.0 or later.

Play web videos without showing your desktop. When you find a web video with an AirPlay icon , click the icon, then select your Apple TV.

 **Tip:** If the image doesn't fit your HDTV screen when you mirror the screen, adjust the desktop size for the best picture. Click the AirPlay icon , then choose an option under "Match Desktop Size To."

Apple TV is sold separately at apple.com or your local Apple Store.

To learn more about AirPlay, go to Mac Help (see [Mac Help](#)). To learn more about using a second display with your iMac, see [Use an external display](#).

Migrate your data

It's easy to move your files and settings from another Mac or PC to your iMac. To transfer the data when you first set up your iMac, use Setup Assistant. To transfer data later, you can use Migration Assistant. If both computers are connected to the same Wi-Fi network, you can transfer the data wirelessly.

Tip: For best results, make sure your iMac is running the latest version of macOS. To check for software updates, click the App Store icon  in the Dock, then click Updates in the App Store toolbar.

If you used Time Machine to back up your files from another Mac to a storage device (such as an AirPort Time Capsule or an external disk), you can copy the files from the device to your iMac.





Use Migration Assistant. Open a Finder window, go to Applications > Utilities, then double-click Migration Assistant. Follow the onscreen instructions. For more information, see the Apple Support article support.apple.com/en-us/HT204350.

You can transfer data from a Thunderbolt-equipped Mac to your new iMac using a Thunderbolt cable. Put the Mac you want to migrate data from in Target Disk Mode by restarting it while holding down the T key. Then connect the two computers using a Thunderbolt cable, and open Migration Assistant on your iMac. Select “From a Mac, Time Machine backup, or startup disk” when asked how you want to transfer your information, click Continue, then select the disk you want to transfer information from.

Use Target Disk Mode. You can transfer data from a Thunderbolt-equipped Mac to your new iMac using a Thunderbolt cable. Put the Mac you want to migrate data from in Target Disk Mode by restarting it while holding down the T key. Then connect the two computers using a Thunderbolt cable, and open Migration Assistant on your iMac. Select “From a Mac, Time Machine backup, or startup disk” when asked how you want to transfer your information, click Continue, then select the disk you want to transfer information from.

Tip: For fastest migration, connect your old computer to iMac with a cable (for example, a Thunderbolt cable). If you migrate wirelessly, you'll get best results if you keep both computers near each other throughout the migration process.

Copy files from a storage device. Connect the device to the USB 3 port  or Thunderbolt 2 port  on your iMac, then manually drag files to your iMac.

Save space on your iMac

macOS Sierra frees up space on your iMac and helps you save space as you work. You can set options to free up even more space on your iMac.

Optimize storage. Set options in the Recommendations pane. Go to Apple menu > About This Mac, click Storage, then click Details. When your Mac is low on storage, you'll see an alert that will open the Recommendations pane.

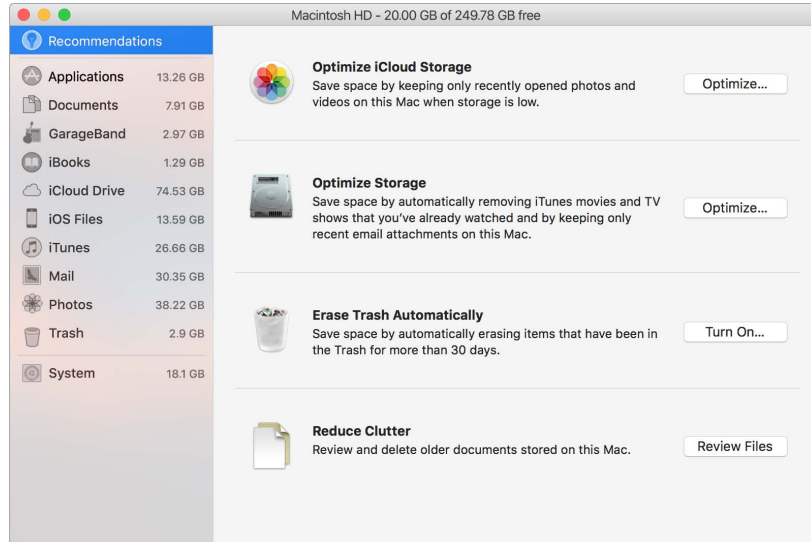

Set options to:

- *Optimize iCloud Storage:*
 - Store files in iCloud, where they stay secure and available. You can turn on iCloud Drive to store files on your desktop and in your Documents folder in iCloud.
 - Turn on iCloud Photo Library to store items from the Photos app in iCloud.For more information, see [Access your content anywhere with iCloud](#).
- *Optimize Storage:* Remove iTunes movies and TV shows you've watched, and keep only recent email attachments.
- *Erase Trash Automatically:* Automatically erase items that have been in the Trash for more than 30 days.
- *Reduce Clutter:* Review documents and delete older ones stored on your iMac.

macOS Sierra also prevents you from downloading the same file twice from Safari, alerts you to remove installer software when you finish installing a new app, clears logs and caches that are safe to remove when you're low on storage, and more, to help you save space as you work.

Back up and restore

To keep your files safe, it's important to back up your iMac regularly. The easiest way to back up is to use Time Machine—which is built into your iMac—with a wireless AirPort Time Capsule (sold separately), or an external storage device connected to your iMac.

Files stored in iCloud Drive and photos in iCloud Photo Library are automatically backed up to the cloud and don't need to be part of your Time Machine or other backup.

Set up Time Machine. Make sure your iMac is on the same Wi-Fi network as your AirPort Time Capsule, or connect your storage device to your iMac. Then click the System Preferences icon  in the Dock, click Time Machine, then click On. Select the drive you want to use for backup, and you're all set.



Time Machine:

- Automatically backs up your entire iMac, including system files, apps, accounts, preferences, music, photos, movies, and documents.
- Remembers how your computer looked on any given day, so you can revisit your iMac as it appeared in the past or retrieve an older version of a document.
- Lets you restore your entire system from a Time Machine backup. So if anything happens to your iMac, your files and settings are safe and sound.

To learn more about backing up and restoring your iMac, go to Mac Help (see [Mac Help](#)) and search for “Time Machine,” “external storage device,” “backup,” or “restore.” To learn more about AirPort Time Capsule, go to www.apple.com/airport-time-capsule.

AirPort Time Capsule is sold separately at apple.com or your local Apple Store.

Included apps

Your iMac comes with a collection of great apps for things you do every day, like surfing the web, sending mail and messages, and arranging your calendar. It also comes with apps like Photos, iMovie, GarageBand, Pages, Numbers, and Keynote—so you can be creative and productive right from the start. The apps that come with your iMac are described in the following sections.



Find even more apps. Click the App Store icon  in the Dock to find apps for everything you want to do. See [App Store](#) to learn more.

Get help for any app. Click the Help menu (in the menu bar at the top of the screen) when you're using an app.





Safari is the fastest, safest, and most energy efficient way to surf the web on your Mac.

Start searching. Click the Smart Search field at the top of the window to see websites you visit most frequently. Or start typing a word or website address—Safari shows you matching websites, as well as Safari Suggestions for news, Wikipedia articles, iTunes music, weather forecasts, sports scores and player stats, stock prices, help from Apple, and nearby points of interest.

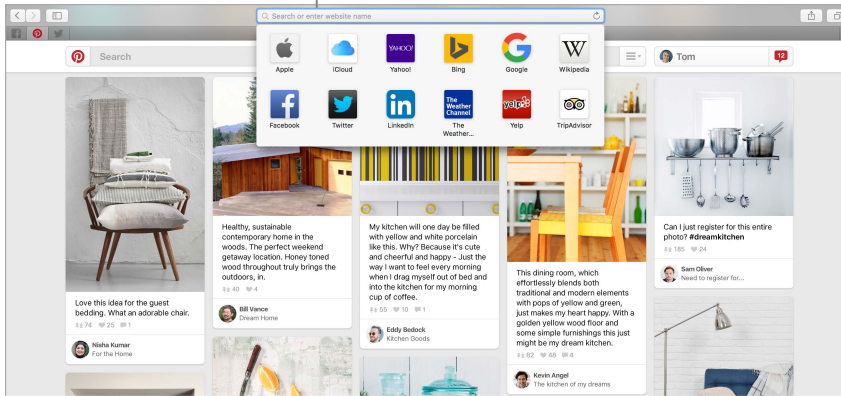
Type what you're looking for or click a favorite.



Spread the word. It's easy to share a webpage on social media, save it to your bookmarks or reading list, or add it to Notes or Reminders. Just click the Share button  at the top of the window and choose an option.

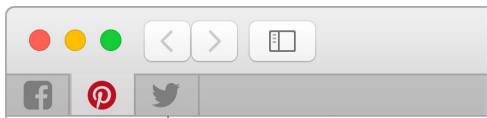

View multiple pages in one window. Click  at the far right of the tab bar to open a new tab, then enter an address. To keep a website handy, drag its tab left to "pin" it, and it stays put in the tab bar.



Drag a tab to the left to pin it in the tab bar.

See what's open on all your devices. You can see open webpages on all your devices that are signed in to the same iCloud account. Just click the Show All Tabs button  at the top of the window and scroll down if necessary.

Shop with Apple Pay. When you're shopping online on a supported website, click the Apple Pay button to make a purchase. To complete the transaction, use Touch ID or the passcode on your iPhone, or double-click the side button on your unlocked Apple Watch.

 **Tip:** If the article you're reading includes animations or flashy ads, you can use Reader view to strip out the distractions and focus on the text. Click the Show Reader View button  in the search field (if it's available).



Mail

Mail lets you manage all your email accounts from a single app. It works with most popular email services, such as iCloud, Gmail, Yahoo Mail, and AOL Mail.

One-stop email. Tired of signing in to multiple websites to check your email accounts? Set up Mail with all your accounts so you can see all your messages in one place. Choose Mail > Add Account.

Ask Siri. Say something like: "Any new mail from Laura today?"

Add events and contacts right from Mail. When Mail detects a new email address or event in a message, just click Add to add it to Contacts or Calendar.

Add names or events to your contacts or calendar with a single click.

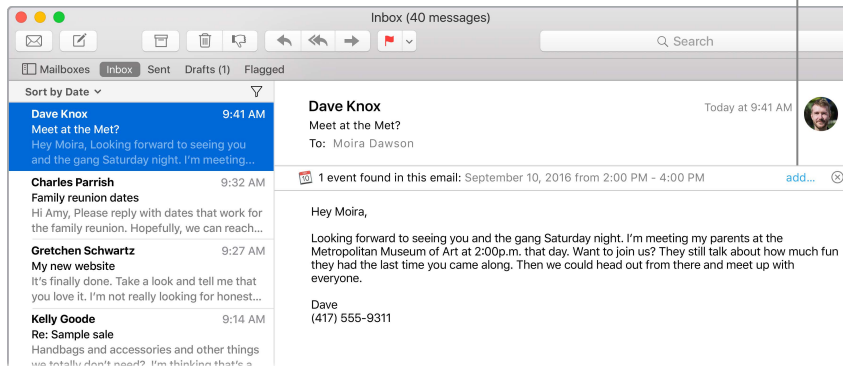

Never miss an email. Check the Mail icon in the Dock to see a count of unread emails. When you get a new email, a notification also appears at the top-right of the screen so you can quickly preview incoming messages. (Don't want notifications? You can turn them off: Click the System Preferences icon in the Dock, then click Notifications.)

You have unread messages.



Tip: To quickly delete an email in your inbox, swipe left on the message with one finger on your Magic Mouse 2, then click Trash. Or swipe right to mark the email as Unread.

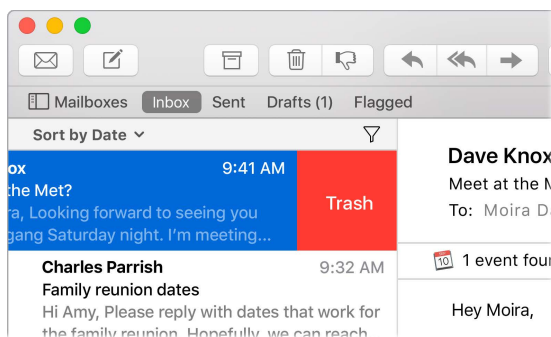



Notes

Notes are more than just text. Add a checklist, and check off items as you complete them. Or add photos, videos, and content from other apps, such as web links from Safari or a location from Maps.

 **Ask Siri.** Say something like: “Create a new note.”

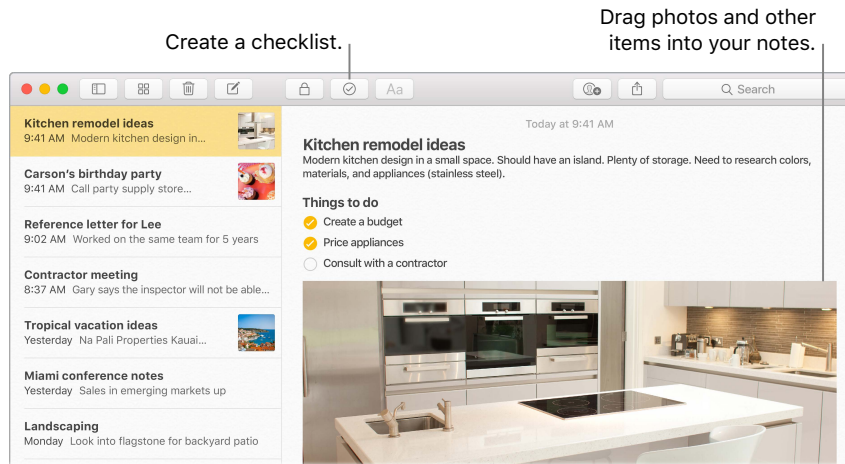
Check off tasks. Click the Checklist button  to add an interactive checklist to a note—perfect for completing a to-do list or working through a recipe.



 **Tip:** When you're signed in to iCloud, your notes are kept up to date on all your devices—so you can create a to-do list on your Mac, then check items off on your iPhone while you're on the go.

Add photos, videos, and more. Click the Photos button  to add items from your Photos library to a note. Or drag a photo, video, PDF, or other document from the desktop.

Sort notes. You can sort your notes by Date Created, Date Edited, or Title. Select “All iCloud,” “Notes,” or a folder, then choose View > Sort Notes By and select a sort option.

Share a note. You can invite people to view and edit your notes by sharing them. Click the People button  and select a method for sending the link.

Lock a note. You can lock a note with a password to make sure that only those who know the password can see the note. Choose Notes > Set Password to assign a password to use with all locked notes. Then select the note you want to lock, and choose File > Lock Note.

Messages

It's easy to stay in touch with Messages. Connect with one or more people through text, audio, or video. And if you want to share files, you can do that, too.

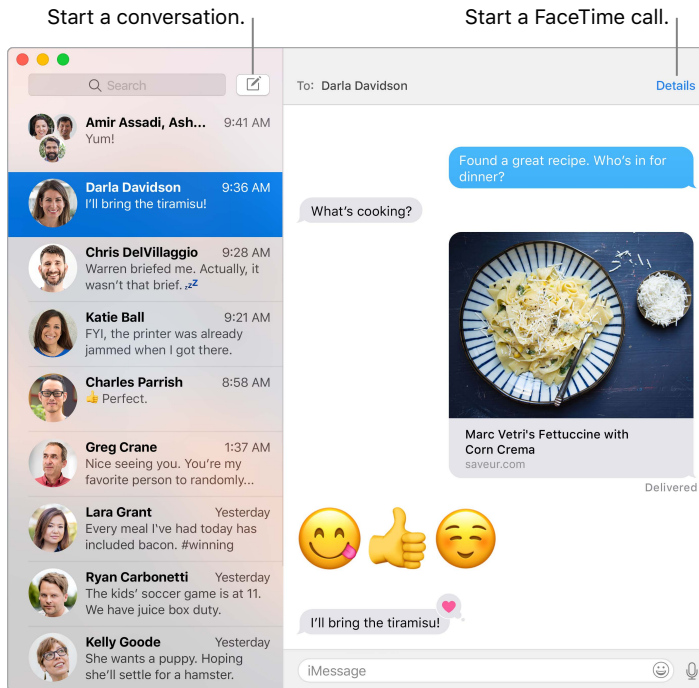

Sign in and send. Sign in with your Apple ID to exchange unlimited iMessage texts—including text, photos, live photos, video, and more—with anyone with a Mac, iPhone, iPad, iPod touch, or Apple Watch.

Tip: You can also send and receive SMS and MMS messages on your Mac, so you can text friends with an iPhone from your Mac, if your iPhone (with iOS 8.1 or later) is signed in to Messages with the same Apple ID. On your iPhone, go to Settings > Messages, tap Message Forwarding, then tap the name of your Mac to turn on Text Message Forwarding. On your Mac, you'll see an activation code. Enter this on your iPhone, then tap Allow.

Ask Siri. Say something like: "Tell Mom that I'll be late."

Make messages fun. Liven up discussions by responding to messages with large emoji or Tapbacks. To add a Tapback, Control-click a message bubble, then choose Tapback. And look out for stickers, Digital Touch, invisible ink, and handwritten messages that your friends send you from their iOS device or Apple Watch.

When a text isn't enough. If your friend also has FaceTime, you can start a FaceTime video or audio chat right from a conversation in Messages. Just click Details in the message window, then click the Audio or Video button.

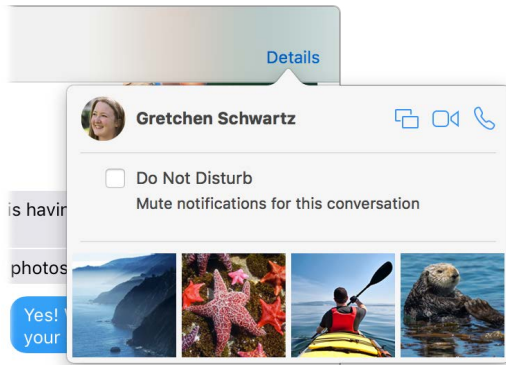

Share your screen. You can share your screen with a friend—and vice versa—and even open folders, create documents, and copy files by dragging them to the desktop on the shared screen. Click Details, then click the Screen Share button.

Calendar

Never miss an appointment with Calendar. Keep track of your busy schedule by creating multiple calendars, and manage them all in one place.

Create events. Click + to add a new event, or double-click anywhere in a day. To invite someone, double-click the event, click the Add Invitees section, then type an email address. Calendar lets you know when your invitees reply.

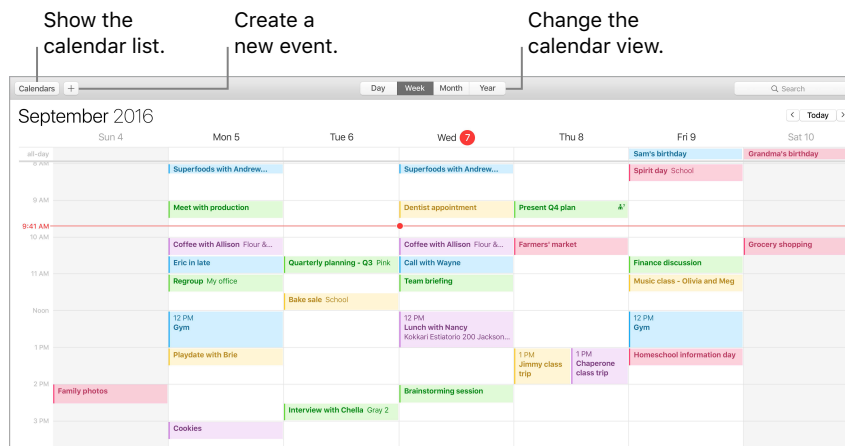

See all your calendars—or just a few. Click the Calendars button to see a list of all your calendars; click the ones you want to see in the window.

 **Ask Siri.** Say something like: “Set up a meeting with Mark at nine in the morning.”

A calendar for every part of your life. Create separate calendars—for example, for home, work, and school—each with its own color. Choose File > New Calendar to create a calendar, then Control-click the calendars to choose a new color.

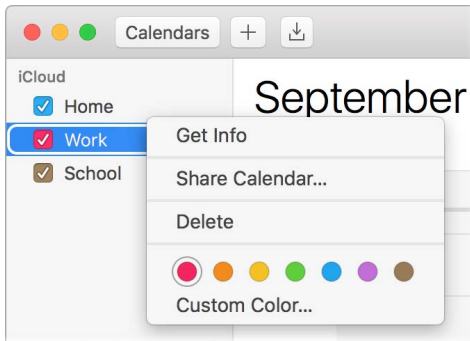

Share across your devices and with others. When you're signed in to iCloud, your calendars are kept up to date on all your Macs and iOS devices. You can also share calendars with other iCloud users.

Tip: If you add a location to an event, Calendar shows you a map, estimated travel time and time to leave, and even the weather forecast.

Photos

Use Photos to organize, edit, and share your photos, and keep your entire photo library up to date on all your devices with iCloud Photo Library. You can also create slideshows and beautiful photo gifts.

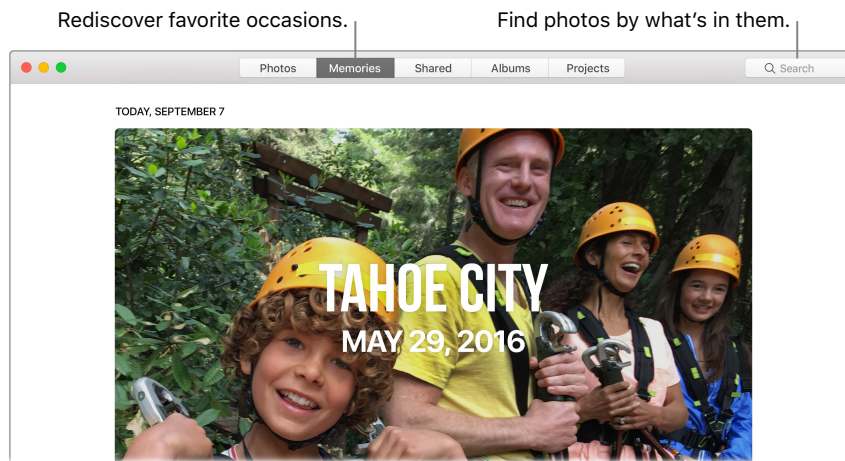

Relive meaningful moments. Click Memories in the sidebar to see favorite and forgotten occasions from your photo library. Memories automatically creates photo collections from events like a wedding or family vacation.

Find the perfect shot. Search your photos based on what's in them. Photos identifies objects, scenes, and people, so you don't have to use keywords to tag each photo.

Ask Siri. Say something like: "Show me pictures of Sally at the beach."

See who's in your photo albums. The People feature automatically organizes your photo library by people in your photos. The People album is arranged by how often each person appears in your library. Make someone a favorite by dragging their photo to the top and they'll always appear at the top of the album.

See where you've been. Click the Places album to view your photo collection on a world map. You can zoom in to see exactly where you took each shot.

Tip: You can add location info to any photo. While viewing the photo, click the Info button (i), click Assign a Location, then start typing. Choose your location from the list, or type it, then press Return.

iTunes

iTunes makes it easy to organize and enjoy the music, movies, and TV shows you have—and shop for the ones you want. iTunes includes Apple Music (which lets you listen to millions of songs on demand), Beats 1 live radio, and Connect, a fun way for fans and artists to interact.

It's in your library. Your iTunes library contains your music, movies, TV shows, podcasts, iTunes U content, audiobooks, apps, ringtones, and Internet radio. Just click a button in the top-left corner to change views. (If you don't see the button you're looking for, click ***).

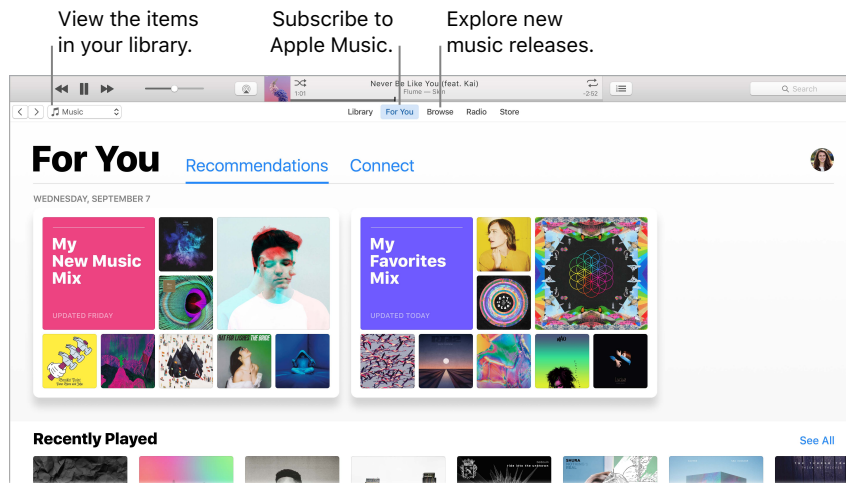

Find your new favorite song. Click For You to browse albums and playlists recommended for you based on the artists and genres you love. The reorganized, easy-to-understand sections highlight why each album or playlist was selected for you. For You also shows posts from artists you follow, so it's easier than ever to discover new music.

Browse the best of Apple Music. Click Browse to see new music and exclusive releases from Apple Music. Choose from a huge selection of playlists to find the perfect mix for any moment.

Tune in. Click Radio to tune in to Beats 1 live or listen to any episode from the Beats 1 family of shows. Explore the wide variety of music-only stations created for almost every genre of music.

Ask Siri. Say something like: "Play NPR Radio."

Tip: To play music or radio from a speaker using AirPlay, click the AirPlay icon (📶) in the menu bar and select an available speaker.

FaceTime

Make video and audio calls from your Mac with FaceTime.

 **Ask Siri.** Say something like: “Make a FaceTime call to Sharon.”

Video or audio only? Use the built-in FaceTime HD camera on your Mac to make FaceTime video calls. If it’s not convenient to make a video call, click the Audio button to make an audio-only call.

 **Tip:** While a video call is in progress, you can drag the small picture-in-picture window to any corner of the FaceTime window.

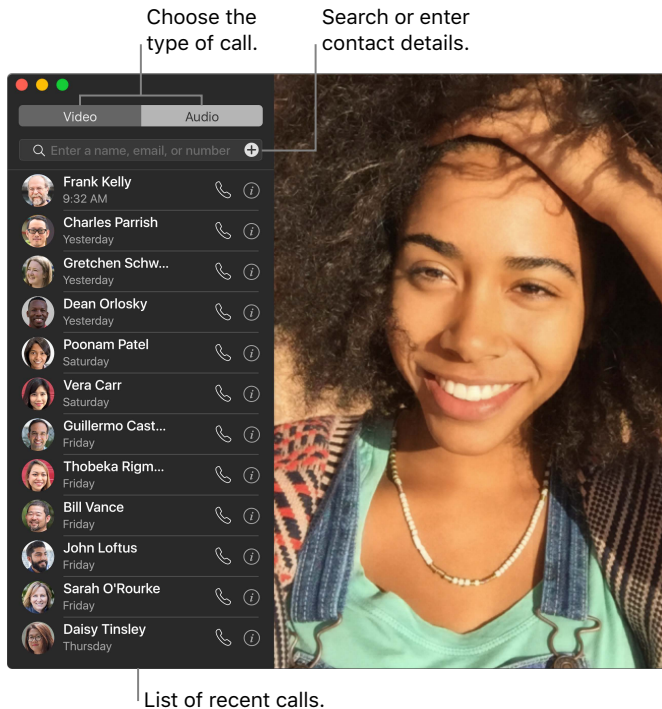

Leave a message. If your FaceTime video call is declined or unanswered, click Message to send an iMessage.

Make a phone call. If you have an iPhone with iOS 8 or later, make phone calls right from your Mac using FaceTime. Just make sure your Mac and iPhone are signed in to the same iCloud account and have the feature turned on. (On your Mac, open FaceTime, choose FaceTime > Preferences, then select “Calls from iPhone.”)

Note: A Wi-Fi connection is required in order to make or receive calls on your iMac.



Get directions and view locations using standard or satellite imagery. Or use Flyover to view select cities in 3D.

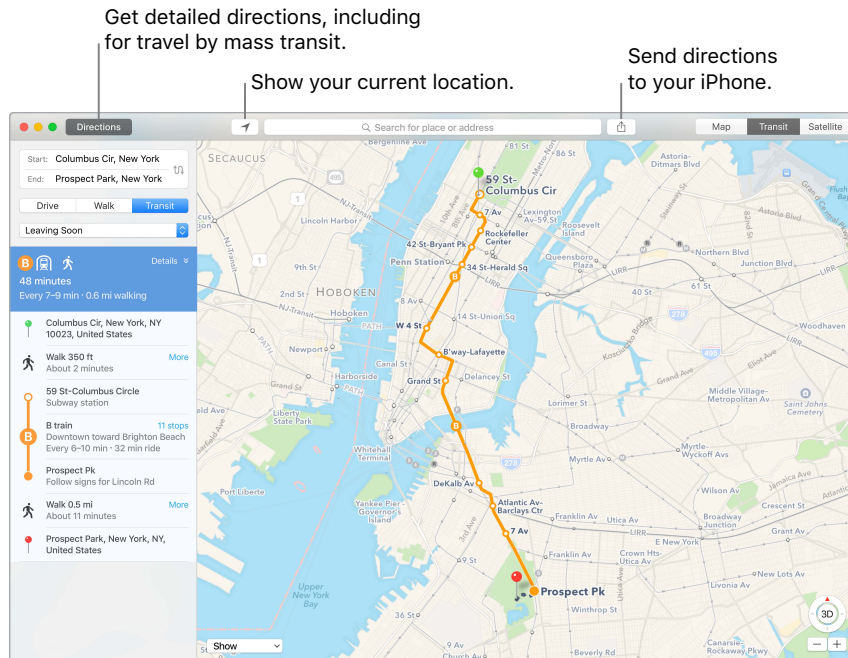

Let iPhone show you the way. Click Directions to find the best route for your destination, then click the Share button  to send the directions to your iPhone for turn-by-turn voice navigation.

Get there on public transit. Maps provides public transit information for select cities. Click Transit, then click a destination to get suggested travel routes and estimated travel time.

More than just maps. For local points of interest such as hotels and restaurants, Maps shows you phone numbers, photos, and even reviews.

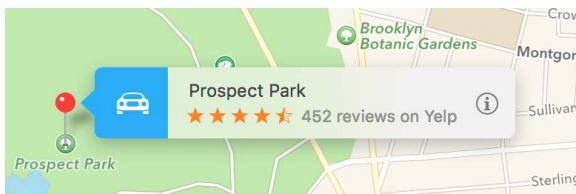

 Ask Siri. Say something like: "Find coffee near me."

WARNING: For important information about navigation and avoiding distractions that could lead to dangerous situations, see [Important safety information](#).

 **Tip:** Maps can show you what traffic is like in both Map and Satellite view. Click Show, then choose Show Traffic.



Use iBooks to read and organize your library of books, and to purchase new books on your Mac.

A bookshelf right on your Mac. Browse or search all the items in your library—or click iBooks Store to find new books and other publications. To buy, just sign in with your Apple ID: Choose Store > Sign in.

Ask Siri. Say something like: “Find books by Jane Austen.”

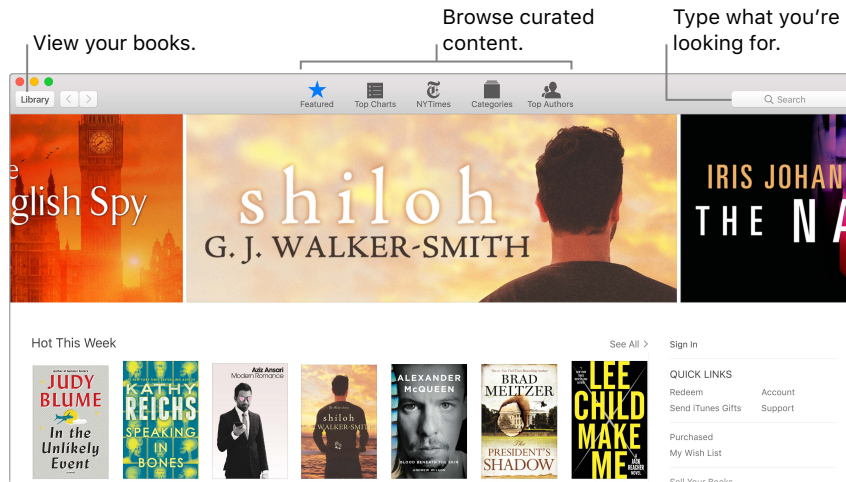

Never lose your place or your markups. Your purchased books, collections, highlights, notes, bookmarks, and the current page you’re reading are available automatically on your Mac and iOS devices, as long as you’re signed in on them with the same Apple ID.

Find your way back. You can quickly go to pages you’ve bookmarked. Click the arrow next to to view your list of bookmarks.

Tip: Change to Night mode to read more easily in low-light situations. Choose View > Theme, then choose Night, or click the Fonts button , then click the black circle.

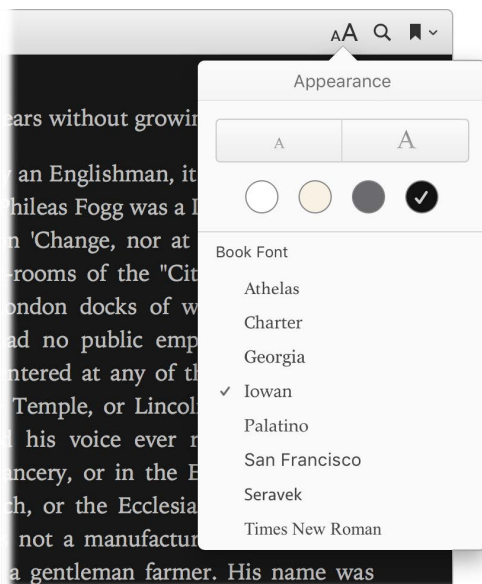



Use the Pages app to create stunning media-rich documents on your Mac. Open and edit Microsoft Word files, and easily share a link to your work with Mail or Messages, right from the toolbar.

Look good! Pages includes a variety of beautiful templates for flyers, newsletters, reports, and résumés, among others, making it easy to start your project.

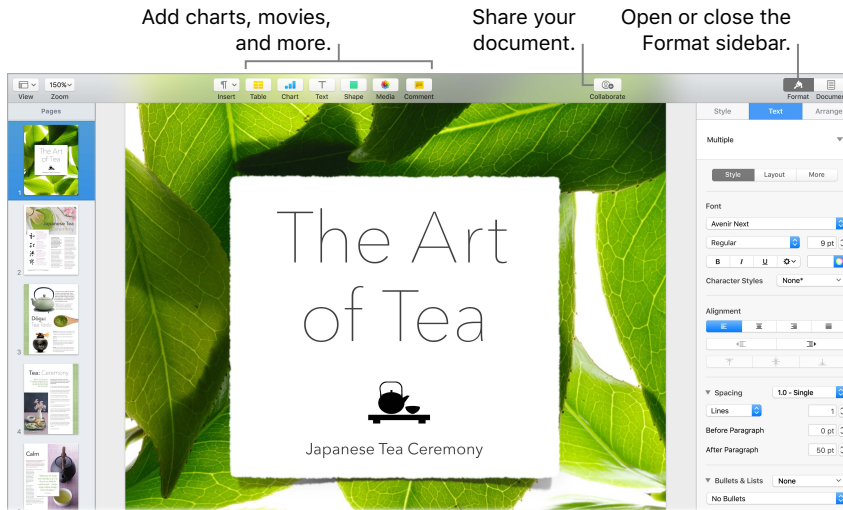

All your formatting tools, in one place. Click the Format button  in the toolbar to open the Format inspector. Select something in your document, and the formatting options for it appear.

Flow text around graphics. When you add an image to a text document, the text flows automatically around the image. You can fine-tune how the text wraps in the Format sidebar.



Move a graphic into a text block...



...and the text wraps around the graphic automatically.

Start on your Mac, finish on iPad. You can keep documents up to date across all your devices when you sign in to iCloud with the same Apple ID. So you can start composing on one device, and pick up where you left off on another.

 **Tip:** Turn on change tracking to see the changes you and others make to a document. Each person's edits and comments are color-coded, so you can see who made the change. Choose Edit > Turn on Tracking to show the change tracking toolbar.

Numbers

Use Numbers to create attractive and powerful spreadsheets on your Mac. More than 30 Apple-designed templates give you a head start creating budgets, invoices, team rosters, and more. Numbers can also open and export Microsoft Excel spreadsheets.

 **Ask Siri.** Say something like: “Show spreadsheets in downloads folder.”

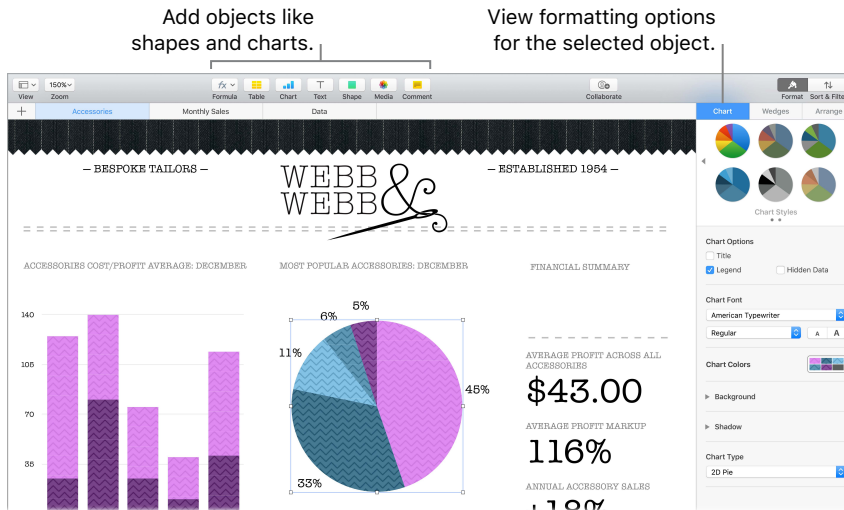

Start with a template—then add what you want. Select the sample text in the template, then type new text. To add images, drag a graphic file from your Mac onto the placeholder image.

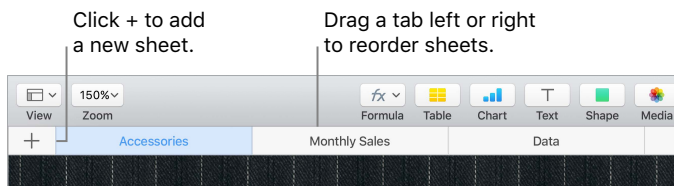

Get organized with sheets. Use multiple sheets or tabs to show different views of your information. For example, use one sheet for your budget, another for a table, and a third for notes. Click + to add a new sheet. Drag a tab left or right to reorder sheets.



Formulas are a snap. Get built-in help for more than 250 powerful functions—just type the equal sign (=) in a cell, and you see a list of all the functions and their descriptions in the sidebar. Start typing a formula to get instant suggestions.

 **Tip:** To get instant calculations on a series of values, select the range of cells containing the values, then look down at the bottom of the window. You’ll see the sum, average, minimum, maximum, and count of the selected values. Click the Settings button  to see even more options.

Keynote

Create professional, cutting-edge presentations with Keynote. Start with one of the more than 30 predesigned themes and make it your own by adding text, new objects, and updating the color scheme.

Organize visually. Use the slide navigator on the left to quickly add, delete, or rearrange slides. Click a slide to see it in the main window, drag a slide to change its order, or select it and press Delete to remove it.

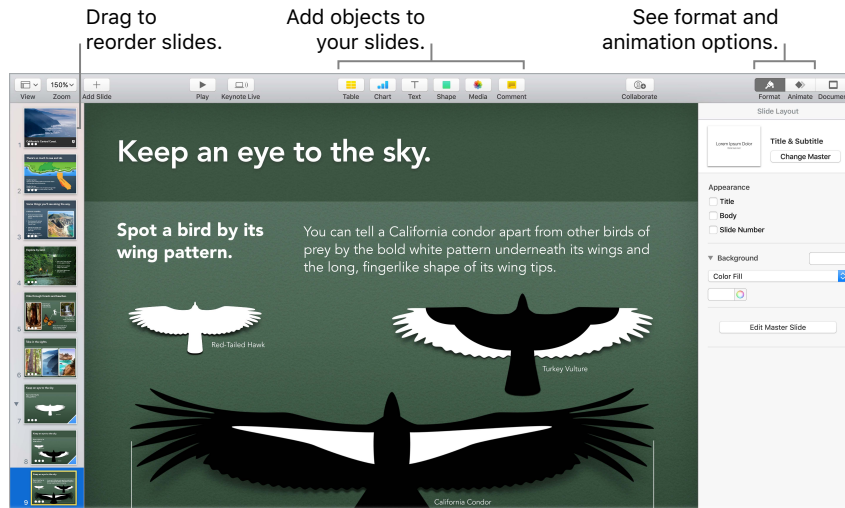

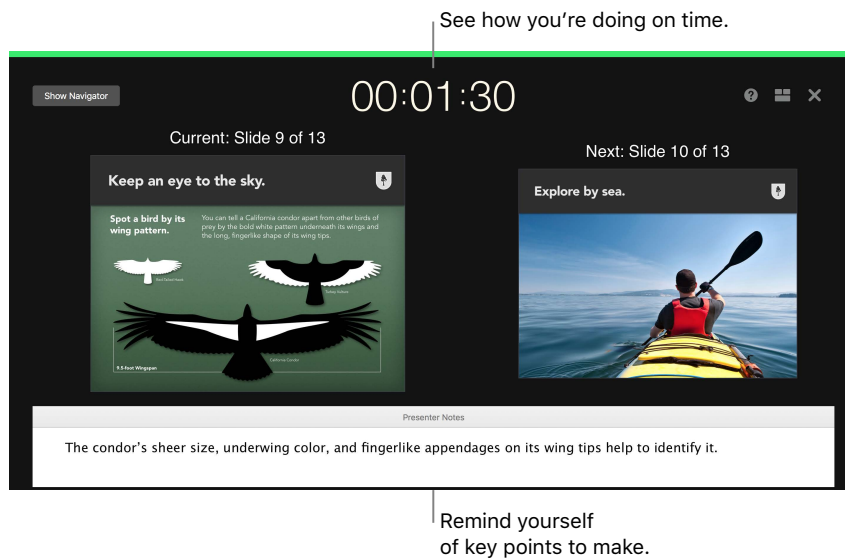

Practice makes perfect. To rehearse your presentation, choose Play > Rehearse Slideshow. You'll see each slide along with your notes—and a clock to keep you on track.



Share your presentation. If your manager wants to review your presentation or you want to share it with others on a conference call, choose Share > Send a Copy to send a copy by Mail, Messages, AirDrop, or even social media.

Follow the bouncing ball. Get their attention by animating an object on a slide. Select the object, click Animate in the toolbar, click Action in the sidebar, then click Add an Effect.

 **Tip:** You can embed a video in your presentation. Click where you want it to be, then click the Media button  in the toolbar. Click Movies, find the movie you want, then drag the file to your slide.



iMovie lets you turn your home videos into beautiful movies and Hollywood-style trailers that you can share with a few quick clicks.

Import a video. Import video from your iPhone, iPad, or iPod touch, from a camera, or from media files already on your Mac. iMovie creates a new library and event for you.



Record video with the built-in camera. Use the FaceTime camera on your Mac to record video and add it to your project. Select an event in the sidebar, click Import in the toolbar, select FaceTime HD Camera, then click the Record button to start and stop recording.

Create Hollywood-style trailers. Make clever trailers, complete with animated graphics and soaring soundtracks. Just add photos and video clips and customize the credits. To get started, click the New button **+**, click Trailer, choose a template from the Trailer window, then click Create. Add the cast and credits in the Outline tab, and add your own photos and videos in the Storyboard tab.



Tip: Shooting video with a handheld device can produce shaky results, but you can stabilize the video so the playback is smoother. Select the shaky clip in the timeline, click the Stabilization button , then click Stabilize Shaky Video.

GarageBand

GarageBand is an app for creating, recording, and sharing your music. It has everything you need to learn to play an instrument, write music, or record a song—your own home recording studio.

Create a new project. You can start with a song template, select a tempo, key, and other options, then click Record and start playing. Build your song—for example, with different tracks and loops. Click Quick Help  and hold the pointer over items to learn what they are and how they work.



No more excuses—learn to play. GarageBand comes with a lesson to start learning piano and one for guitar. Open the Lesson Store in the Project Chooser to view more lessons to download or purchase—many from famous musicians.

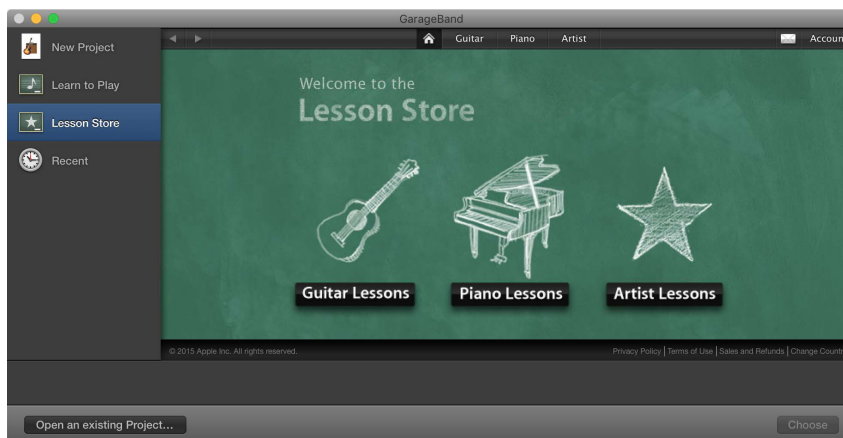

Record your voice. Connect a microphone, choose Track > New Track, then select the microphone under Audio. Click the triangle next to Details to set options for input, output, and monitoring, then click Create. Click the Record button to start and the Play button to stop recording. Don't forget to sing!

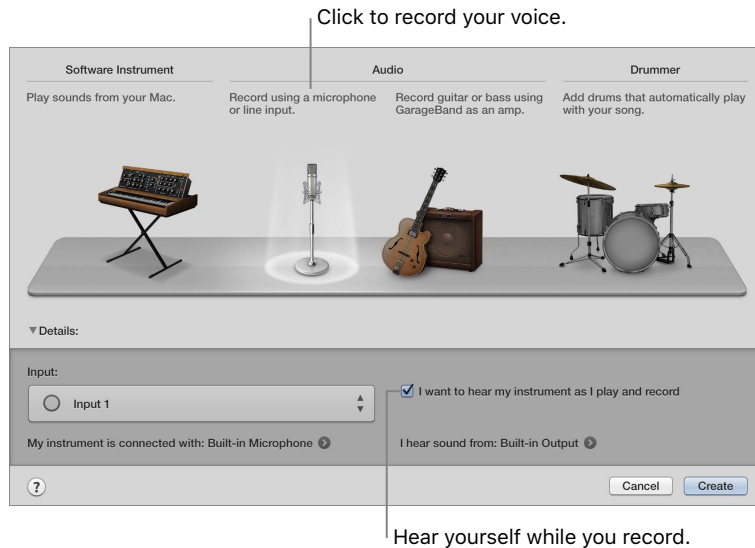

Tip: Make your own ringtones, then sync them to your iPhone using iTunes. Choose File > New, select Ringtone, click Choose, then import a file to use. Customize the ringtone the way you want, then choose Share > Ringtone to iTunes.

App Store

Search the App Store to find and download apps, and get the latest updates for your apps.

Find the perfect app. Know exactly what you're looking for? Type the name in the search field, then press Return. Or click Top Charts to see the most popular apps.



Ask Siri. Say something like: "Find apps by Apple."

All you need is an Apple ID. To download apps, just sign in with your Apple ID—choose Store > Sign In, or click Sign In on the right side of the window. If you don't have an Apple ID yet, choose Store > Create Account. If you can't remember your password, click the Forgot link to recover it.

Get the latest updates. If you see a badge on the App Store icon in the Dock, there are updates available for your apps or macOS. Click the icon to open App Store, then click Updates in the toolbar.

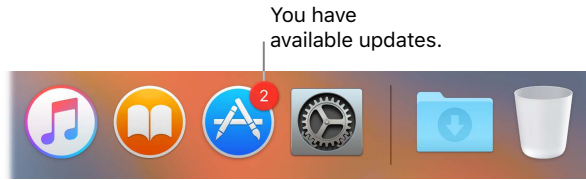

Tip: You can spread the word about your favorite apps to your friends. While viewing an app, click the down arrow next to the price, then choose Tell a Friend.

Find answers

4

Mac Help

Mac Help has a lot more information about how to use your iMac.

Get help. Click the Finder icon  in the Dock, then click the Help menu in the menu bar and choose Mac Help. Or type a question or term in the search field, then choose a topic from the results list.

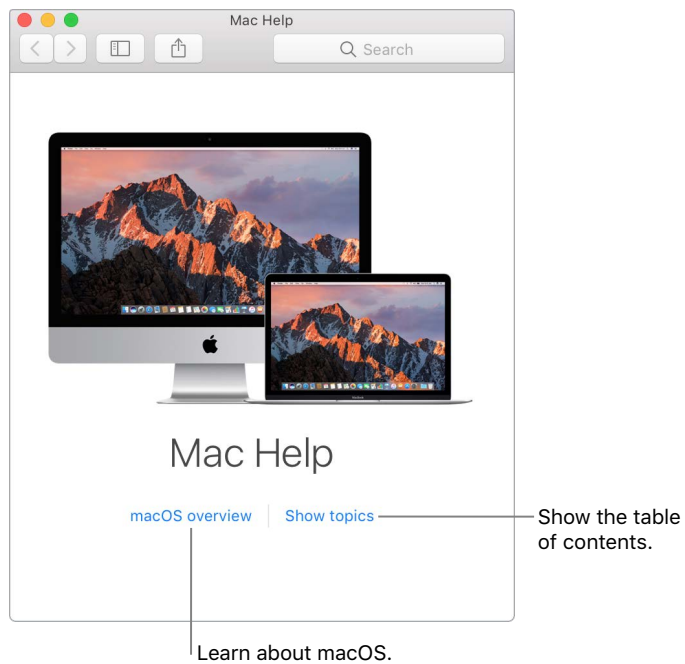

Explore topics. To find a topic in Mac Help, you can browse or search. To browse, click "Show topics" to see the list of topics, then click a topic to read it. Or type what you want to find in the search field to go right to your answer.

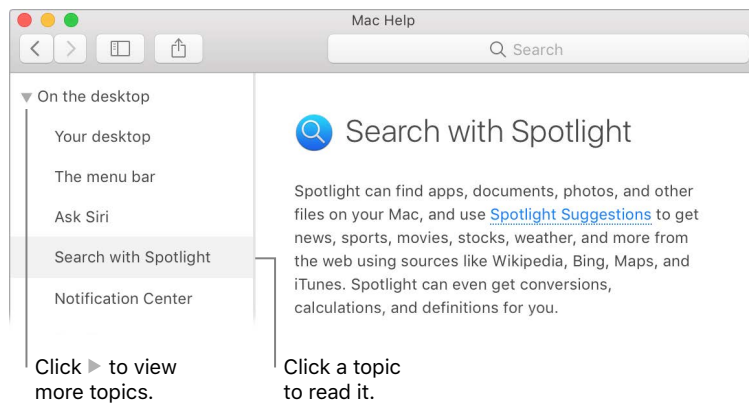

Find out what's new. Click the Help menu, then choose What's New in macOS to find out more about the latest features of macOS.

 **Tip:** If you can't remember the location of a menu item in an app, search for it in Help. Place the pointer over the result, and an arrow shows you the command.

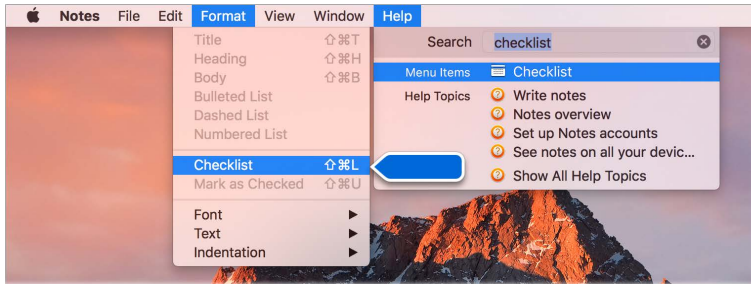

Common questions

How do I get support for my iMac? Go to www.apple.com/support/imac/intel.

Where's my serial number? Choose Apple menu > About This Mac. The serial number is the last item in the list. If your computer isn't turned on, you can find the serial number printed on the bottom of the iMac stand.

 **Ask Siri.** Say something like: "What's my computer's serial number?"

How do I get help for an app? When you're using the app, click the Help menu in the menu bar at the top of the screen.

Where is the safety information for my iMac? See [Important safety information](#).

How do I find the technical specifications? Go to www.apple.com/imac/specs or choose Apple menu > About This Mac and click the buttons at the top for displays, storage, and memory.

 **Ask Siri.** Ask Siri for information about your Mac. Say something like:

- "How fast is my Mac?"
- "How much memory does my Mac have?"
- "How much free space do I have on my Mac?"
- "How much iCloud storage do I have left?"

How do I check my disk for problems? Use Disk Utility. See the Apple Support article support.apple.com/HT201639.

Keyboard shortcuts

You can press key combinations to do things on your iMac that you'd normally do with a trackpad, mouse, or other device. Here's a list of commonly used keyboard shortcuts.

Shortcut	Description
Command-X	Cut the selected item and copy it to the Clipboard.
Command-C	Copy the selected item to the Clipboard.
Command-V	Paste the contents of the Clipboard into the current document or app.
Command-Z	Undo the previous command. Press Command-Z again to Redo.
Command-A	Select All items.
Command-F	Open a Find window, or Find items in a document.
Command-G	Find Again, or find the next occurrence of the item you're searching for. Press Command-Shift-G to find the previous occurrence.
Command-H	Hide the windows of the front app. Press Command-Option-H to view the front app but hide all other apps.
Command-M	Minimize the front window to the Dock. Press Command-Option-M to minimize all windows of the front app.
Command-N	Open a New document or window.
Command-O	Open the selected item, or open a dialog to select a file to open.
Command-P	Print the current document.
Command-S	Save the current document.
Command-W	Close the front Window. Press Command-Option-W to close all windows of the app.
Command-Q	Quit the app.
Command-Option-Esc	Choose an app to Force Quit.
Command-Tab	Switch to the next most recently used app among your open apps.
Command-Shift-3	Take a Screenshot of the entire screen. Press Command-Shift-4 to take a screenshot of a selected area of the screen.

If you switched to the Mac from a PC, check out www.apple.com/support/macbasics/pctomac for a list of Mac keyboard shortcuts and the differences between Mac and Windows keyboards. For a more complete list of keyboard shortcuts, see the Apple Support article support.apple.com/HT201236.

Replace memory

Overview

You can replace memory in the 27-inch iMac by following the instructions in this section.

Important: The memory in the 21.5-inch iMac is not user-replaceable and can't be upgraded after purchase. The 21.5-inch iMac can have a maximum of 16 GB of memory installed. Do not attempt to open your 21.5-inch iMac to replace or upgrade its memory.

Your 27-inch iMac comes with at least 8 gigabytes (GB) of 1867 MHz DDR3 memory installed as two 4 GB memory modules. You can replace or install additional 4 GB or 8 GB memory modules for up to a maximum of 32 GB. Use Small Outline Dual Inline Memory Modules (SO-DIMM) that meet all the following specifications:

- PC3-15000
- Unbuffered and nonparity
- 204-pin 1867 MHz DDR3 SDRAM

WARNING: Apple recommends that you have an Apple-certified technician install memory. See [More resources, service, and support](#) for information about how to contact Apple for service. If you attempt to install memory and damage your equipment, that damage isn't covered by the limited warranty on your iMac.

Install memory

The 27-inch iMac has four memory slots. Two are filled with at least a 4 GB memory module. You can install additional memory in the free slots or replace the memory in the filled slots with 2 GB, 4 GB, or 8 GB memory modules, for up to 32 GB of memory.

You can purchase additional memory from an Apple Authorized Reseller.

WARNING: Always shut down your iMac and remove the power cord before installing memory. Do not attempt to install memory while your iMac is plugged in. If you've been using your iMac, wait ten minutes after shutdown to let the internal components cool before continuing.

Install memory in your 27-inch iMac

- 1 Turn off your iMac by choosing Apple menu > Shut Down.
- 2 Disconnect all cables and the power cord from your iMac.
- 3 Place a soft, clean towel or cloth on your work surface. Hold the sides of your iMac and lay it down so that the screen rests on the surface and the bottom faces you.
- 4 Open the memory compartment door by pressing the small gray button located just above the AC power port.



The memory compartment door opens as the button is pushed in.

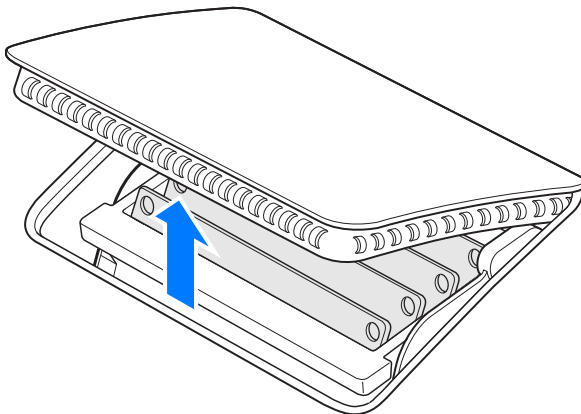

- 5 Remove the memory compartment door and set it aside.

A diagram on the bottom of the door shows the orientation of the memory modules and the memory cage levers.

- 6 Locate the levers on the sides of the memory cage. Push the levers outward to release the cage.

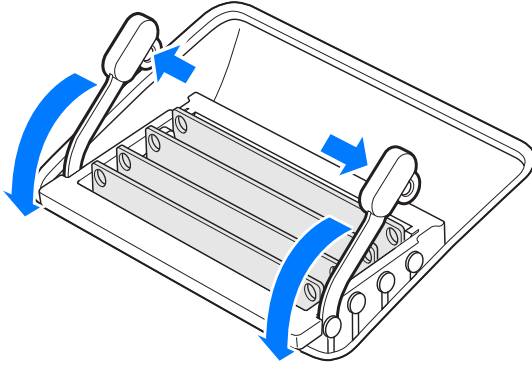

- 7 Pull the levers toward you to give you access to the memory module slots.

- 8 Remove a memory module—handle it carefully by its edges and pull it straight up and out.

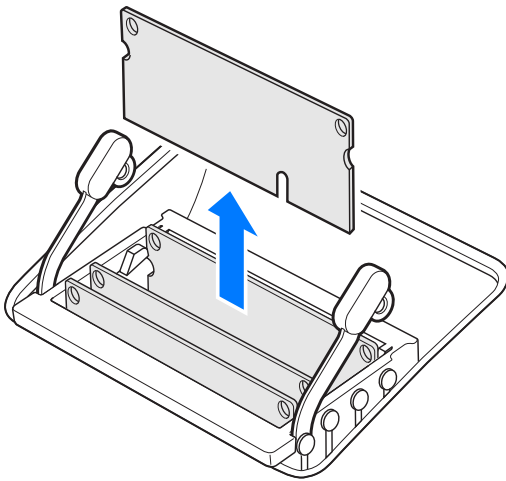

- 9 With the notch on the bottom and toward the right side, replace or install a memory module by inserting it into the slot. Press firmly and evenly until you feel a slight click.

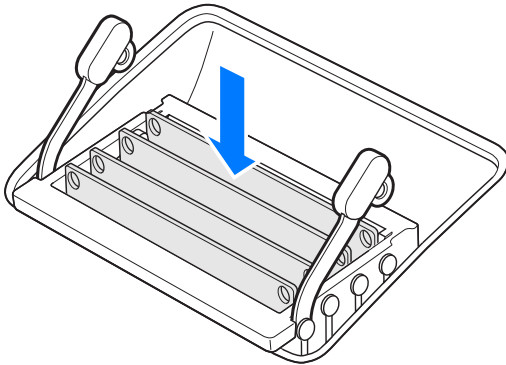

- 10 After you've installed all the memory modules, push the memory cage levers down into the compartment until they click back into place.

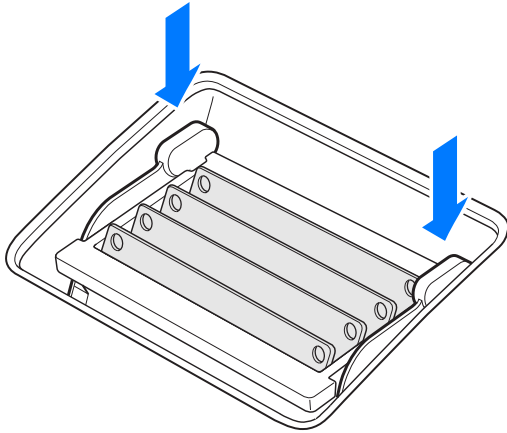

- 11 Replace the memory compartment door, then press it firmly.
- 12 Hold your iMac by its sides and return it to a standing position. Reconnect the cables and power cord.
- 13 Press the power button on the back of your iMac to turn it on.

Make sure your iMac recognizes the new memory

After you install memory, check that your iMac recognizes the new memory.

- 1 Start up your iMac.
- 2 When you see the macOS desktop, choose Apple menu > About This Mac.

You'll see the total amount of memory installed in your iMac. For a detailed view of the amount of memory installed, click System Report, then click Memory on the left under Hardware.

If the memory you installed doesn't meet specifications, your iMac will sound three tones every five seconds. If this happens, shut down your iMac and check the installation instructions again to make sure that the memory is compatible and installed correctly. If you still have problems, remove the memory and consult the support information that came with the memory or contact the vendor who provided the memory.

More resources, service, and support

You can find more information about your iMac in System Report, Apple Diagnostics, and through online resources.

System Report. To get information about your iMac, use System Report. It shows you what hardware and software is installed, the serial number and operating system version, how much memory is installed, and more. To open System Report, choose Apple menu > About This Mac, then click System Report.

Apple Diagnostics. You can use Apple Diagnostics to help determine if there's a problem with one of the computer's components, such as the memory or processor. Apple Diagnostics helps to identify the potential source of a hardware issue and provides first steps to try and resolve it. Apple Diagnostics will also help you get in touch with Apple Support if you need more help.

Before using Apple Diagnostics, disconnect any external devices, such as a hard disk or external display. Be sure your iMac is connected to the Internet.

To start Apple Diagnostics, restart your iMac and hold down the D key as it starts up. If prompted, select the language for your location. Press the Return key or click the right arrow button. The basic Apple Diagnostics test takes a few minutes to complete. If issues are found, a description of the issue appears with additional instructions. Make a note of any reference codes before you exit Apple Diagnostics.

Online resources. For online service and support information, see www.apple.com/support. You can learn about Apple products, view online manuals, and check for software updates. Connect with other Apple users, and get service, support, and professional advice from Apple.

AppleCare support. If you need assistance, AppleCare representatives can help you with installing and opening apps, and with troubleshooting. Call the support center number nearest you (the first 90 days are complimentary). Have the purchase date and your iMac serial number ready when you call.

Your 90 days of complimentary telephone support begins on the date of purchase.

Country	Phone number	Web address
United States	1-800-275-2273	www.apple.com/support
Australia	(61) 1-300-321-456	www.apple.com/au/support
Canada	1-800-263-3394	English: www.apple.com/ca/support French: www.apple.com/ca/fr/support
Ireland	1-800-804-062	www.apple.com/ie/support
New Zealand	00800-7666-7666	www.apple.com/nz/support
United Kingdom	(44) 0844 209 0611	www.apple.com/uk/support

Telephone numbers are subject to change, and local and national telephone rates may apply. A complete list is available on the web at www.apple.com/support/contact/phone_contacts.html.

Safety, handling, and support

5

Important safety information



WARNING: Failure to follow these safety instructions could result in fire, electric shock, or other injuries, or damage to your iMac or other property. Read all safety information below before using your iMac.

Handling. Set up your iMac on a hard, stable work surface that allows for adequate air circulation under and around the computer. Never push objects into the ventilation openings. Your iMac can be damaged if dropped, burned, punctured, or crushed, or if it comes in contact with liquids, oils, and lotions. Don't use a damaged iMac, such as one with a cracked screen, as it may cause injury.

Liquid exposure. Keep your iMac away from sources of liquid, such as drinks, oils, lotions, washbasins, bathtubs, shower stalls, and so on. Protect your iMac from dampness, humidity, or wet weather, such as rain, snow, and fog.

Power. Unplug the power cord (by pulling the plug, not the cord) and disconnect the Ethernet cable or phone cord if any of the following conditions exist:

- You want to add memory (you can replace memory yourself only in the 27-inch iMac).
- The power cord or plug becomes frayed or otherwise damaged.
- You spill something into the case.
- Your iMac is exposed to rain or excess moisture.
- Your iMac has been dropped, or the case has been damaged.
- You suspect that your iMac needs service or repair.
- You want to clean the case (use only the recommended procedure, described later in this document).

Important: The only way to turn off power completely is to unplug the power cord. Make sure at least one end of the power cord is within easy reach so that you can unplug your iMac when you need to.

Power specifications (21.5-inch model):

- *Voltage:* 100 to 240 V AC
- *Current:* 3 A, maximum
- *Frequency:* 50 to 60 Hz

Power specifications (27-inch model):

- *Voltage:* 100 to 240 V AC
- *Current:* 4 A, maximum
- *Frequency:* 50 to 60 Hz

WARNING: Your AC cord has a three-wire grounding plug (a plug that has a grounding pin). This plug fits only a grounded AC outlet. If you're unable to insert the plug into an outlet because the outlet isn't grounded, contact a licensed electrician to replace the outlet with a properly grounded one. Do not defeat the purpose of the grounding pin.

Hearing loss. Listening to sound at high volumes may damage your hearing. Background noise, as well as continued exposure to high volume levels, can make sounds seem quieter than they actually are. Use only compatible earbuds, headphones, or earpieces with your iMac. Turn on the audio and check the volume before inserting anything into your ear. For more information about hearing loss, see www.apple.com/sound.



WARNING: To prevent possible hearing damage, do not listen at high volume levels for long periods.

Repairing. Your iMac doesn't have any user-serviceable parts, except for the memory, which is user-replaceable in 27-inch models only. Do not attempt to replace or repair any components inside your iMac. If your iMac needs service, contact Apple or an Apple Authorized Service Provider. If you open your iMac or install items other than memory in 27-inch models, you risk damaging your computer. Such damage isn't covered by the limited warranty on your iMac.

Navigation. Maps, directions, and location-based apps depend on data services. These data services are subject to change and may not be available in all areas, resulting in maps, directions, or location-based information that may be unavailable, inaccurate, or incomplete. Compare the information provided on iMac to your surroundings and defer to posted signs to resolve any discrepancies. Do not use these services while performing activities that require your full attention. Always comply with posted signs and the laws and regulations in the areas where you are using iMac and always use common sense.

Radio frequency exposure. iMac uses radio signals to connect to wireless networks. For information about radio frequency (RF) energy resulting from radio signals and steps you can take to minimize exposure, see www.apple.com/legal/rfexposure.

Medical device interference. iMac contains components and radios that emit electromagnetic fields, which may interfere with pacemakers, defibrillators, or other medical devices. Maintain a safe distance of separation between your medical device and iMac. Consult your physician and medical device manufacturer for information specific to your medical device. If you suspect iMac is interfering with your pacemaker or any other medical device, stop using iMac.

Medical conditions. If you have a medical condition that you believe could be affected by using iMac (for example, seizures, blackouts, eyestrain, or headaches), consult with your physician prior to using iMac.

Repetitive motion. When you perform repetitive activities such as typing or playing games on iMac, you may experience discomfort in your hands, arms, wrists, shoulders, neck, or other parts of your body. If you experience discomfort, stop using iMac and consult a physician.

High-consequence activities. iMac is not intended for use where the failure of the computer could lead to death, personal injury, or severe environmental damage.

Explosive atmospheres. Charging or using iMac in any area with a potentially explosive atmosphere, such as areas where the air contains high levels of flammable chemicals, vapors, or particles (such as grain, dust, or metal powders), may be hazardous. Obey all signs and instructions.

Important handling information

Operating environment. Operating your iMac outside these ranges may affect performance:

- *Operating temperature:* 50° to 95° F (10° to 35° C)
- *Storage temperature:* -4° to 113° F (-25° to 45° C)
- *Relative humidity:* 5% to 90% (noncondensing)
- *Operating altitude:* Tested up to 10,000 feet (0 to 3048 meters)

Do not operate your iMac in areas with significant amounts of airborne dust, or smoke from cigarettes, cigars, ashtrays, stoves, or fireplaces, or near an ultrasonic humidifier using unfiltered tap water. Tiny airborne particles produced by smoking, cooking, burning, or using an ultrasonic humidifier with unfiltered water may, in rare instances, enter the ventilation openings of your iMac and, under certain conditions, result in a slight haze on the inside surface of the glass panel that covers the iMac display.

Carrying your iMac. Before you lift or reposition your iMac, shut it down and disconnect all cables and cords. To lift your iMac, hold its sides.

Using connectors and ports. Never force a connector into a port. When connecting a device, make sure the port is free of debris, that the connector matches the port, and that you have positioned the connector correctly in relation to the port.

Storing your iMac. If you are going to store your iMac for an extended period of time, keep it in a cool location (ideally, 71° F or 22° C).

Cleaning your iMac. When cleaning the outside of your iMac and its components, first shut down your iMac, then unplug all cords and cables. Then dampen a clean, soft, lint-free cloth to wipe the iMac exterior. Avoid getting moisture in any openings. Don't spray liquid directly on the computer. Don't use aerosol sprays, solvents, abrasives, or cleaners containing hydrogen peroxide that might damage the finish.

Cleaning the iMac display. To clean your iMac screen, first shut down your iMac, then unplug all cords and cables. Dampen a clean, soft, lint-free cloth with just water and wipe the screen. Don't spray liquid directly on the screen.

Cleaning the Magic Mouse 2. Turn off the mouse, then unplug the cable (if necessary). To clean the outside of your mouse, use a clean, soft, lint-free cloth that's been lightly moistened with water. Don't get moisture in any openings or use aerosol sprays, solvents, or abrasives.

Cleaning the Magic Keyboard. Turn off the keyboard, then unplug the cable (if necessary). To clean the outside of your keyboard, use a clean, soft, lint-free cloth that's been lightly moistened with water. Don't get moisture in any openings or use aerosol sprays, solvents, or abrasives.

Understanding ergonomics

When you use the keyboard and mouse, your shoulders should be relaxed. Your upper arm and forearm should form an angle that is slightly greater than a right angle, with your wrist and hand in roughly a straight line.

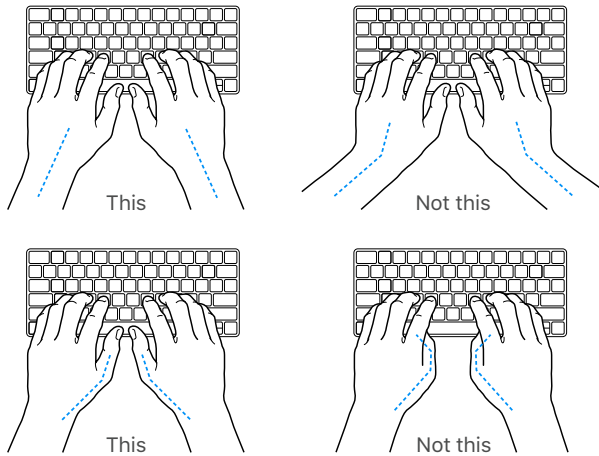

Change hand positions often to avoid fatigue. Some computer users might develop discomfort in their hands, wrists, or arms after intensive work without breaks. If you begin to develop chronic pain or discomfort in your hands, wrists, or arms, consult a qualified health specialist.

Mouse or optional trackpad. Position the mouse or trackpad at the same height as the keyboard and within a comfortable reach.

Chair. An adjustable chair that provides firm, comfortable support is best. Adjust the height of the chair so your thighs are horizontal and your feet are flat on the floor. The back of the chair should support your lower back (lumbar region). Follow the manufacturer's instructions for adjusting the backrest to fit your body properly.

Built-in display. Arrange the display so that the top of the screen is slightly below eye level when you're sitting at the keyboard. The best distance from your eyes to the screen is up to you, although most people seem to prefer 18 to 28 inches (45 to 70 cm).

Position the display to minimize glare and reflections from overhead lights and windows. The stand lets you set the display at the best angle for viewing, helping to reduce or eliminate glare from lighting sources you can't move.

For more information about ergonomics, see www.apple.com/about/ergonomics.

FCC regulatory compliance

This device complies with part 15 of the FCC rules. Operation is subject to the following two conditions: (1) This device may not cause harmful interference, and (2) this device must accept any interference received, including interference that may cause undesired operation.

Note: This equipment has been tested and found to comply with the limits for a Class B digital device, pursuant to part 15 of the FCC Rules. These limits are designed to provide reasonable protection against harmful interference in a residential installation. This equipment generates, uses, and can radiate radio frequency energy and, if not installed and used in accordance with the instructions, may cause harmful interference to radio communications. However, there is no guarantee that interference will not occur in a particular installation. If this equipment does cause harmful interference to radio or television reception, which can be determined by turning the equipment off and on, the user is encouraged to try to correct the interference by one or more of the following measures:

- Reorient or relocate the receiving antenna.
- Increase the separation between the equipment and receiver.
- Connect the equipment to an outlet on a circuit different from that to which the receiver is connected.
- Consult the dealer or an experienced radio/TV technician for help.

Important: Changes or modifications to this product not authorized by Apple could void the electromagnetic compatibility (EMC) and wireless compliance and negate your authority to operate the product.

This product has demonstrated EMC compliance under conditions that included the use of compliant peripheral devices and shielded cables (including Ethernet network cables) between system components. It is important that you use compliant peripheral devices and shielded cables between system components to reduce the possibility of causing interference to radios, television sets, and other electronic devices.

If necessary, contact Apple or take your iMac to an Apple-authorized repair center, such as an Apple Authorized Service Provider. Or consult an experienced radio/television technician for additional suggestions.

Responsible party (contact for FCC matters only):

Apple Inc. Corporate Compliance
1 Infinite Loop, MS 91-1EMC
Cupertino, CA 95014

Canadian regulatory compliance

This device complies with Industry Canada license-exempt RSS standard(s). Operation is subject to the following two conditions: (1) this device may not cause interference, and (2) this device must accept any interference, including interference that may cause undesired operation of the device.

Operation in the band 5150–5250 MHz is only for indoor use to reduce the potential for harmful interference to co-channel mobile satellite systems.

Users are advised that high-power radars are allocated as primary users (that is, priority users) of the bands 5250–5350 MHz and 5650–5850 MHz and these radars could cause interference and/or damage to LE-LAN devices.

Le présent appareil est conforme aux CNR d'Industrie Canada applicables aux appareils radio exempts de licence. L'exploitation est autorisée aux deux conditions suivantes : (1) l'appareil ne doit pas produire de brouillage, et (2) l'utilisateur de l'appareil doit accepter tout brouillage radioélectrique subi, même si le brouillage est susceptible d'en compromettre le fonctionnement.

La bande 5150–5250 MHz est réservée uniquement pour une utilisation à l'intérieur afin de réduire les risques de brouillage préjudiciable aux systèmes de satellites mobiles utilisant les mêmes canaux.

Les utilisateurs sont avisés que les utilisateurs de radars de haute puissance sont désignés utilisateurs principaux (c.-à-d., qu'ils ont la priorité) pour les bandes 5250–5350 MHz et 5650–5850 MHz et que ces radars pourraient causer du brouillage et/ou des dommages aux dispositifs LAN-EL.

Industry Canada Statement

Complies with CAN ICES-3 (B)/NMB-3(B).

EU compliance statement



Hereby, Apple Inc. declares that this wireless device is in compliance with the essential requirements and other relevant provisions of the R&TTE Directive.

A copy of the EU Declaration of Conformity is available at www.apple.com/euro/compliance.

Apple's EU representative is Apple Distribution International, Hollyhill Industrial Estate, Cork, Ireland.

This device can be used in the European Community.

European Community Restrictions

This device is restricted to indoor use in the 5150 to 5350 MHz frequency range.

ENERGY STAR® Compliance Statement



As an ENERGY STAR partner, Apple has determined that standard configurations of this product meet the ENERGY STAR guidelines for energy efficiency. The ENERGY STAR program is a partnership with electronic equipment manufacturers to promote energy-efficient products. Reducing energy consumption of products saves money and helps conserve valuable resources.

iMac is shipped with power management enabled with the computer set to sleep after 10 minutes of user inactivity. To wake your computer, click the mouse or press any key on the keyboard. To change this setting, click the System Preferences icon  in the Dock, then click Energy Saver.

iMac meets the ENERGY STAR guidelines for energy efficiency. Reducing energy consumption saves money and helps conserve valuable resources. For more information about ENERGY STAR, go to www.energystar.gov.

Apple and the environment

At Apple, we recognize our responsibility to minimize the environmental impacts of our operations and products.

For information, go to www.apple.com/environment.

Regional disposal and recycling information



This symbol indicates that this product and/or battery should not be disposed of with household waste. When you decide to dispose of this product and/or its battery, do so in accordance with local environmental laws and guidelines.

For information about Apple's recycling program, recycling collection points, restricted substances, and other environmental initiatives, visit www.apple.com/environment.

Información sobre eliminación de residuos y reciclaje

El símbolo de arriba indica que este producto y/o su batería no debe desecharse con los residuos domésticos. Cuando decida desechar este producto y/o su batería, hágalo de conformidad con las leyes y directrices ambientales locales. Para obtener información sobre el programa de reciclaje de Apple, puntos de recolección para reciclaje, sustancias restringidas y otras iniciativas ambientales, visite www.apple.com/la/environment o www.apple.com/mx/environment.

Brasil—Informações sobre descarte e reciclagem

O símbolo acima indica que este produto e/ou sua bateria não devem ser descartados no lixo doméstico. Quando decidir descartar este produto e/ou sua bateria, faça-o de acordo com as leis e diretrizes ambientais locais. Para informações sobre substâncias de uso restrito, o programa de reciclagem da Apple, pontos de coleta e telefone de informações, visite www.apple.com/br/environment.

European Union—Disposal Information

The symbol above means that according to local laws and regulations your product and/or its battery shall be disposed of separately from household waste. When this product reaches its end of life, take it to a collection point designated by local authorities. The separate collection and recycling of your product and/or its battery at the time of disposal will help conserve natural resources and ensure that it is recycled in a manner that protects human health and the environment.

Software License Agreement

Use of iMac constitutes acceptance of the Apple and third-party software license terms found at www.apple.com/legal/sla.

🍏 Apple Inc.

© 2016 Apple Inc. All rights reserved.

Use of the “keyboard” Apple logo (Option-Shift-K) for commercial purposes without the prior written consent of Apple may constitute trademark infringement and unfair competition in violation of federal and state laws.

Apple, the Apple logo, AirDrop, AirPlay, AirPort, AirPort Time Capsule, AirPrint, Apple Music, Apple Pay, Apple TV, Apple Watch, FaceTime, Finder, FireWire, Flyover, GarageBand, Handoff, iBooks, iMac, iMessage, iMovie, iPad, iPhone, iPod, iPod touch, iTunes, iTunes U, Keynote, Launchpad, Lightning, Mac, Magic Mouse, Magic Trackpad, Mission Control, Numbers, Pages, Photo Booth, Safari, Siri, Spaces, Spotlight, and Time Machine are trademarks of Apple Inc., registered in the U.S. and other countries.

macOS is a trademark of Apple Inc.

AppleCare, Apple Store, App Store, iCloud, iTunes Radio, and iTunes Store are service marks of Apple Inc., registered in the U.S. and other countries.

iBooks Store is a service mark of Apple Inc.

Apple
1 Infinite Loop
Cupertino, CA 95014-2084
408-996-1010
www.apple.com

iOS is a trademark or registered trademark of Cisco in the U.S. and other countries and is used under license.

The Bluetooth® word mark and logos are registered trademarks owned by Bluetooth SIG, Inc. and any use of such marks by Apple Inc. is under license.

ENERGY STAR® is a U.S. registered trademark.

Other company and product names mentioned herein may be trademarks of their respective companies.

Every effort has been made to ensure that the information in this manual is accurate. Apple is not responsible for printing or clerical errors.

Some apps are not available in all areas. App availability is subject to change.

019-00301/2016-09