

D Series

DESTINATION SIGNS

ASDS SUPPLEMENT SIGNS

D1-100 to D14-102

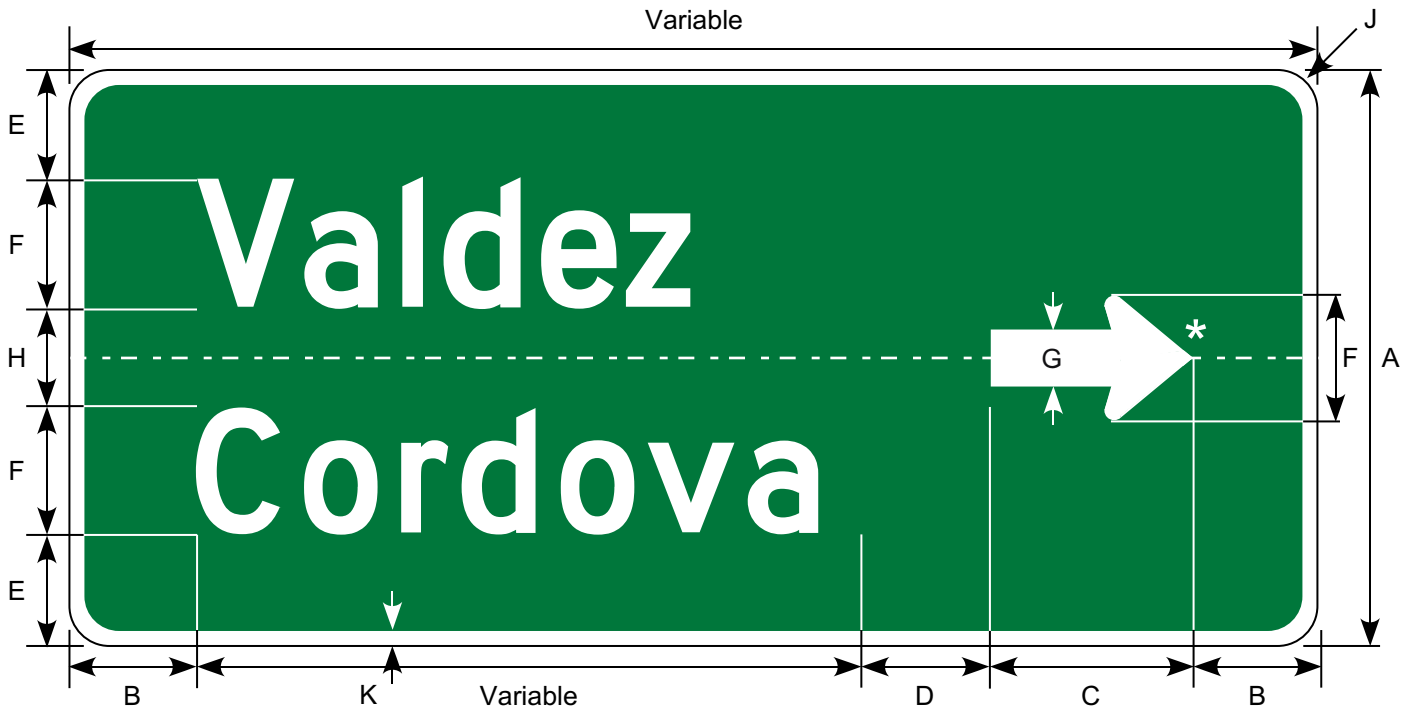

Border and Legend: White
Background: Green

*See Appendix B-1 for Standard Arrow Details.

Letter Size (inches)	Dimensions (inches)									
	A	B	C	D	E	F	G	H	K	J
6 / 4.5	24	6.0	9.56	6±	3.0	6D	2.6	6.00	0.75	1.5
8 / 6	36	8.0	12.75	8±	7.0	8D	3.48	6.0	1.0	2.25
10.7 / 8	48	11	17.25	11±	9.0	10.7D	4.65	8.6	2.0	3.0
13.3 / 10	54	13	20.25	13±	9.5	13.3D	5.78	8.4	2.0	3.38
16 / 12	66	16	25	16±	12	16D	6.96	10.0	3.0	4.13



Border and Legend: White
 Background: Green

*See Appendix B-1 for Standard Arrow Details.

Letter Size (inches)	A	B	C	D	E	F	G	H	J	K	L
6 / 4.5	36	6.0	9.56	6±	3.5	6D	2.0	13.0	2.6	1.0	1.5
8 / 6	54	8.0	12.75	8±	6.0	8D	6.0	20.0	3.48	1.25	2.25
10.7 / 8	72	11	17.25	11±	8.0	10.7D	8.0	26.7	4.65	2.0	3.0
13.3 / 10	90	13	20.25	13±	10	13.3D	10	33.3	5.78	3.0	3.38
16 / 12	108	16	25	16±	12	16D	12	40	6.96	3.0	4.13

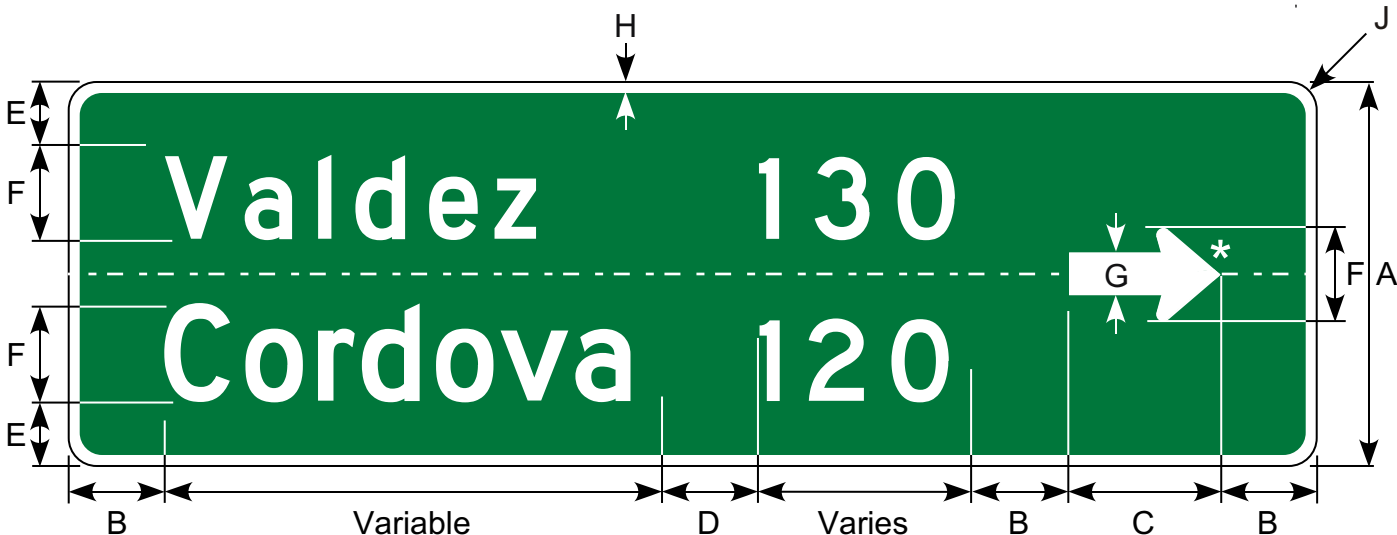

Border and Legend: White
 Background: Green

*See Appendix B-1 for Standard Arrow Details.

Letter Size (inches)	Dimensions (inches)								
	A	B	C	D	E	F	G	H	J
6 / 4.5	24	6.0	9.56	6±	4.0	6D	2.6	0.75	1.5
8 / 6	36	8.0	12.75	8±	7.0	8D	3.48	1.0	2.25
10.7 / 8	48	11	17.25	11±	9.0	10.7D	4.65	2.0	3.0
13.3 / 10	54	13	20.25	13±	9.5	13.3D	5.78	2.0	3.38
16 / 12	66	16	25	16±	12	16D	6.96	3.0	4.13

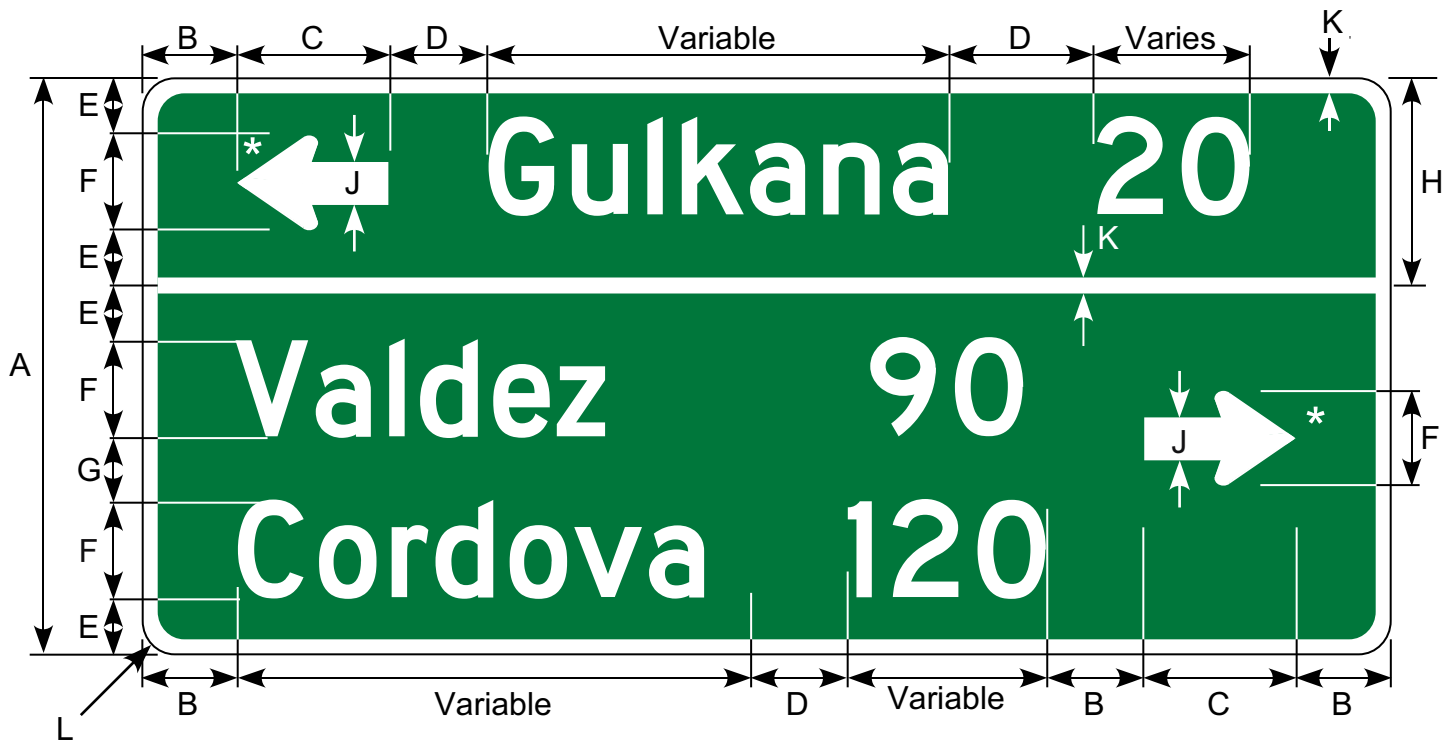

Border and Legend: White
Background: Green

*See Appendix B-1 for Standard Arrow Details.

Letter Size (inches)	Dimensions (inches)										
	A	B	C	D	E	F	G	H	J	K	L
6 / 4.5	36	6±	9.56	9	3.5	6D	4.0	13	2.6	1.0	2.25
8 / 6	54	8±	12.75	12	6.0	8D	6.0	20	3.48	1.25	3.38
10.7 / 8	72	11±	17.25	16	8.0	10.7D	8.0	26.7	4.7	2.0	4.0
13.3 / 10	90	13±	20.25	20	10	13.3D	10	33.3	5.8	3.0	4.0
16 / 12	108	16±	25	24	12	16D	12	40	7.0	3.0	4.0

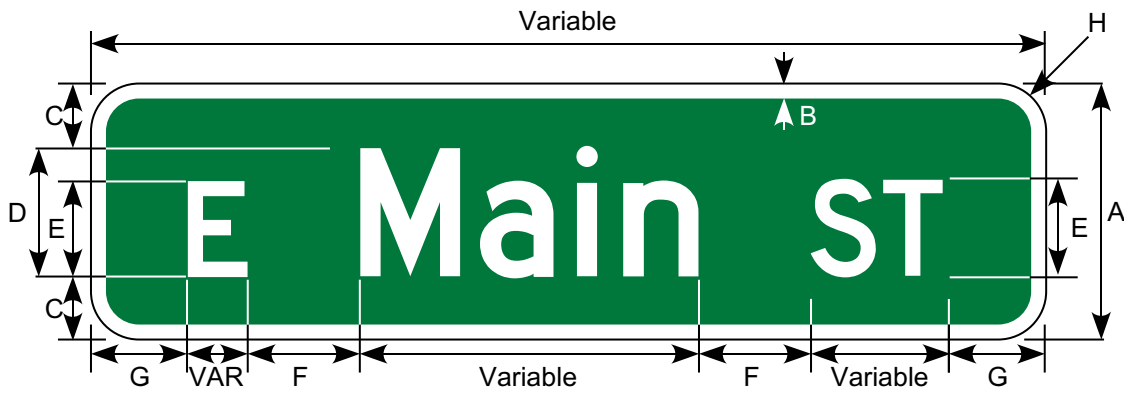

Border and Legend: White
Background: Green

* Letters may be series B, C, or D.

Road Class	Dimensions (inches)							
	A	B	C	D	E	F	G	H
Rds w Spd Limits <= 25MPH or Stop Condition	8	0.50	2.0	4*	3*	3.5	3±	1.5
All Other Roads	12	0.50	3.0	6*	4*	5.0	4±	1.5

D3-100A

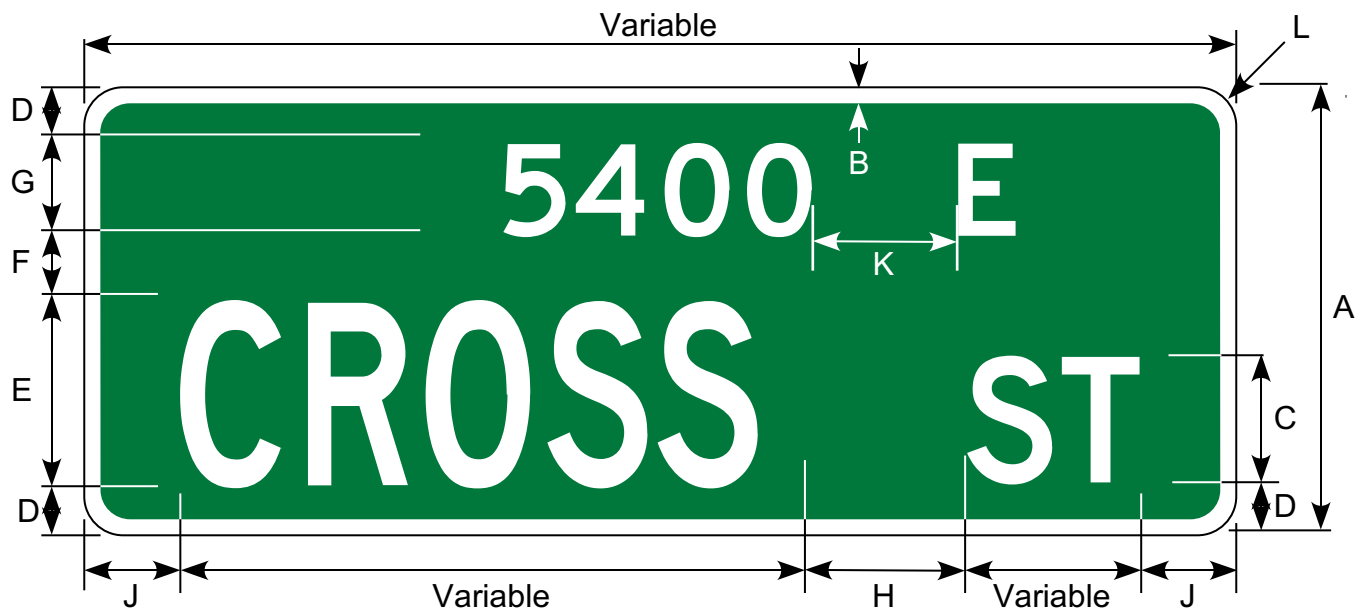

Border and Legend: White
Background: Green

* Letters may be series B, C, or D.

Letter Size (Inches)	A	B	C	D	E	F	G	H	J	K	L
6/4	14	0.5	4*	1.5	6*	2.0	3*	5.0	3±	4.5	1.5

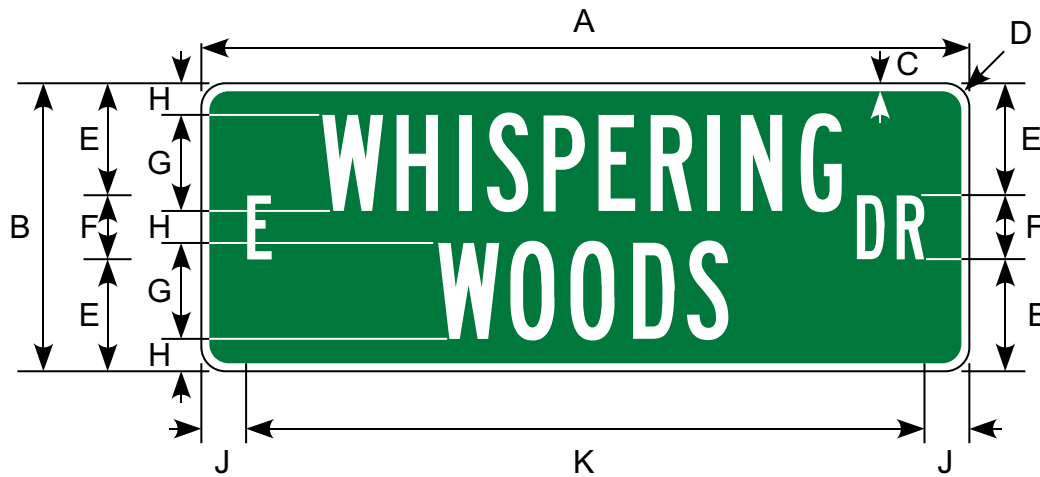

Border and Legend: White
Background: Green

* Letters may be series B, C, or D.

Letter Size (Inches)	Dimensions									
	A	B	C	D	E	F	G	H	J	K
Rds w/ Spd Limits <= 25 MPH or STOP Condition	Var	12.0	0.5	1.5	4.5	3B*	4B*	1.3	2.1	Var
All Other Roads	Var	18.0	0.5	1.5	7	4B*	6B*	2.0	2.8	Var

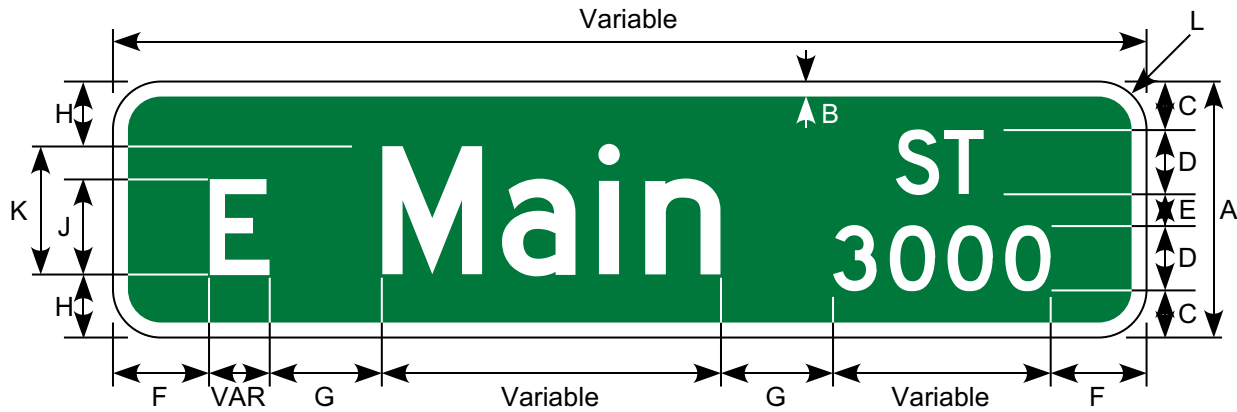

Border and Legend: White
Background: Green

* Letters may be series B, C, or D.
For Overhead Mounting Only

Road Class	Dimensions (inches)										
	A	B	C	D	E	F	G	H	J	K	L
Rds w Spd Limits <= 25MPH or Stop Condition	8	0.50	1.5	2*	1.0	3±	3.5	2.0	3*	4*	1.5
All Other Roads	12	0.50	2.0	3*	2.0	4.5±	5.0	3.0	4*	6*	1.5

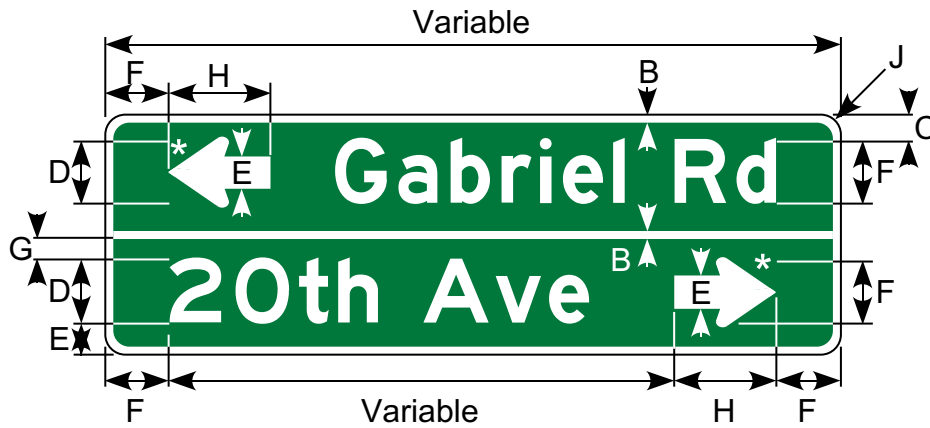

Border and Legend: White
Background: Green

For Overhead Mounting Only

* See Appendix B-1 for Standard Arrow Details.

Letter Size (inches)	Dimensions (inches)									
	A	B	C	D	E	F	G	H	J	
8 / 6	30	1.0	3.5	8E	4.0	8±	2.5	12.75	2.5	

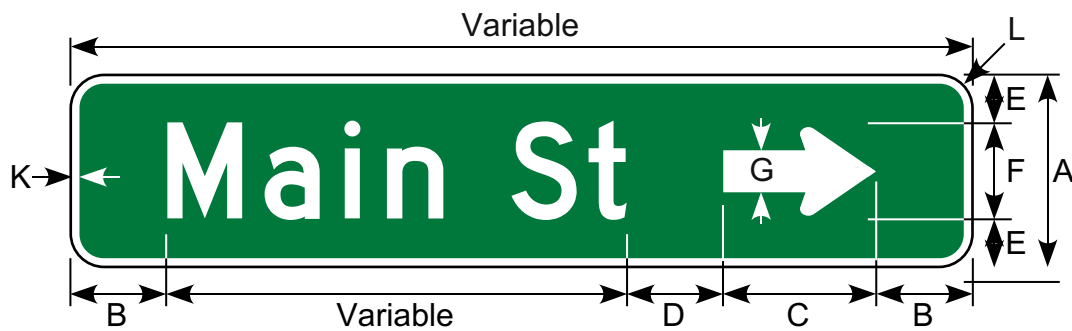

D3-2R

Border and Legend: White
Background: Green

*See Appendix B-1 for Standard Arrow Details.

*Arrow may be omitted



D3-200L

Letter Size (inches)	Dimensions (inches)								
	A	B	C	D	E	F	G	K	L
6 / 4.5	12	6±	9.56	6±	3.0	6D	2.6	0.63	1.5
8 / 6	24	8±	12.75	8±	8.0	8D	3.48	0.75	1.5
10.7 / 8	24	11±	17.25	11±	6.65	10.7D	4.65	1.25	1.88
13.3 / 10	36	13±	20.25	13±	11.35	13.3D	5.78	2.0	2.25
16 / 12	36	16±	25	16±	10	16D	6.96	2.0	2.63

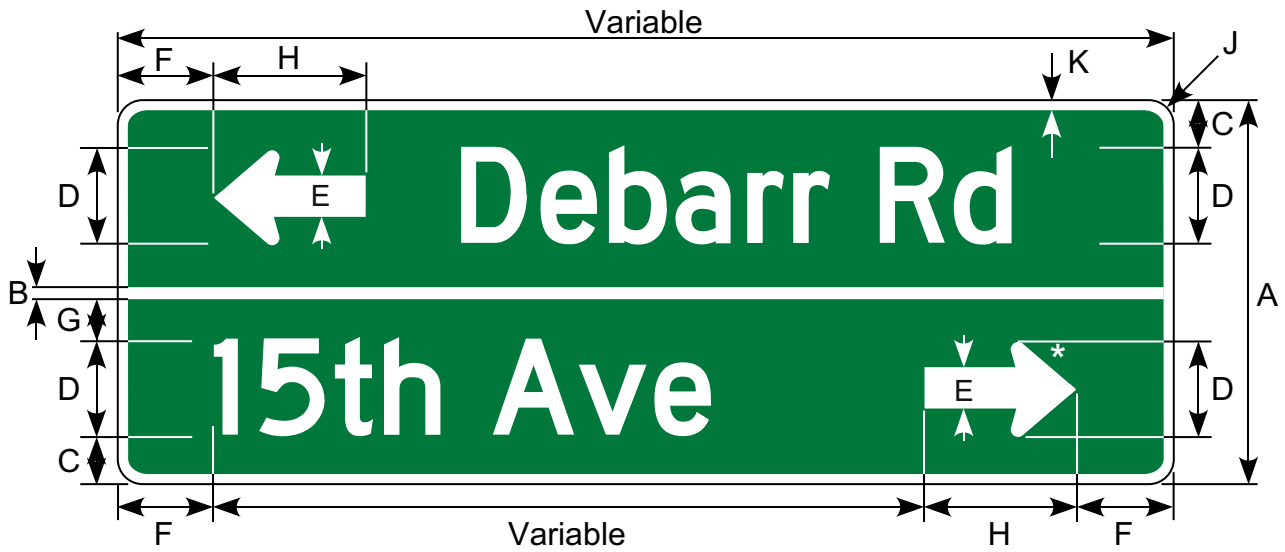

Border and Legend: White
Background: Green

*See Appendix B-1 for Arrow Details.

Letter Size (inches)	Dimensions (inches)									
	A	B	C	D	E	F	G	H	J	K
6 / 4.5	24	0.75	3.0	6D	2.6	6±	2.63	9.56	1.5	0.75
8 / 6	42	1.0	6.25	8D	3.48	8±	6.25	12.75	2.5	1.0
10.7 / 8	54	1.25	8.15	10.7D	4.65	11±	7.5	17.25	3.5	1.25
13.3 / 10	66	1.5	9.85	13.3D	5.78	13±	9.1	20.25	4.0	1.50



Border and Legend: White
Background: Brown

The legend may be constructed as a two-line or three-line sign. Subtract appropriate vertical dimension if designing a two-line sign.

If the directional arrow is omitted, the bottom line may be used for directional information, including: AHEAD, NEXT RIGHT, NEXT LEFT.

* Lettering may be series C or D.

** See Appendix B-1 for Standard Arrow Details.

Road Class	Dimensions (inches)						
	A	B	C	D	E	F	G
Min & Conv	VAR	42	0.63	6D*	6	1.5	2.3

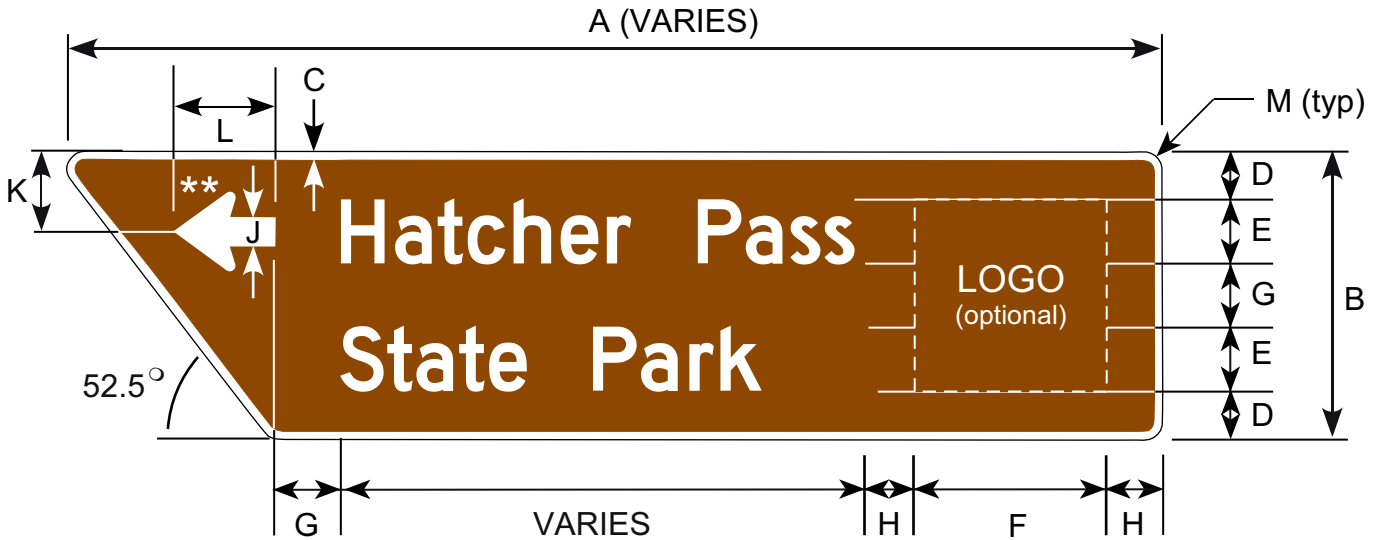

Angle the side of the sign the arrow is on.

Delete these dimensions if no logo.

Border and Legend: White
Background: Brown

* Lettering may be B, C, or D stroke width.

** See Appendix B-1 for Standard Arrow Details.

Arrow may be located on upper or lower line of legend.

Logos must conform to the the requirements of Chapter 2M of the Alaska Traffic Manual.

Road Class	Dimensions (inches)											
	A	B	C	D	E	F	G	H	J	K	L	M
Minimum	VAR	30	1	6	6D*	18	6	6	2.5	9.0	9.56	1.88
Conventional	VAR	36	1	6	8D*	24	8	7	3.0	10.0	12.75	2.25

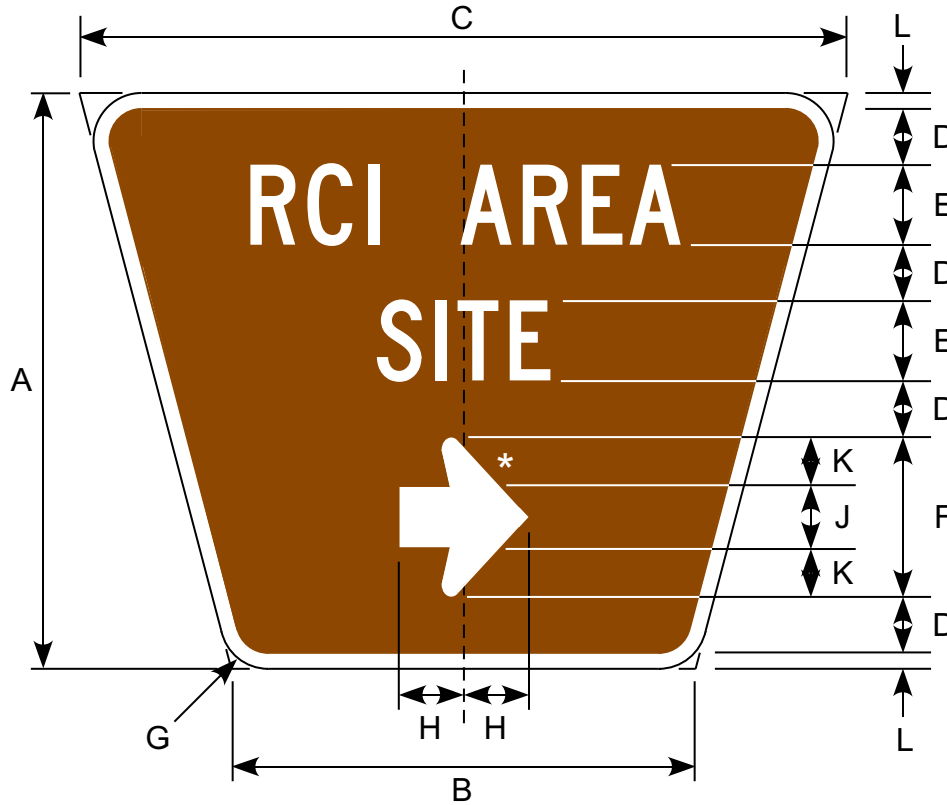

Any of the following legends may be used as alternates for line 3.

Code	Variable Legend
A	500 FT
B	1000 FT
C	1 MILE
D	1/2 MILE
E	1500 FT
F	AHEAD
G	NEXT RIGHT



Additional alternates for line 3.

Border and Legend: White
Background: Brown

* See Appendix B-1 for standard arrow details.

Road Class	Dimensions (inches)											
	A	B	C	D	E	F	G	H	J	K	L	N
Conventional	36	29	48	3.5	5C	10	3.0	4.06	4	3	1	4C
Expwy/Fwy	42	38	60	4.0	6C	12	3.5	6.38	6	3	1	5C



Border and Legend: White
Background: Green

Road Class	Dimensions (inches)						
	A	B	C	D	E	F	G
Conventional	72	36	1.0	6D	4.0	5.0	2.3
Expwy/Fwy	108	60	2.0	10D	7.0	8.0	3.8

D8-101

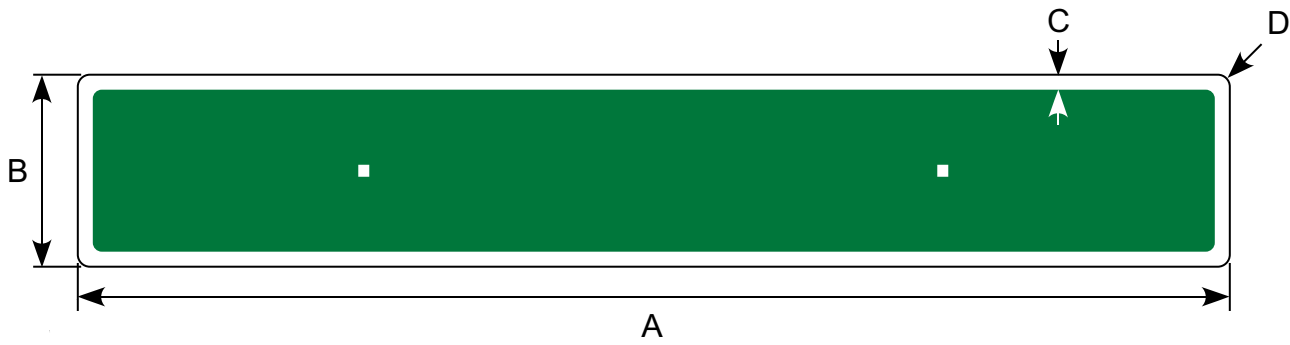

Road Class	Dimensions (inches)			
	A	B	C	D
Conventional	72	12	1.0	0.75
Expwy/Fwy	108	24	2.0	1.5

Front

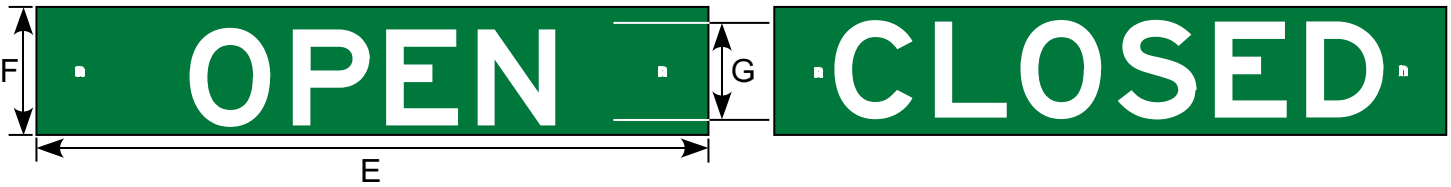

Border and Legend: White
Background: Green

Road Class	Dimensions (inches)		
	E	F	G
Conventional	42	8	6E
Expwy/Fwy	66	12	10E

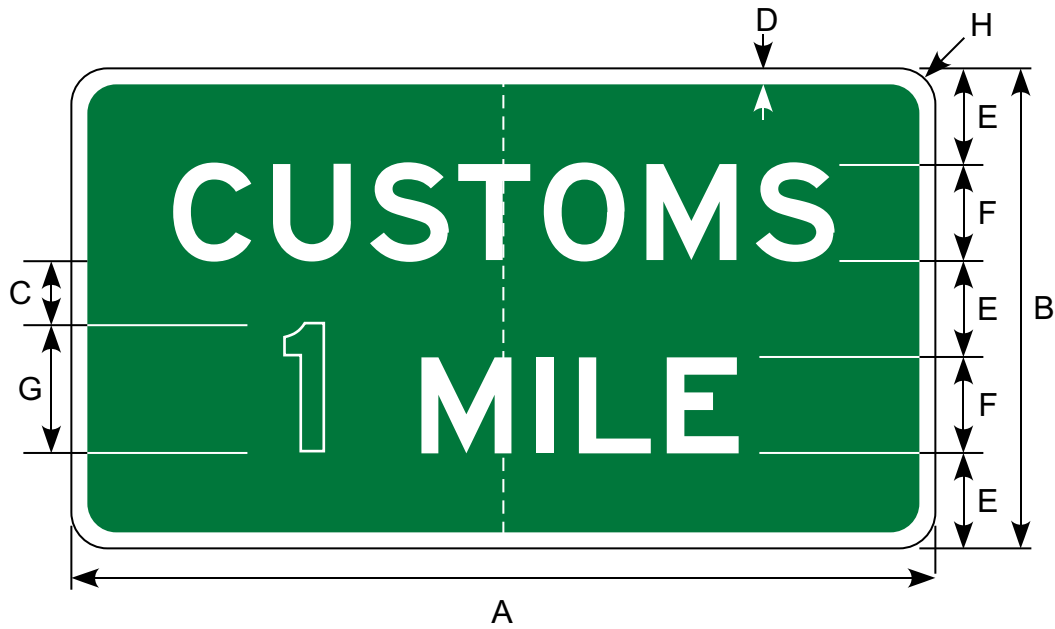

Border and Legend: White
 Background: Green

Road Class	Dimensions (inches)							
	A	B	C	D	E	F	G	H
Conv/Min	54	30	4	1	6	6E	8E	2.25
Expwy/Fwy	108	60	8	2	12	12E	16E	5.00

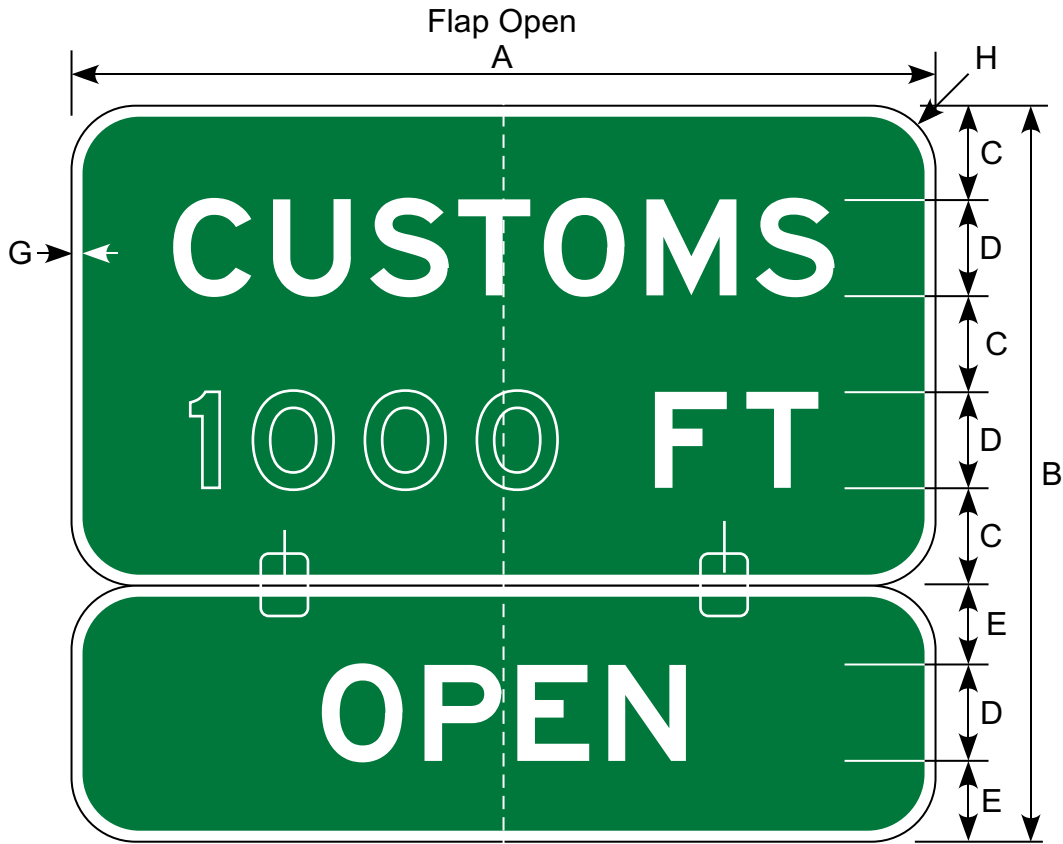

Flap Closed



Border and Legend: White
Background: Green

Road Class	Dimensions (inches)							
	A	B	C	D	E	F	G	H
Conv/Min	54	46	6.0	6E	5.0	30	0.75	5.0
Expwy/Fwy	72	60	8.0	8E	6.0	40	2.0	7.0

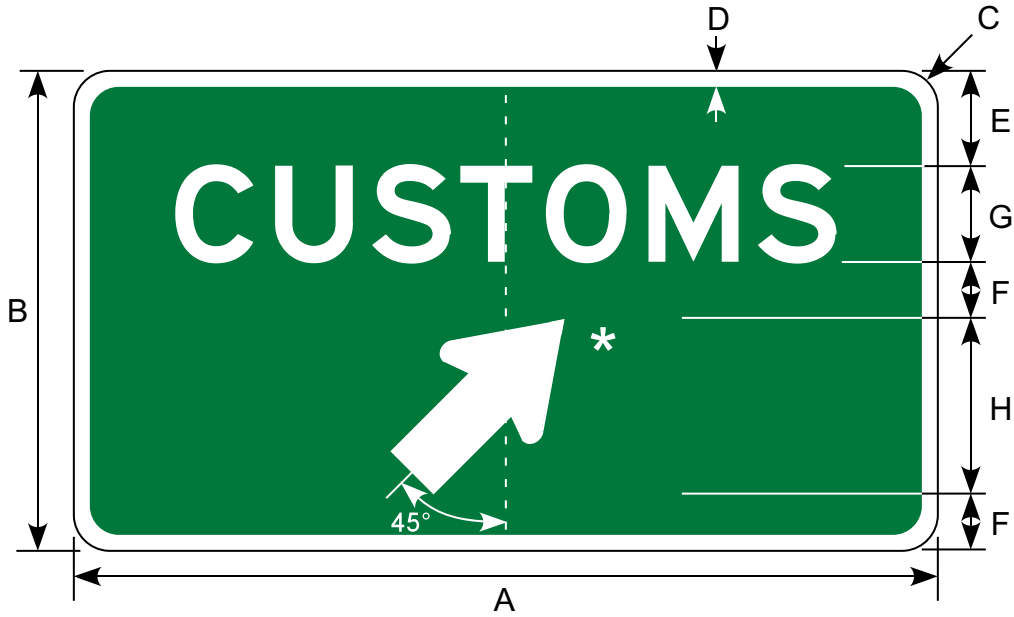

Border and Legend: White
Background: Green

*See Appendix B-4 for Arrow Details.

Road Class	Dimensions (inches)									
	A	B	C	D	E	F	G	H	J	K
Conv/Min	54	30	2.25	1.0	6.0	3.5	6E	11	20.75	20.81
Expwy/Fwy	108	60	3.75	2.0	12	10.0	12E	15	41.50	41.63

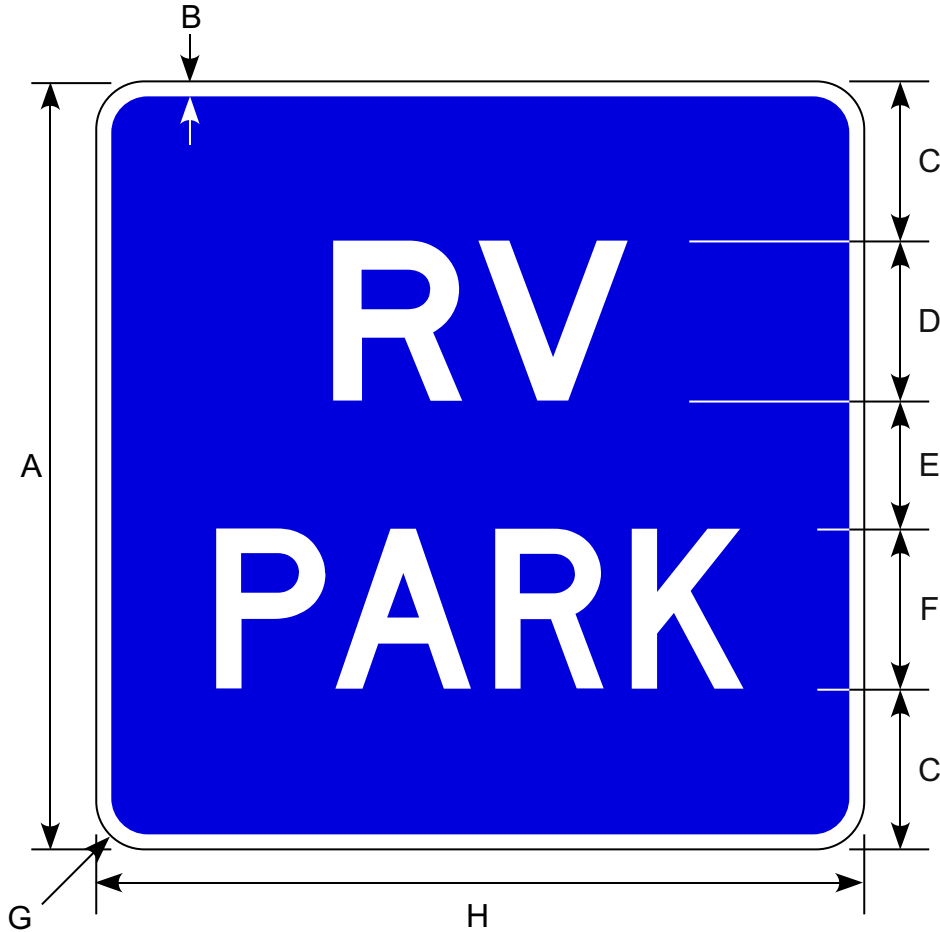

Border and Legend: White
Background: Blue

Road Class	Dimensions (inches)							
	A	B	C	D	E	F	G	H
For Use on D9-204, D9-206	17.5	0.5	3.25	4E	2.75	3.75D	1.13	17.75
Conv/Min	24	0.50	5.0	5E	4	5D	1.5	24
Expressway	30	0.75	6.5	7E	3	7D	1.88	30

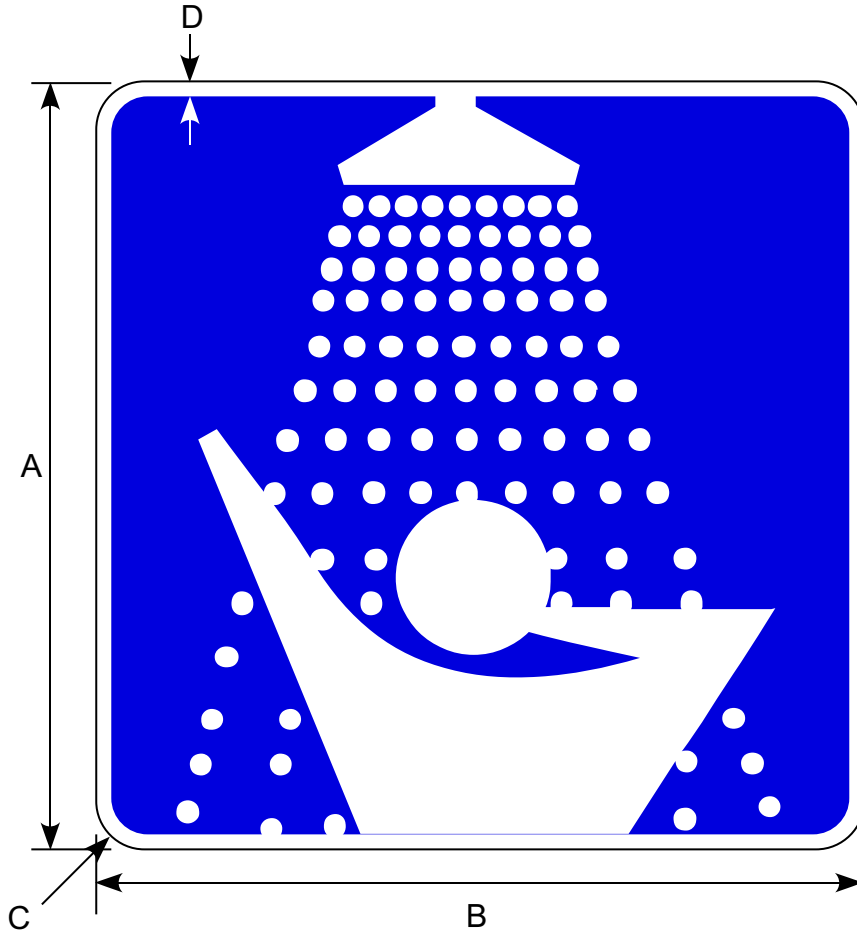

Border and Legend: White
Background: Blue

Road Class	Dimensions (inches)			
	A	B	C	D
For Use on D9-204, D9-206	17.5	17.75	1.13	0.5
Conv/Min	24	24	1.5	0.5
Expressway	30	30	1.88	0.75

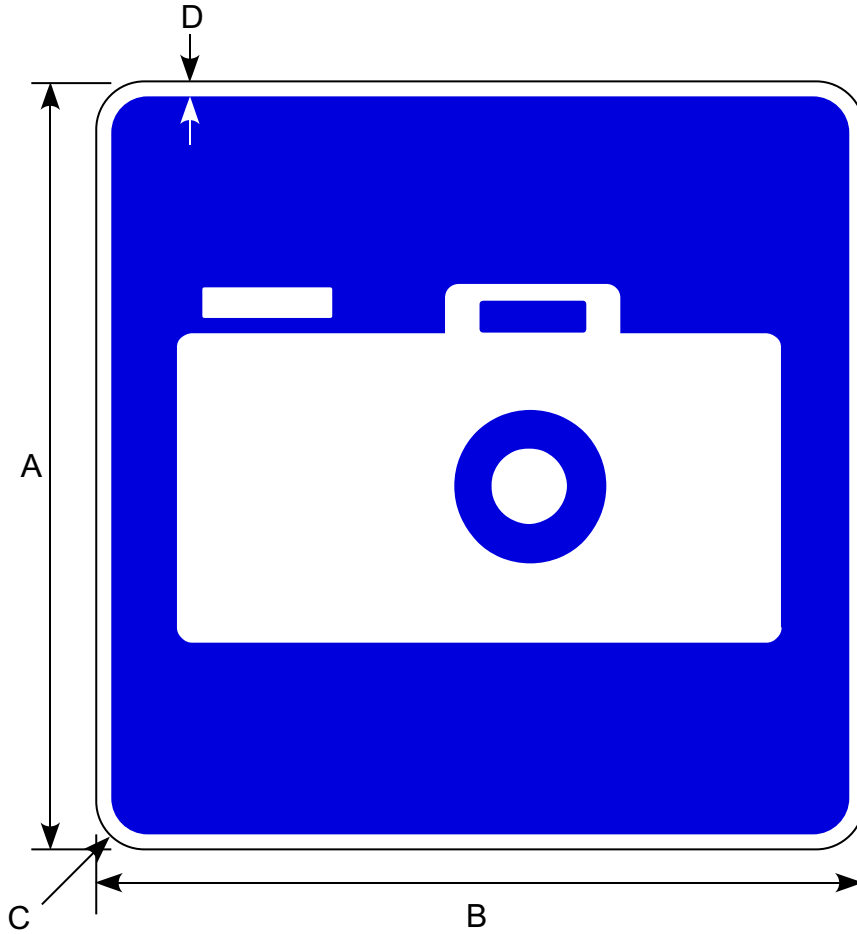

Border and Legend: White
Background: Blue

Road Class	Dimensions (inches)			
	A	B	C	D
For Use on D9-204, D9-206	17.5	17.75	1.13	0.5
Conv/Min	24	24	1.5	0.5
Expressway	30	30	1.88	0.75

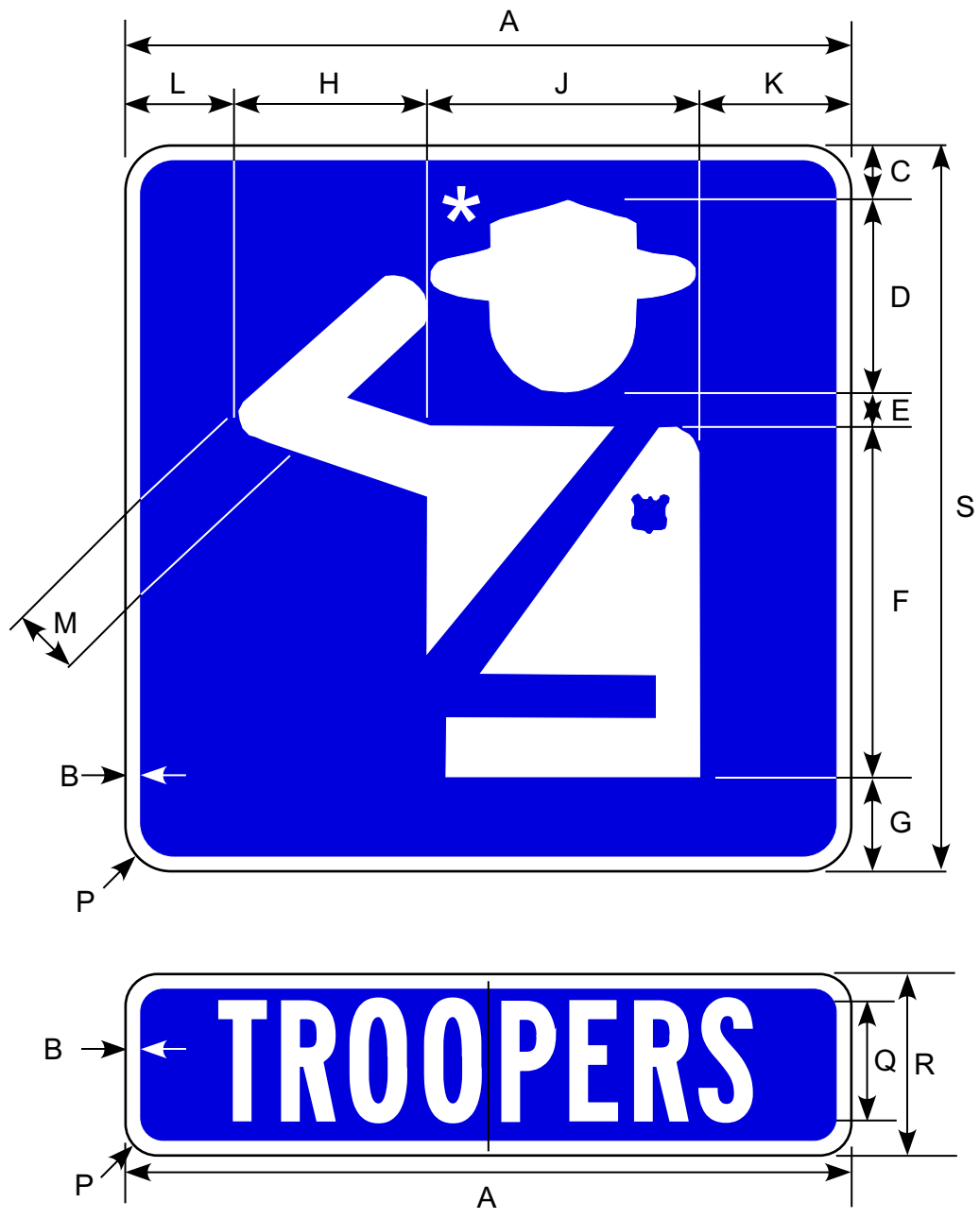

Border and Legend: White
Background: Blue

* Make symbol proportional to graphic shown.

Educational plaque optional.

Road Class	Dimensions (inches)															
	A	B	C	D	E	F	G	H	J	K	L	M	P	Q	R	S
For Use on D9-204, D9-206	17.75	0.5	1.38	4.8	0.8	8.72	1.8	4.79	6.75	3.5	2.72	1.69	1.13	3B	4.5	17.5
Conv/Min	24	0.50	1.81	6.44	1.06	11.63	3.06	6.38	9.0	5.0	3.63	2.25	1.5	4B	6.0	24.0
Oversized	30	0.75	2.25	8.0	1.38	14.5	3.88	8.0	11.25	6.75	4.0	2.75	1.88	4C	6.0	30.0

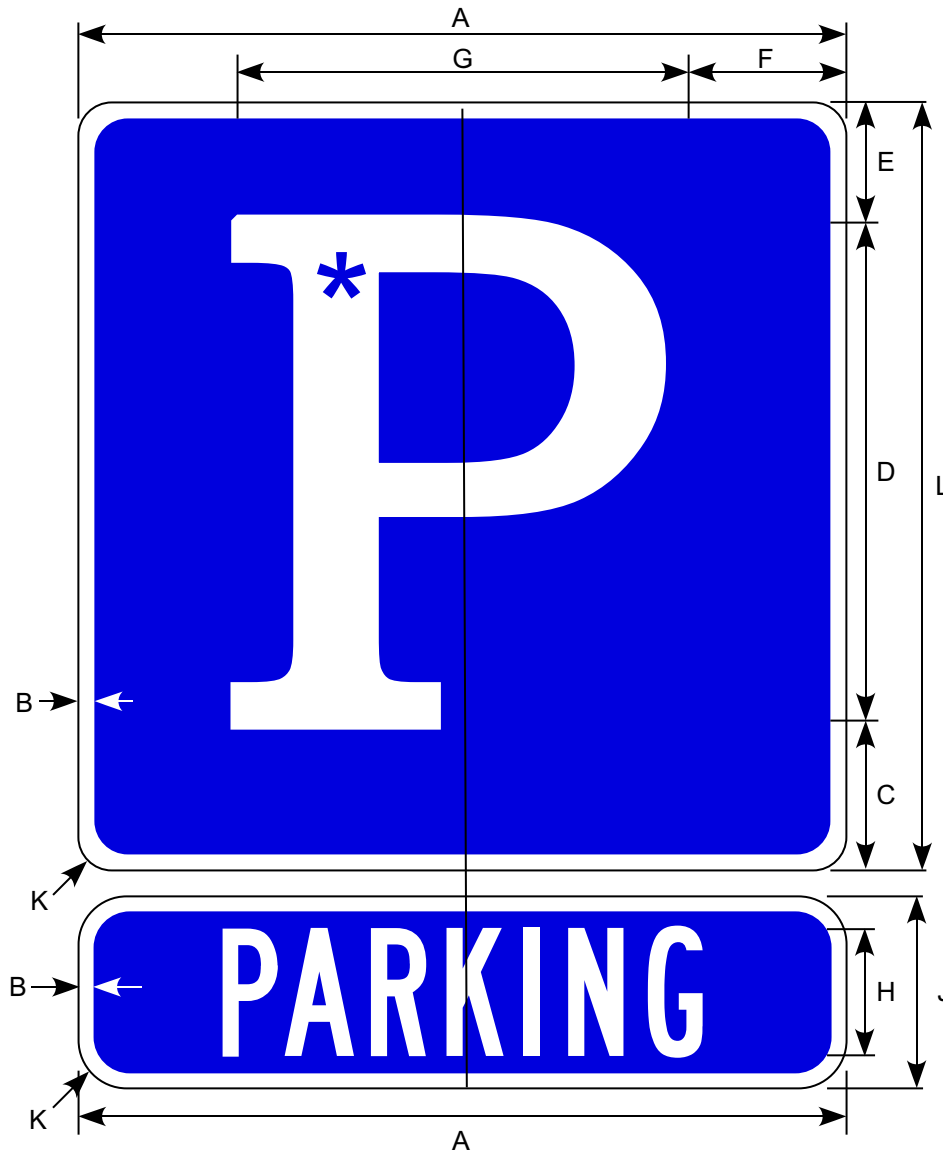

Border and Legend: White
Background: Blue

* Make symbol proportional to graphic shown

Educational plaque optional.

Road Class	Dimensions (inches)										
	A	B	C	D	E	F	G	H	J	K	L
For Use on D9-204, D9-206	17.75	0.5	2.97	11.67	2.86	3.5	10.6	3B	4.5	1.13	17.5
Conv/Min	24	0.50	4.63	15.56	3.81	4.94	14.13	4B	6.0	1.5	24
Oversized	30	0.75	5.81	19.44	4.75	6.0	18	4C	6.0	1.88	30

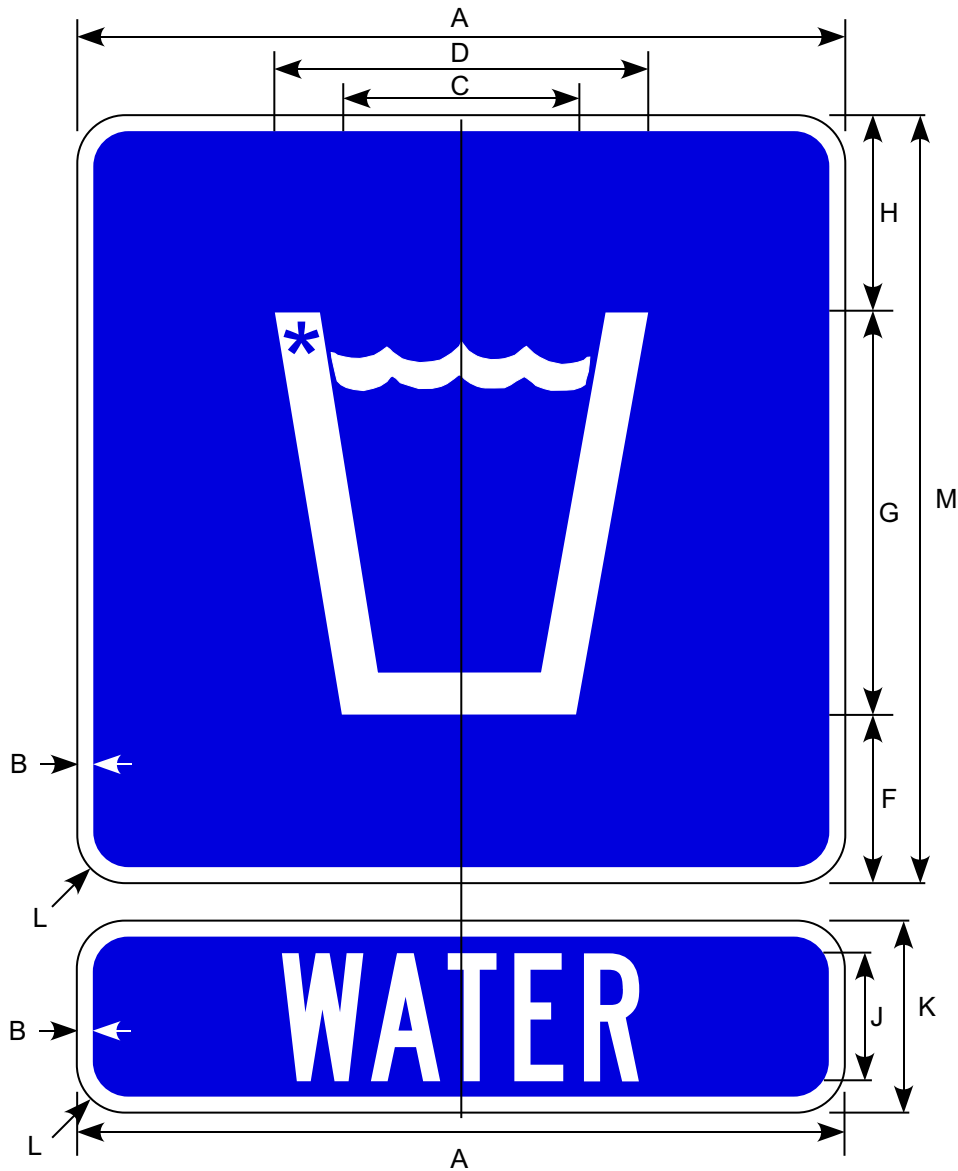

Border and Legend: White
Background: Blue

* Make symbol proportional to graphic shown.

Educational plaque optional.

Class	A	B	C	D	F	G	H	J	K	L	M
For Use on D9-204, D9-206	17.75	0.5	5.54	8.77	3.94	9.47	4.09	3B	4.5	1.13	17.5
Conv/Min	24	0.50	7.38	11.69	5.25	12.63	6.12	4B	6.0	1.5	24
Oversized	30	0.75	9.25	14.63	6.56	15.75	7.69	4C	6.0	1.88	30

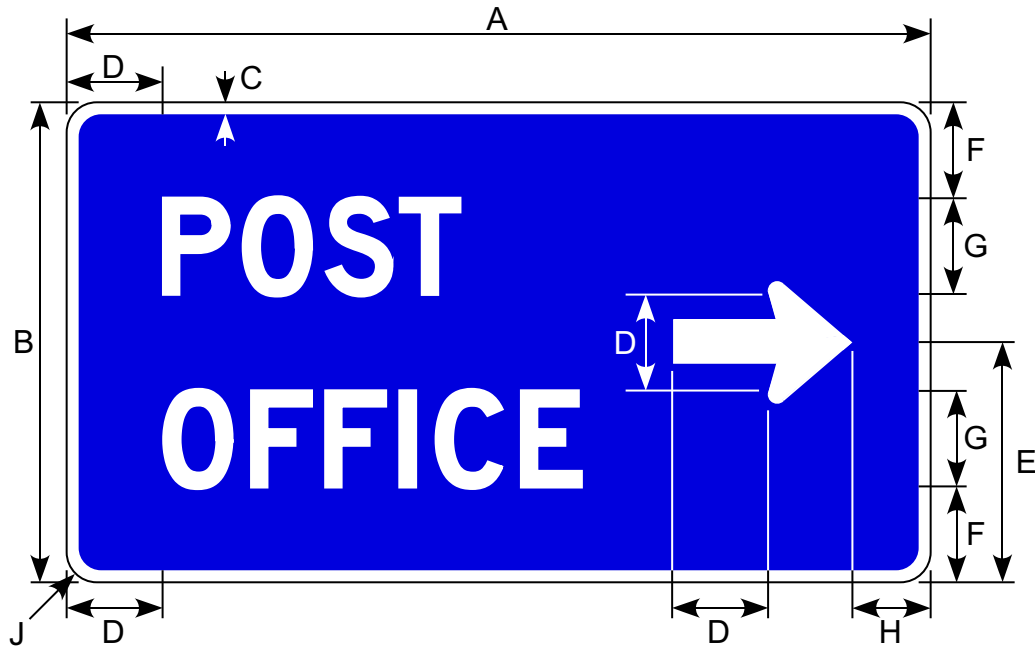

Border and Legend: White
 Background: Blue

See Appendix B-1 for Standard Arrow Details.

Road Class	Dimensions (inches)								
	A	B	C	D	E	F	G	H	J
Minimum	36	24	0.63	4.0	12	6.0	4D	2.75	1.5
Conventional	54	30	0.75	6.0	15	6.0	6D	4.88	1.88
Expressway	72	36	0.88	8.0	18	6.0	8D	6.88	2.25
Oversized	90	48	1.25	10	24	9.0	10D	8.88	3.0

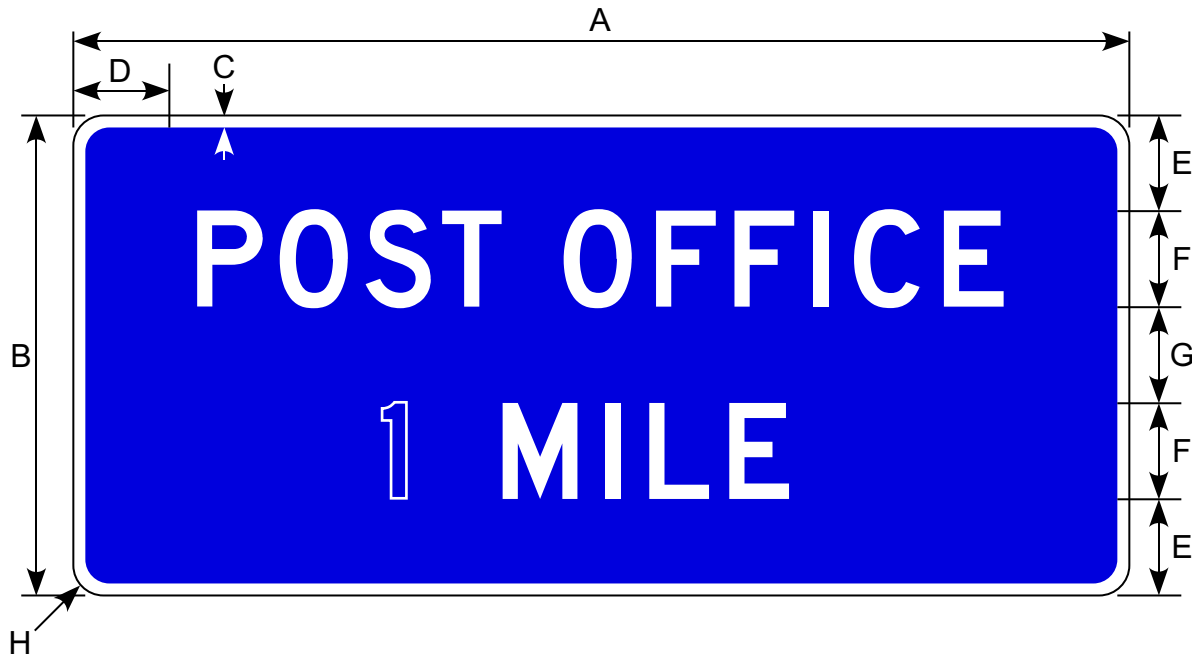

Border and Legend: White
 Background: Blue

Road Class	Dimensions (inches)							
	A	B	C	D	E	F	G	H
Minimum	48	24	0.63	5.75	6.0	4D	4.0	1.5
Conventional	66	30	0.75	6.0	6.0	6D	6.0	1.88
Expressway	90	36	0.88	8.5	6.0	8D	8.0	2.25
Oversized	114	48	1.25	11.5	9.0	10D	10	3.0



Border and Legend: White
Background: Blue

Road Class	Dimensions (inches)							
	A	B	C	D	E	F	G	H
For Use on D9-204, D9-206	17.5	0.5	3	4E	4	4C	1.13	17.75
Conv/Min	24	0.50	4.5	5E	5	5C	1.5	24
Expressway	30	0.75	4.5	7E	7	6C	1.88	30



Border and Legend: White
Background: Blue

* See Appendix B-1 for Standard Arrow Details.

** Symbol and arrow reversible. Make symbol proportional to graphic shown.

Road Class	Dimensions (inches)												
	A	B	C	D	E	F	G	H	J	K	L	M	N
Conv & Min	30	36	0.63	2.0	26	2.5	10.5	2.63	1.5	5D	2.5	4C	1.5

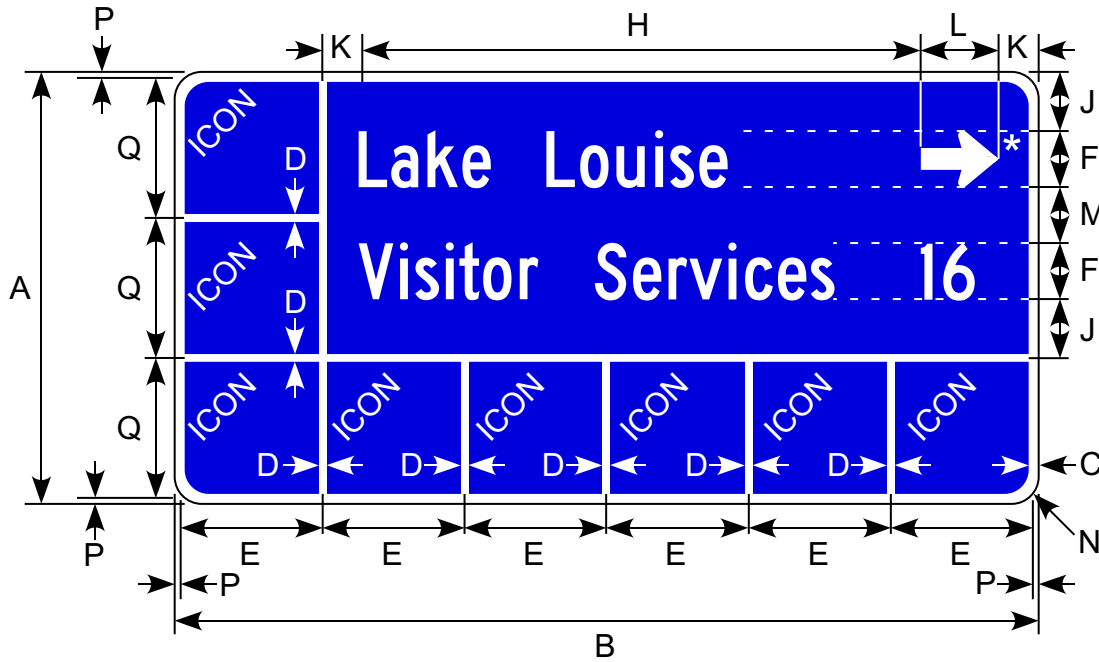

Border and Legend: White
 Background: Blue

* Arrow should always be placed near the outer edge of the sign, icons should be placed on other side of sign. See Appendix B-1 for Standard Arrow Details.

NOTE: The P-dimension illustrates that the border of the inserted icon does not fully cover the border of the sign.

Reverse sign layout for left or up arrow.

Road Class	Dimensions (inches)														
	A	B	C	D	E	F	G	H	J	K	L	M	N	P	Q
Conv & Min	54	108	1.25	1	17.75	7C	2.0	VAR	7.38	5	9.75	7.00	3.38	0.75	17.50

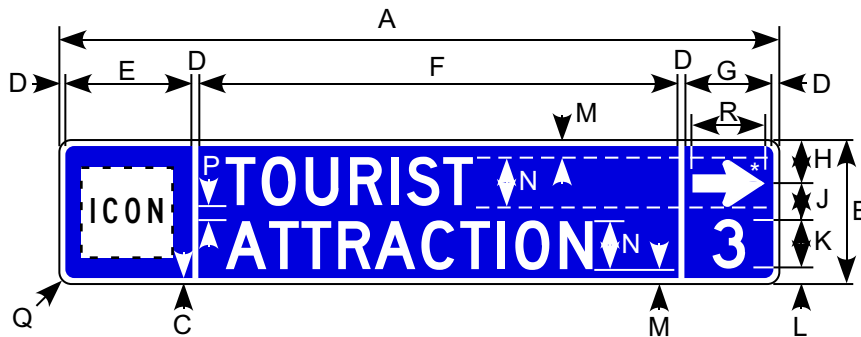

Border and Legend: White
Background: Blue

*See Appendix B-1 for Standard Arrow Details.

NOTES:

This is a Tourist-Oriented Directional Sign (TODS).

- 1) The length of legend on any one line shall not exceed 54 inches.
- 2) Up to three TODS panels may be placed (with a two inch vertical separation) on one set of sign supports.
- 3) When arrows on multiple panels point in different directions, the panels shall be arranged as follows starting from the top:
Arrow Up, Arrow Left, Arrow Right.
- 4) When arrows on multiple panels point in the same direction, the top panel shall show the nearest business and the bottom panel shall show the most distant.
- 5) * 6" series C letters may be used when the legend will not fit with series D.
- 6) If attraction is adjacent to roadway, delete mileage and center arrow in space.

Road Class	Dimensions (inches)																
	A	B	C	D	E	F	G	H	J	K	L	M	N	P	Q	R	
Conv & Min	90	18	0.75	0.75	16	60	11	5.38	4.63	6D*	2	2	6D	2	1.5	9	

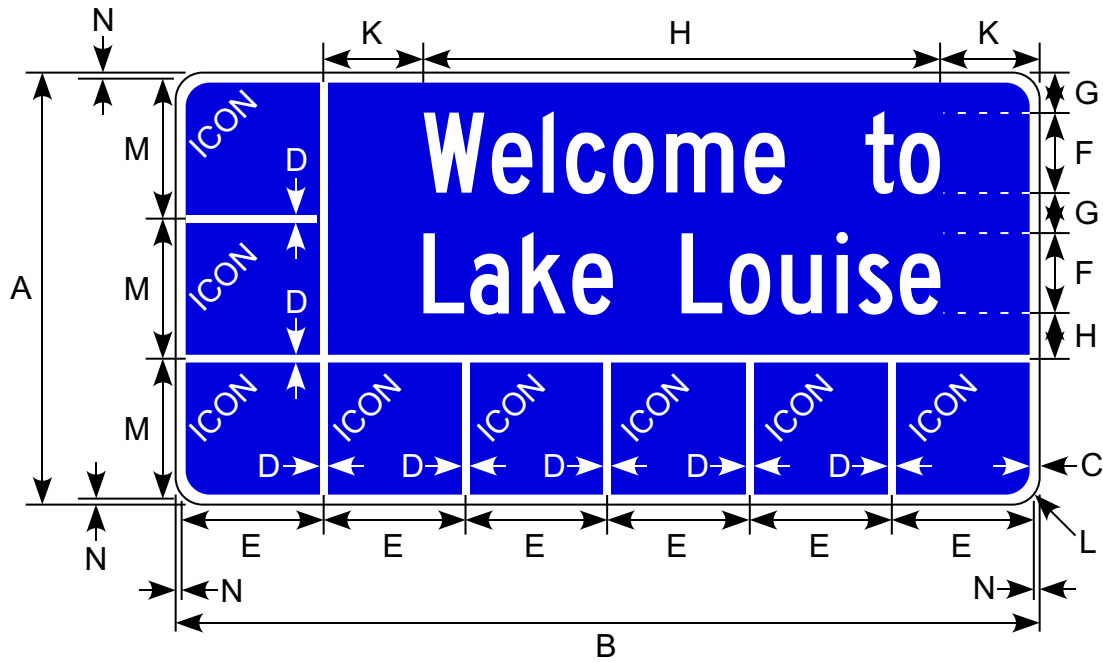

Border and Legend: White
Background: Blue

NOTE: The N-dimension illustrates that the border of the inserted icon does not fully cover the border of the sign.

Road Class	Dimensions (inches)													
	A	B	C	D	E	F	G	H	J	K	L	M	N	
Conv &	54	108	1.25	1	17.75	10C	5	5.75	VAR	VAR	3.38	17.50	0.75	

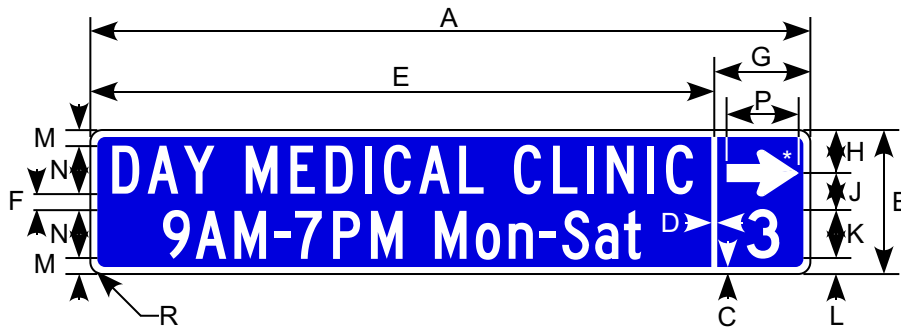

Border and Legend: White
 Background: Blue

*See Appendix B-1 for Standard Arrow Details.

Road Class	Dimensions (inches)														
	A	B	C	D	E	F	G	H	J	K	L	M	N	P	R
Conv & Min	90	18	0.75	0.75	78	2	12	5.37	4.63	6D	2	2	6C	9	1.5

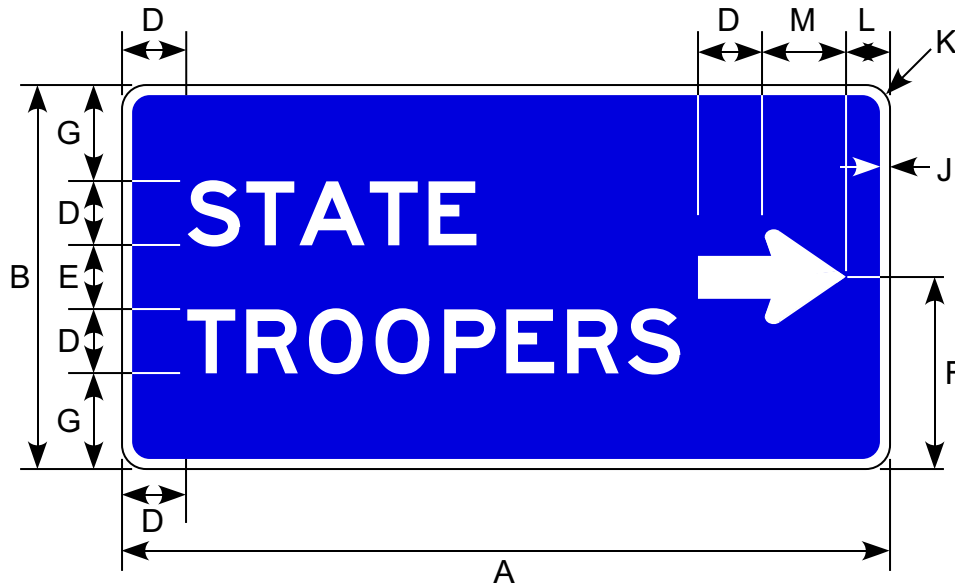

Border and Legend: White
 Background: Blue

*See Appendix B-1 for Standard Arrow Details.

Road Class	Dimensions (inches)									
	A	B	D	E	F	G	J	K	L	M
Minimum	48	24	4E	4.0	12	6.0	0.63	1.5	2.75	5.25
Conventional	66	30	6E	6.0	15	6.0	0.75	1.88	4.88	7.13
Expressway	90	36	8E	8.0	18	6.0	0.88	2.25	6.88	9.13
Freeway	114	48	10E	10	24	9.0	1.25	3.0	8.88	11.13

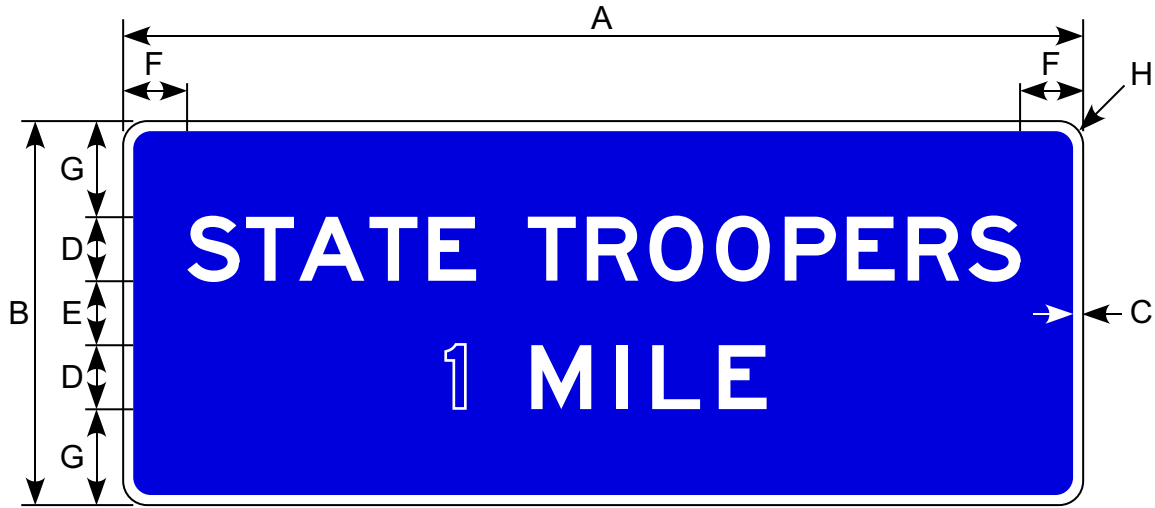

Border and Legend: White
 Background: Blue

Road Class	Dimensions (inches)							
	A	B	C	D	E	F	G	H
Minimum	60	24	0.63	4E	4.0	4.0	6.0	1.5
Conventional	84	30	0.75	6E	6.0	6.0	6.0	1.88
Expressway	114	36	0.88	8E	8.0	8.75	6.0	2.25
Freeway	144	48	1.25	10E	10	11.75	9.0	3.0

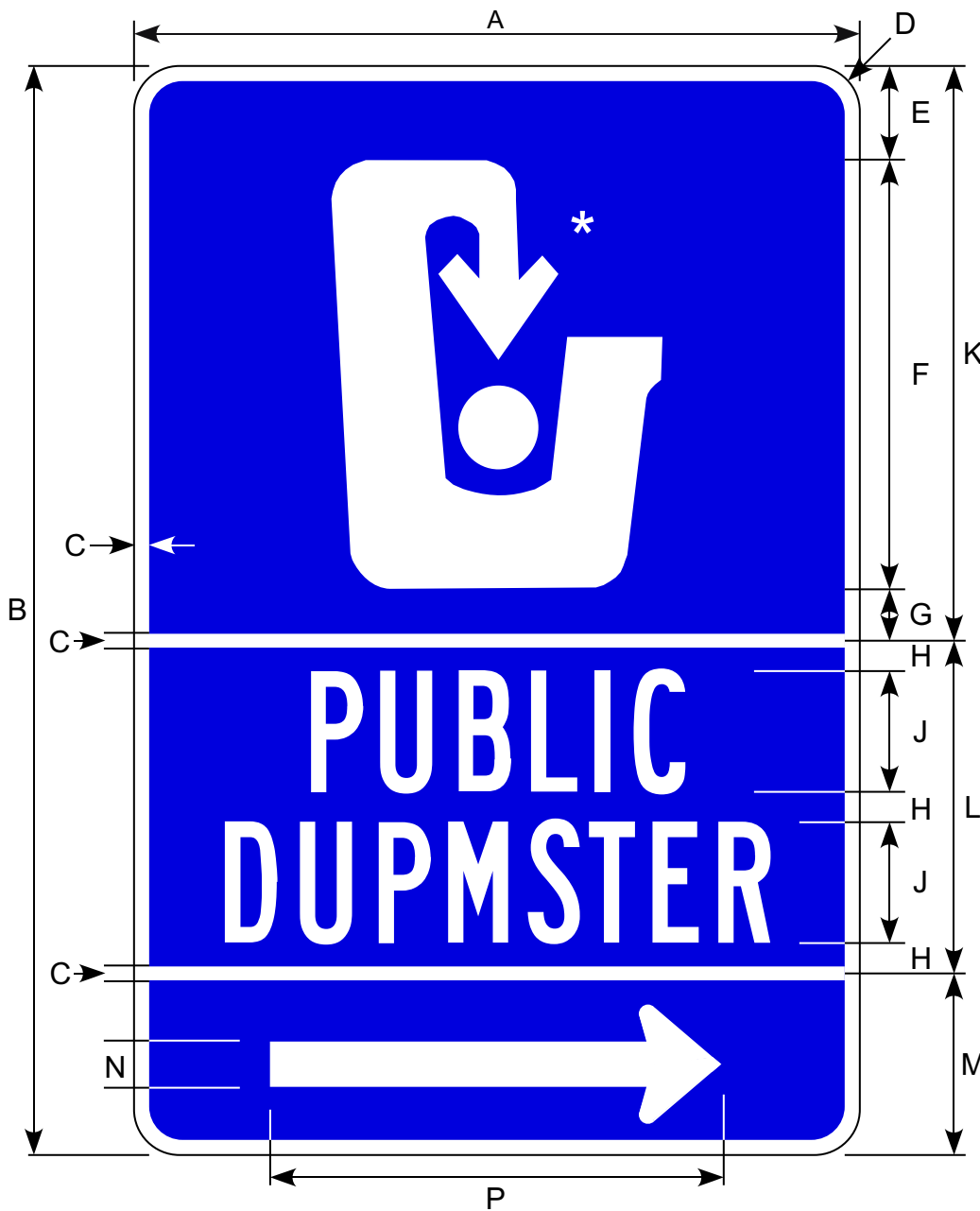

Alternative Legends:

SANITARY
LANDFILL

TRANSFER
SITE

Border and Legend: White
Background: Blue
Circle in Dumpster: White

* Make symbol proportional
to graphic shown.

** See Appendix B-1 for Standard Arrow Details.

Road Class	Dimensions (inches)														
	A	B	C	D	E	F	G	H	J	K	L	M	N	P	
Conv & Min	24	36	0.5	1.5	3.1	14.2	1.7	1	4B	19	11	6	1.5	15	

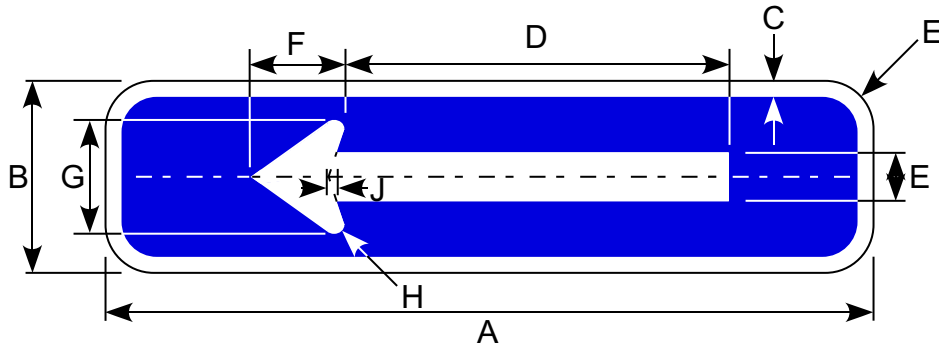

* See Appendix B-1 for Standard Arrow Details.

Border and Legend: White
 Background: Blue or Brown or Green

Road Class	Dimensions (inches)								
	A	B	C	D	E	F	G	H	J
Conventional	24	6.0	0.5	12	1.5	3.0	3.5	0.25	0.37

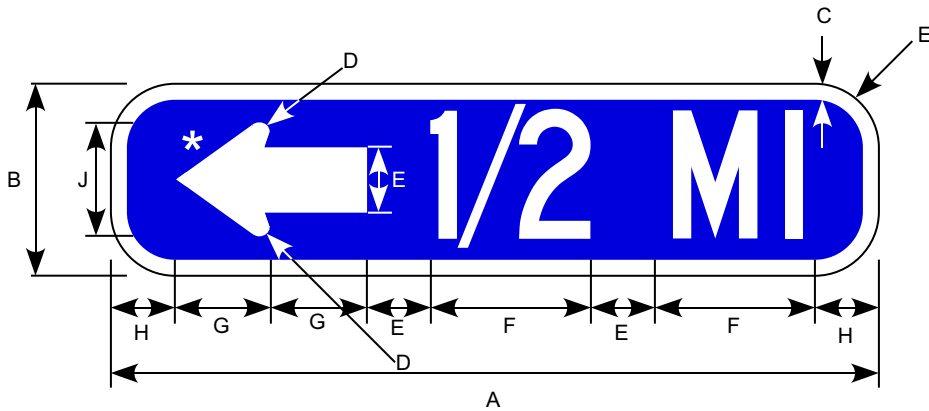

Border and Legend: White
Background: Blue or Brown

Note: Use 4" Series C for cap, 4" Series C numerals or 3" Series C fraction (shown).

* See Appendix B-1 for Standard Arrow Details.

Road Class	Dimensions (inches)								
	A	B	C	D	E	F	G	H	J
Conventional	24	6.0	0.5	0.25	2±	5.0	3.0	2.0	3.5

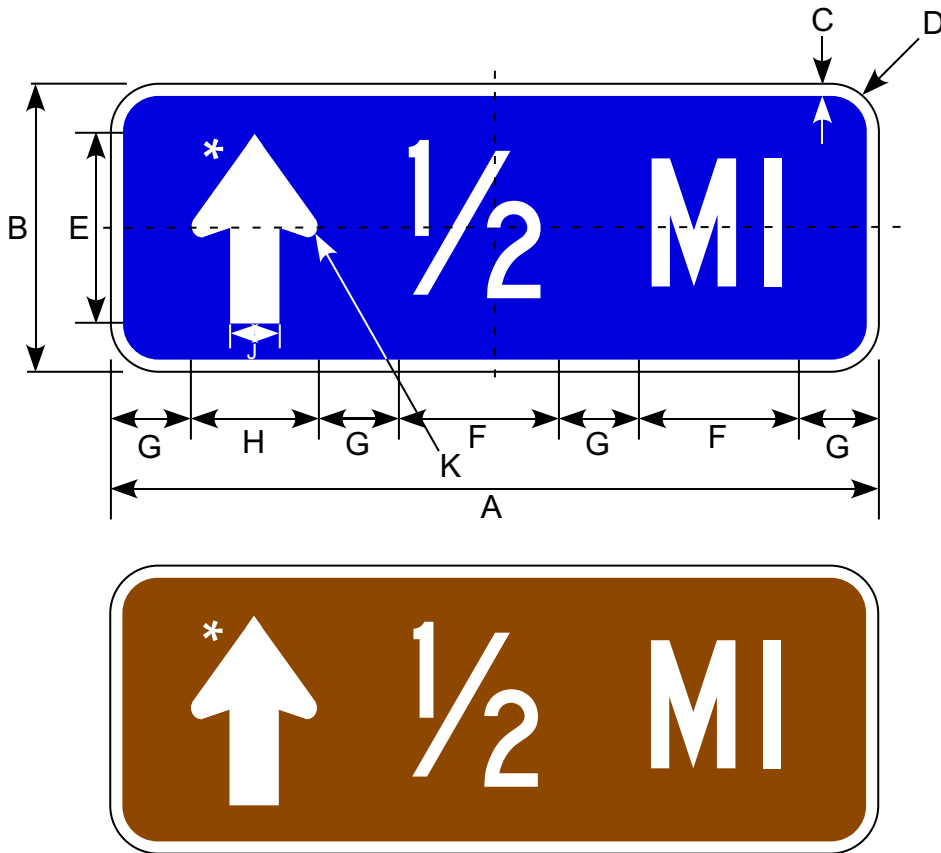

Border and Legend: White
Background: Blue or Brown

Note: Use 4" Series C for cap, 4" Series C numerals or 3" Series C fraction (shown).

* See Appendix B-1 for Standard Arrow Details.

Road Class	Dimensions (inches)									
	A	B	C	D	E	F	G	H	J	K
Conventional	24	9.0	0.38	1.50	6	5.0	2.5	4.0	1.5	0.25

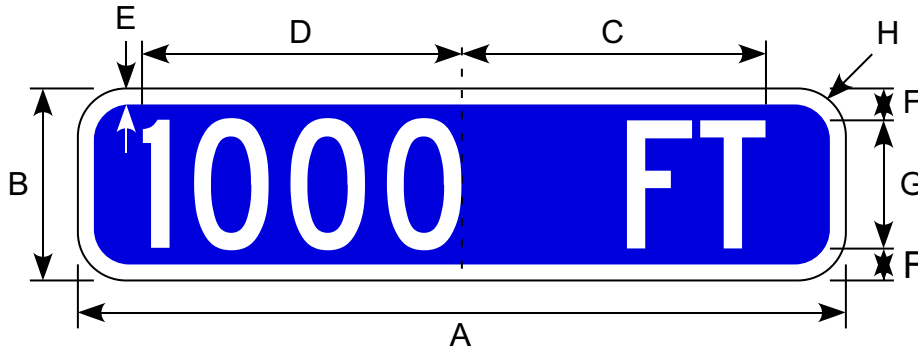

D9-304BL

Border and Legend: White
 Background: Blue or Brown

Road Class	Dimensions (inches)							
	A	B	C	D	E	F	G	H
Conv & Min	24	6	9.5	10	0.5	1	4C	1.5

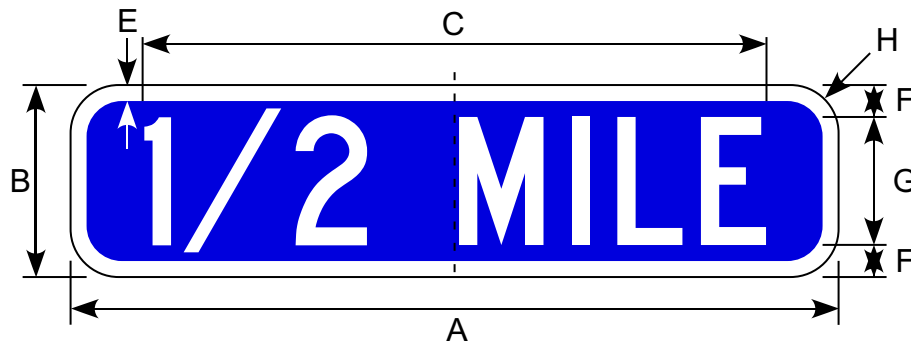

D9-305BL

Border and Legend: White
 Background: Blue or Brown

Road Class	Dimensions (inches)						
	A	B	C	E	F	G	H
Conv & Min	24	6	19.50	0.5	1	4C	1.5

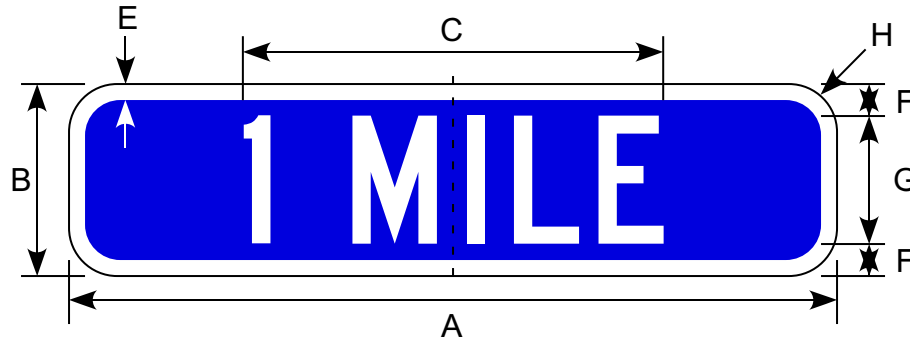

Border and Legend: White
 Background: Blue or Brown

Road Class	Dimensions (inches)						
	A	B	C	E	F	G	H
Conv & min	24	6.00	13.13	0.50	1.00	4C	1.50

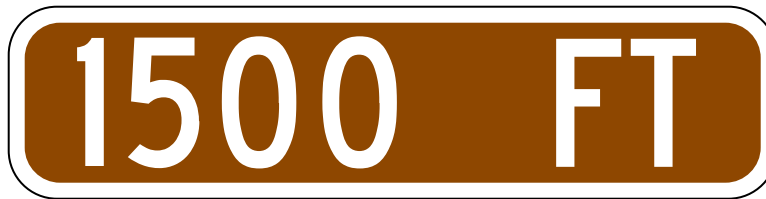
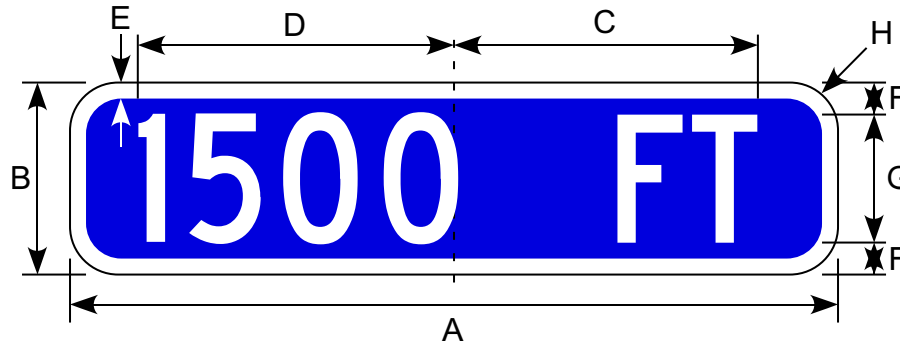

Border and Legend: White
 Background: Blue or Brown

Road Class	Dimensions (inches)							
	A	B	C	D	E	F	G	H
Conv & Min	24	6	9.50	9.88	0.5	1	4C	1.5

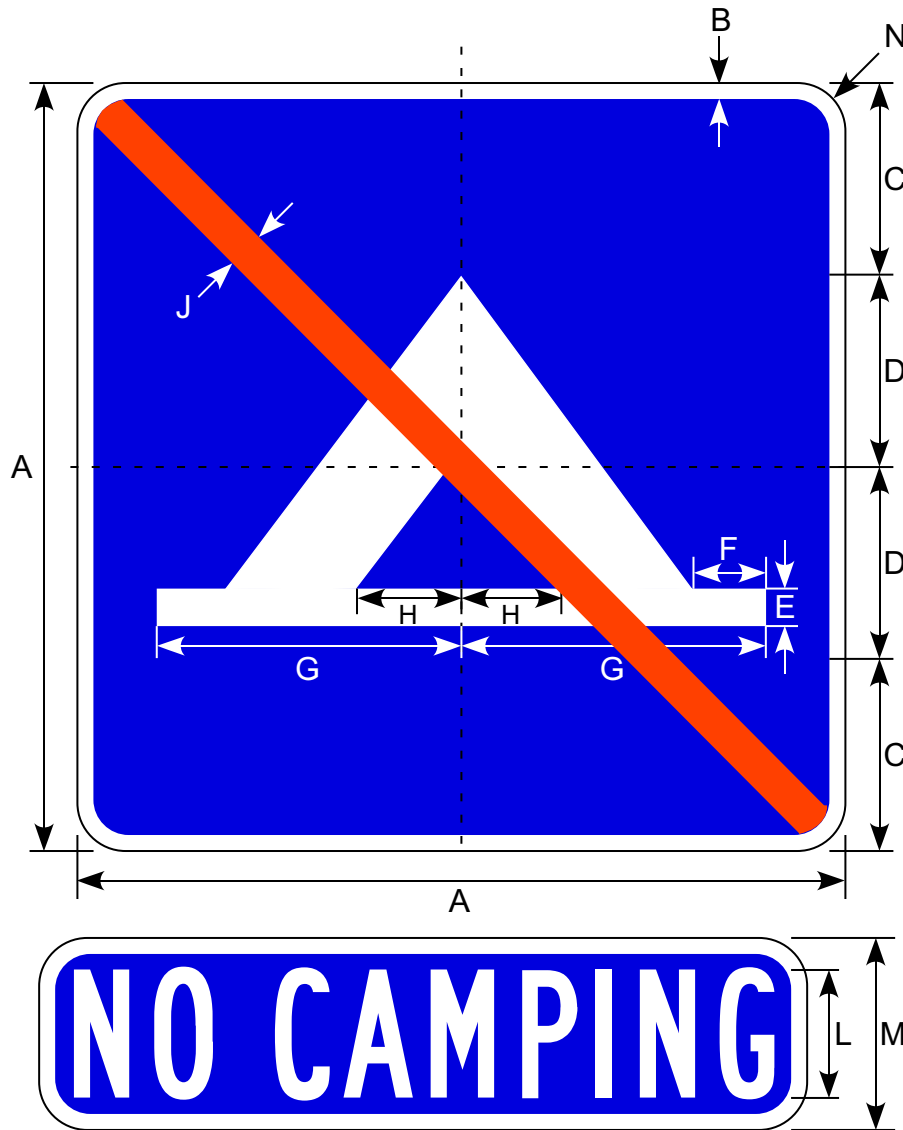

Border and Legend: White
 Background: Blue
 Cross Stripe: Red

Make symbol proportional to graphic shown
 Educational plaque optional.

Road Class	Dimensions (inches)											
	A	B	C	D	E	F	G	H	J	L	M	N
Conv/Min	24	0.50	6.0	6.0	1.13	2.25	9.50	3.25	1.25	4B	6	1.50
Expressway	30	0.75	7.5	7.5	1.44	2.81	11.88	4.06	1.75	4B	6	1.88



Border and Legend: White
 Background: Blue
 Cross Stripe: Red

* Make symbol proportional to graphic shown.

Educational plaque optional.

Road Class	Dimensions (inches)											
	A	B	C	D	E	F	G	H	K	L	M	N
Conv/Min	24	0.50	7.45	4.55	6.70	5.30	8.80	8.75	1.25	4B	6	1.50
Expressway	30	0.75	9.31	5.69	8.38	6.63	11.00	10.93	1.75	4B	6	1.88

Message on one
side of sign

D10-101
D10-102
D10-103
D10-104

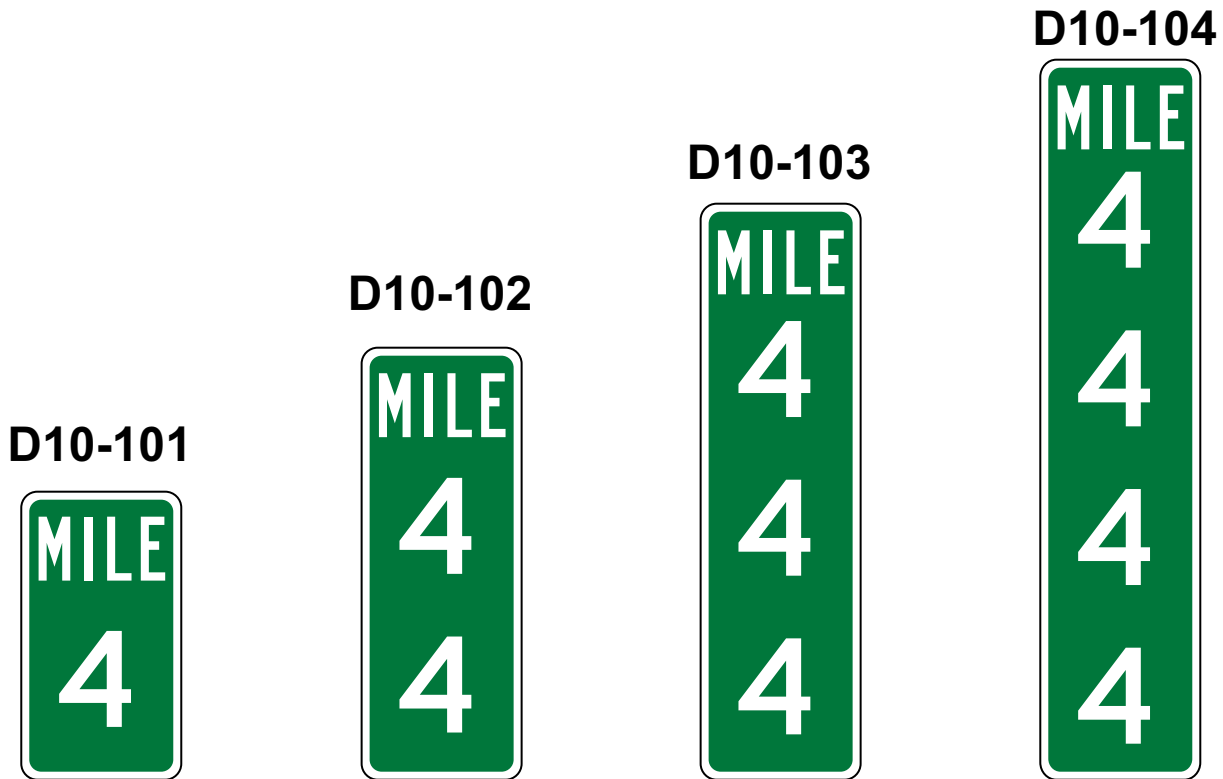

Border and Legend: White
Background: Green

Sign Number	Dimensions (inches)				
	Sign Size	Letter Size and Series	Num. Size and Series	Border Width	Corner Radius
D10-101	10x18	4B	6D	0.5	1
	12x24	4C	10D	0.75	1.5
D10-102	10x27	4B	6D	0.5	1
	12x36	4C	10D	0.75	1.5
D10-103	10x36	4B	6D	0.5	1
	12x48	4C	10D	0.75	1.5
D10-104	10x45	4B	6D	0.5	1
	12x60	4C	10D	0.75	1.5

Message on one
side of sign

D10-101A
D10-102A
D10-103A
D10-104A

D10-104A

D10-101A



D10-102A



D10-103A



Border and Legend: White
Background: Green

Sign Number	Sign Size	Letter Size and Series	Num. Size and Series	Border Width	Corner Radius
D10-101A	10 x 27	4B	6D	0.5	1
	12 x 36	4C	10D	0.75	1.5
D10-102A	10 x 36	4B	6D	0.5	1
	12 x 48	4C	10D	0.75	1.5
D10-103A	10 x 45	4B	6D	0.5	1
	12 x 60	4C	10D	0.75	1.5
D10-104A	10 x 54	4B	6D	0.5	1
	12 x 72	4C	10D	0.75	1.5

Message on both
sides of sign

D10-201
D10-202
D10-203
D10-204

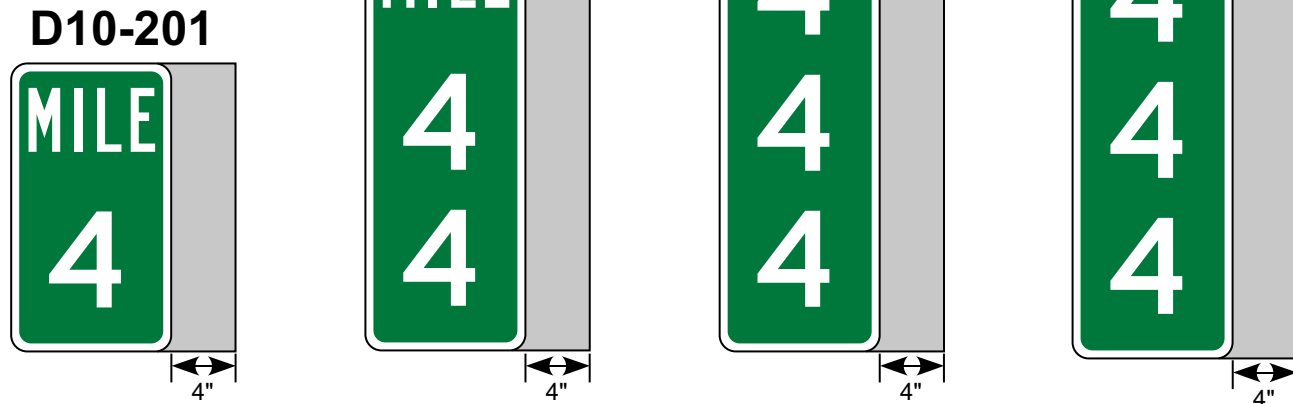

Note: 4" mounting area may be bare aluminum or green reflective material.

Border and Legend: White
Background: Green

Sign Number	Sign Size	Dimensions (inches)			
		Letter Size and Series	Num. Size and Series	Border Width	Corner Radius
D10-201	14 x 18	4B	6D	0.5	1
	16 x 24	4C	10D	0.75	1.5
D10-202	14 x 27	4B	6D	0.5	1
	16 x 36	4C	10D	0.75	1.5
D10-203	14 x 36	4B	6D	0.5	1
	16 x 48	4C	10D	0.75	1.5
D10-204	14 x 45	4B	6D	0.5	1
	16 x 60	4C	10D	0.75	1.5

D10-201A
D10-202A
D10-203A
D10-204A

**Message on both
sides of sign**

D10-204A

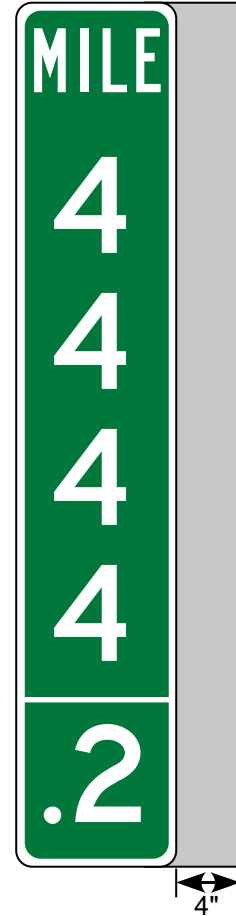

Note: 4" mounting area may be bare aluminum or green reflective material.

Border and Legend: White
Background: Green

Dimensions (inches)

Sign Number	Sign Size	Letter Size and Series	Num. Size and Series	Border Width	Corner Radius
D10-201A	14 x 27	4B	6D	0.5	1
	16 x 36	4C	10D	0.75	1.5
D10-202A	14 x 36	4B	6D	0.5	1
	16 x 48	4C	10D	0.75	1.5
D10-203A	14 x 45	4B	6D	0.5	1
	16 x 60	4C	10D	0.75	1.5
D10-204A	14 x 54	4B	6D	0.5	1
	16 x 72	4C	10D	0.75	1.5

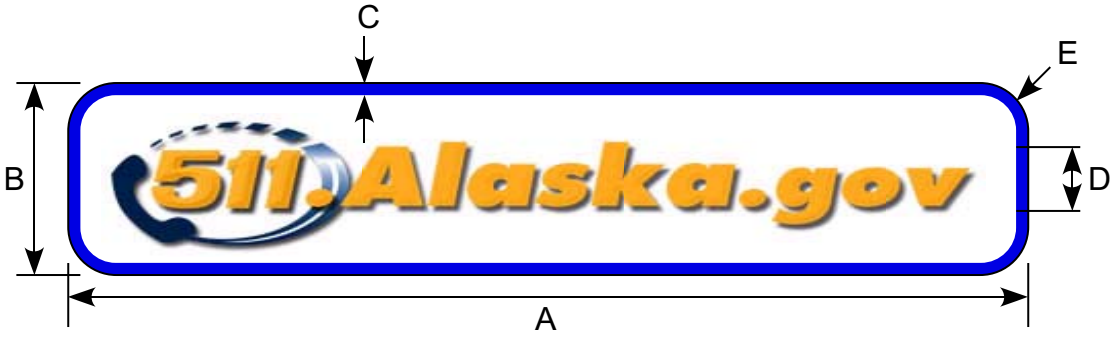

Use only below D12-5 or D12-5a

Only use plate with above sign off roads, for example at Ferry & Airport Terminals and Road Side Rest Areas.

* Make symbol and lettering proportional to graphic shown.

Border and Symbol: Blue
Legend: Orange
Background: White

Road Class	A	B	C	D	E
Off Roads (Terminals)	30	6.0	0.38	2.0	1.5



Border and Legend: White
 Background: Blue

*Make symbol proportional to the graphic shown.

Road Class	Dimensions (inches)									
	A	B	C	D	E	F	G	H	J	K
Conv & Min	30	24	12	0.75	1.5	2.5	4C	3.5	2	3C

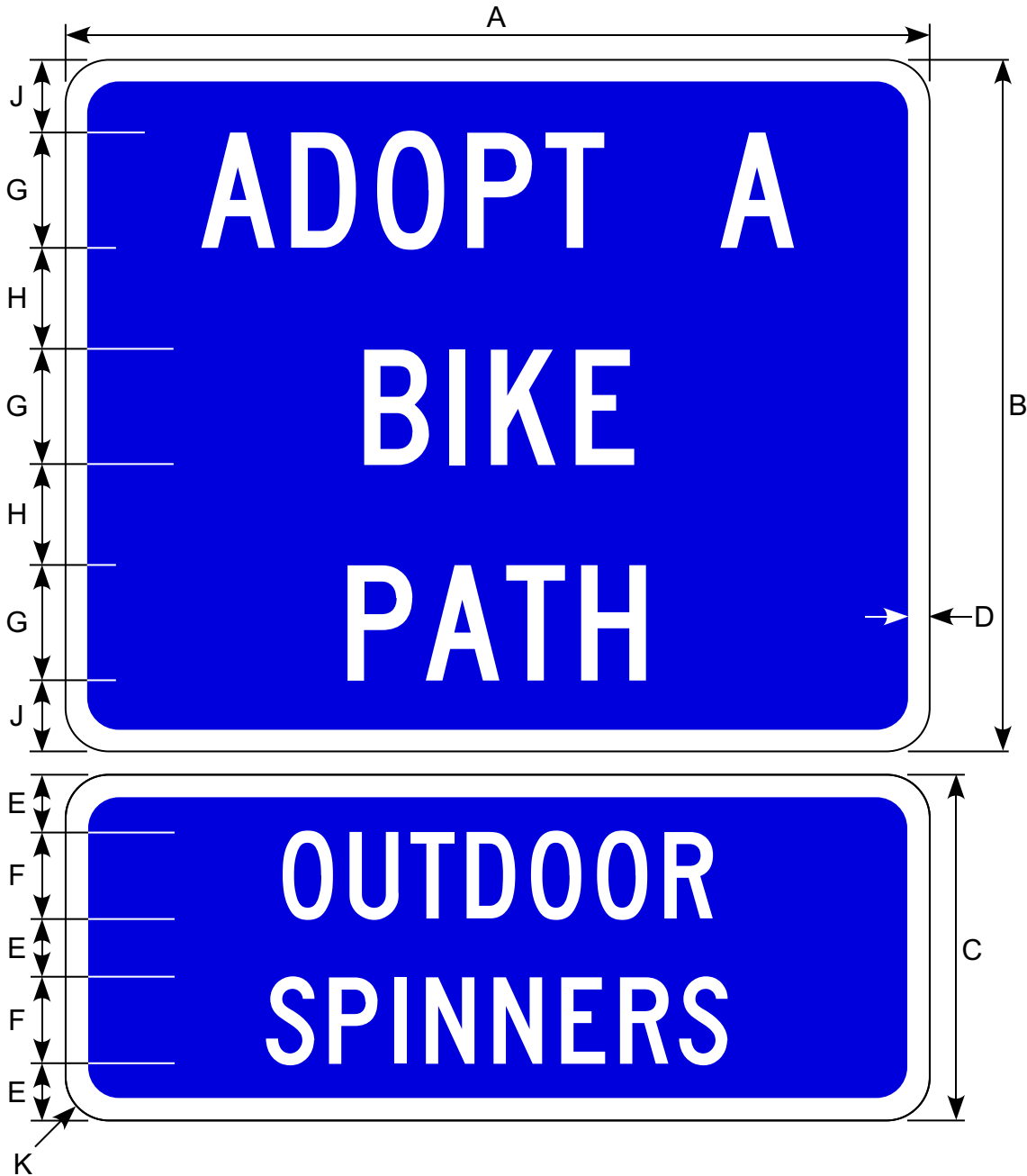

Border and Legend: White
 Background: Blue

Class	A	B	C	D	E	F	G	H	J	K
Minimum	24	18	12	0.75	2	3C	3C	3.0	1.5	1.5
Conventional	30	24	12	0.75	2	3C	4C	3.5	2.5	2.0

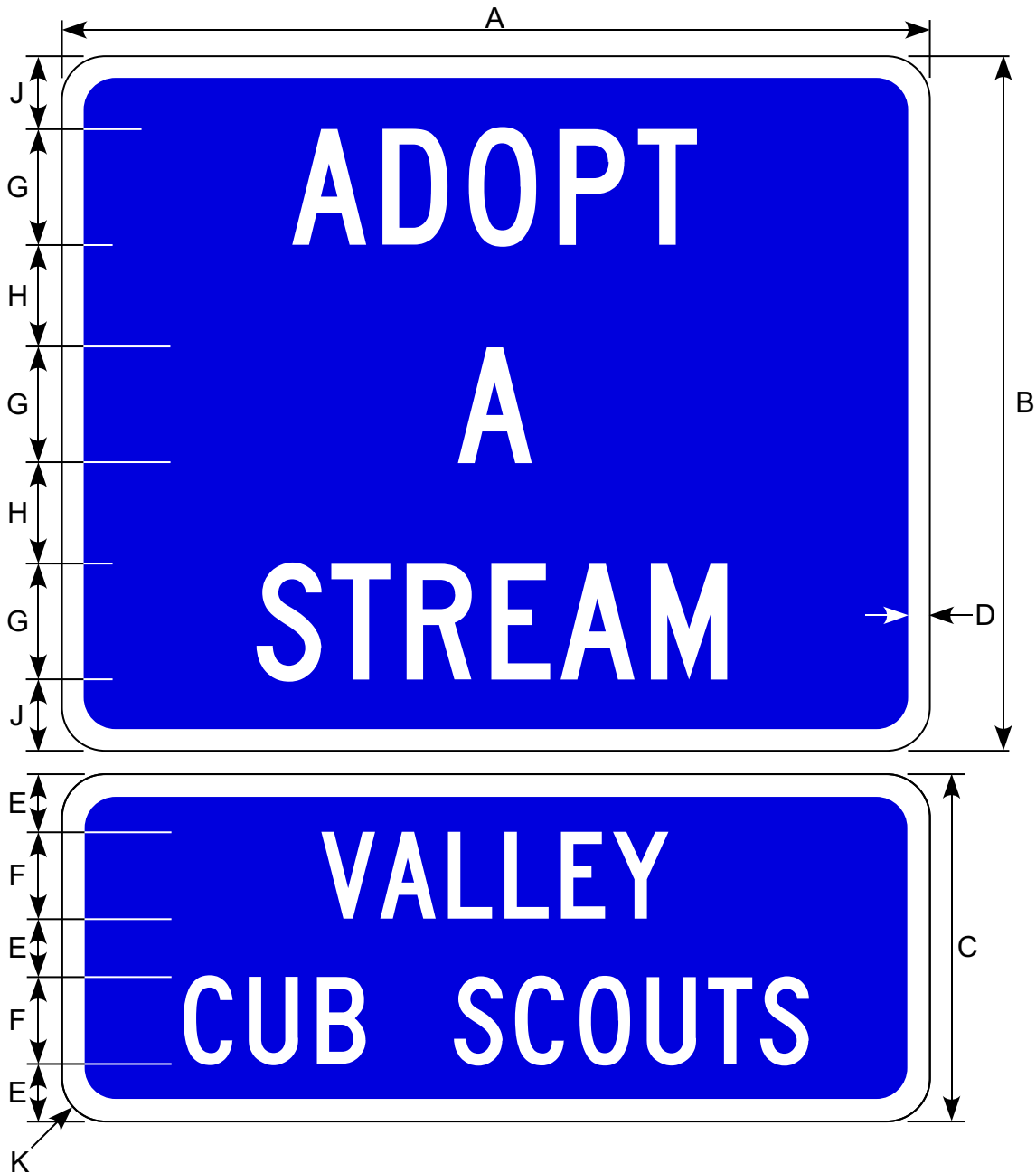

Border and Legend: White
 Background: Blue

Class	A	B	C	D	E	F	G	H	J	K
Min	24	18	12	0.75	2	3C	3C	3.0	1.5	1.5
Conv	30	24	12	0.75	2	3C	4C	3.5	2.5	2.0

I Series

GENERAL INFORMATION SIGNS

ASDS SUPPLEMENT SIGNS

I-101 to I-231



Border and Legend: White
Background: Green

Road Class	Dimensions (inches)								
	A	B	C	D	E	F	G	H	J
Conventional	VAR	36	1.0	8±	6D	6.0	8/6D	51.5	2.25

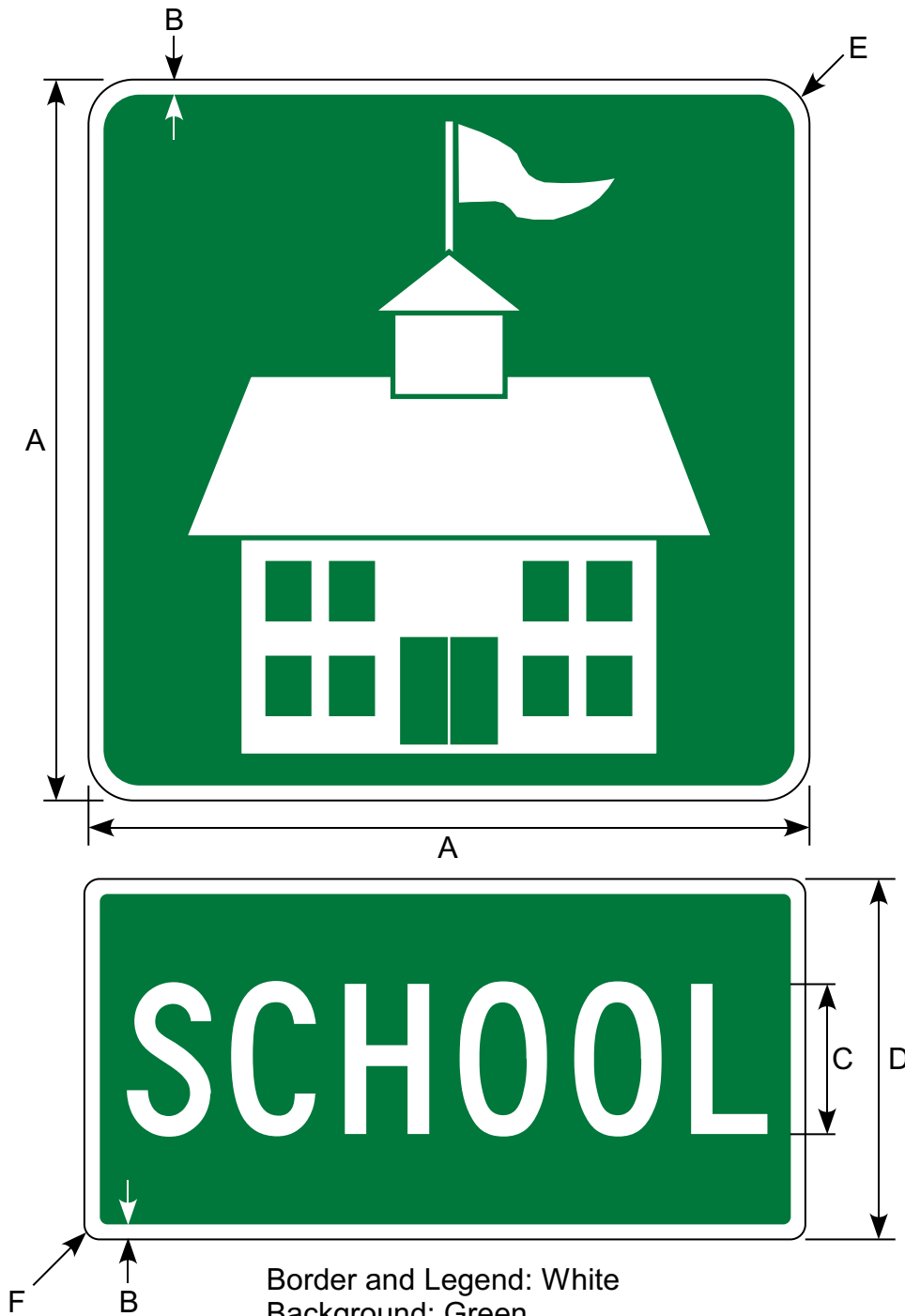

Border and Legend: White
Background: Green

Make symbol proportional to graphic shown

If school names are shown instead of "SCHOOL" on the plate, use 4" Series C letters until the plate exceeds the width of the symbol sign. At greater widths, use 4" Series B. One, two, and three line signs should be 12", 18", and 24" high, respectively for both minimum and conventional road classes.

Road Class	Dimensions (inches)					
	A	B	C	D	E	F
Min	24	0.50	5C	12	1.5	0.50
Conv	30	0.75	6C	12	1.88	0.75

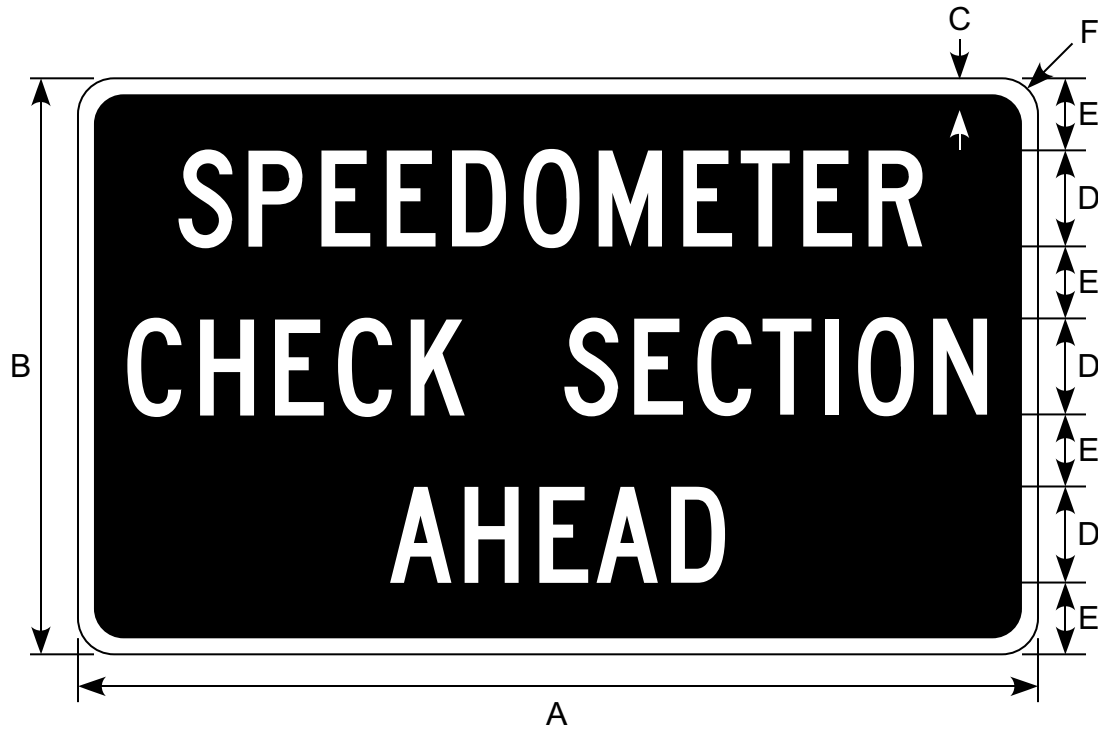

Border and Legend: White
 Background: Black

Road Class	Dimensions (inches)					
	A	B	C	D	E	F
Min & Conv	60	36	1	6C	4.5	2.25

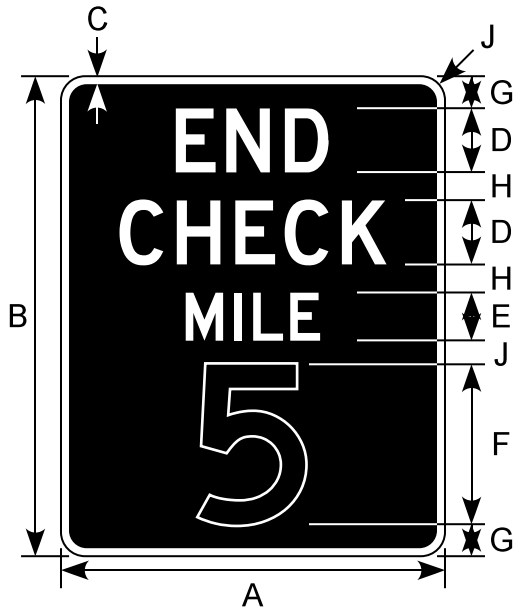

I-141E

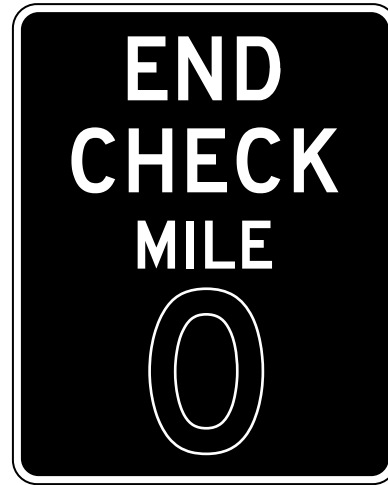

I-141B

Border and Legend: White
Background: Black

Miles are variable

Road Class	Dimensions (inches)									
	A	B	C	D	E	F	G	H	J	
Min & Conv	24	30	0.50	4D	3D	10D	2.0	1.75	1.5	

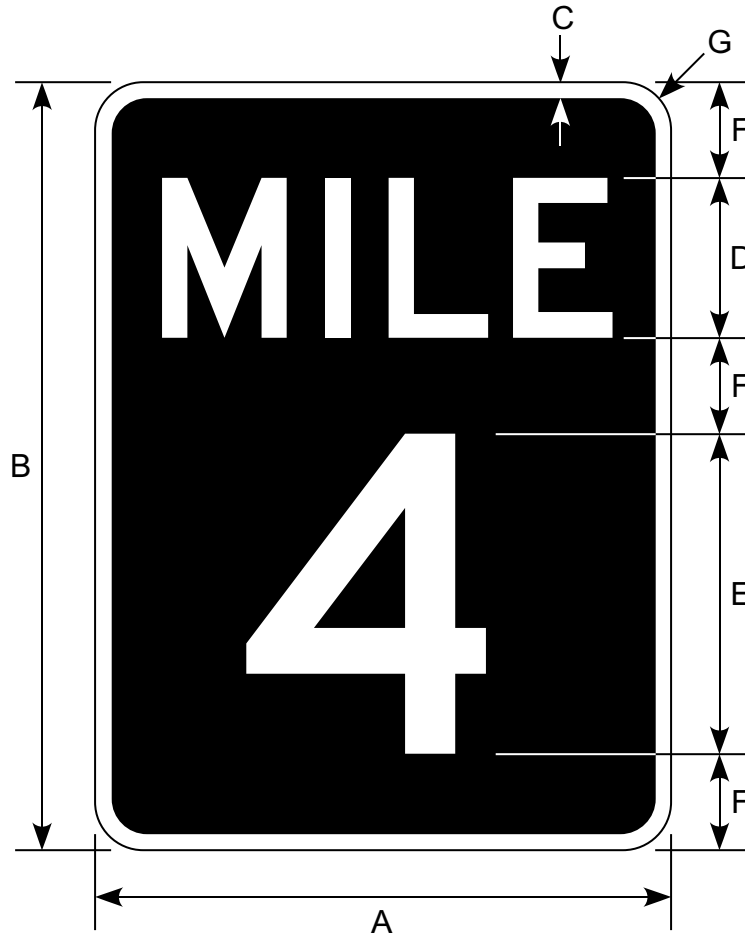

Border and Legend: White
 Background: Black

Road Class	Dimensions (inches)						
	A	B	C	D	E	F	G
Min & Conv	18	24	0.5	5D	10D	3	1.5



Border and Legend: White
 Background: Blue

Road Class	Dimensions (inches)							
	A	B	C	D	E	F	G	H
Conv & Min	30	36	1	3.5	5C	2	4E	1.88



Border and Legend: White
 Background: Blue

Road Class	Dimensions (inches)					
	A	B	C	D	E	F
Conv & Min	30	0.75	1.88	4.5	5C	3

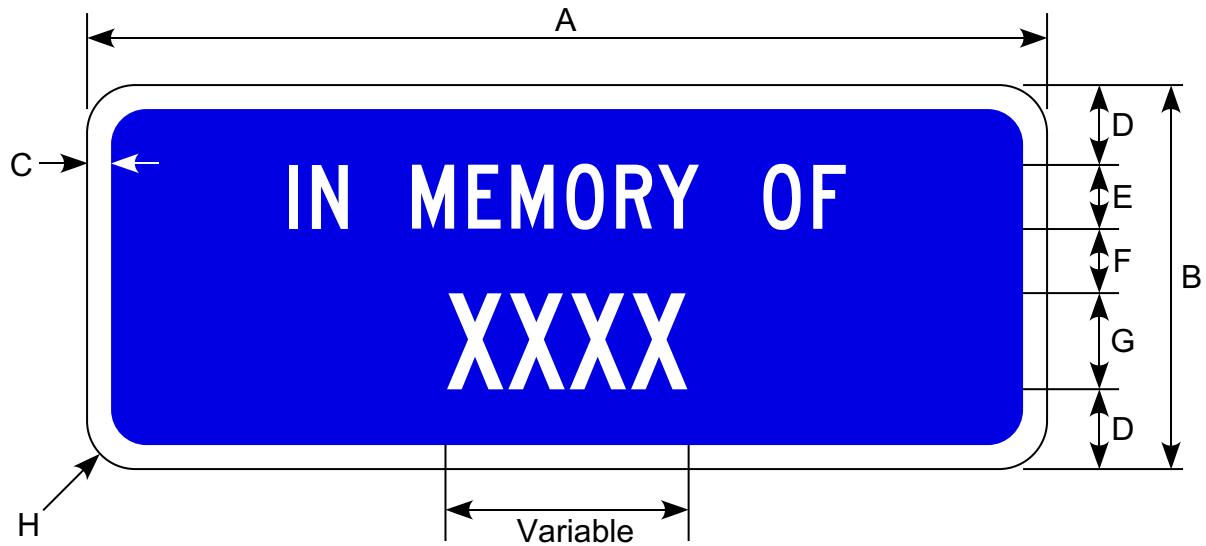

Border and Legend: White
Background: Blue

This plaque may be used in conjunction with a "PLEASE DON'T DRINK AND DRIVE" or a "PLEASE DRIVE SAFELY" sign.

Road Class	Dimensions (inches)							
	A	B	C	D	E	F	G	H
Conv & Min	30	12	0.75	2.5	2C	2.0	3C*	1.5

* If the name is too long to fit, letter size may be reduced to 2" Series C. A 2.5" margin shall be maintained on either side of the name.

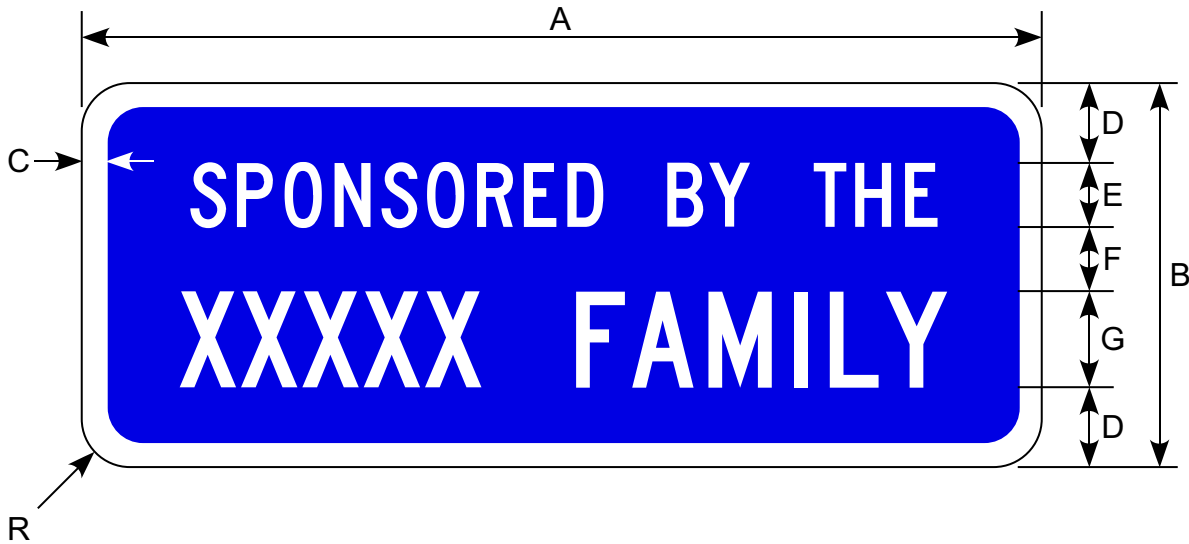

Border and Legend: White
Background: Blue

This plaque may be used in conjunction with
"PLEASE DON'T DRINK AND DRIVE" (i-160).

Road Class	Dimensions (inches)							
	A	B	C	D	E	F	G	R
Conv & Min	30	12	0.75	2.5	2C	2.0	3C*	1.5

*If the name is too long to fit, letter size may be reduced to 2" Series C.
A 2.5" margin shall be maintained on either side of the name.

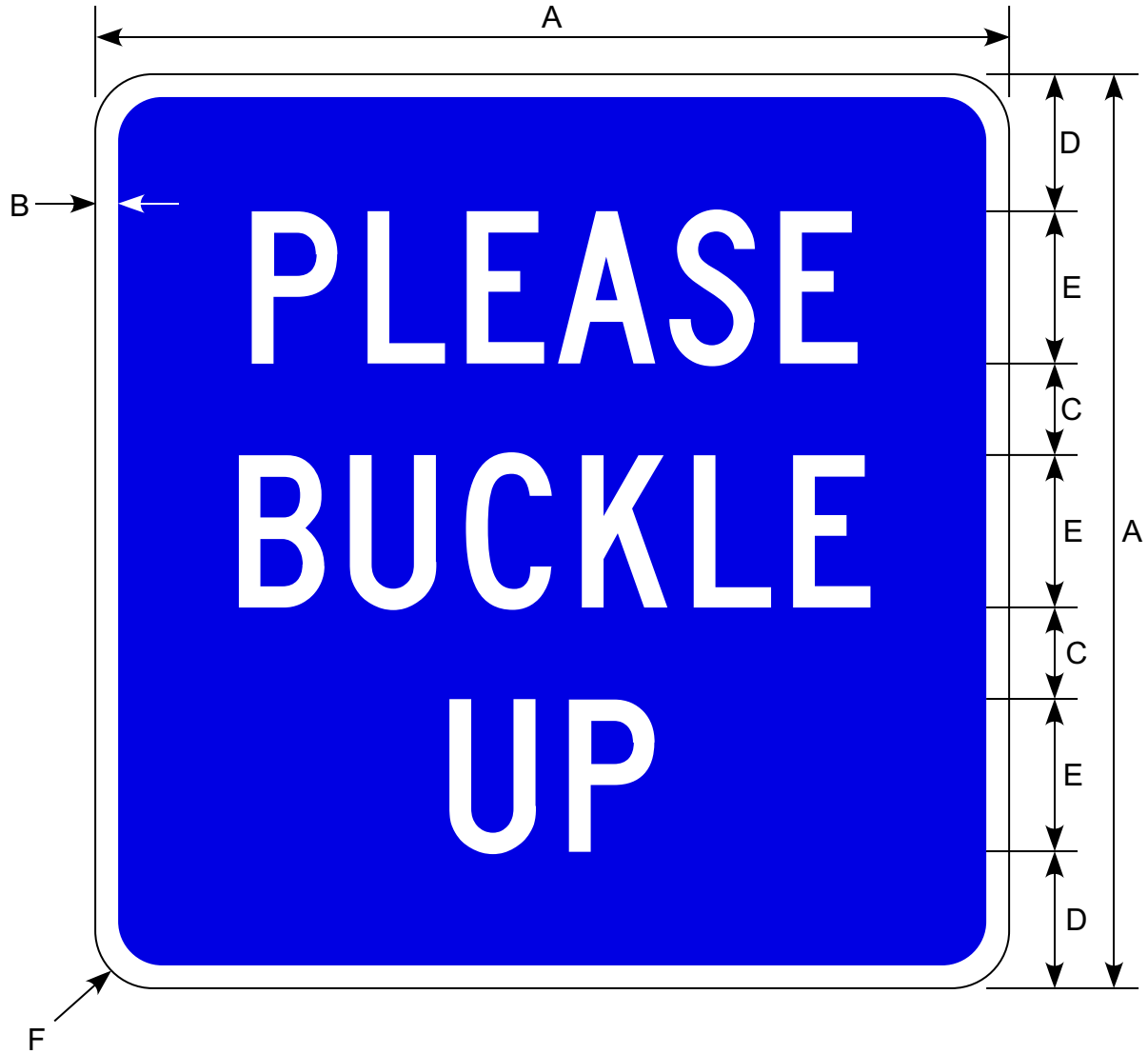

Border and Legend: White
 Background: Blue

Road Class	Dimensions (inches)					
	A	B	C	D	E	F
Conv & Min	30	0.75	3	4.5	5C	1.88

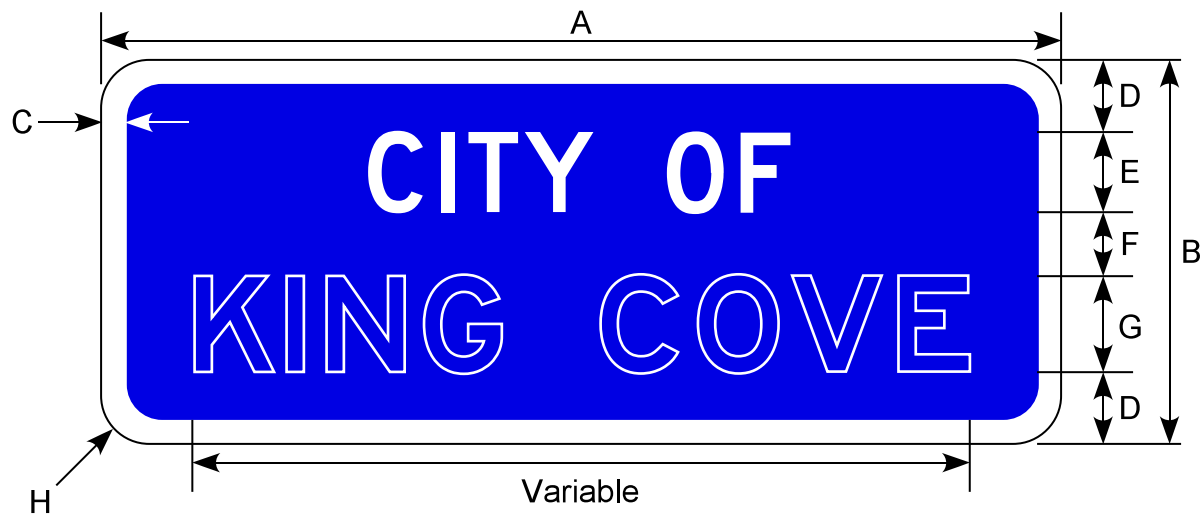

Border and Legend: White
Background: Blue

This plaque may be installed above a I-160
"PLEASE DON'T DRINK AND DRIVE" sign.

Road Class	Dimensions (inches)							
	A	B	C	D	E	F	G	H
Conv & Min	30	12	0.75	2.25	2.5D	2.0	3E*	1.5

* If the city name is too long to fit, change lettering to the narrowest series that allows a 2" margin on both sides.

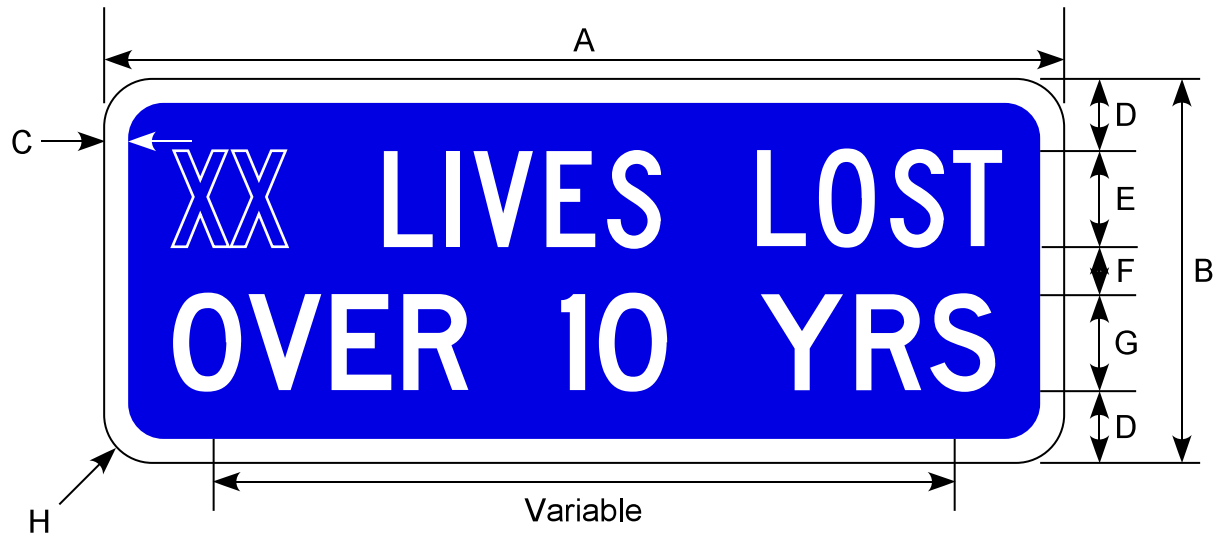

Border and Legend: White
Background: Blue

This plaque may be installed above a I-160
"PLEASE DON'T DRINK AND DRIVE" sign if a I-165
sign is mounted above that sign.

Road Class	Dimensions (inches)							
	A	B	C	D	E	F	G	H
Conv & Min	30	12	0.75	2.25	3C	1.5	3D	1.5



Border and Legend: White
 Background: Blue

Road Class	Dimensions (inches)							
	A	B	C	D	E	F	G	H
Conv & Min	30	36	1	3.5	5C	2	4E	1.88

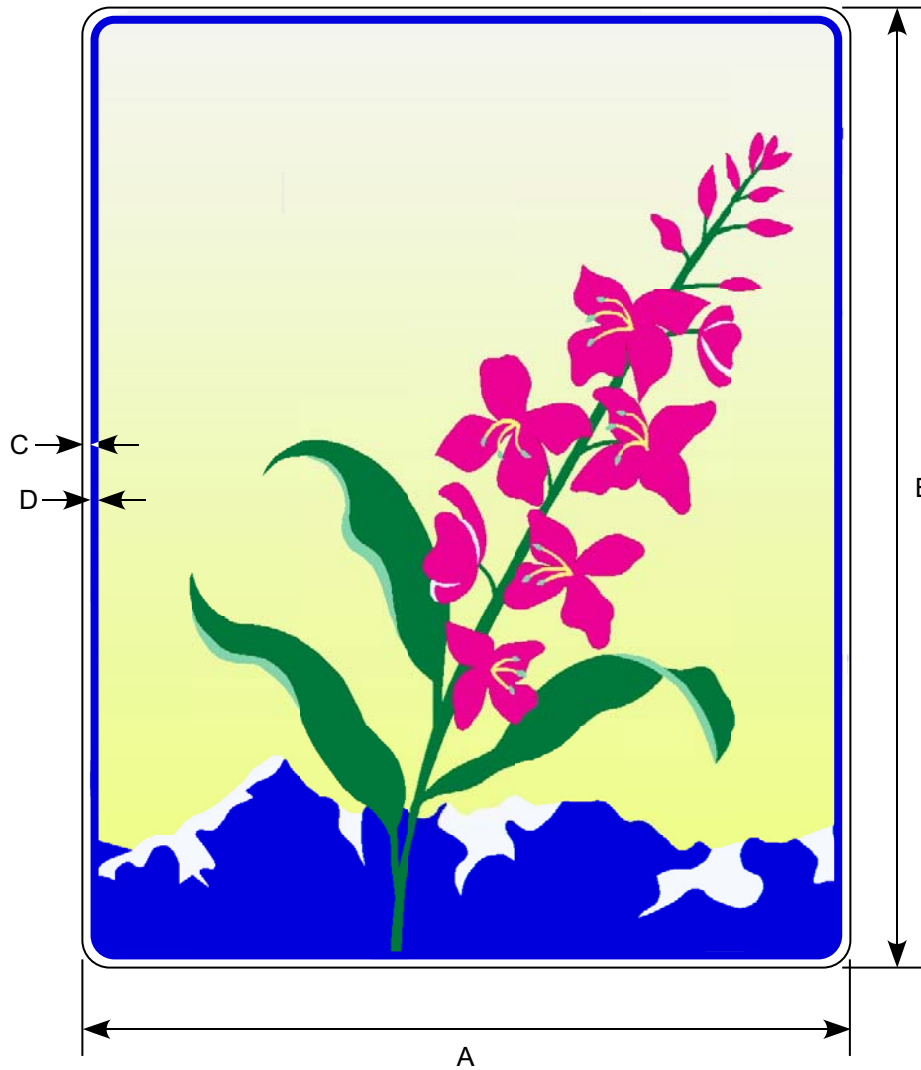

Sign graphics may be obtained in electronic form from the ADOT&PF State Traffic Engineer.

Use the following 3M Series 700 Colors or approved equivalents:
 708 Green (Two shades -100% and XX%)
 710 Blue
 722 Lemon Yellow (100% to 0% gradient)
 723 Magenta

Road Class	Dimensions (inches)			
	A	B	C	D
Std & Min	24	30	0.38	0.63



Sign graphics may be obtained in electronic form from the ADOT&PF State Traffic Engineer.

Use the following 3M Series 700 Colors or approved equivalents:
 708 Green (Two shades -100% and 50%)
 710 Blue
 722 Lemon Yellow (100% to 0% gradient)
 723 Magenta

Make graphic and lettering proportional to those shown. Adjust as necessary to fit 24"x 30" sign size.

Road Class	Dimensions (inches)			
	A	B	C	D
Minimum	24	30	0.38	0.63
Standard	36	48	0.63	0.88

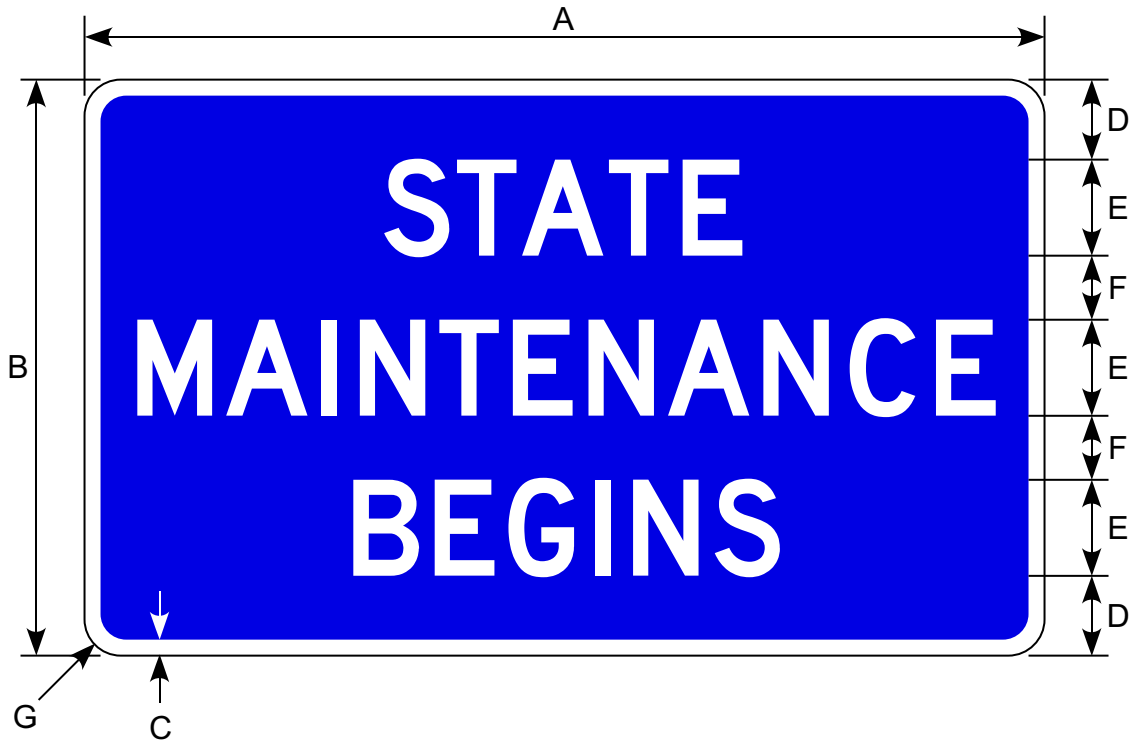

Border and Legend: White
 Background: Blue

Road Class	Dimensions (inches)						
	A	B	C	D	E	F	G
Conv & min	30	18	0.5	2.5	3D	2	1.13

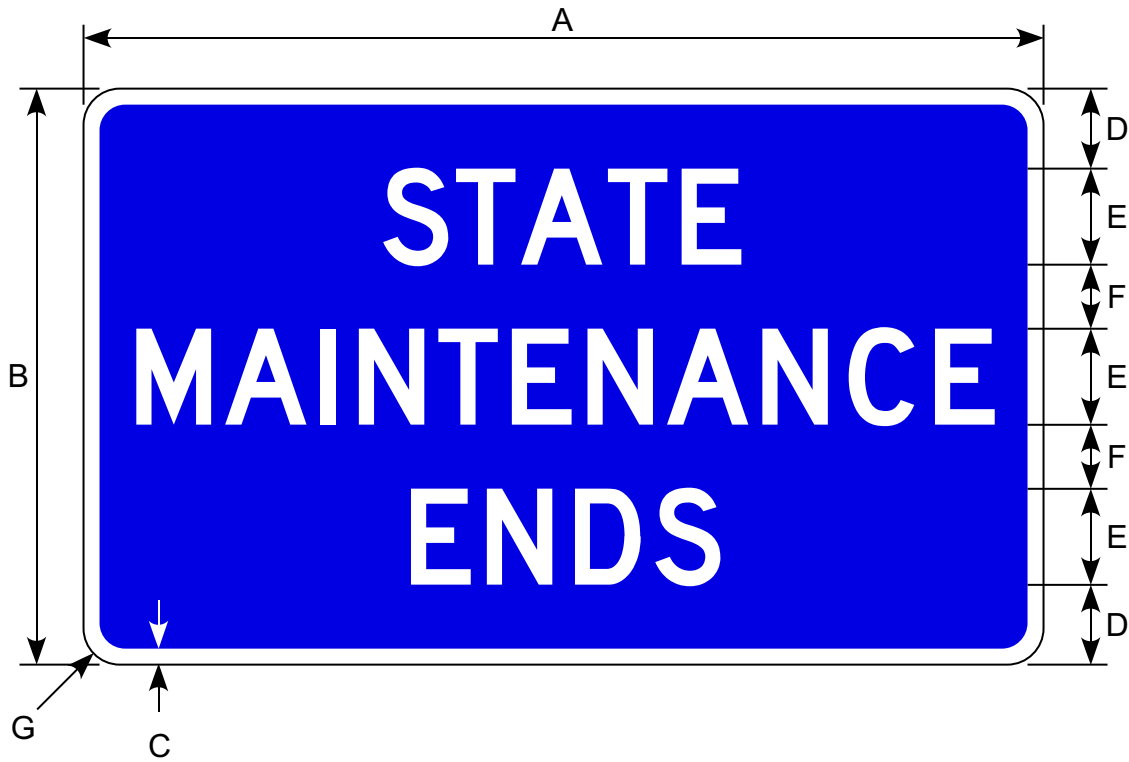

Border and Legend: White
 Background: Blue

Road Class	Dimensions (inches)						
	A	B	C	D	E	F	G
Conv & min	30	18	0.5	2.5	3D	2	1.13



Border and Legend: White
Background: Blue

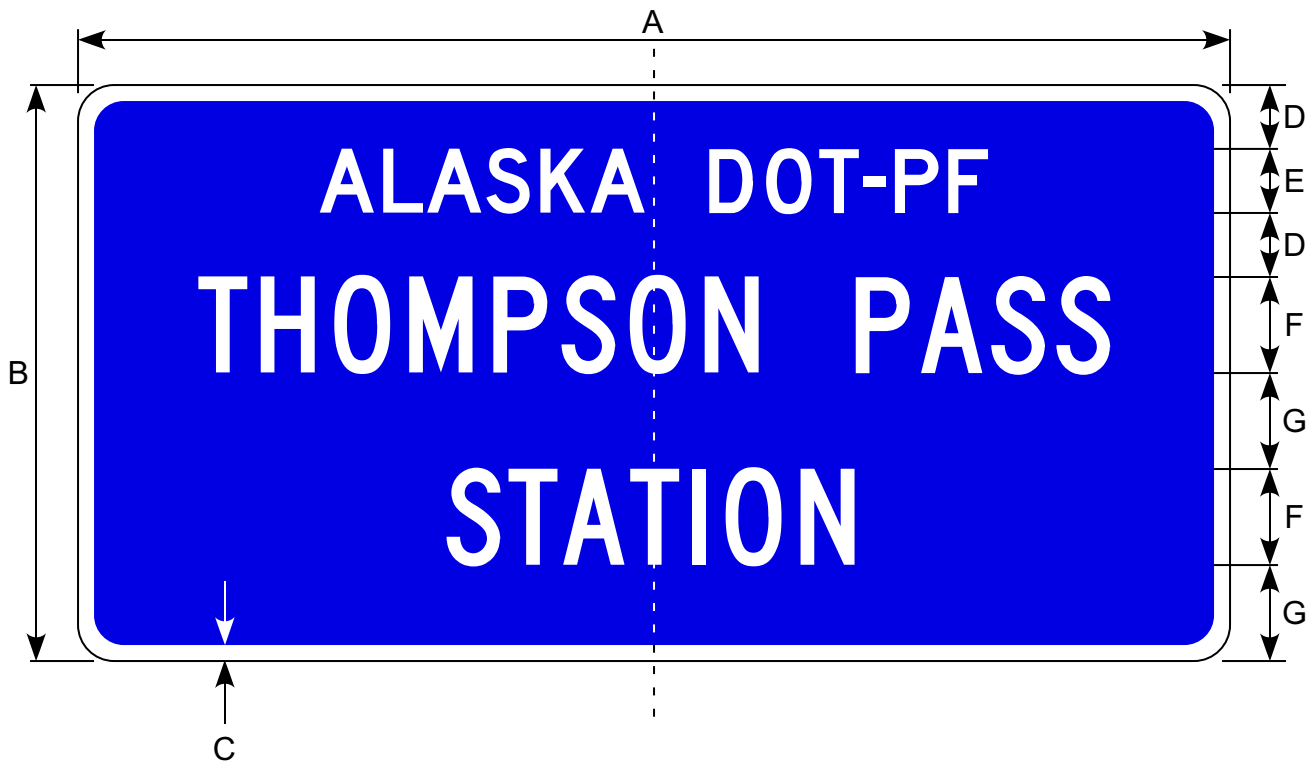

Border and Legend: White
 Background: Blue

Road Class	Dimensions (inches)							
	A	B	C	D	E	F	G	H
Conventional	Variable	36	1	4	4D	6C	6	2.25



Border and Legend: White
 Background: Blue

This sign is typically used with the
 ENFORCEMENT ENDS (R16-116) sign.

Road Class	Dimensions (inches)							
	A	B	C	D	E	F	G	H
Conv & Min	36	30	0.75	4.0	5B	3.5	2.25	5C

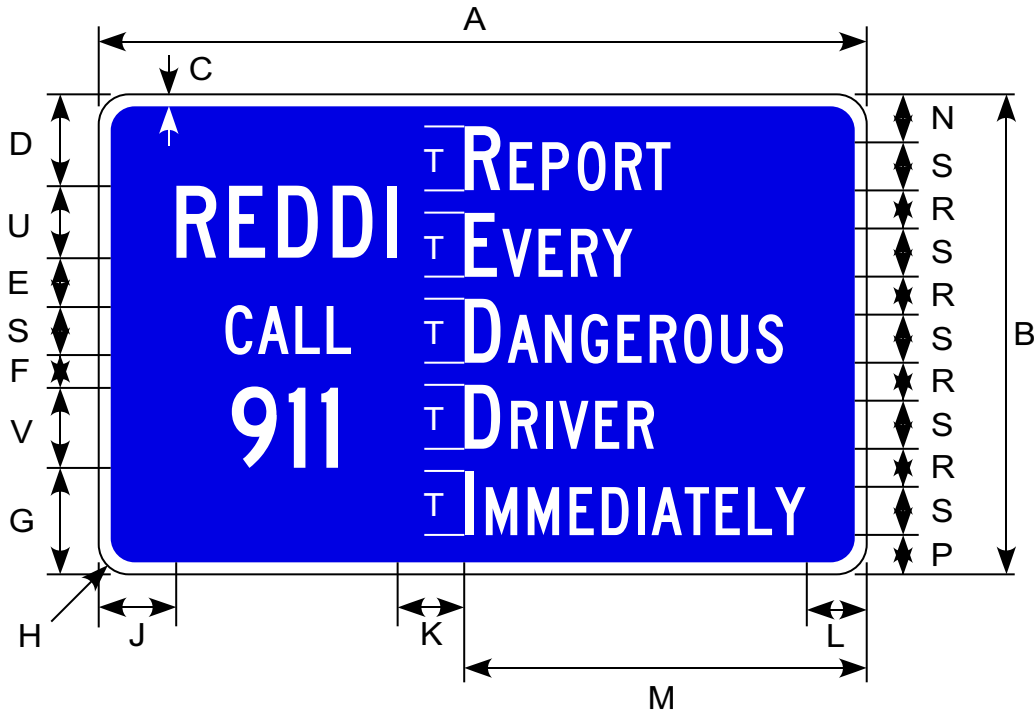

Border and Legend: White
Background: Blue

Letter Size (inches)	Dimensions (inches)																		
	A	B	C	D	E	F	G	H	J	K	L	M	N	P	R	S	T	U	V
6 / 4.5	60	48	1	11	4	3.5	12.5	3	4.5	6	5	31.1	5.5	4	4	4.5B	6B	6C	7C
8 / 6	96	60	1.5	11.5	6.1	4.1	13.3	3.75	9.7	8.3	7.5	50.3	6	5	4.75	6C	8C	9C	10C

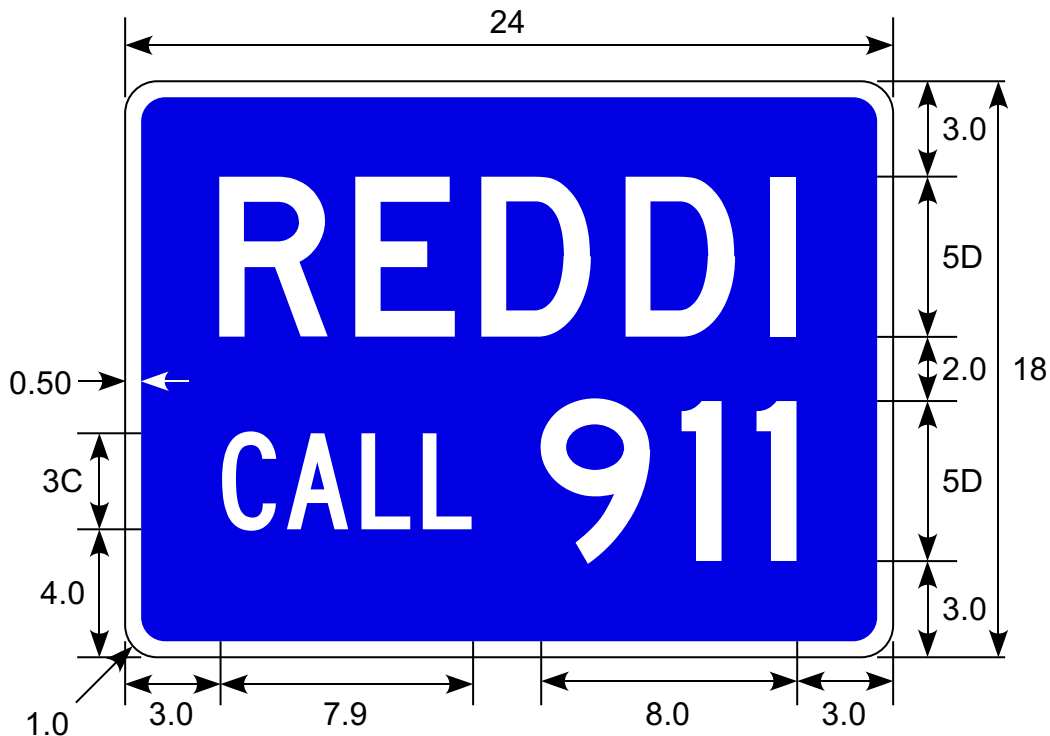

Border and Legend: White
 Background: Blue

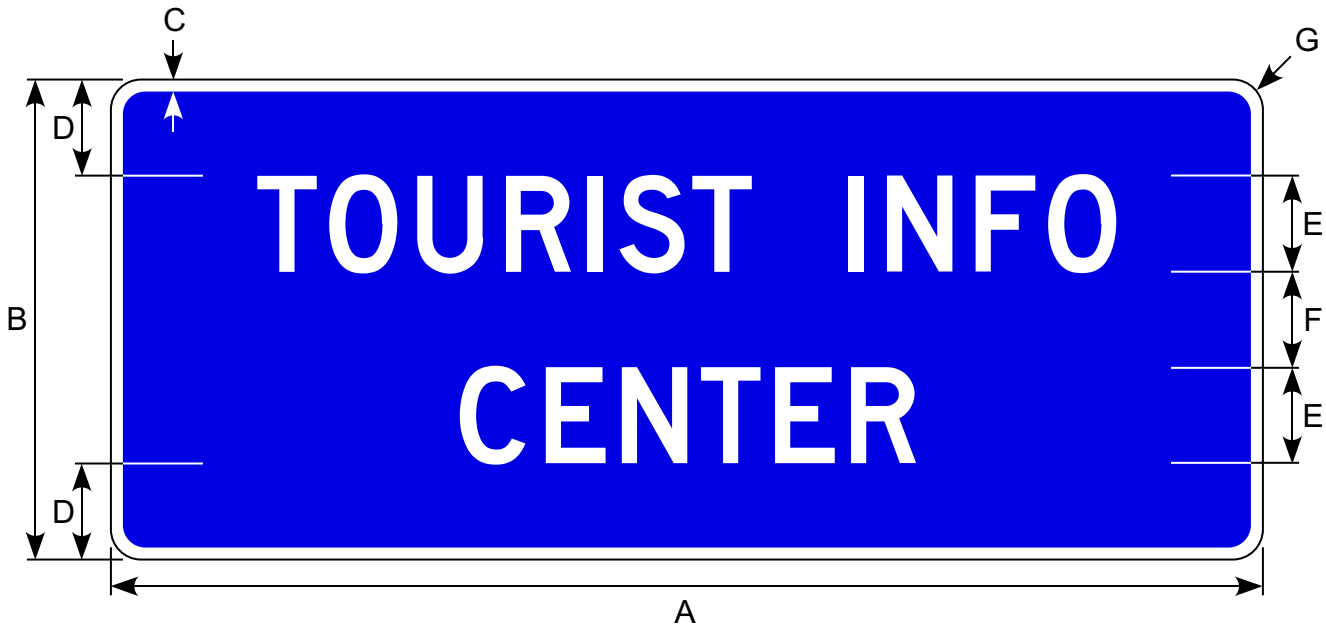

Border and Legend: White
 Background: Blue

Road	Dimensions (inches)						
Class	A	B	C	D	E	F	G
Conv & Min	72	30	0.75	6	6D	6	1.88
Expressway	90	36	1.00	6	8D	8	2.25
Freeway	120	54	1.25	10	12D	10	3.25

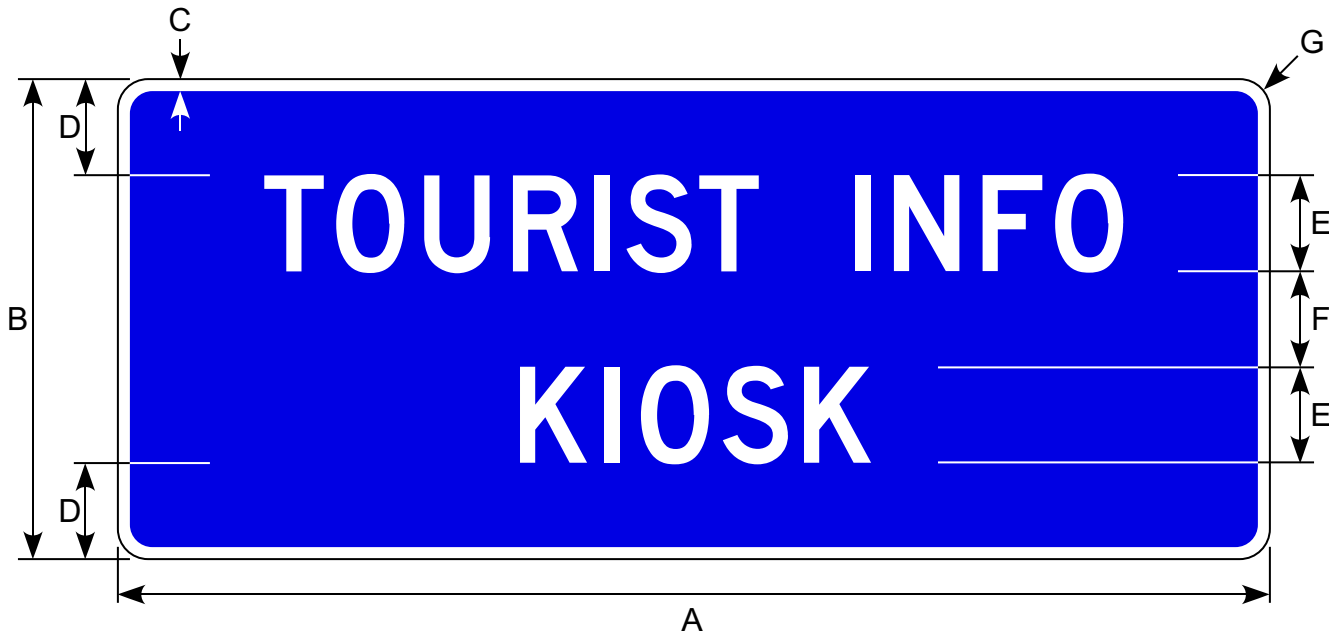

Border and Legend: White
 Background: Blue

Road	Dimensions (inches)						
Class	A	B	C	D	E	F	G
Conv & Min	72	30	0.75	6	6D	6	1.88
Expressway	90	36	1.00	6	8D	8	2.25
Freeway	120	54	1.25	10	12D	10	3.25



Legend: White
 Background: Green
 Route Plaque: Black on White

Use sign M1-5, scaled to 30" x 30"
 for the route marker

Use Photoshop file, available from the
 DOT&PF Headquarters Traffic and Safety
 Section, for the Purple Heart medal.

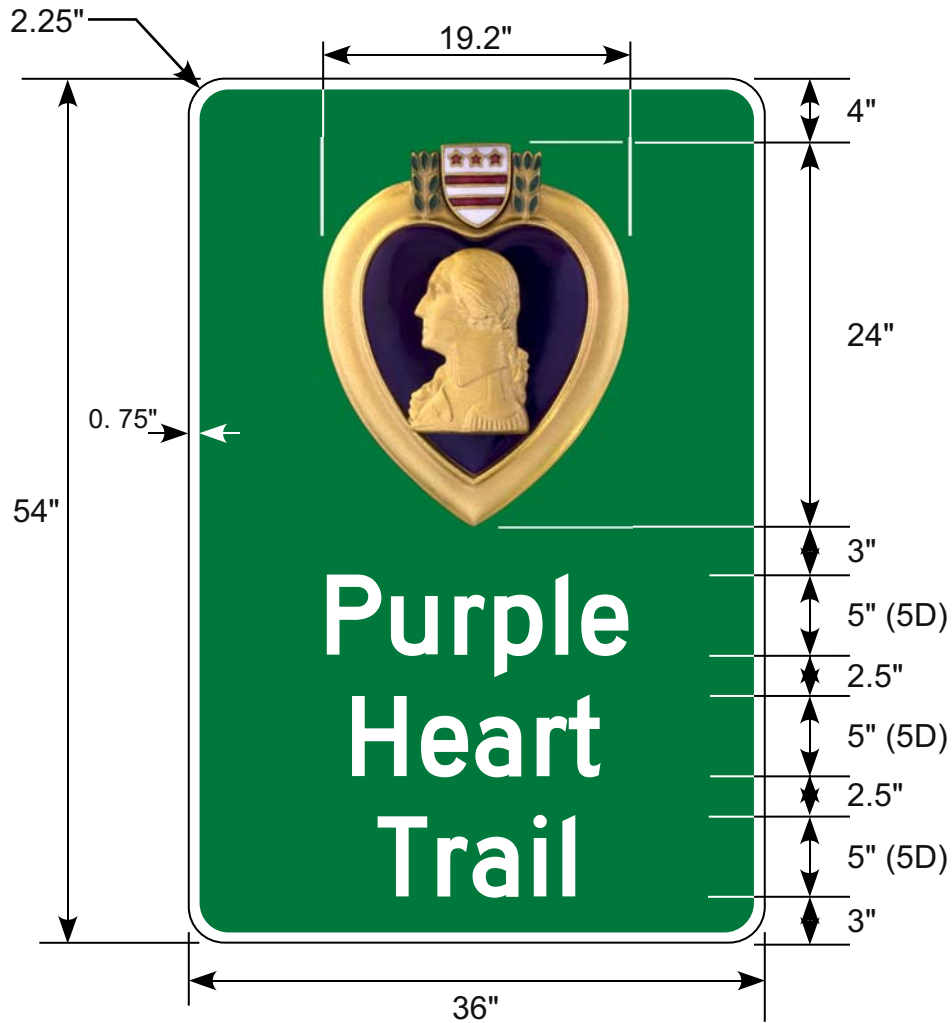

Border and Legend: White
 Background: Green
 Marker: Black on White

Use Photoshop file, available from the DOT&PF Headquarters Traffic and Safety Section, for the Purple Heart medal.



Border and Legend: White
 Background: Green

* Letters may be series C, D, or E

Road Class	Dimensions (inches)							
	A	B	C	D	E	F	G	H
Conventional	VAR	36	1.0	8±	8*	6.0	6D	2.25

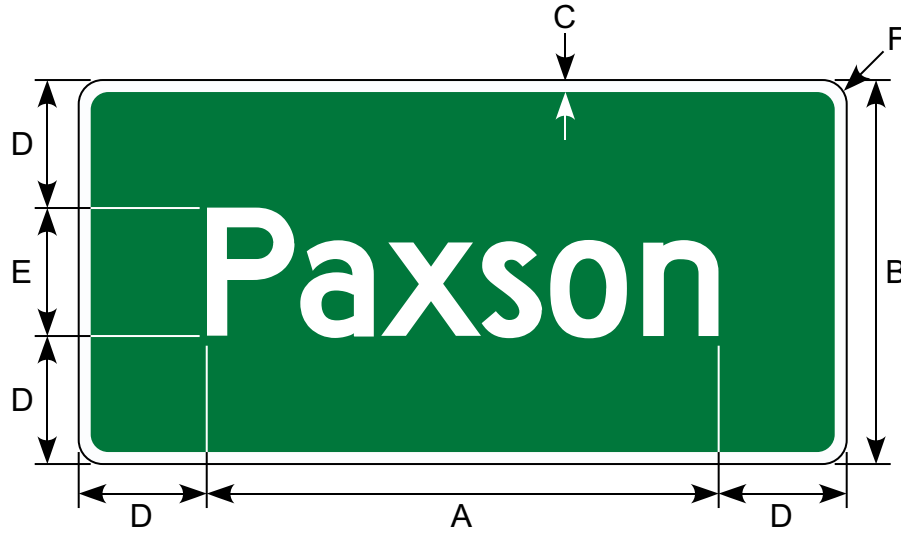

Border and Legend: White
 Background: Green

Road Class	Dimensions (inches)					
	A	B	C	D	E	F
Conventional	VAR	24	0.75	8±	8/6D	1.5

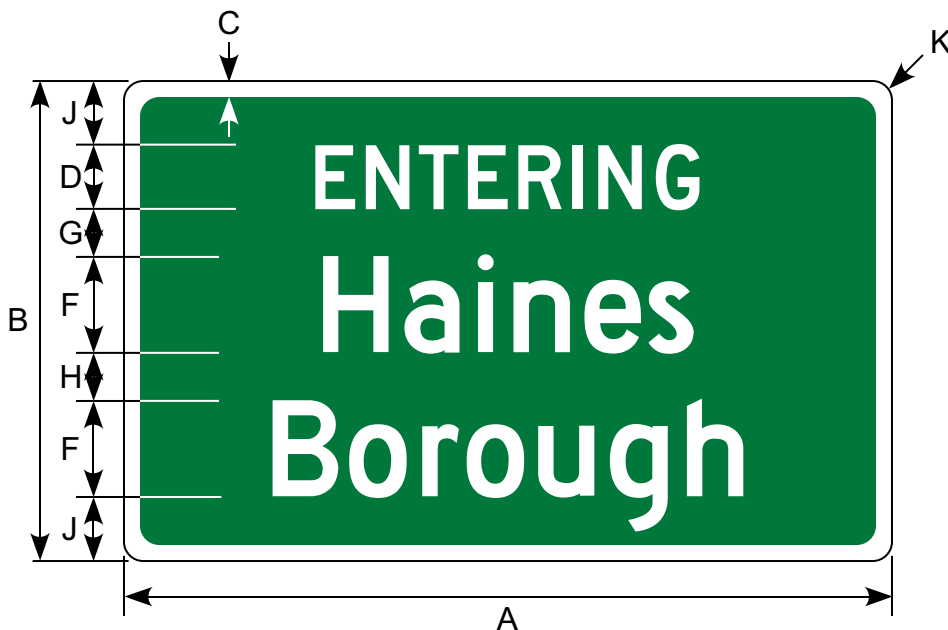

Border and Legend: White
 Background: Green

Road Class	Dimensions (inches)								
	A	B	C	D	F	G	H	J	K
Minimum	VAR	30	1.0	4D	6/4.5D	3	3	4	1.88
Conventional	VAR	48	1.3	6D	8/6D	6	6	7	3.00

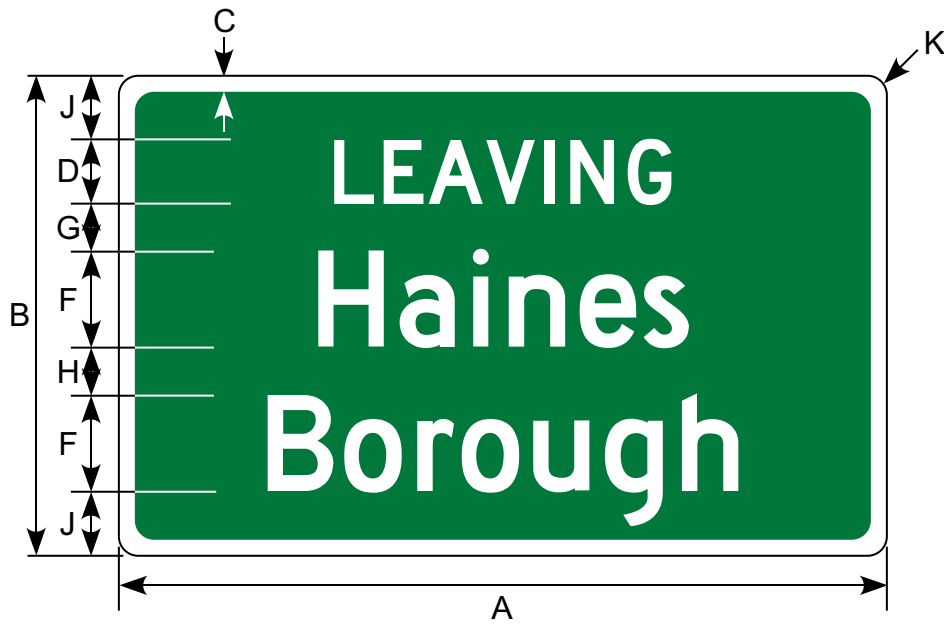

Border and Legend: White
 Background: Green

Road Class	Dimensions (inches)								
	A	B	C	D	F	G	H	J	K
Minimum	VAR	30	1.0	4D	6/4.5D	3	3	4	1.88
Conventional	VAR	48	1.25	6D	8/6D	6	6	7	3.00

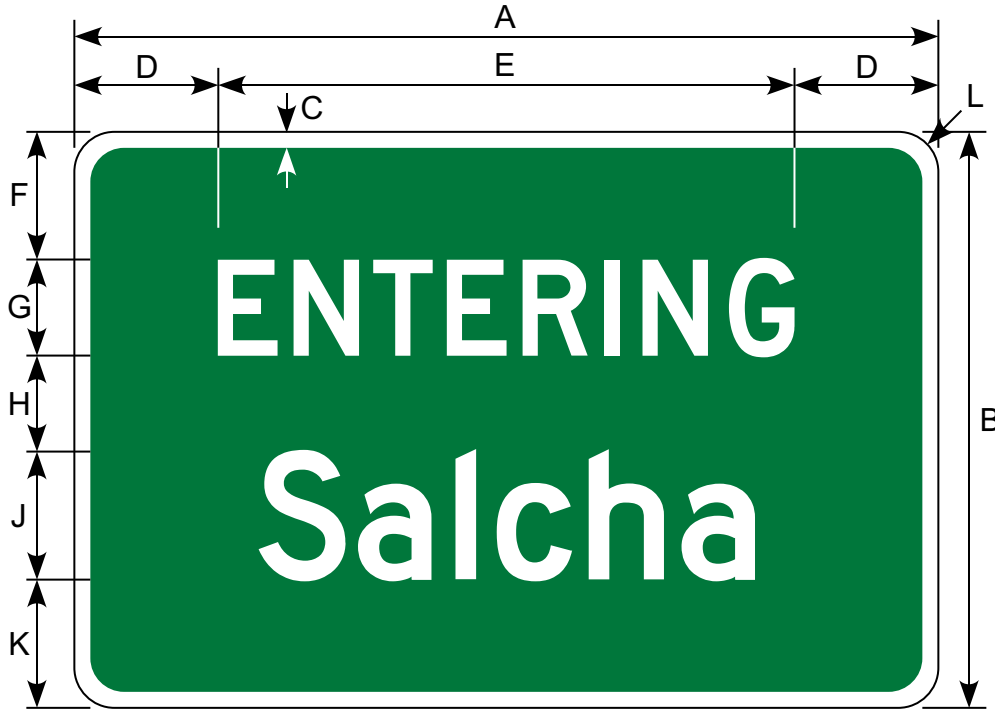

Border and Legend: White
 Background: Green

Road Class	Dimensions (inches)										
	A	B	C	D	E	F	G	H	J	K	L
Conventional	VAR	36	1.0	9±	VAR	8.0	6D	6.0	8/6D	8.0	2.5



Border and Legend: White
 Background: Brown

Road Class	Dimensions (inches)						
	A	B	C	D	E	F	G
Conv & Min	40	36	0.75	6	5D	4.5	2.25



Border and Legend: White
 Background: Brown

Road Class	Dimensions (inches)						
	A	B	C	D	E	F	G
Conv & Min	40	36	0.75	6	5D	4.5	2.25



Border and Legend: White
 Background: Brown

* Adjust character spacing of the word "SUBSISTENCE" to approximately 95% of full width spacing to create border width F.

Road Class	Dimensions (inches)						
	A	B	C	D	E	F	G
Conv & Min	42	42	0.75	5	5C	4.0	2.25

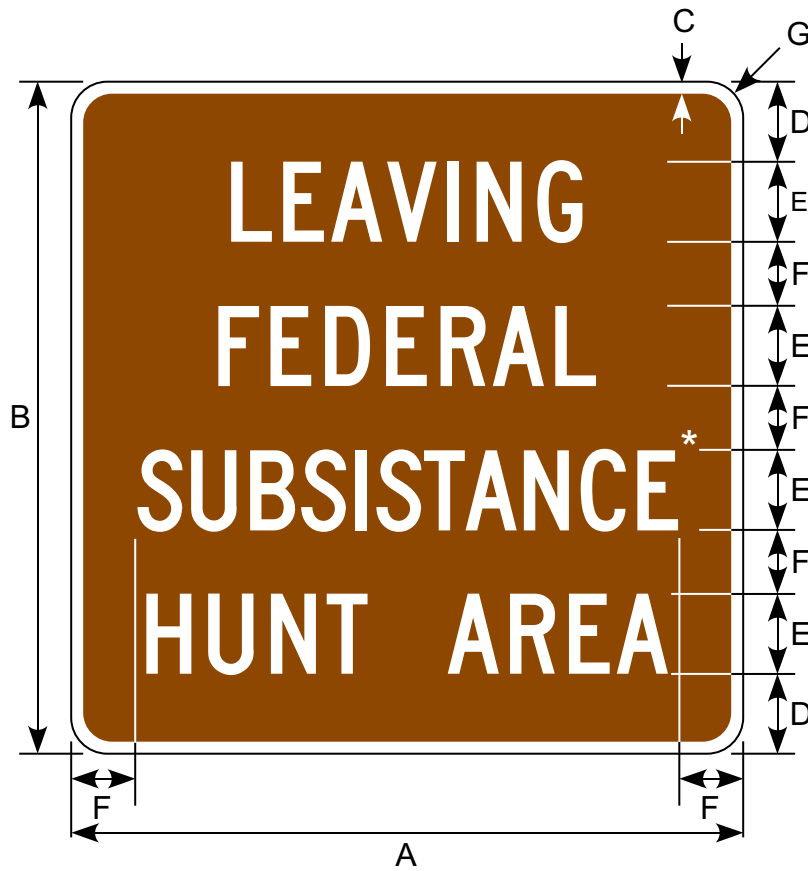

Border and Legend: White
 Background: Brown

* Adjust character spacing of the word "SUBSISTENCE" to approximately 95% of full width spacing to create border width F.

Road Class	Dimensions (inches)						
	A	B	C	D	E	F	G
Conv & Min	42	42	0.75	5	5C	4.0	2.25

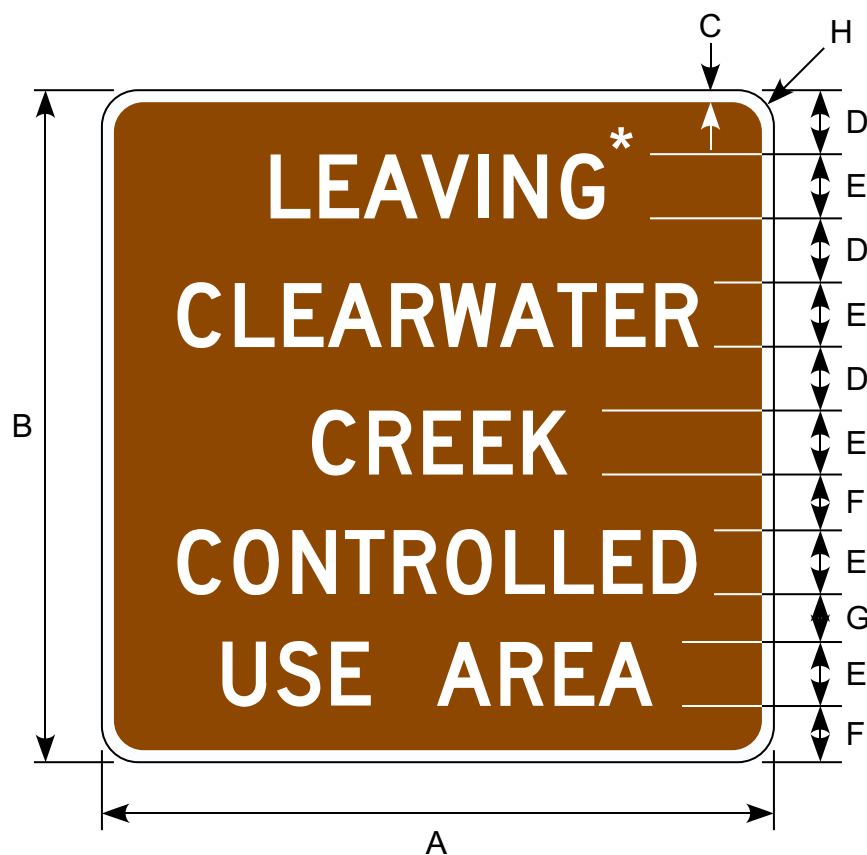

* Variable text:
ENTERING
LEAVING

Border and Legend: White
Background: Brown

Road Class	Dimensions (inches)							
	A	B	C	D	E	F	G	H
Conv & Min	42	42	0.75	4	4D	3.5	3.00	2.25

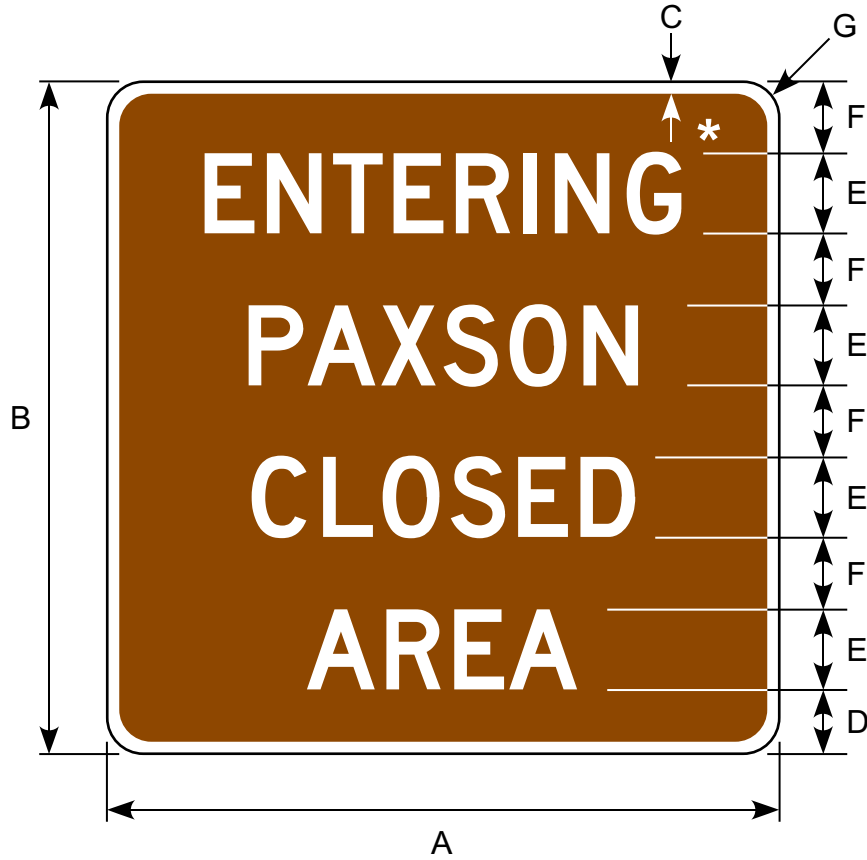

* Variable text:
 ENTERING
 LEAVING

Border and Legend: White
 Background: Brown

Road Class	Dimensions (inches)						
	A	B	C	D	E	F	G
Conv & Min	42	42	0.75	4	5D	4.5	2.25



Border and Legend: White
 Background: Green

Road Class	Dimensions (inches)							
	A	B	C	D	F	G	H	J
Minimum	VAR	24	0.75	6/4.5D	5D	5	4	1.50
Conventional	VAR	36	1.50	8/6D	6D	6	8	2.25

LG Series

BUSINESS LOGO SIGNS

ASDS SUPPLEMENT SIGNS

LG-F1x2 to LG-R1x3

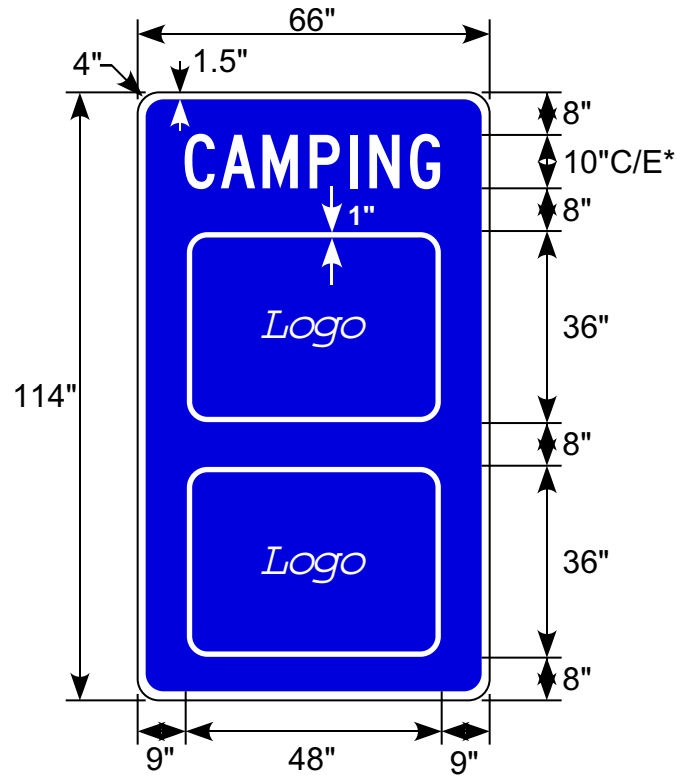

Border and Legend: White
Background: Blue

Alternative Headings:
CAMPING
FOOD
GAS
LODGING

* Use series E characters for "FOOD" and "GAS"
Use series C for "CAMPING" OR "LODGING".

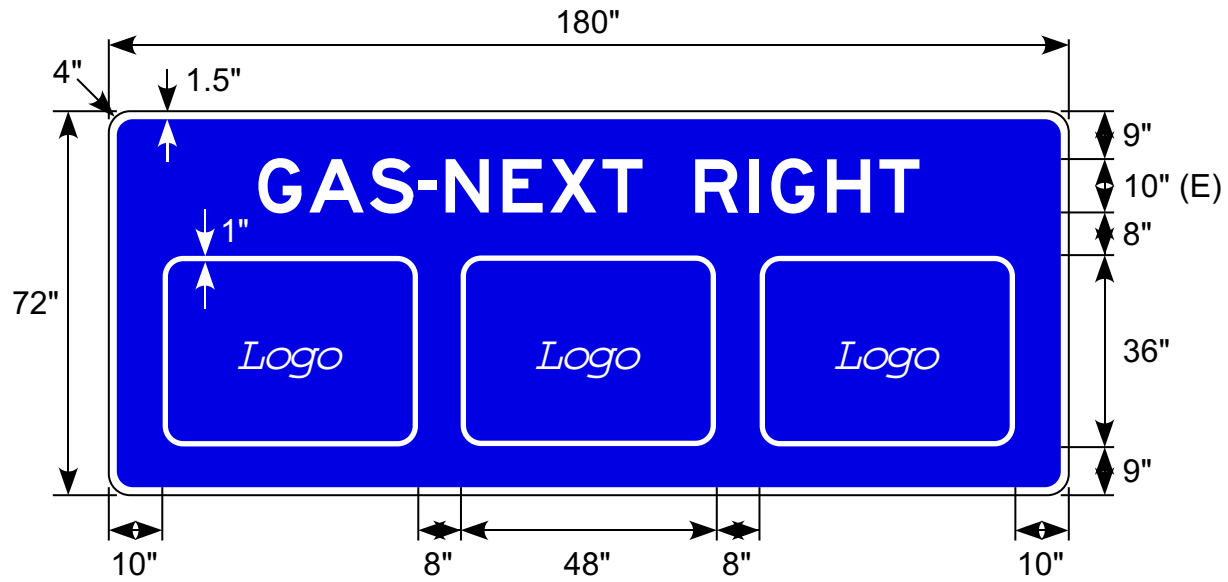

Border and Legend: White
Background: Blue

Alternative Service Types:
CAMPING
FOOD
GAS
LODGING

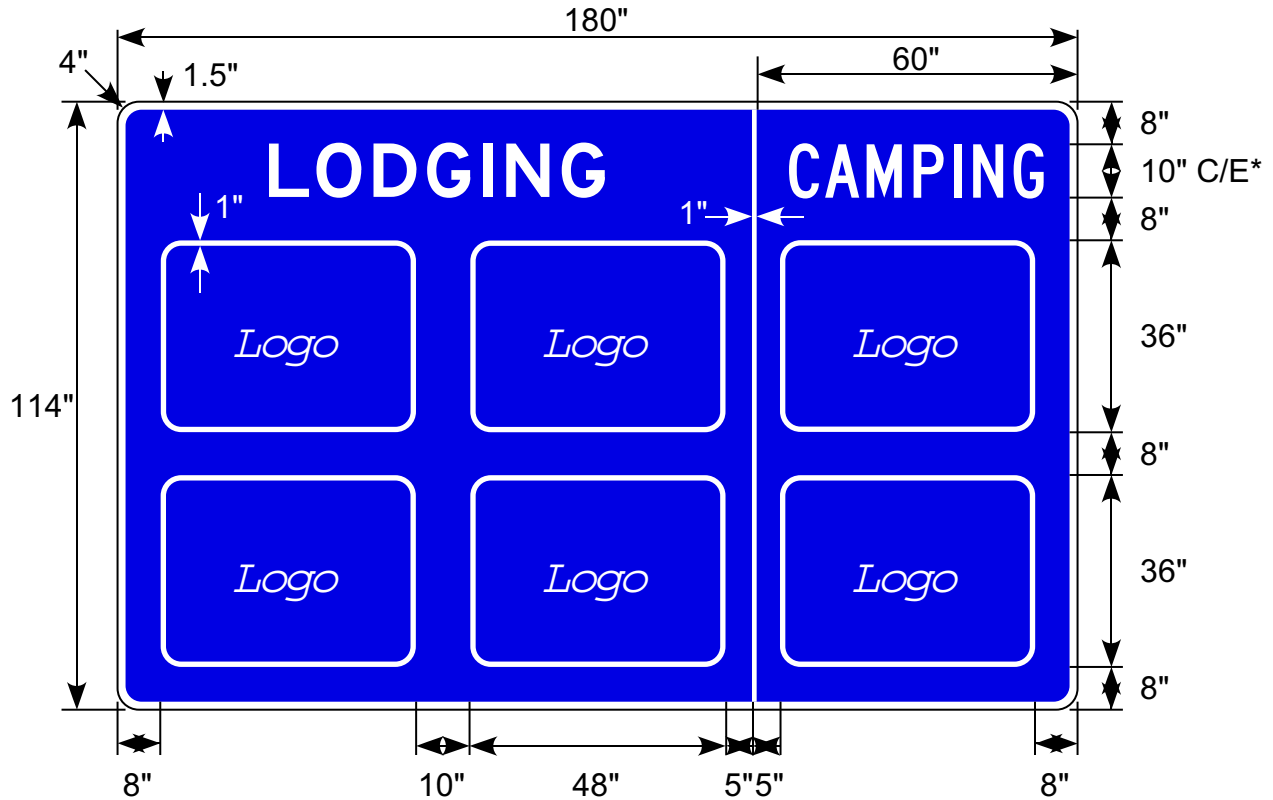

Border and Legend: White
Background: Blue

Alternative Headings:
CAMPING
FOOD
GAS
LODGING

* Use series E characters except for "CAMPING" OR "LODGING" when those words need to fit within a single column. In those cases, use series C.

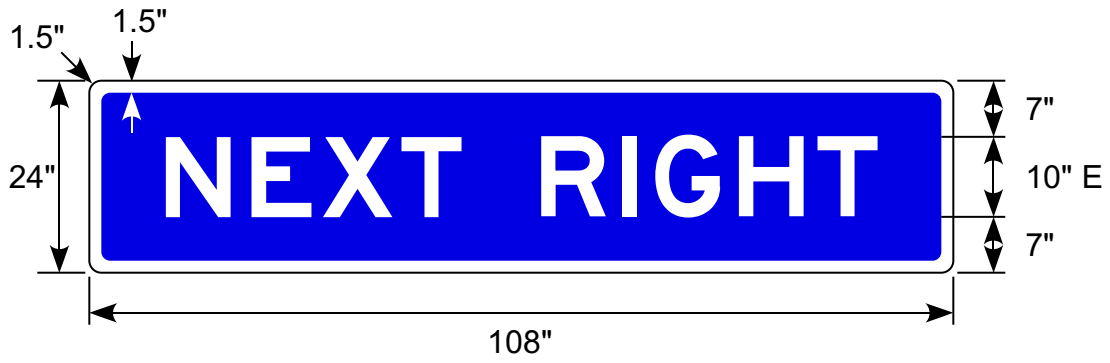

Border and Legend: White
Background: Blue

Intended to be used with 2 or 3 LG-F1x2 signs.

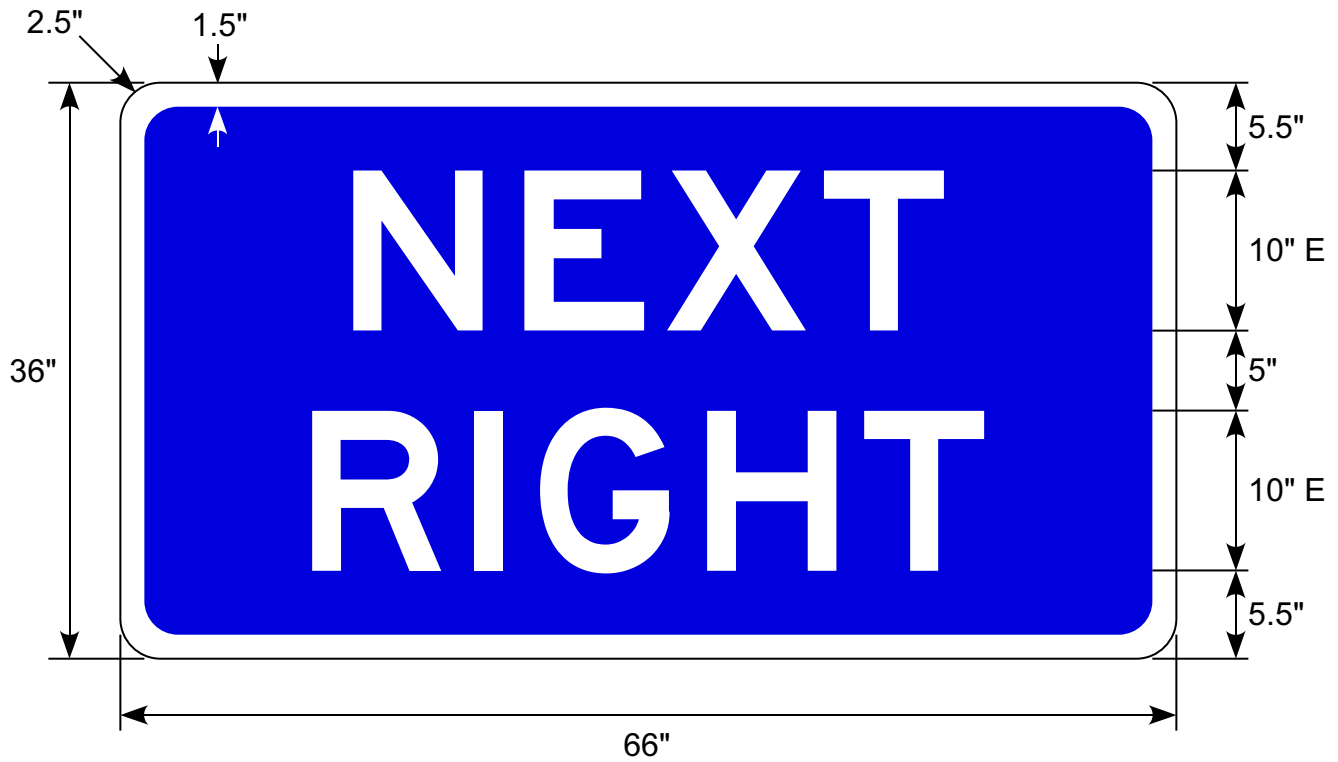

Border and Legend: White
Background: Blue

Intended to be used with one LG-F1x2 sign.

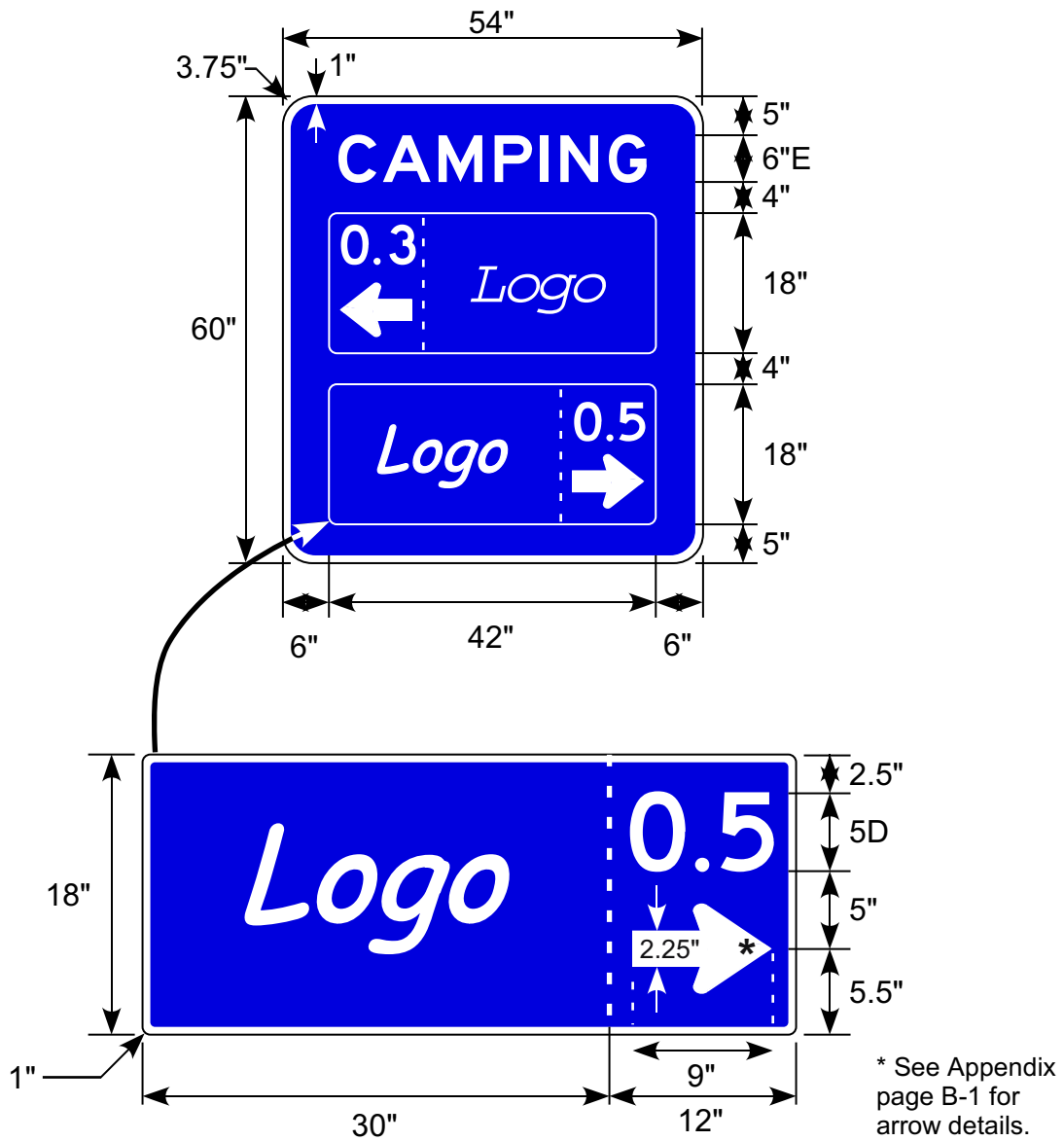

Border and Legend: White
Background: Blue

Alternative Headings:
CAMPING
FOOD
GAS
LODGING

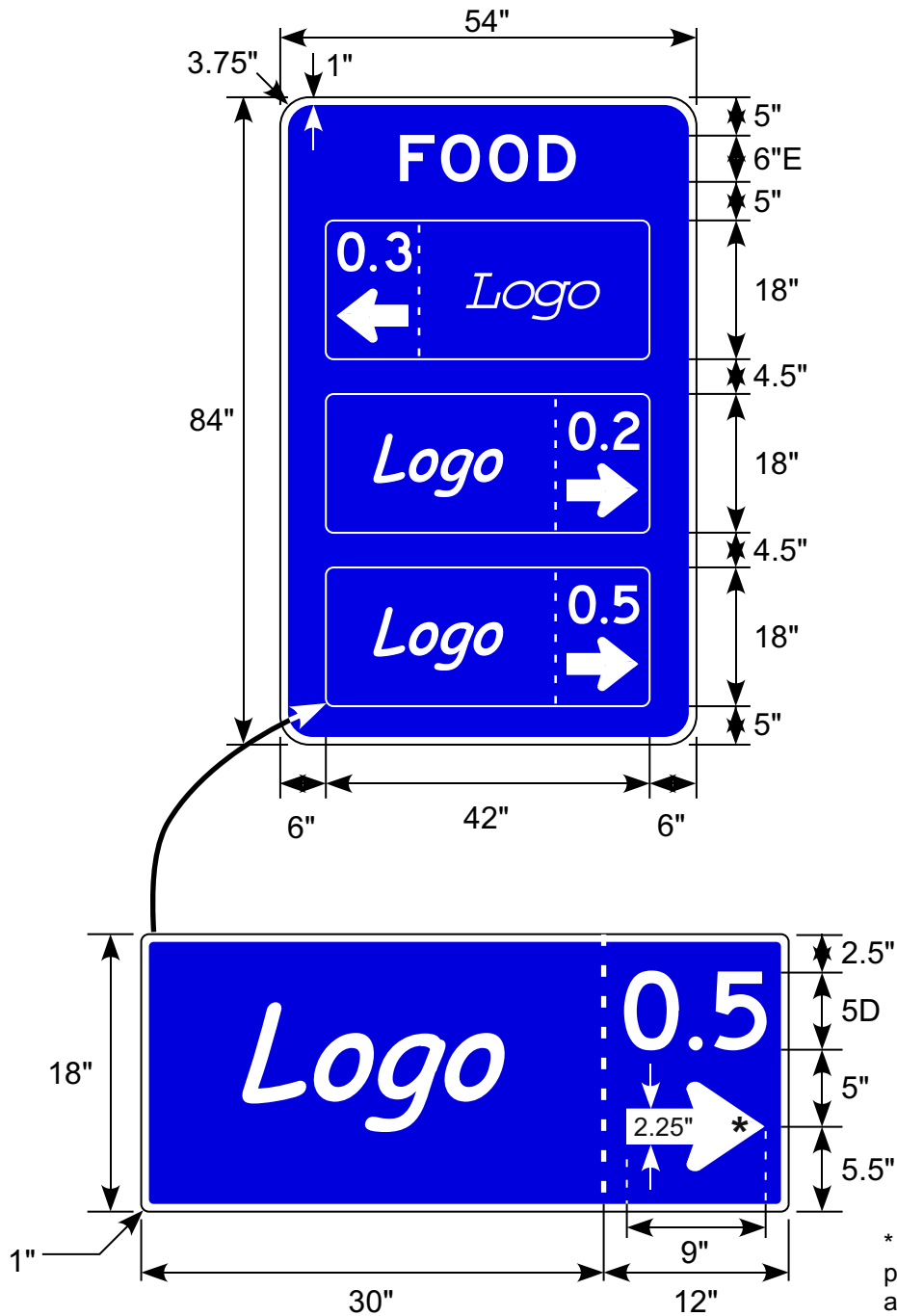

* See Appendix page B-1 for arrow details.

Border and Legend: White
Background: Blue

Alternative Headings:
CAMPING
FOOD
GAS
LODGING

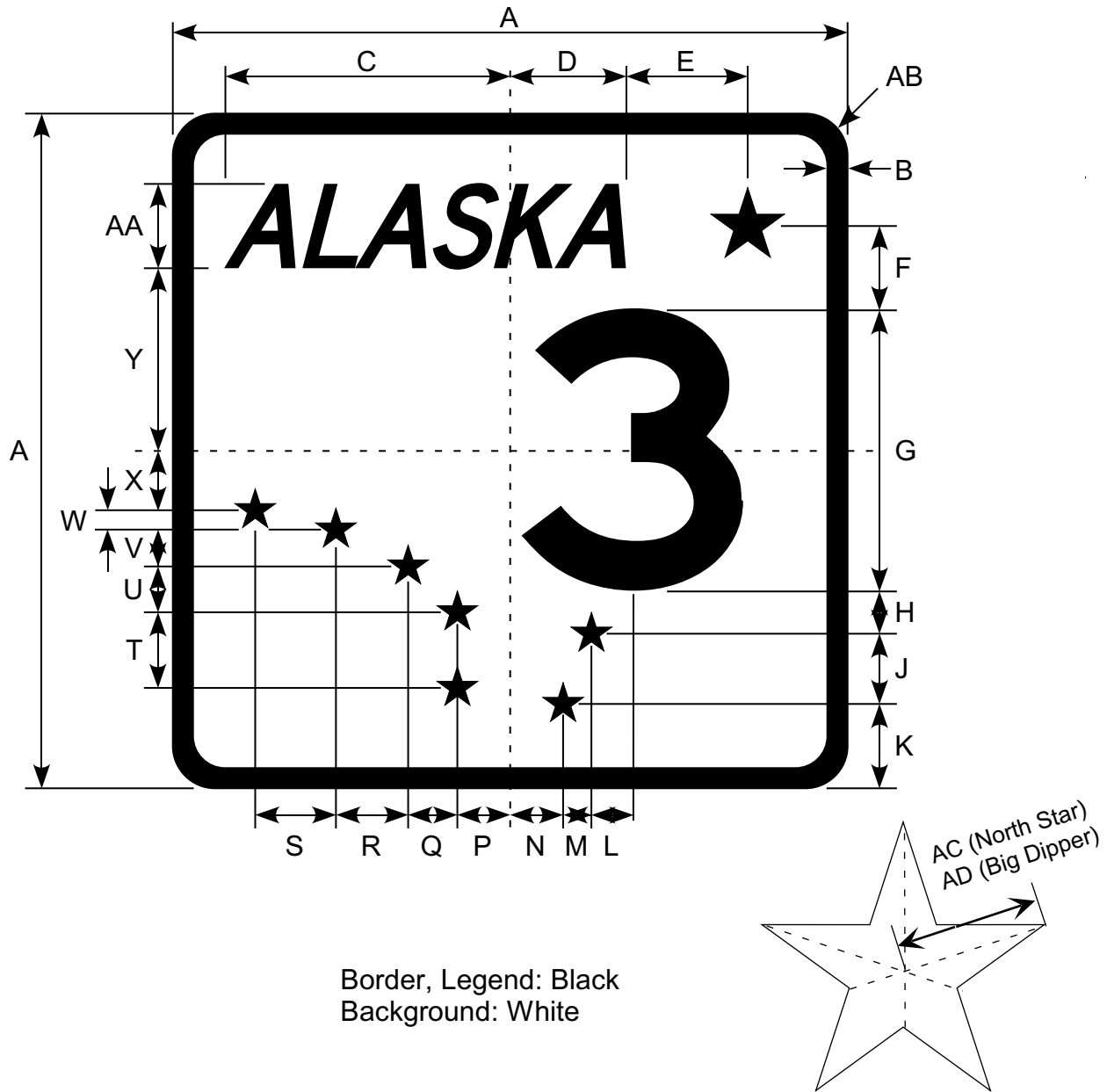

Border, Legend: Black
Background: White

Note: When used as an inset in a larger sign, this plate may be reduced to 18"x18" when design considerations necessitate minimizing sign size.

Road Class	Dimensions (inches)													
	A	B	C	D	E	F	G	H	J	K	L	M	N	P
Minimum	24	0.75	10.13	4.13	4.31	3	10E	1.5	2.50	3.0	1.50	1.0	1.88	1.88
Conventional	36	1.00	16.00	6.25	6.50	4	16E	1.75	3.75	4.5	2.25	1.5	2.81	2.81
	Q	R	S	T	U	V	W	X	Y	AA	AB	AC	AD	
	1.75	2.56	2.88	2.69	1.63	1.31	0.69	2.13	6.50	3.0	1.5	1.50	0.94	
	2.63	3.88	4.31	4.00	2.44	1.94	1.06	3.06	9.75	4.5	1.5	2.25	1.38	

M Series
MARKERS

ASDS SUPPLEMENT SIGNS

M1-5 to M12-100

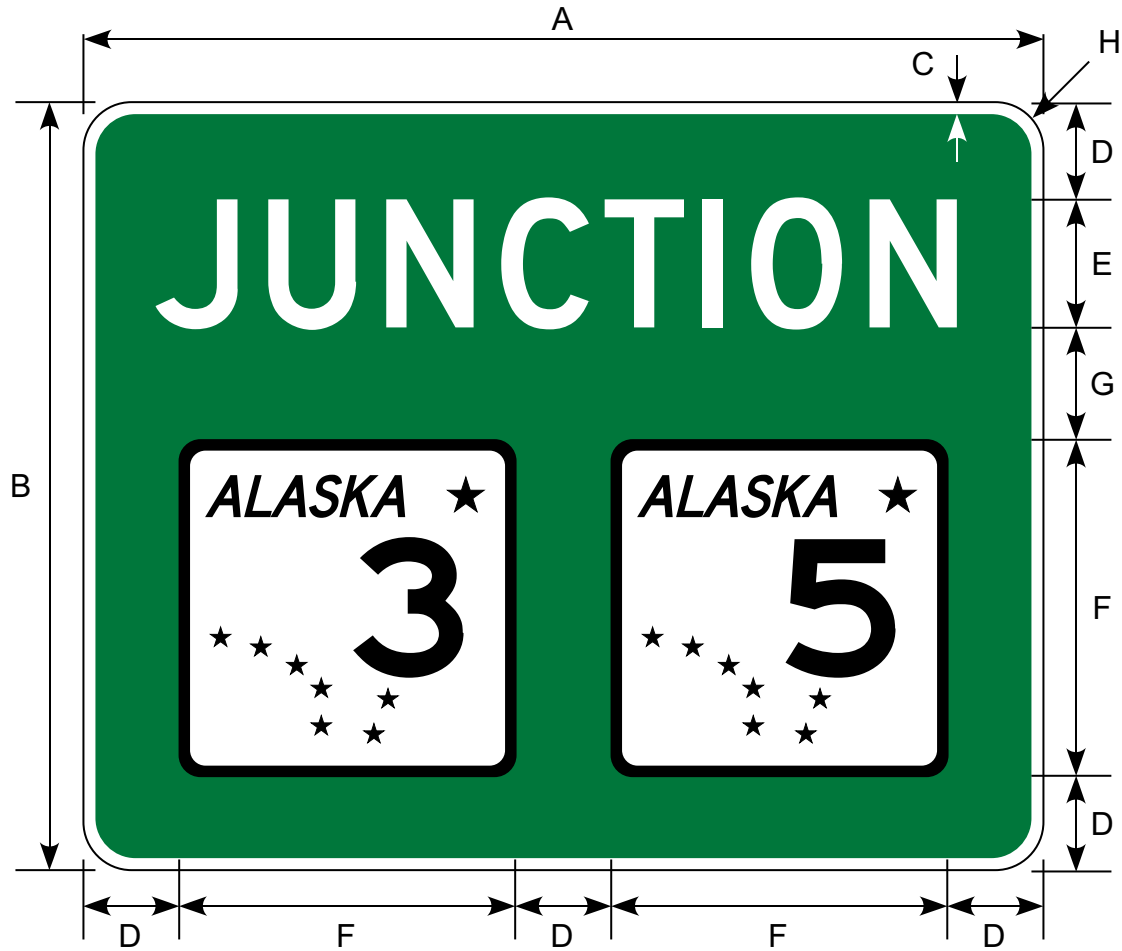

Legend: White
 Background: Green
 Route Plaque: Black on White

Make symbol proportional to the graphic shown.

Road Class	Dimensions (inches)							
	A	B	C	D	E	F	G	H
Expwy/Fwy	60	48	0.75	6.0	8D	21	7.0	3.00

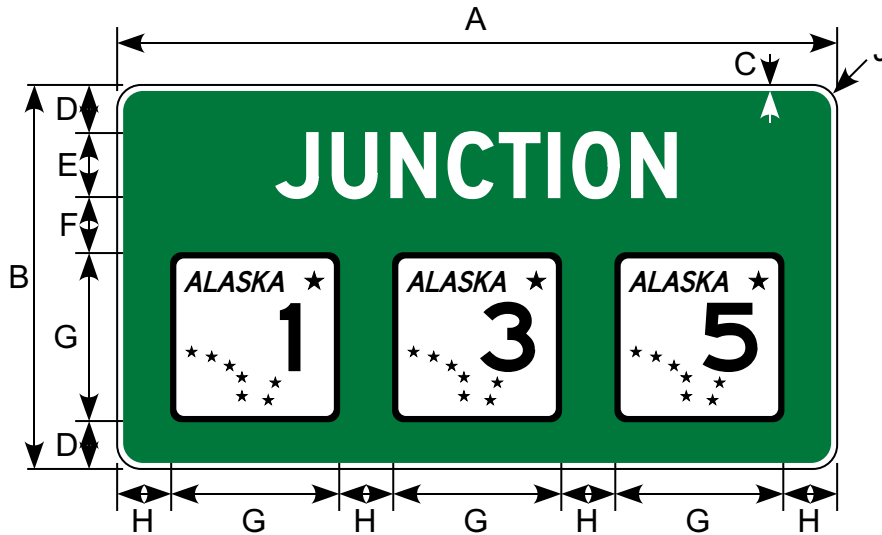

Legend: White
 Background: Green
 Route Plaque: Black on White

Make symbol proportional
 to graphic shown.

Road Class	Dimensions (inches)								
	A	B	C	D	E	F	G	H	J
Expwy/Fwy	90	48	0.75	6	8D	7	21	6.75	3.00

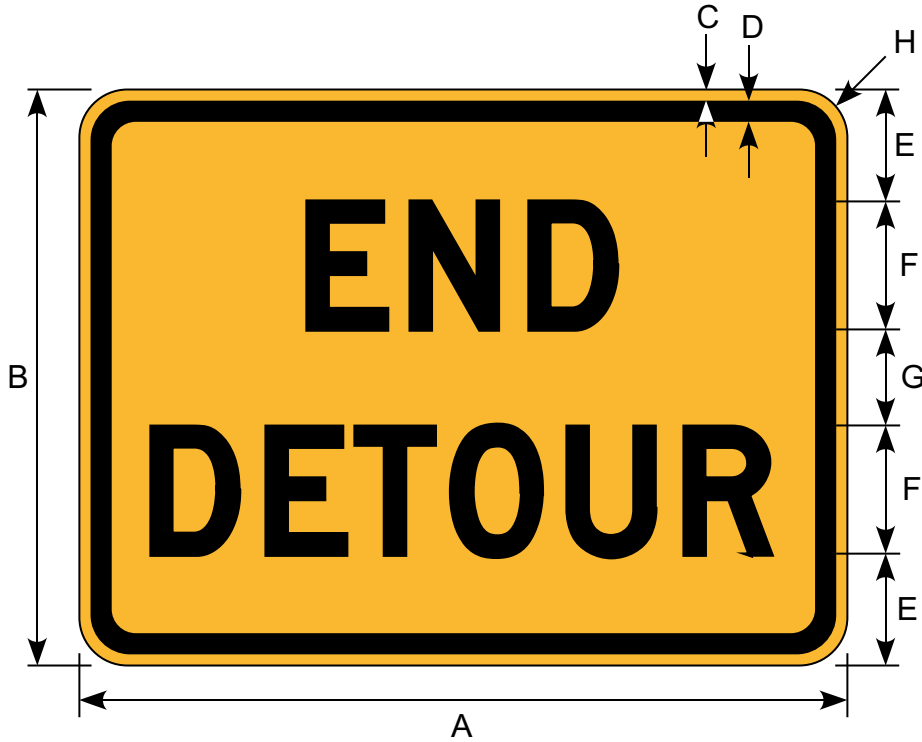

Border and Legend: Black
 Background: Orange

Road Class	Dimensions (inches)							
	A	B	C	D	E	F	G	H
Conv & Min	24	18	0.38	0.63	3.5	4D	3	1.5
Expwy/Fwy	30	24	0.63	0.88	4.5	6D	3	1.5

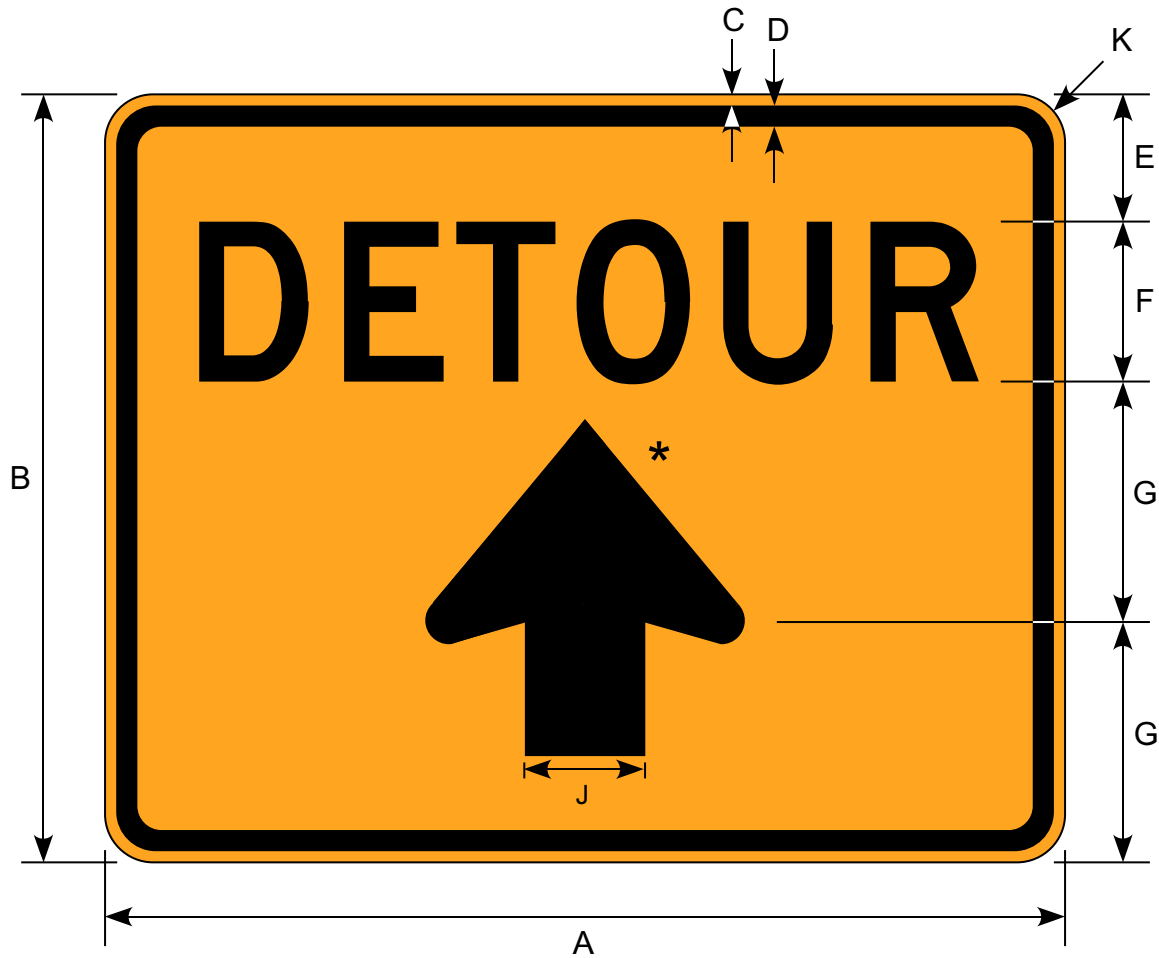

Border and Legend: Black
Background: Orange

* See Appendix B-1 for Standard Arrow Details.

Road Class	Dimensions (inches)								
	A	B	C	D	E	F	G	J	K
Conventional	30	24	0.38	0.63	4.0	5D	7.5	4.5	1.5
Expressway/ Freeway	48	36	0.63	0.88	6.0	8D	11	7.0	2.25
Oversized	60	48	0.75	1.25	8.0	10D	15	9.0	3.0

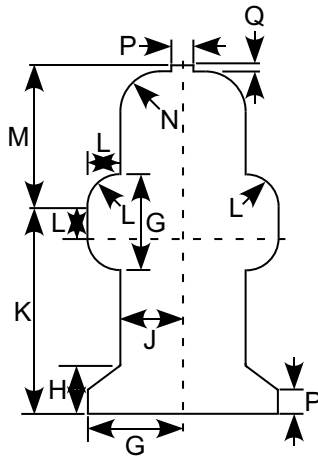
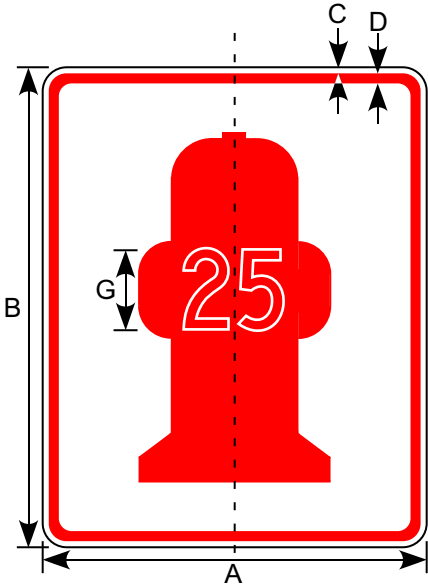

SYMBOL DETAILS

Border and Symbol: Red
 Background: White

Road Class	Dimensions (inches)														
	A	B	C	D	E	F	G	H	J	K	L	M	N	P	Q
Conv & Min	24	30	0.38	0.63	5C	1.5	6	3	4	13	2	9	2.5	1.5	0.5

R Series

REGULATORY SIGNS

ASDS SUPPLEMENT SIGNS

R2-100 to R16-118

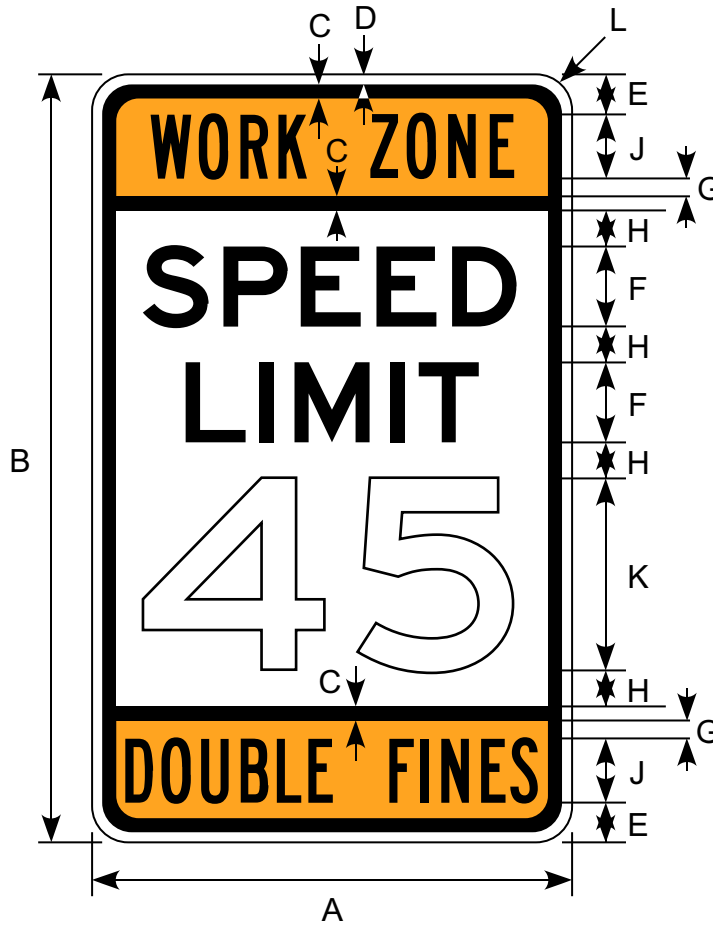

Border and Legend: Black
 Middle Background: White
 Upper & Lower Background: Orange

Road Class	Dimensions (inches)										
	A	B	C	D	E	F	G	H	J	K	L
Conv & Min	30	48	0.88	0.63	2.50	5E	1.12	2.25	4B	12E	2.25

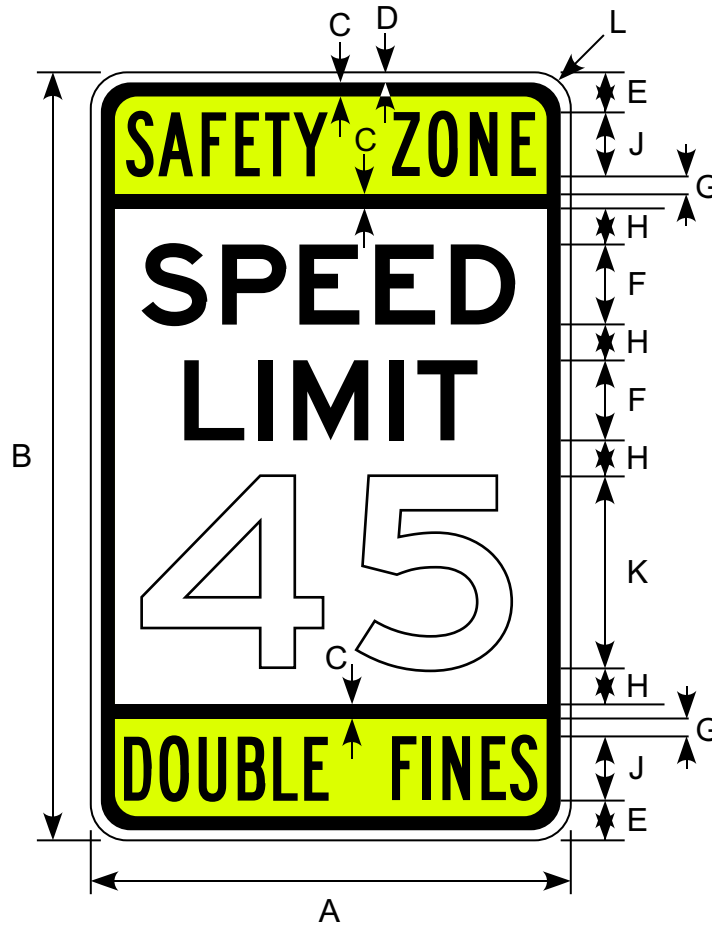

Border and Legend: Black
 Middle Background: White
 Upper & Lower Background: Fluorescent Yellow

Road Class	Dimensions (inches)										
	A	B	C	D	E	F	G	H	J	K	L
Conv & Min	30	48	0.88	0.63	2.50	5E	1.12	2.25	4B	12E	2.25



Border and Legend: Black
 Background: White

Plaque associated with R3-4,
 - With Expressway/Freeway crossovers

Road Class	Dimensions (inches)							
	A	B	C	D	E	F	H	J
Expy/Frwy	36	12	0.38	0.63	2.0	3B	3C	2.25

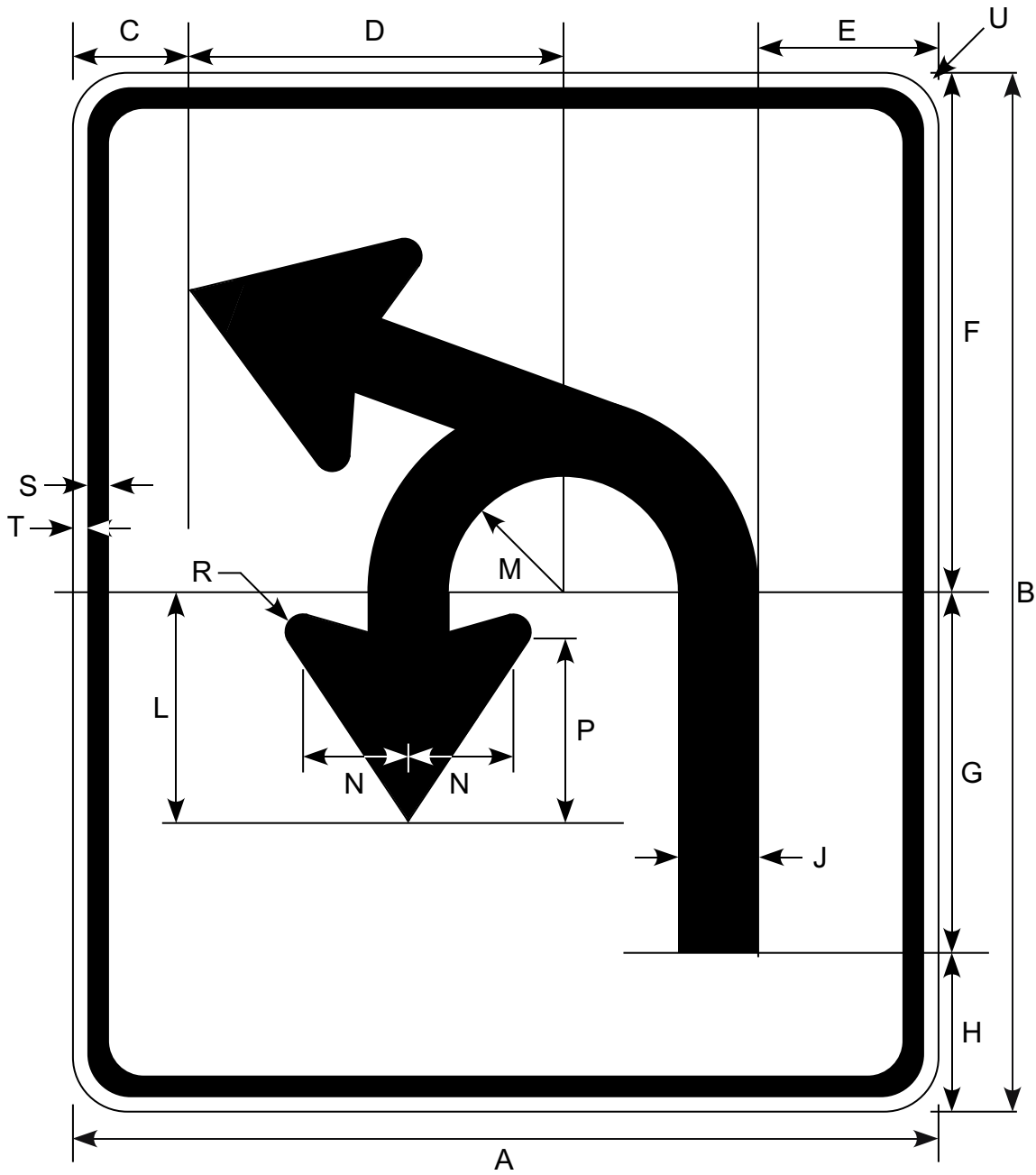

Border and Legend: Black
Background: White

*See Appendix B-1 for Standard Arrow Details.







Road Class	Dimensions (inches)									
	A	B	C	D	E	F	G	H	J	L
Std & Conv	30	36	4.0	13	6.25	18	12.5	5.5	2.75	8.0
	M	N	P	R	S	T	U			
	4	3.64	6.38	0.63	0.75	0.50	1.88			

Advance Intersection Lane Control Signs

Multiple lane use control signs (collectively R3-108 signs) may be specified with legends other than those illustrated on the following pages.

All R3-108 signs shall have black legends on white backgrounds.

Movements may be signified with the following suffixes:

Movement:							
	ONLY	ONLY	ONLY				
Suffix:	L	S	R	SL	SR	LR	UL

For example, a sign indicating a restricted left turn lane, a left or through center lane, and a restricted right turn lane would appear as follows:

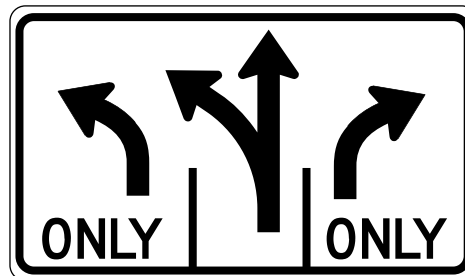

R3-8L/SL/R

For roundabout lane control signs reference 2012 SHS Supplement R3-8.

See MUTCD for Intersection Lane Control Signs.

For additional information on roundabout signing, see MUTCD examples of roundabout signing.

R3-108A

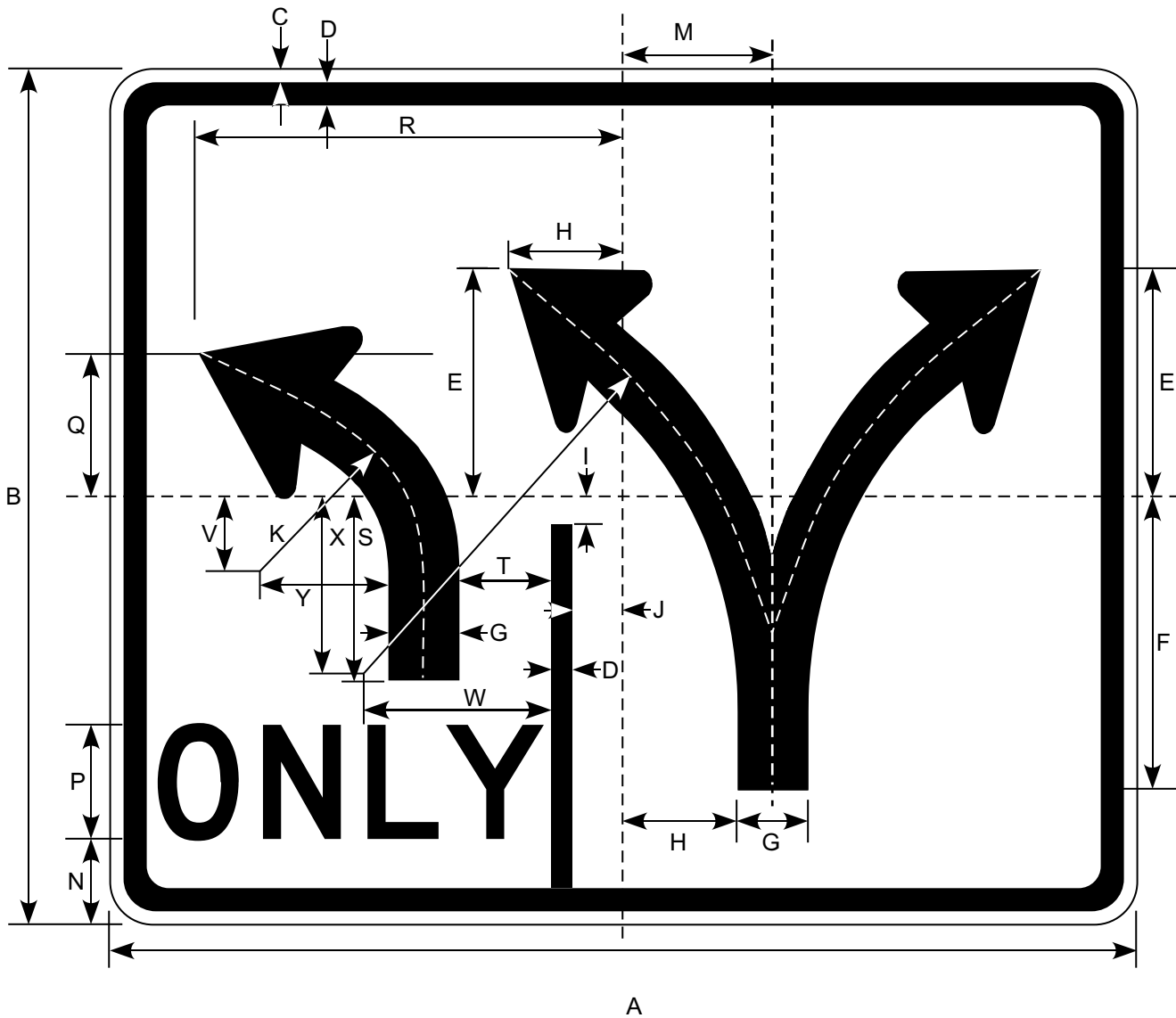

Border and Legend: Black
Background: White

*See Appendix B-1 for Standard Arrow Details.

Road Class	Dimensions (inches)												
	A	B	C	D	E	F	G	H	J	K	L	M	N
Conv&Min	36	30	0.5	0.75	8.0	10.25	2.5	4.0	1.75	5.75	1.0	5.25	3.0
	P	Q	R	S	T	V	W	X	Y	Z			
	4D	5.0	15	6.5	3.25	2.63	6.60	6.21	4.5	14.0			

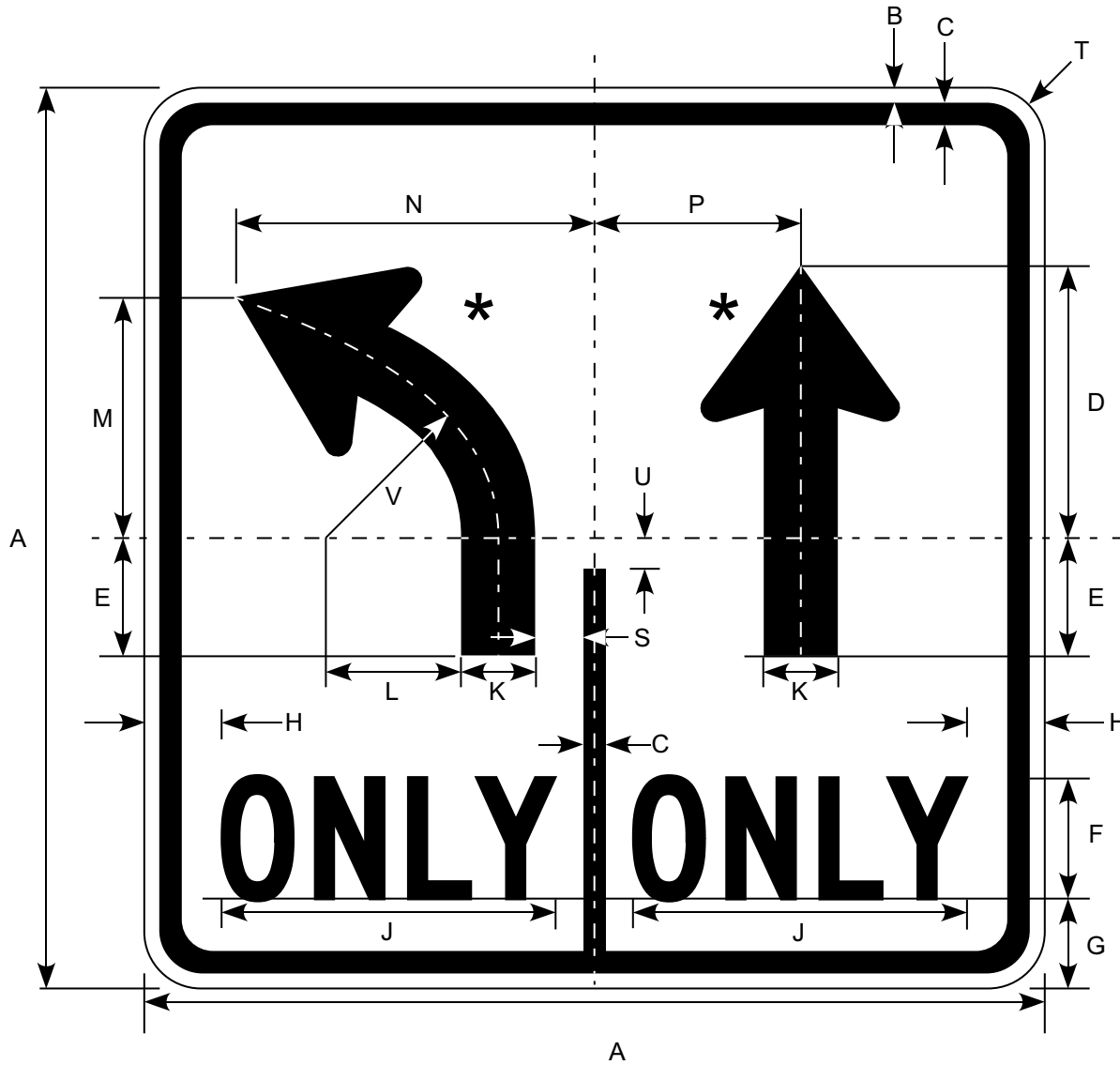

Border and Legend: Black
Background: White

*See Appendix B-1 for Standard Arrow Details.

Road Class	Dimensions (inches)																	
	A	B	C	D	E	F	G	H	J	K	L	M	N	P	S	T	U	V
Conv&Min	30	0.5	0.75	9.06	3.94	4C	3.0	2.56	11.13	2.50	4.50	8.0	11.94	6.88	1.56	1.88	1.0	5.75

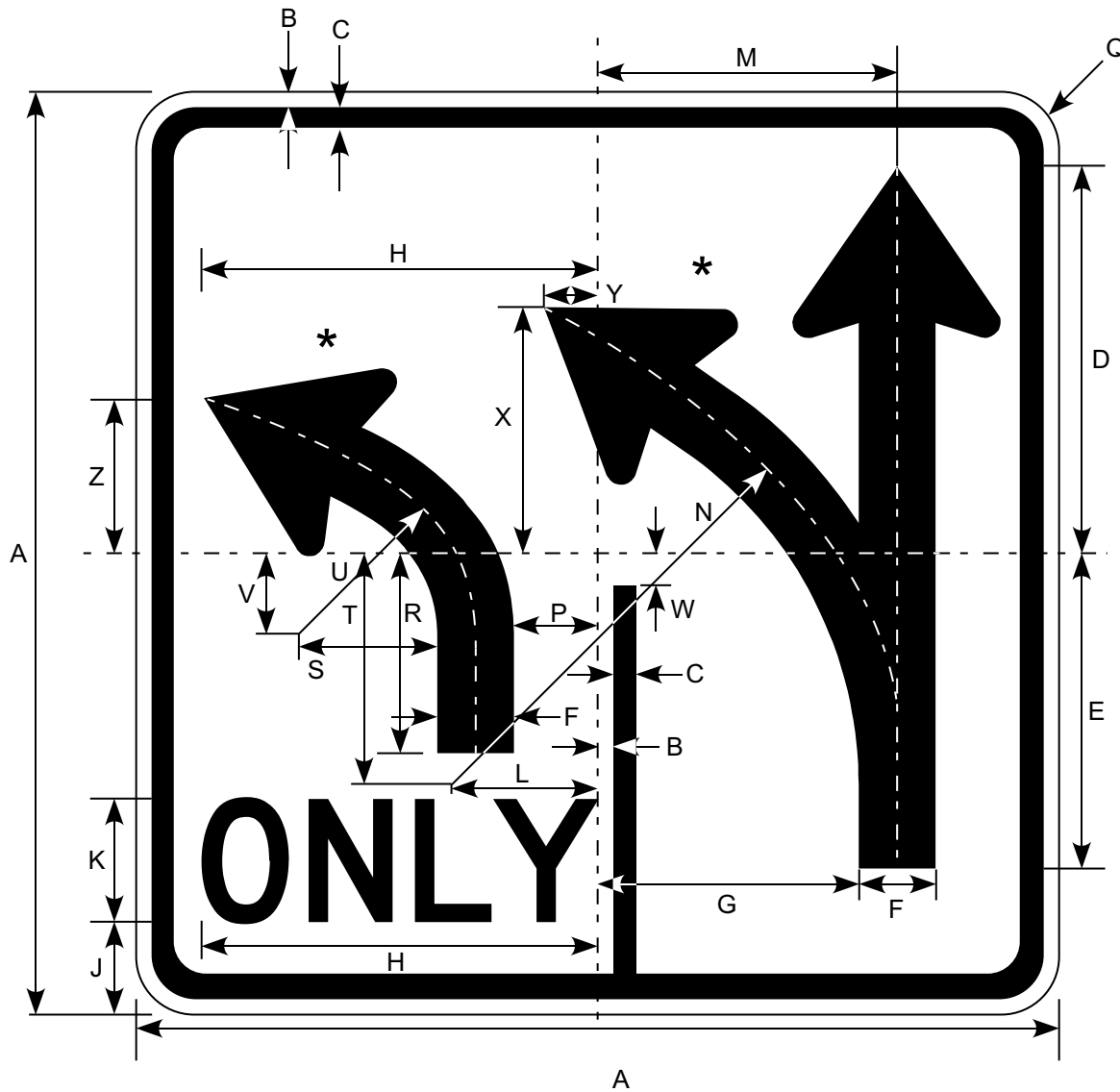

Border and Legend: Black
Background: White

*See Appendix B-1 for Standard Arrow Details.

Road Class	Dimensions (inches)																	
	A	B	C	D	E	F	G	H	J	K	L	M	N	P	Q	R	S	T
Conv&Min	30	0.50	0.75	12.6	10.25	2.5	8.50	12.88	3.0	4D	4.75	9.75	14.5	2.75	1.9	6.50	4.50	7.5
Expwy	48	0.75	1.25	20.0	16.38	4.0	13.6	20.63	5.0	6D	7.63	15.63	23.3	4.38	3.0	10.38	7.19	12.0

U	V	W	X	Y	Z
5.75	2.63	1.00	8.00	1.75	5.0
9.25	4.25	1.63	12.75	2.75	8.0

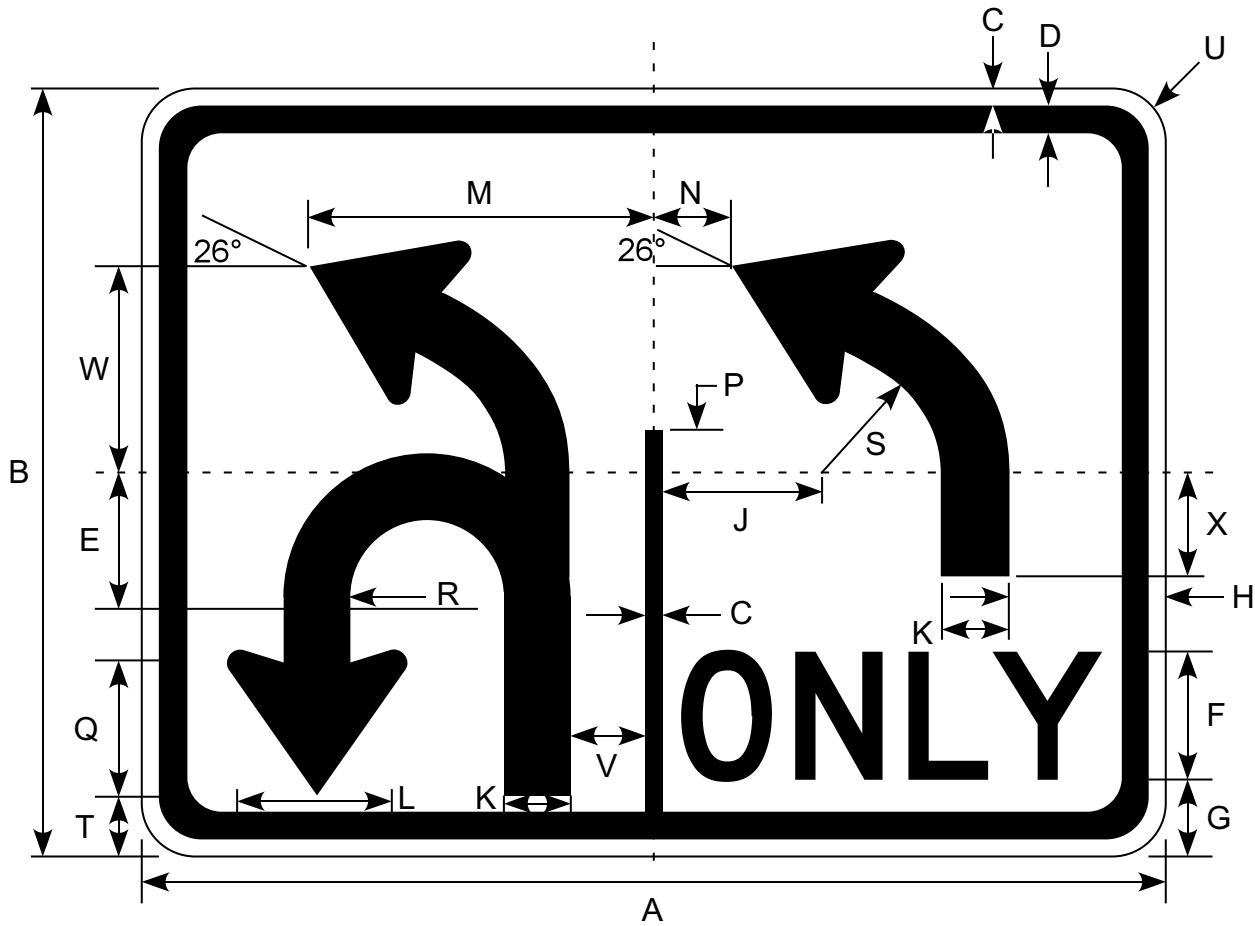

Border and Legend: Black
Background: White

*See Appendix B-1 for Standard Arrow Details.

Road Class	Dimensions (inches)										
	A	B	C	D	E	F	G	H	J	K	L
Conventional	48	36	0.8	1.3	6.4	6D	3.6	7.32	7.51	3.13	7.25
	M	N	P	Q	R	S	T	U	V	W	X
	16.22	3.6	2.0	6.38	3.6	5.63	2.81	2.5	3.54	9.67	4.85

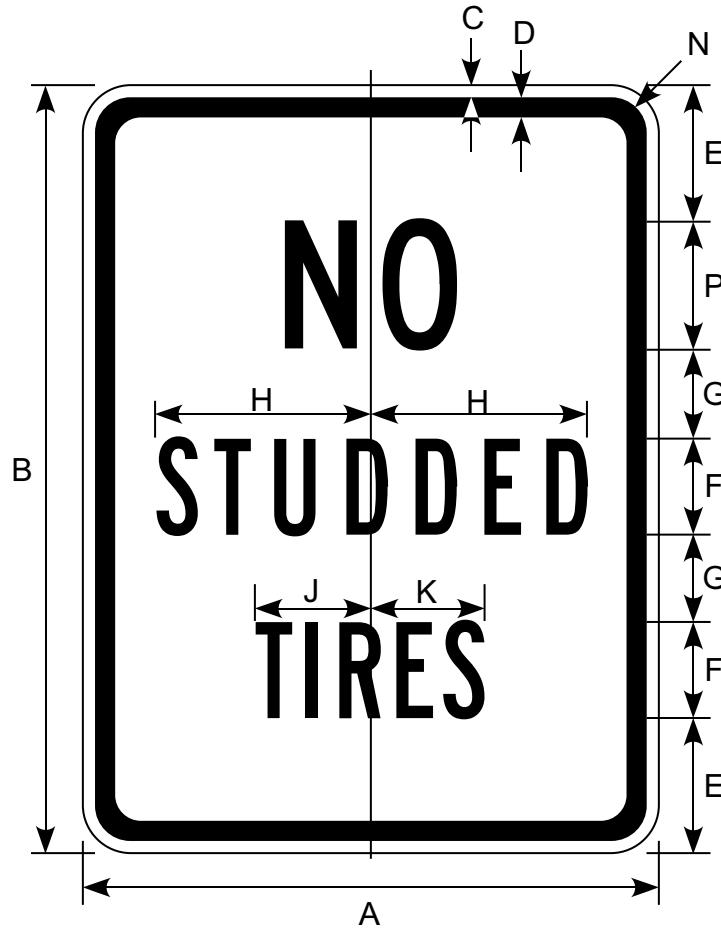

Border and Legend: Black
Background: White

Road Class	Dimensions (inches)											
	A	B	C	D	E	F	G	H	J	K	N	P
Minimum	18	24	0.38	0.63	4.25	3B	2.75	6.75	3.63	3.56	1.50	4C
Conventional	24	30	0.38	0.63	5.0	4B	3.5	7.75	4.88	4.75	1.5	5C
Expressway	36	48	0.63	0.88	8.5	6B	5.5	11.63	7.31	7.13	2.25	8C
Freeway	48	60	0.75	1.25	10	8B	7.0	15.5	9.75	9.5	3	10C

R5-103
R5-103P

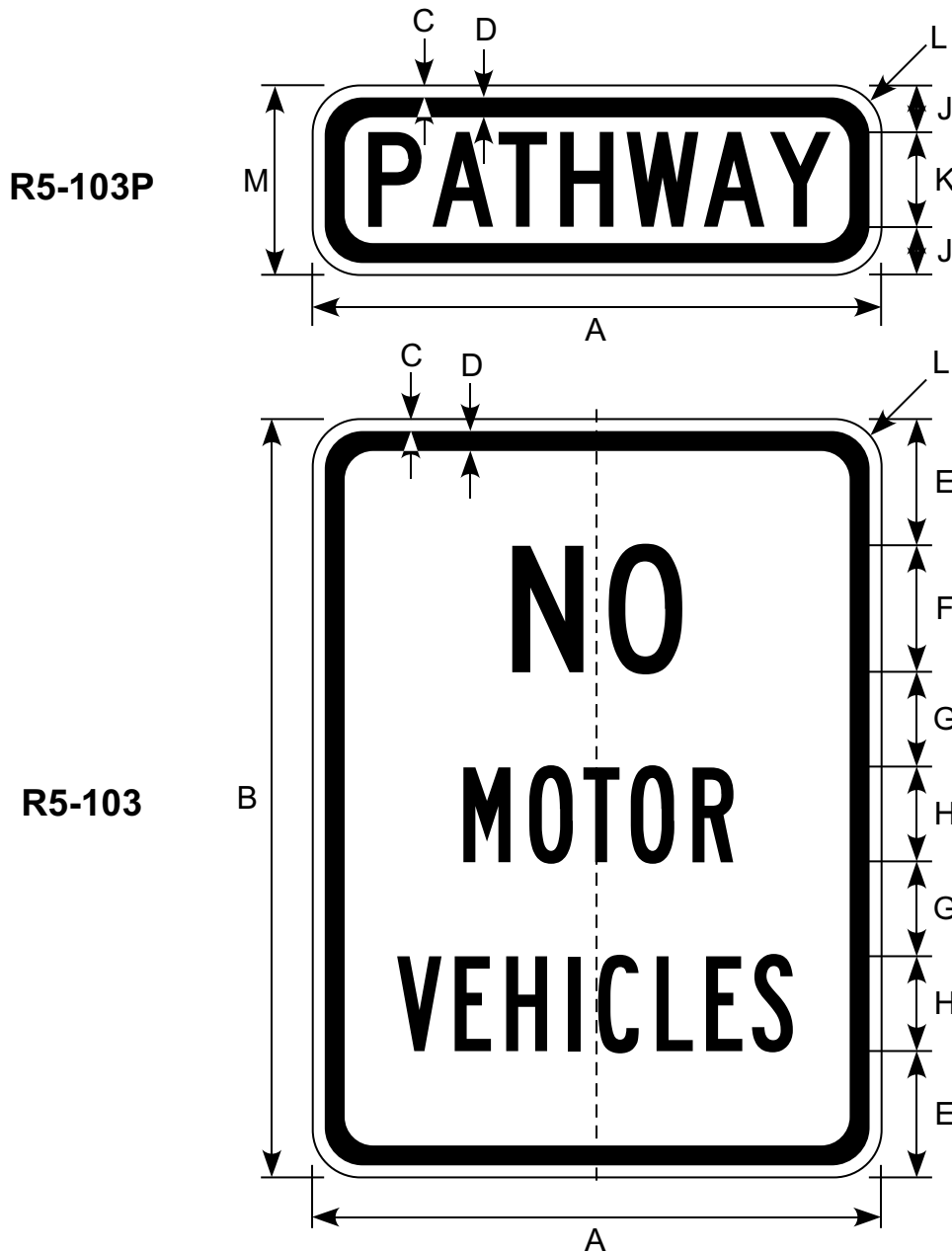

Border and Legend: Black
 Background: White

Road Class	Dimensions (inches)											
	A	B	C	D	E	F	G	H	J	K	L	M
Minimum	12	18	0.38	0.63	3.0	3C	2.5	2B	2.0	2B	1.5	6.0
Conventional	18	24	0.38	0.63	4.0	4C	3.0	3B	1.5	3C	1.5	6.0

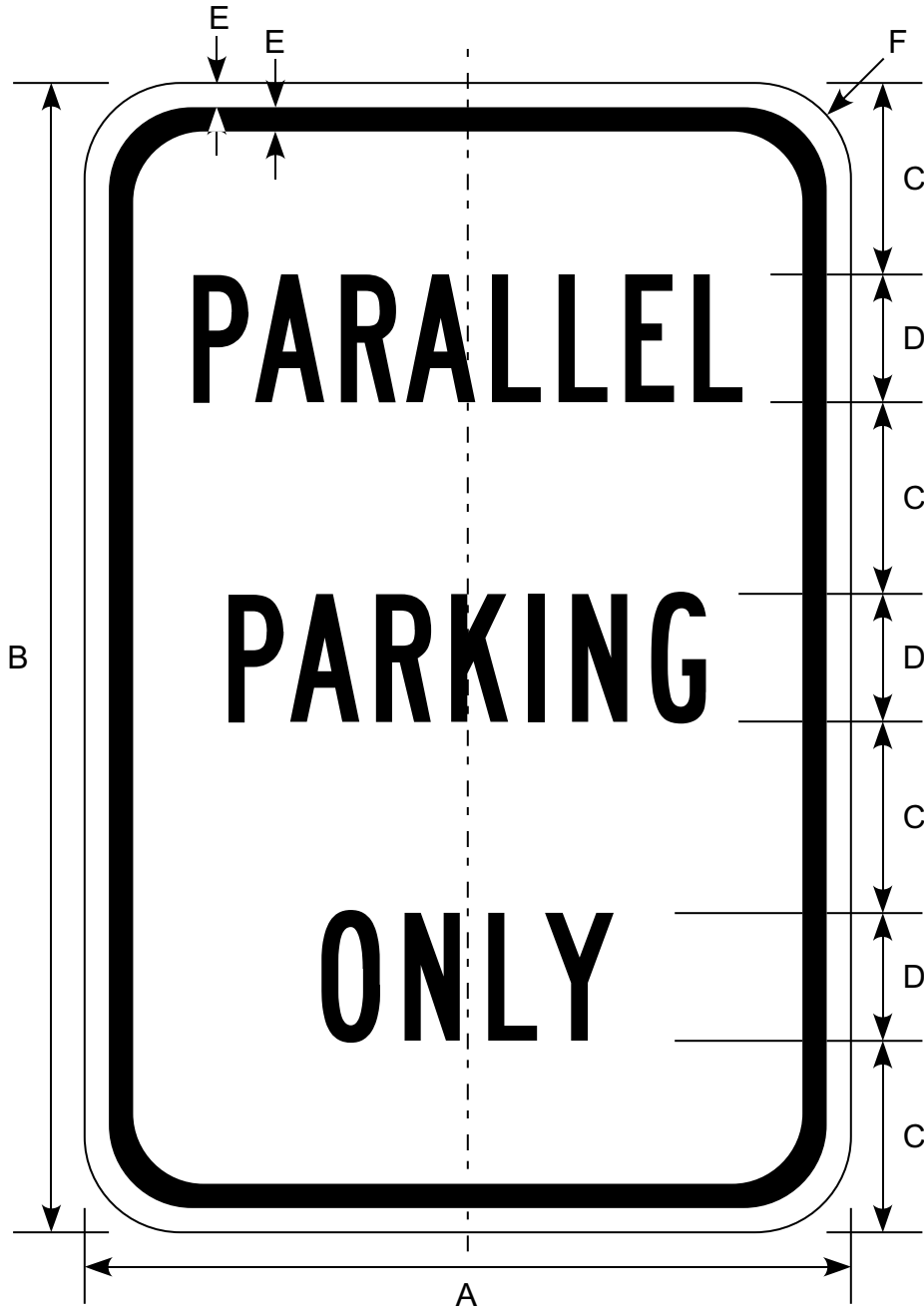

Border and Legend: Black
Background: White

Road Class	Dimensions (inches)					
	A	B	C	D	E	F
Conv & Min	12	18	3	2B	0.38	1.5

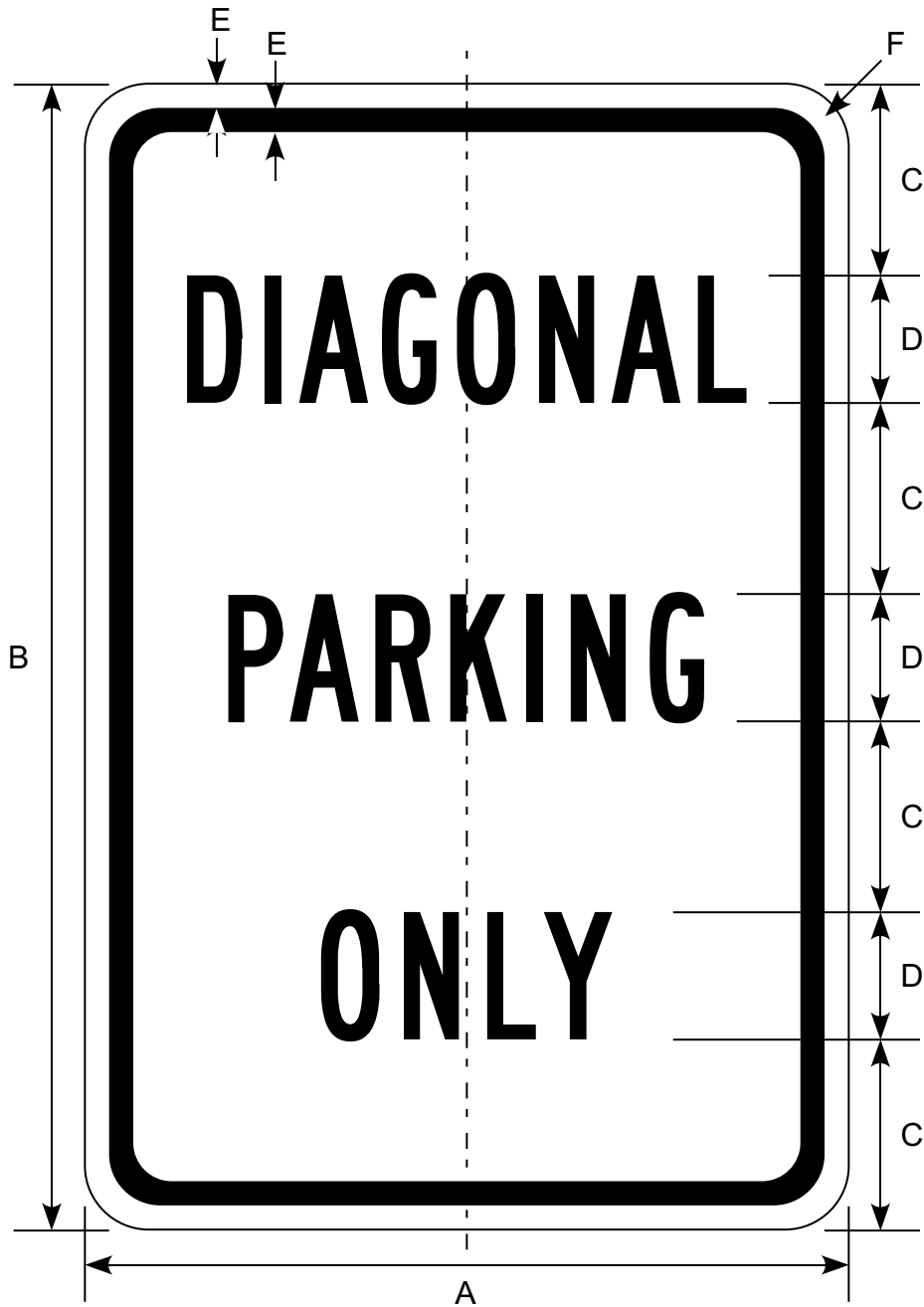

Border and Legend: Black
Background: White

Road Class	Dimensions (inches)					
	A	B	C	D	E	F
Conv & Min	12	18	3	2B	0.38	1.0

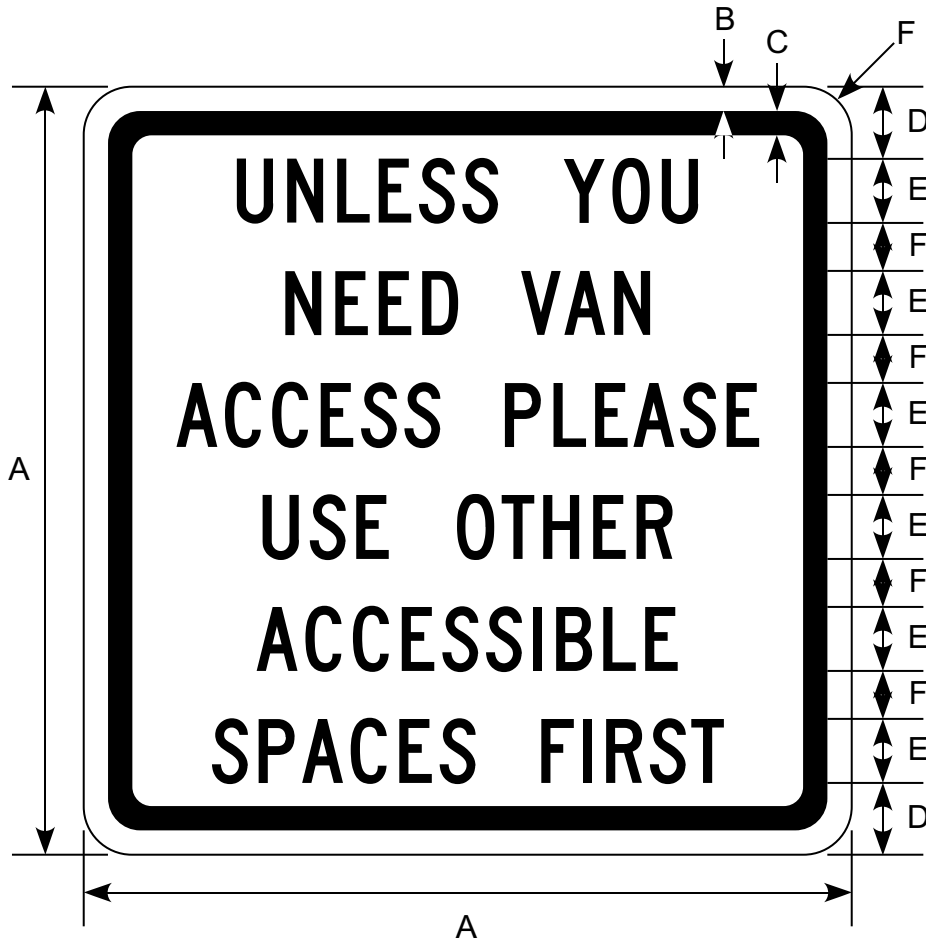

Border and Legend: Black
 Background: White

Road Class	Dimensions (inches)					
	A	B	C	D	E	F
Conv & Min	12	0.38	0.38	1.13	1.0C	0.75

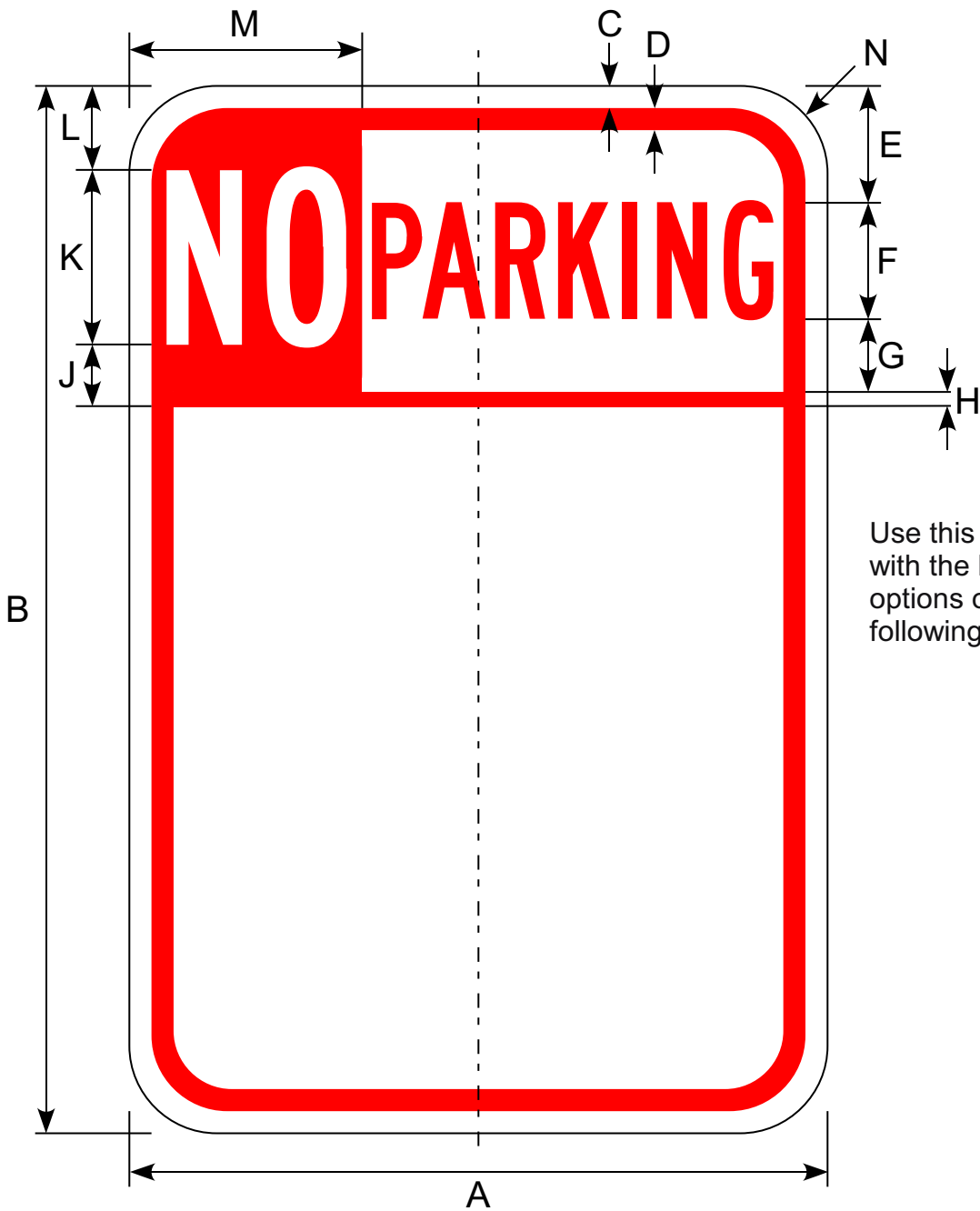

Use this template with the legend options on the following pages

Top Left
 Legend: White
 Background: Red

Top Right & Bottom
 Legend: Red
 Background: White

Road Class	Dimensions (inches)												
	A	B	C	D	E	F	G	H	J	K	L	M	N
Conv & Min	12	18	0.38	0.38	2	2B	1.25	0.25	1.06	3B	1.44	4	1.5

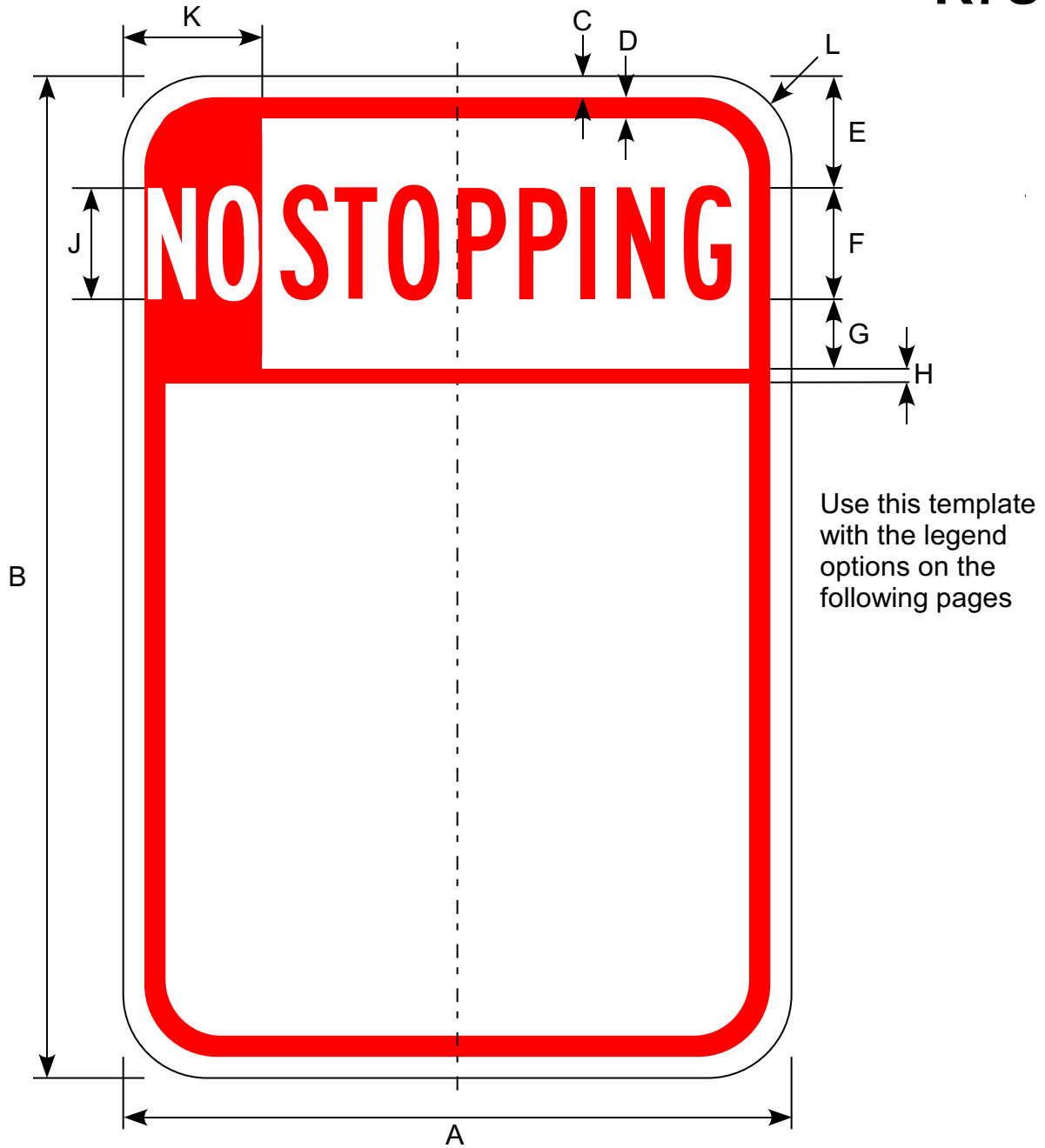

Top Left
 Legend: White
 Background: Red

Top Right & Bottom
 Legend: Red
 Background: White

Road Class	Dimensions (inches)										
	A	B	C	D	E	F	G	H	J	K	L
Conv & Min	12	18	0.38	0.38	2	2B	1.25	0.25	2B	2.5	1.5

Legend Options for R7S & R7P

(1 of 4)

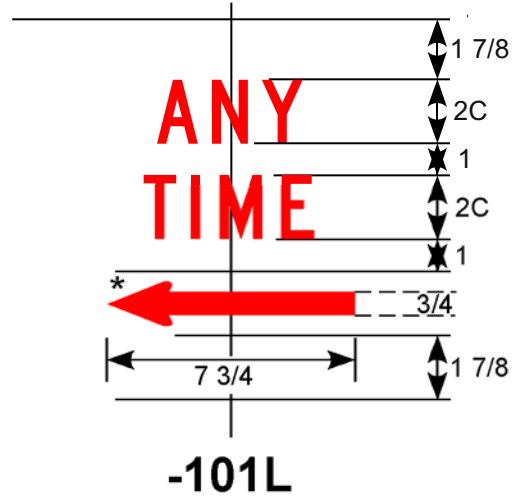
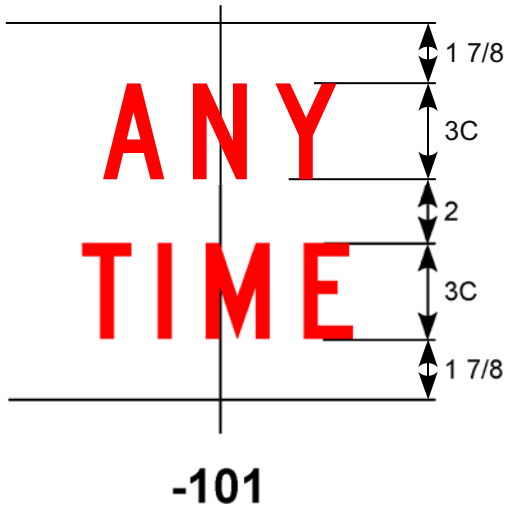

Reverse arrow for -101R

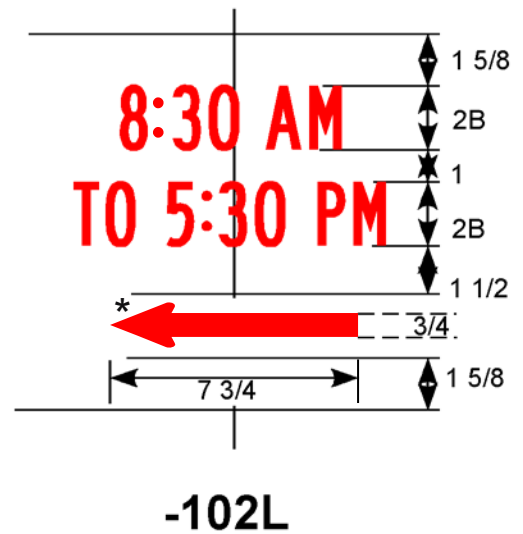
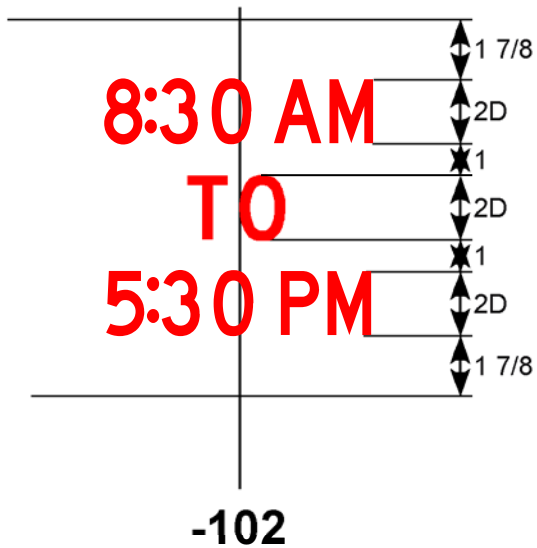

Reverse arrow for -101L

Legend: Red
Background: White

* See Appendix B-1 for arrow details.

Legend Options for R7S & R7P

(2 of 4)

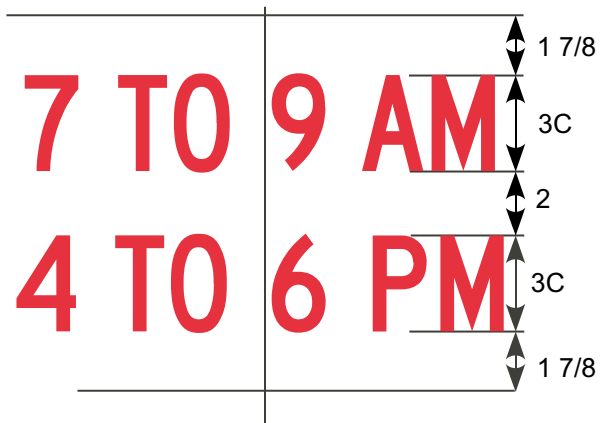

-102A

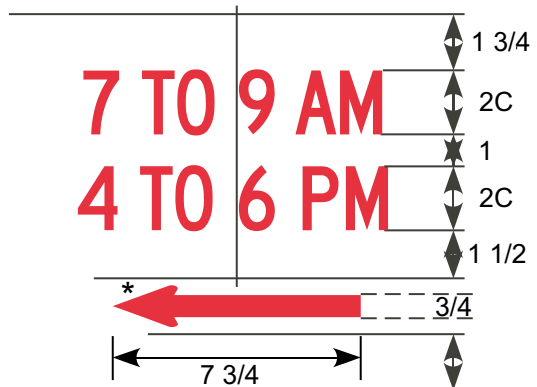

-102AL

Reverse arrow for -102AR

Legend: Red
Background: White

* See Appendix B-1 for standard arrow details.



-103

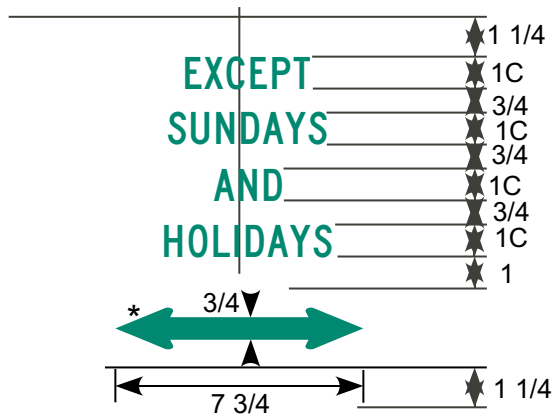

-103RL

Legend: Green
Background: White

* See Appendix B-1 for standard arrow details.

Legend Options for R7S & R7P

(3 of 4)

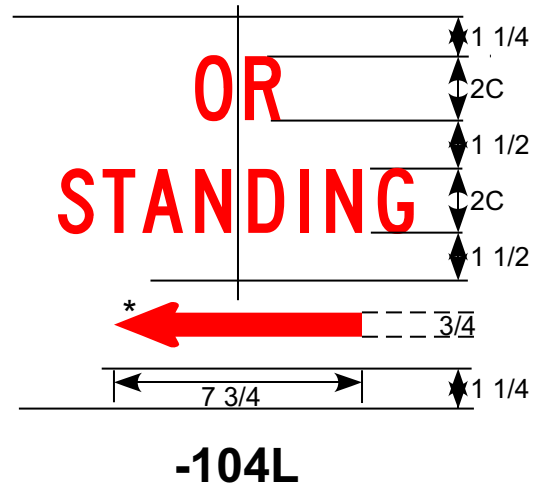
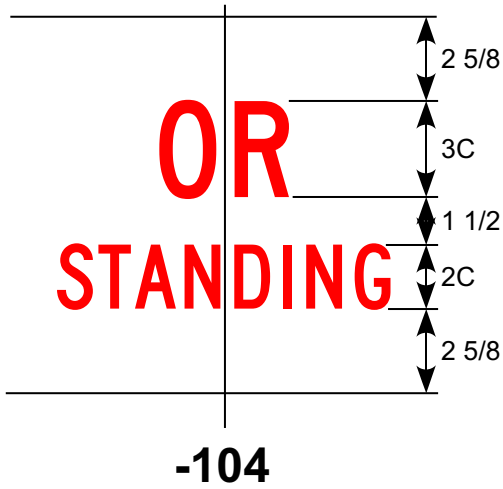

Reverse arrow for -104R

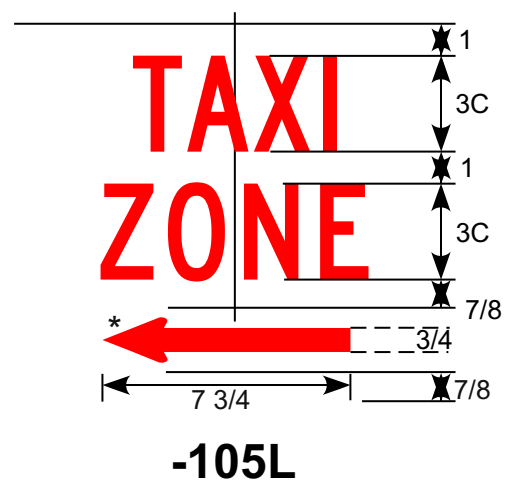
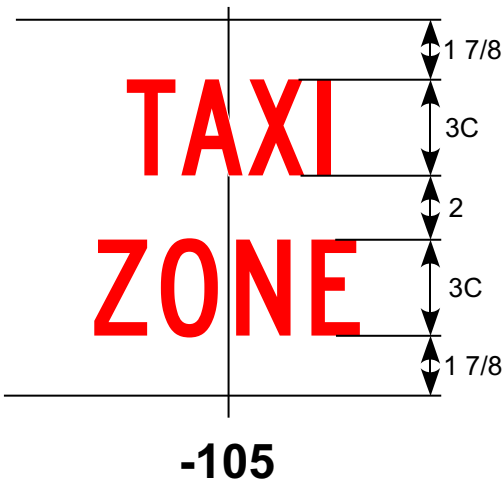

Reverse arrow for -105R

Legend: Red
Background: White

* See Appendix B-1 for arrow details.

Legend Options for R7S & R7P

(4 of 4)

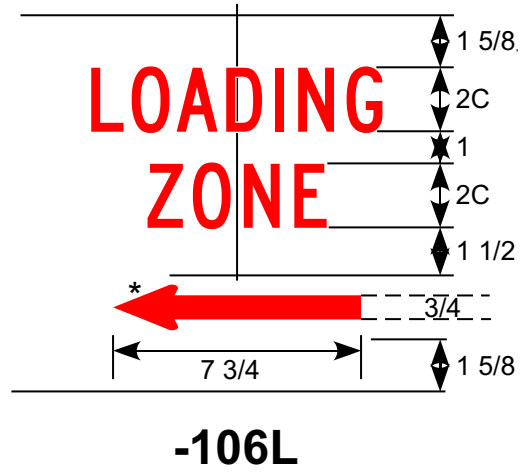
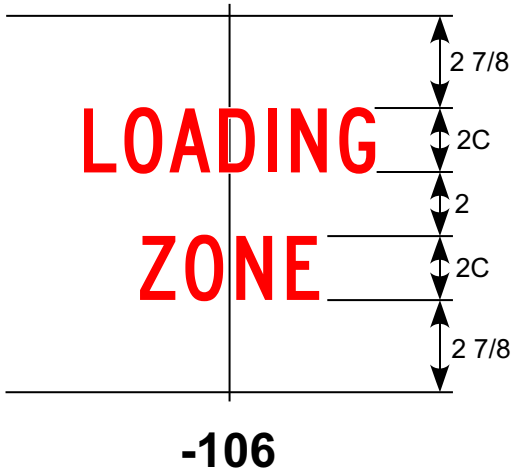

Reverse arrow for -106R

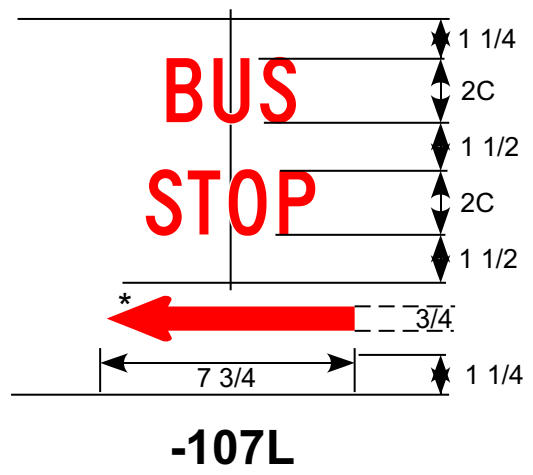
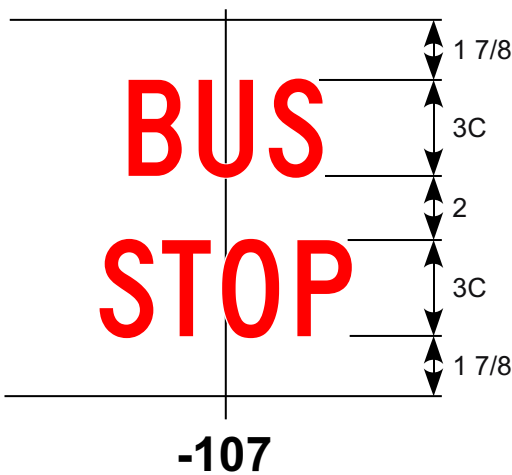

Reverse arrow for -107R

Legend: Red
Background: White

* See Appendix B-1 for arrow details.



Border and Legend: Red
Background: White

Road Class	Dimensions (inches)									
	A	B	C	D	E	F	G	H	J	K
Conv & Min	24	12	0.38	0.38	10.5	1.5	4C	1	7.5	0.75



Border and Legend: Red
Background: White

Road Class	Dimensions (inches)											
	A	B	C	D	E	F	G	H	J	K	L	M
Conv & Min	30	36	0.38	0.63	4.6	7D	2.75	6C	4C	2.25	2.65	1.5



Border and Legend: Green
Background: White

Road Class	Dimensions (inches)							
	A	B	C	D	E	F	G	H
Conv & Min	18	24	0.38	0.63	4C	4B	3	1.5

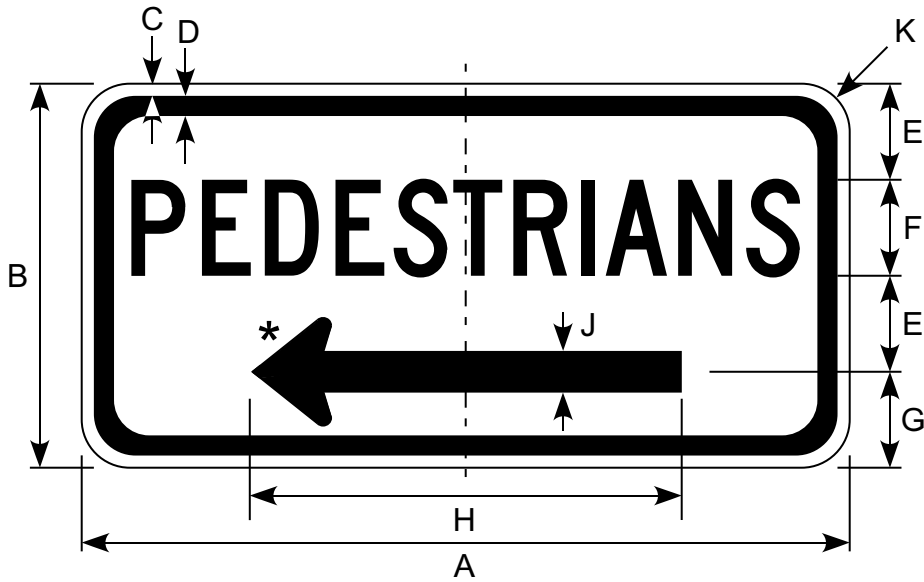

Border and Legend: Black
Background: White

*See Appendix B-1 for Standard Arrow Details.

Road Class	Dimensions (inches)									
	A	B	C	D	E	F	G	H	J	K
Conv & Min	24	12	0.38	0.63	3	3C	3	13.5	1.3	1.5



Border and Legend: Black
 Background: White

* Make Symbols proportional to sign drawing.

Road Class	Dimensions (inches)									
	A	B	C	D	E	F	G	H	J	
Conv & Min	24	24	0.38	0.63	4	3D	8	5	1.5	

R10-100



Border and Legend: Black
 Ball: Green
 Background: White

* See R3-5L for arrow details

** Make symbol proportional to the one shown.

Road Class	Dimensions (inches)																			
	A	B	C	D	E	F	G	H	J	K	L	M	N	P	Q	R	S	T	U	V
Conv & Mir	30	36	0.5	0.75	3	1.75	3.25	1.5	8	2.25	3.75	2	19	2.75	3D	1.5	0.5	2.75	6C	1.88

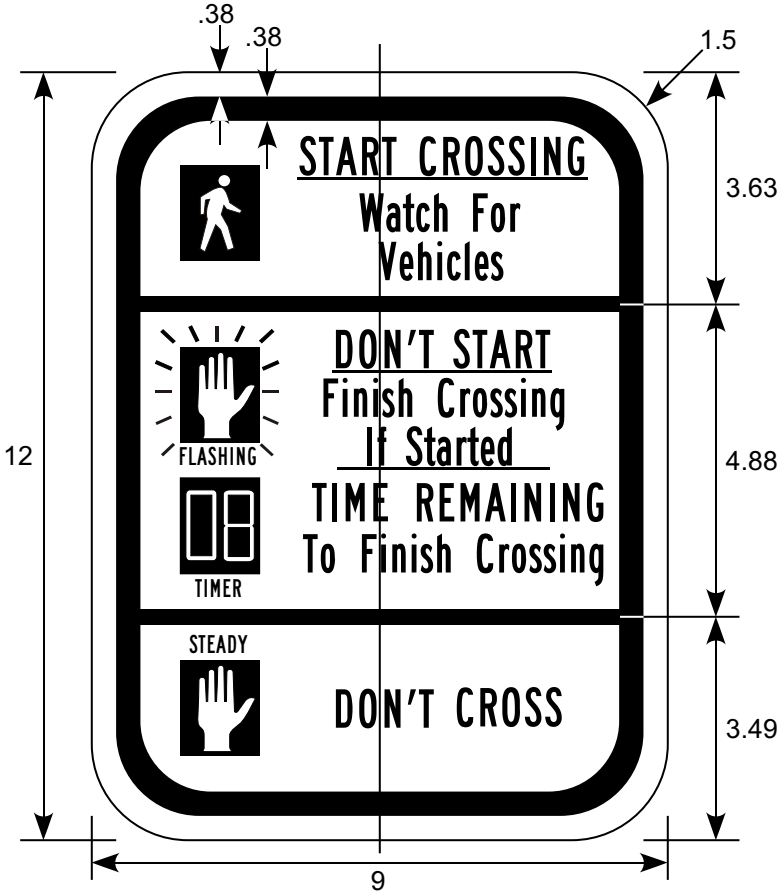

Legend and Border: Black
 Background: White
 08 and Hand Symbol: Orange

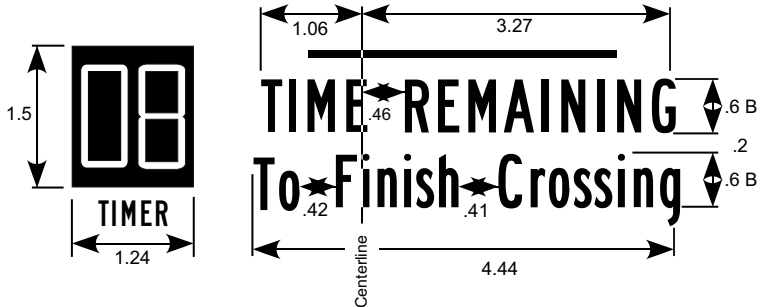

Refer to R10-3B for additional symbol, text size, and word spacing details.

Sign can be attached to a blank or attached directly to signal pole with adhesive backing.



Circle, Diagonal: Red
 Arrow, Border, Legend: Black
 Background: White

*See Appendix B-1 for Standard Arrow Details.

Road Class	Dimensions (inches)													
	A	B	C	D	E	F	G	H	J	K	L	M	N	P
Conv & Min	30	24	0.38	10.5	8.5	1.5	2.5	10.5	11.5	2.0	4D	2.5	0.63	1.5
Expressway	36	30	0.50	13.13	10.63	1.88	3.13	13.13	14.5	2.5	5D	2.9	0.75	1.88

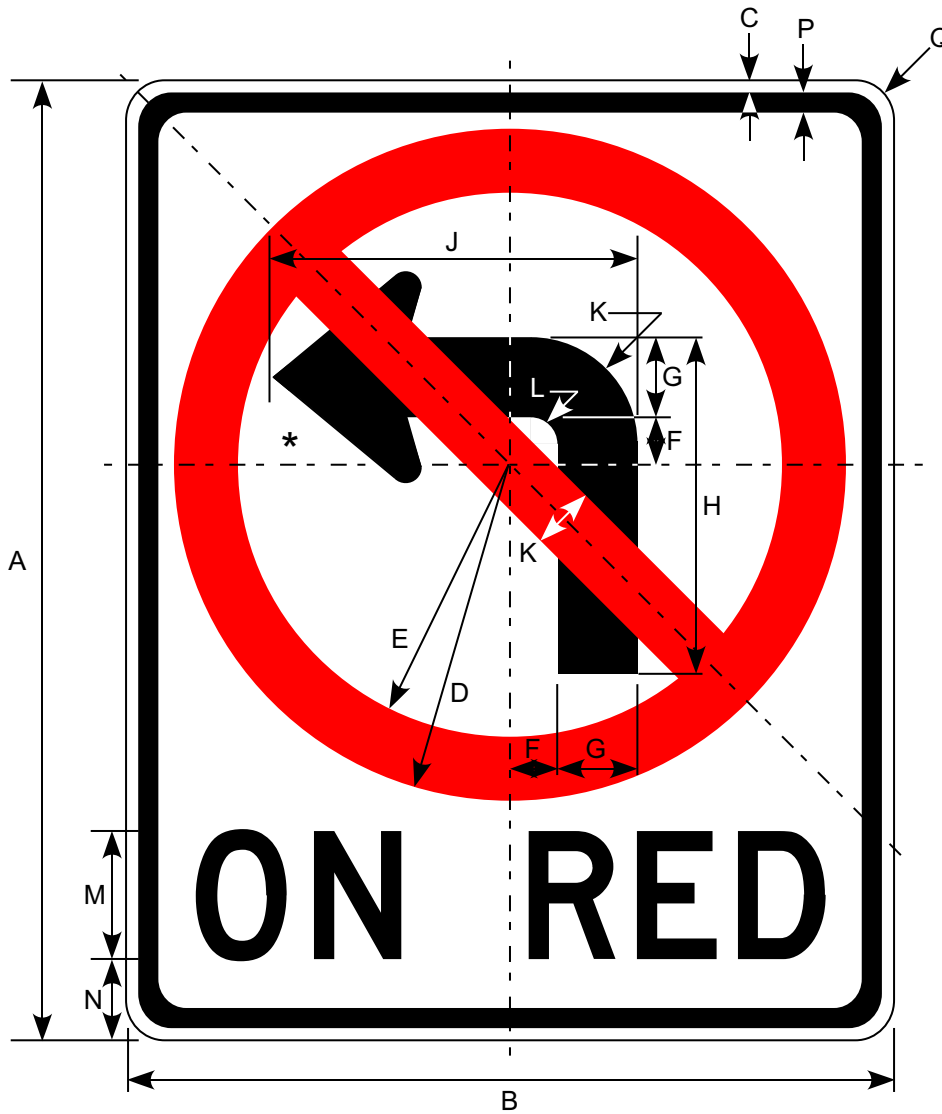

Circle, Diagonal: Red
 Arrow, Border, Legend: Black
 Background: White

*See Appendix B-1 for Standard Arrow Details.

Road Class	Dimensions (inches)														
	A	B	C	D	E	F	G	H	J	K	L	M	N	P	Q
Conv & Min	30	24	0.38	10.5	8.5	1.5	2.5	10.5	11.5	2.0	0.50	4D	3.50	0.63	1.5
Expressway	36	30	0.50	13.13	10.63	1.88	3.13	13.13	14.5	2.5	0.63	5D	4.00	0.75	1.88

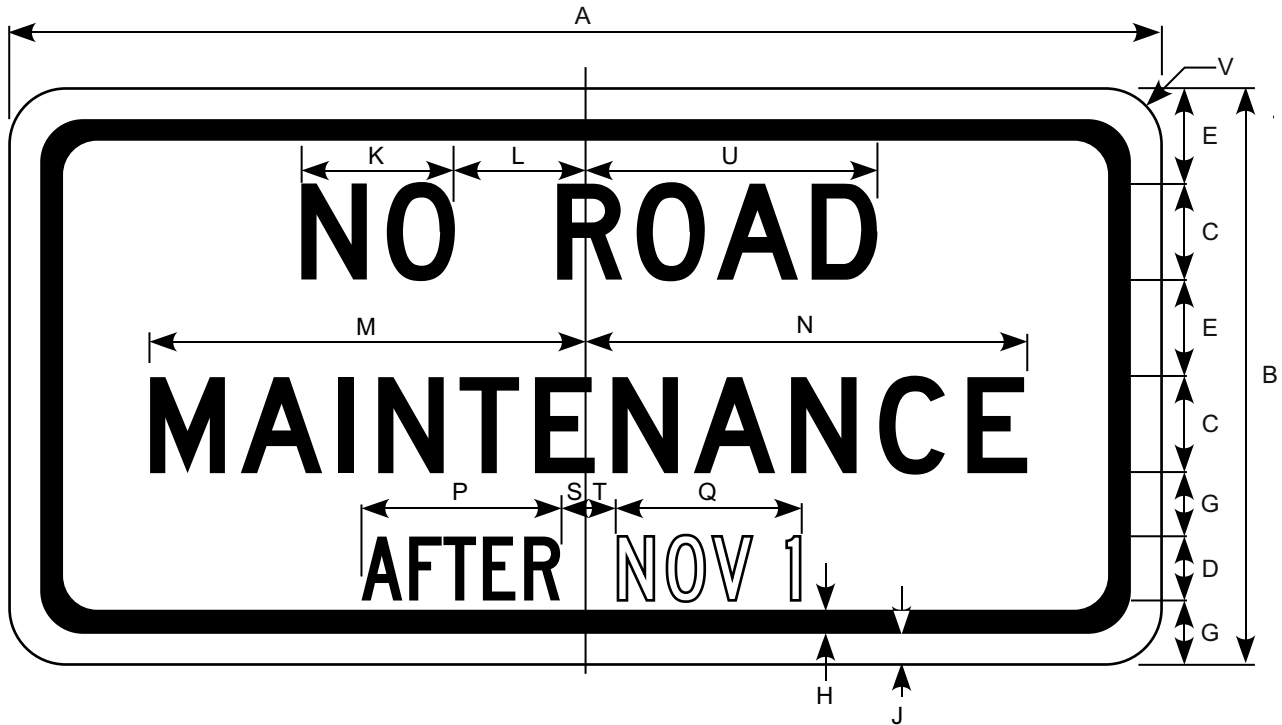

Border and Legend: Black
Background: White

Road Class	Dimensions (inches)									
	A	B	C	D	E	G	H	J	K	L
Minimum	36	18	3D	2C	3.0	2.0	0.63	1.0	4.75	4.13
Conventional	48	24	4D	2D	4.0	3.0	0.88	1.5	6.19	5.50

M	N	P	Q	S	T	U	V
13.63	13.81	6.25	5.81	0.75	0.94	9.13	1.5
18.38	18.38	8.38	7.75	1.0	1.25	10.25	1.5

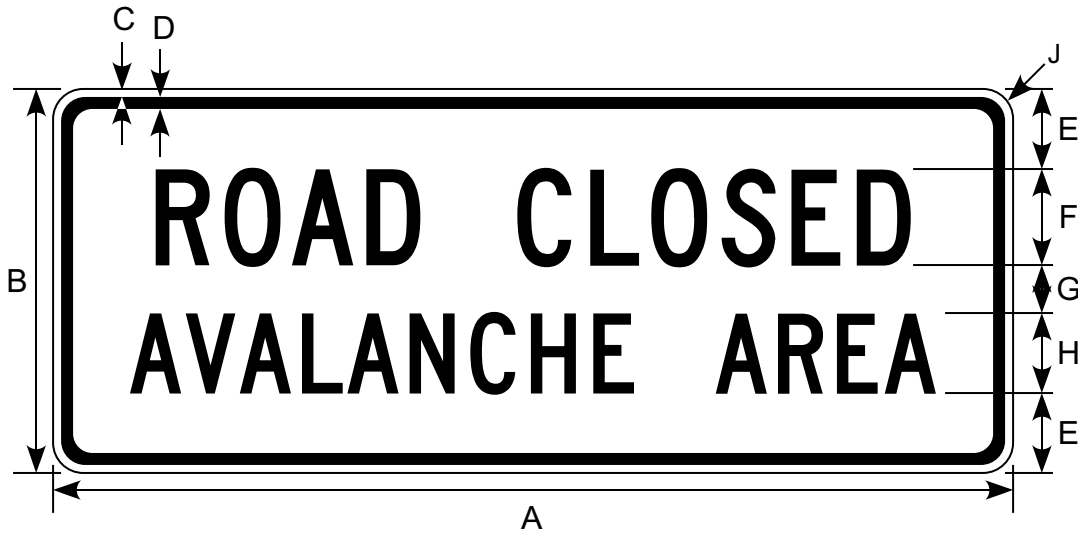

Border and Legend: Black
 Background: White

Road Class	Dimensions (inches)								
	A	B	C	D	E	F	G	H	J
Conv & Min	60	24	0.5	0.75	5	6C	3	5C	1.88

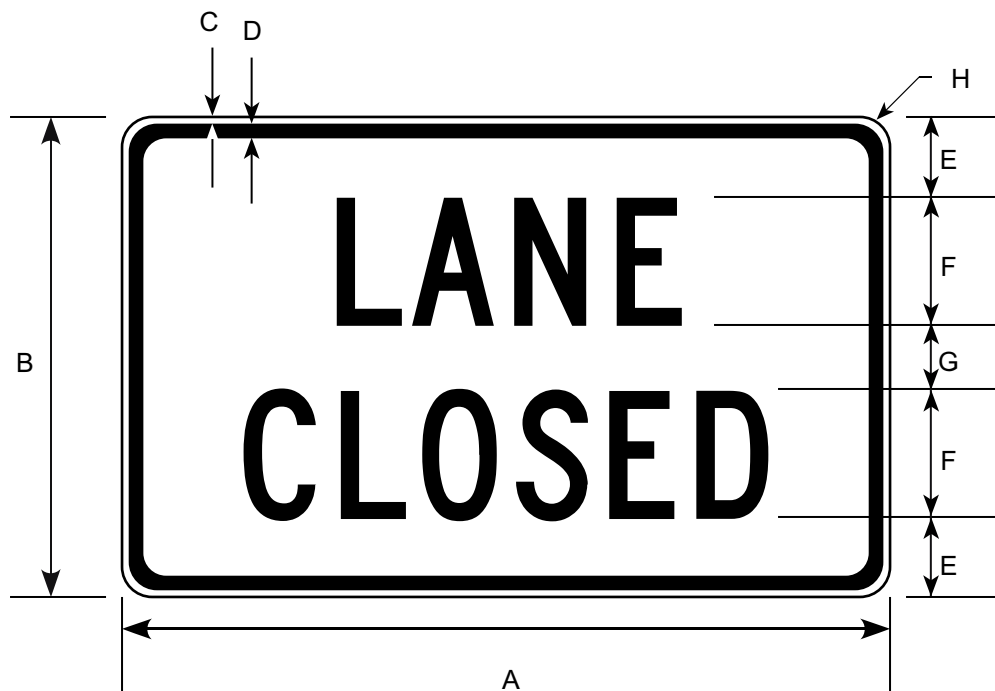

Border and Legend: Black
Background: White

Road Class	Dimensions (inches)							
	A	B	C	D	E	F	G	H
Conv & Min	48	30	0.50	0.75	5	8C	4	1.88

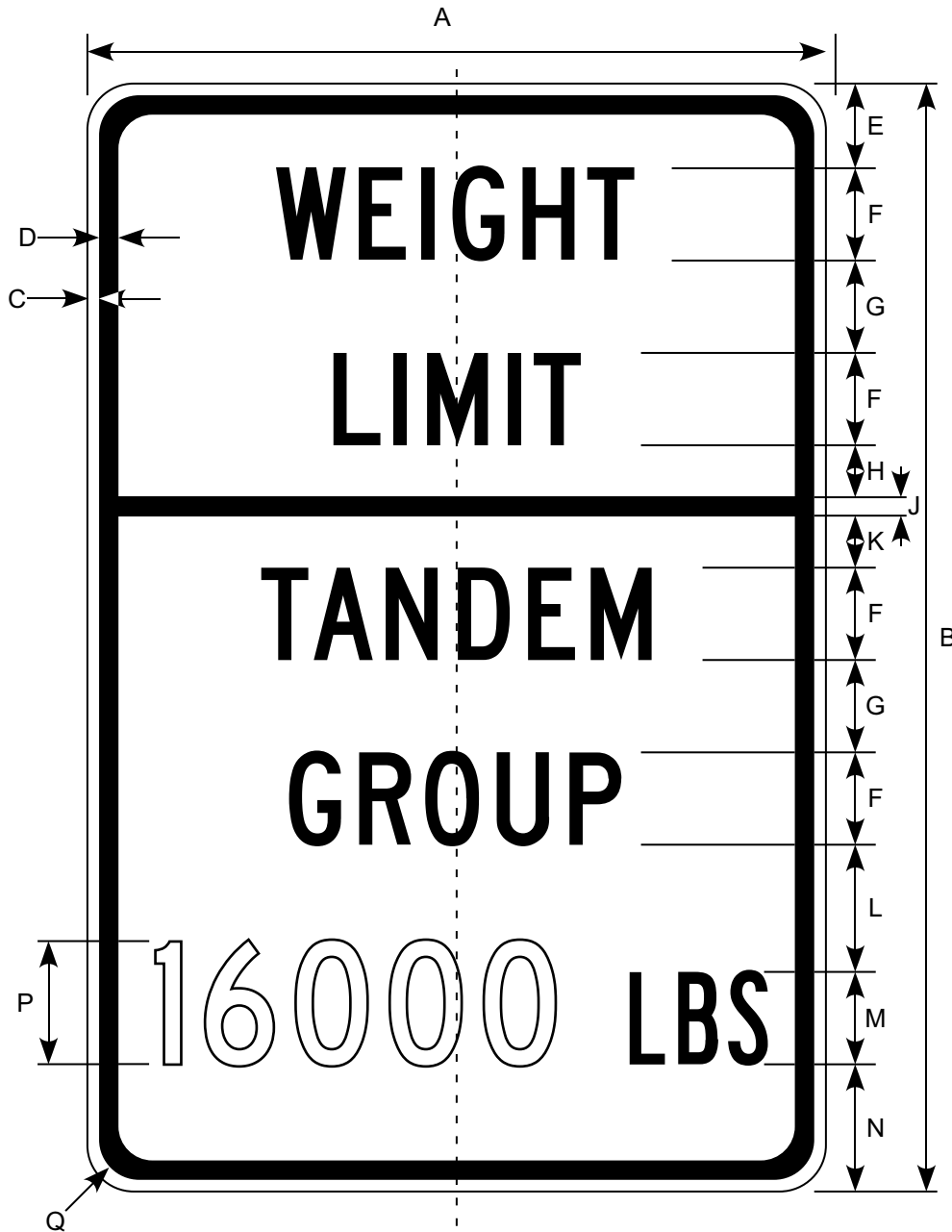

Border and Legend: Black
Background: White

Road Class	Dimensions (inches)														
	A	B	C	D	E	F	G	H	J	K	L	M	N	P	Q
Conv & Min	24	36	0.38	0.63	2.75	3C	3	1.69	0.63	1.69	4.13	3B	4.13	4C	1.5

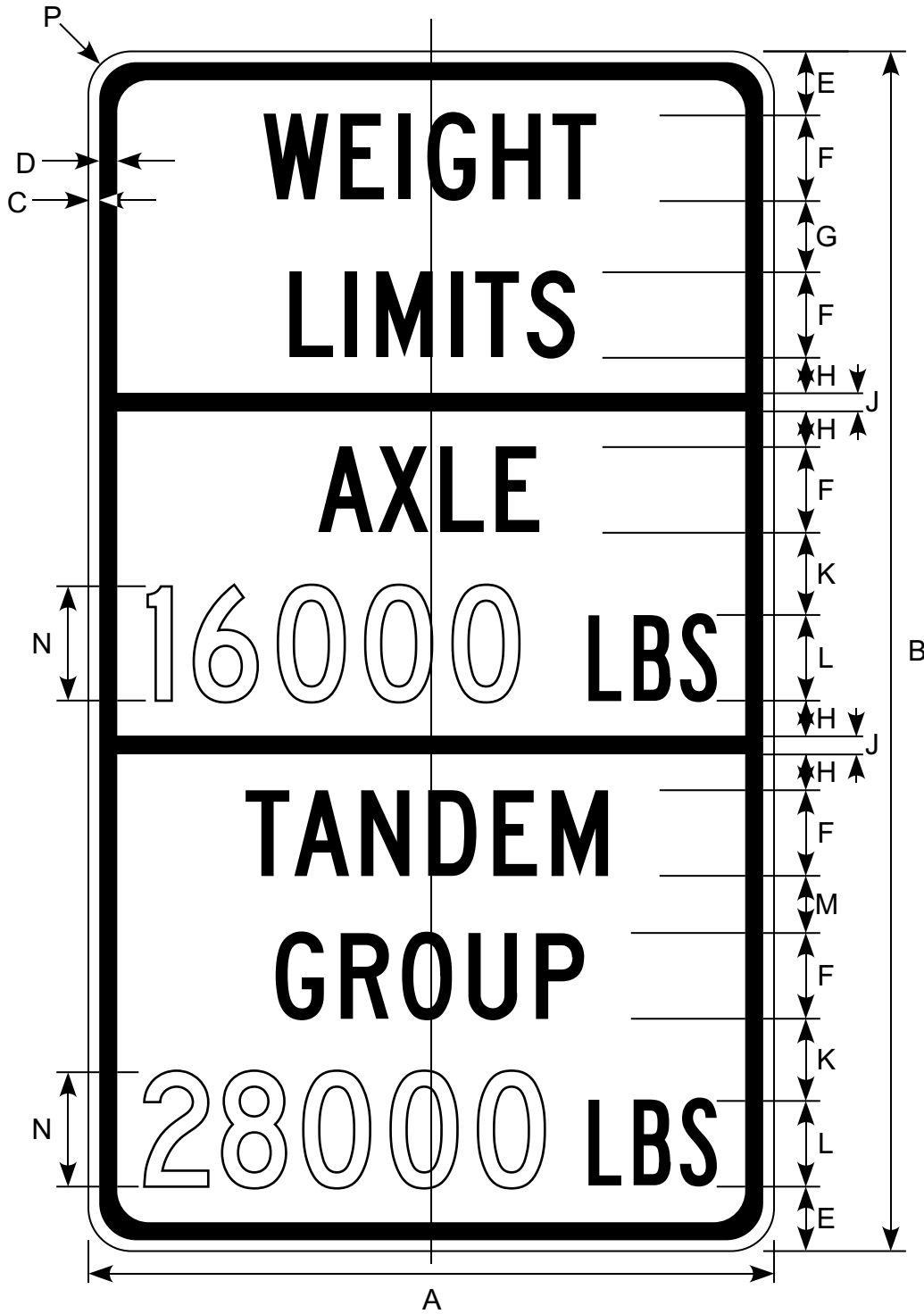

Border and Legend: Black
Background: White

Road Class	Dimensions (inches)													
	A	B	C	D	E	F	G	H	J	K	L	M	N	P
Conv & Min	24	42	0.38	0.63	2.25	3C	2.50	1.25	0.63	2.88	3B	2	4C	1.5

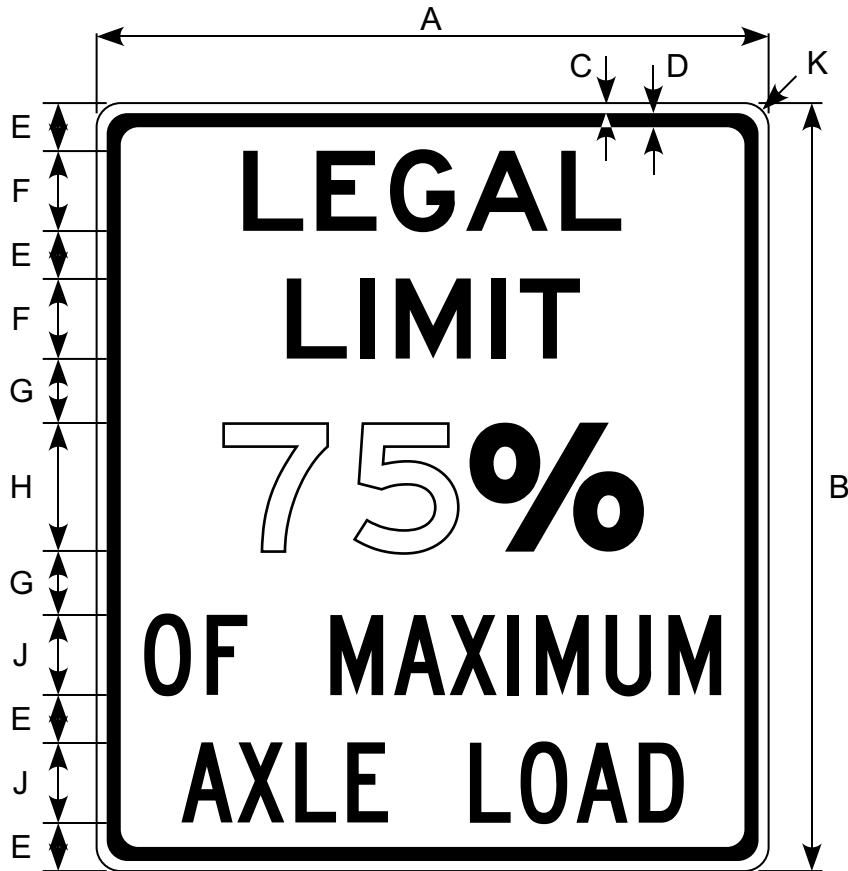

Border and Legend: Black
Background: White

Road Class	Dimensions (inches)									
	A	B	C	D	E	F	G	H	J	K
Conv & Min	42	48	0.63	0.88	3	5E	4	8E	5C	1.5

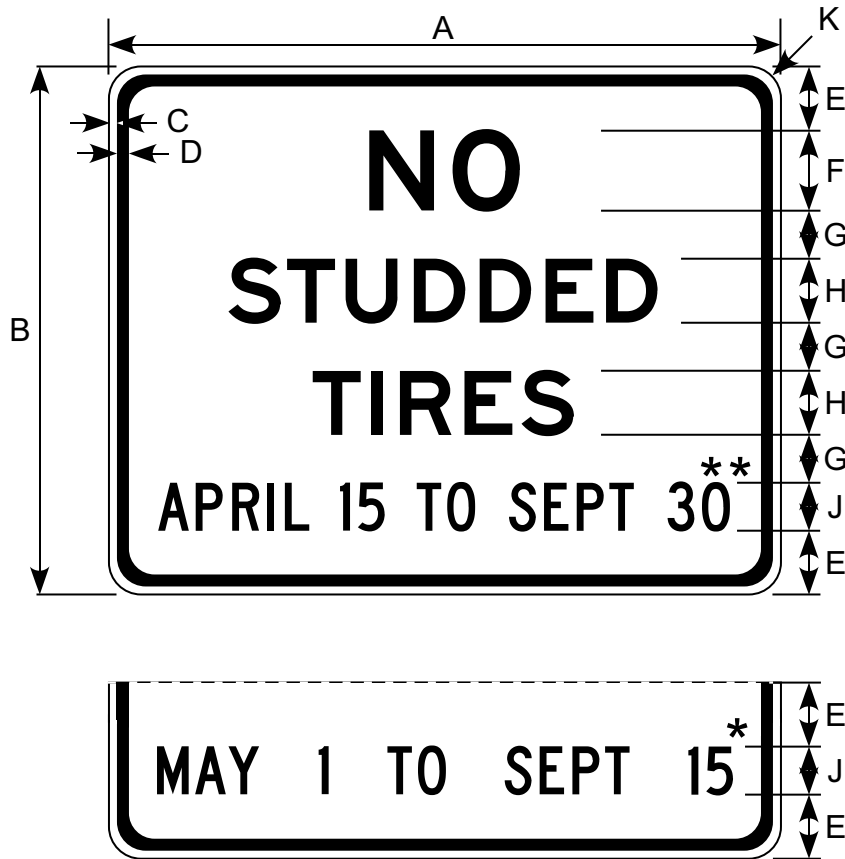

Border and Legend: Black
Background: White

* North of 60 degrees North Latitude: May 1 to Sept. 15

** South of 60 degrees North Latitude: April 15 to Sept. 30

Road Class	Dimensions (inches)									
	A	B	C	D	E	F	G	H	J	K
Conv & Min	84	66	1.0	1.5	8.0	10E	6.0	8E	6C	4.0



Border and Legend: Black
 Background: White

Road Class	Dimensions (inches)								
	A	B	C	D	E	F	G	H	J
Conv & Min	30	36	0.5	0.75	5D	4.0	5C	6.5	1.25



Border and Legend: Black
Background: White



Border and Legend: Black
Background: White

R12-10L Shown. Reverse
arrow for R12-10R.

*See Appendix B-1 for Standard Arrow Details.

Road Class	Dimensions (inches)										
	A	B	C	D	E	F	G	H	J	K	M
Conv & Min	30	36	0.50	0.75	5D	2.75	5.0	4.0	2.5	1.25	17



Border and Legend: Black
 Background: White

Road Class	Dimensions (inches)							
	A	B	C	D	E	F	G	H
Conv & Min	30	36	0.5	0.75	5D	4.0	6.5	1.25

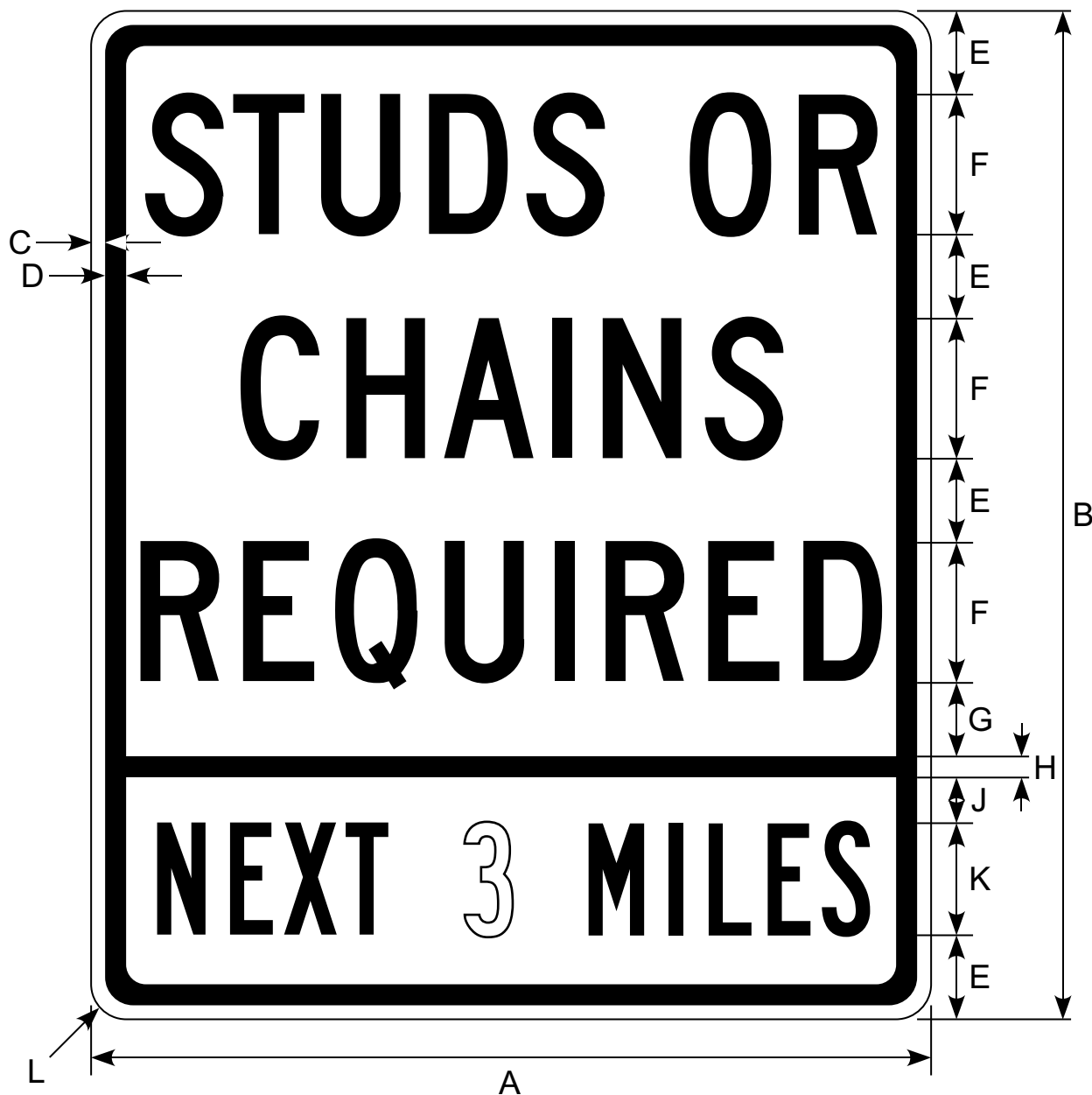

Border and Legend: Black
 Background: White

Road Class	Dimensions (inches)										
	A	B	C	D	E	F	G	H	J	K	L
Min & Std	30	36	0.5	0.75	3	5C	2.63	0.75	1.63	4B	1.25

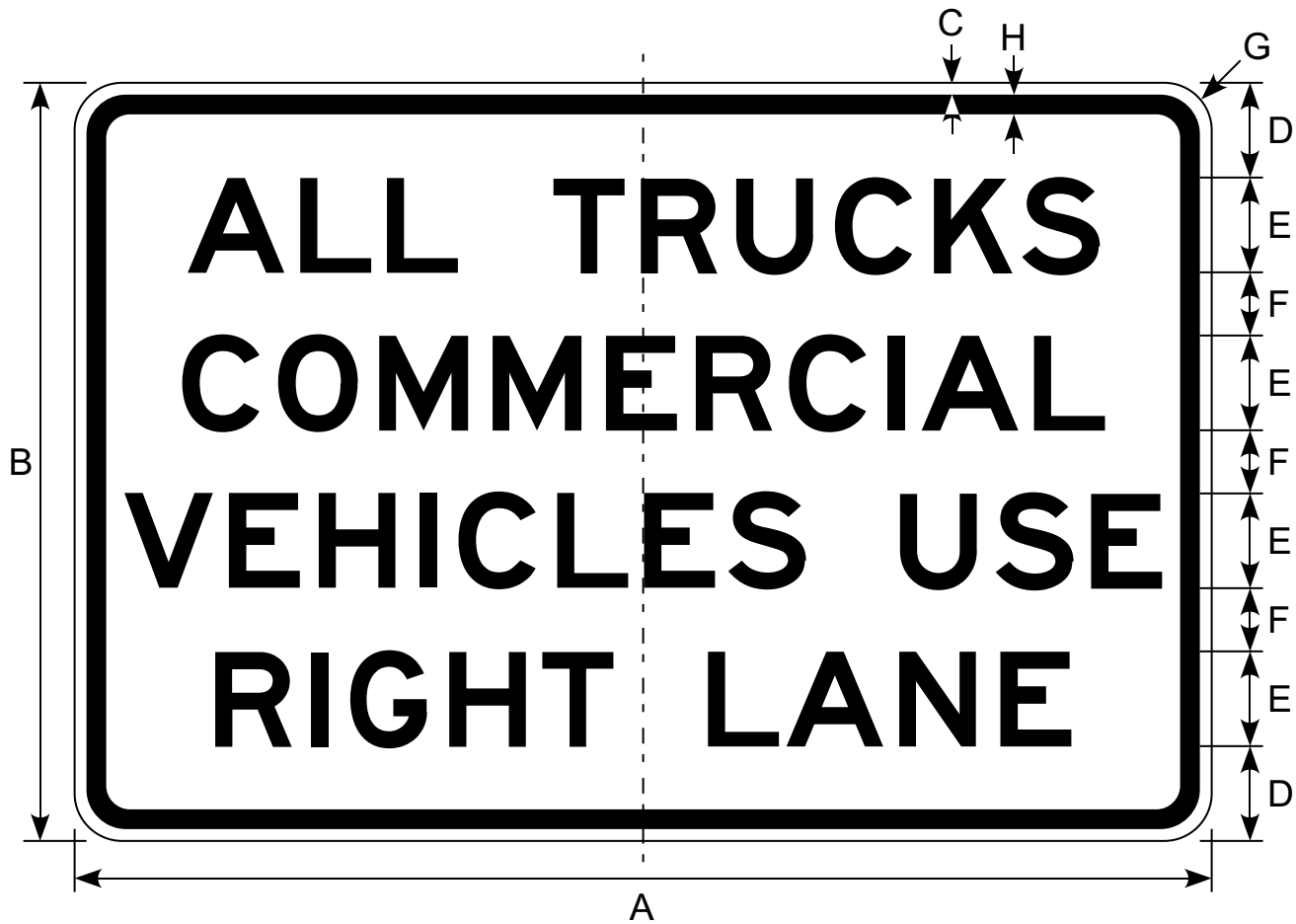

Border and Legend: Black
Background: White

Road Class	Dimensions (inches)							
	A	B	C	D	E	F	G	H
Conventional	72	48	0.75	6	6E	4	3	0.75
Expressway	96	66	0.75	8	8E	6	4	0.75
Freeway	120	84	0.75	10	10E	8	5	0.88

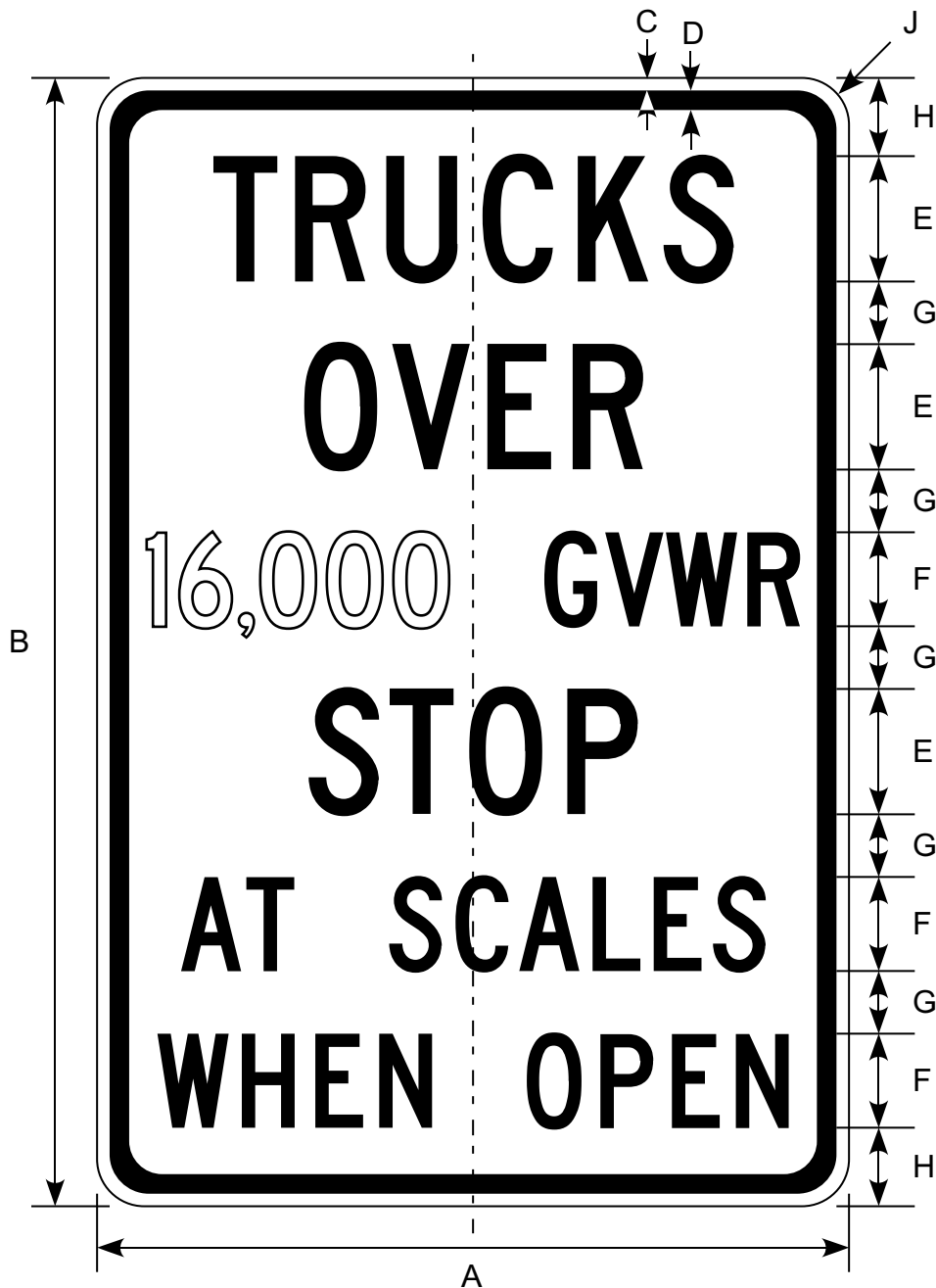

Border and Legend: Black
Background: White

Road Class	Dimensions (inches)								
	A	B	C	D	E	F	G	H	J
Conv & Min	48	72	0.8	1.25	8C	6C	4	5	3

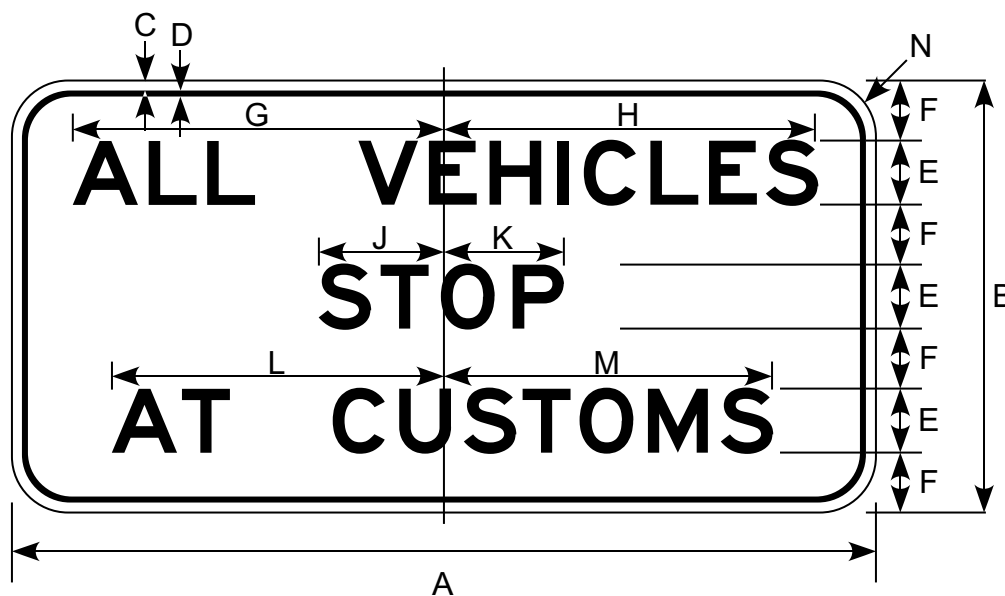

Border and Legend: Black
Background: White

Road Class	Dimensions (inches)												
	A	B	C	D	E	F	G	H	J	K	L	M	N
Conv & Min	84	42	1.25	0.75	6E	6.0	35	34.75	11.5	11.5	31.13	31.13	6.0
Expressway	108	54	1.25	0.75	8E	7.5	46.38	46.38	15.63	15.0	41.5	41	7.0
Freeway	132	66	1.5	0.88	10E	9.0	58	58	19.25	19.0	52	51.63	8.0

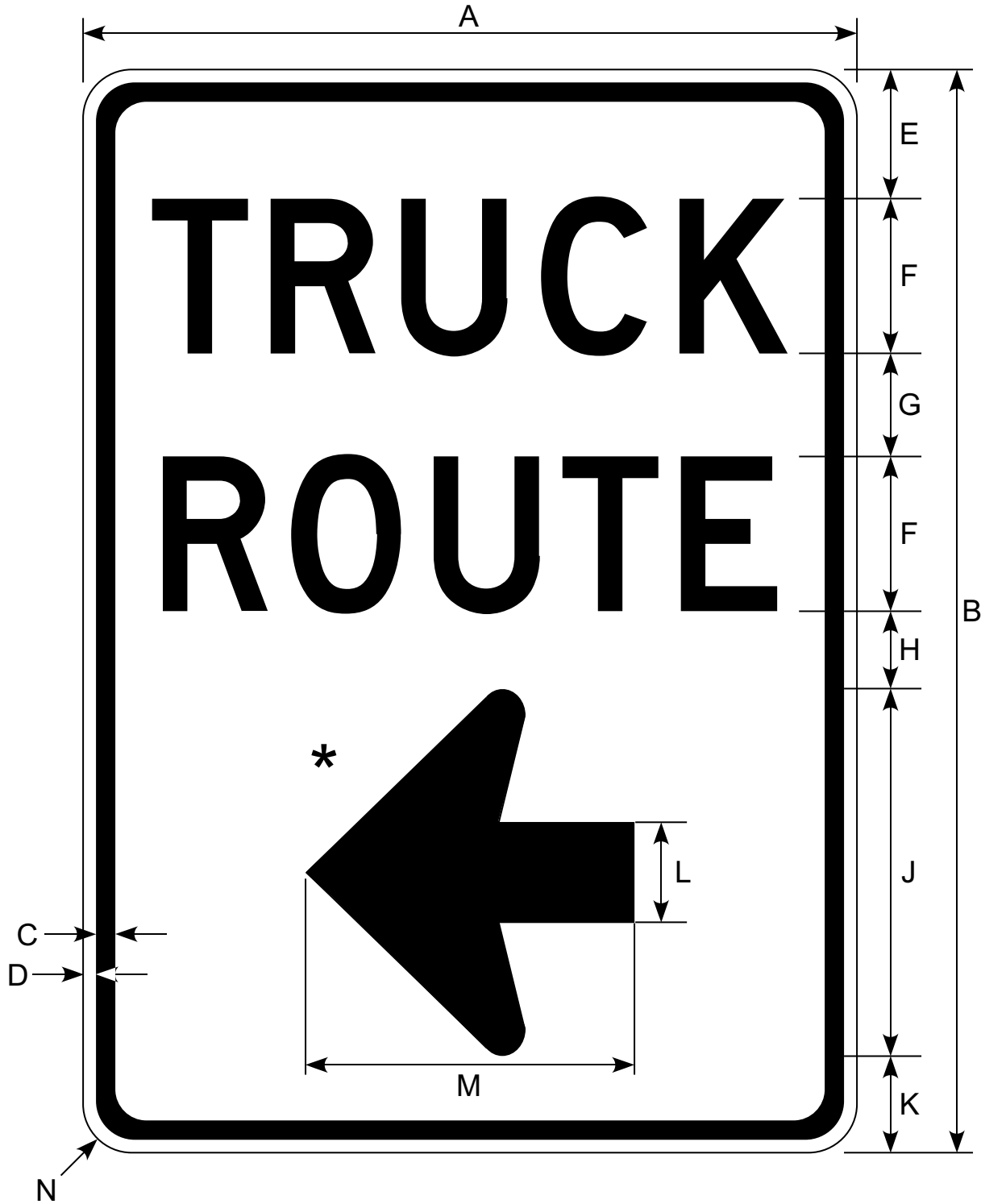

Border and Legend: Black
Background: White

*See Appendix B-1 for Standard Arrow Details.

Road Class	Dimensions (inches)												
	A	B	C	D	E	F	G	H	J	K	L	M	N
Conventional	30	42	0.75	0.50	5.0	6D	4.0	3.0	14.25	3.75	3.88	12.75	1.88

R15-1, R15-2P, R15-3P

Sheet 1 of 2

NOTE: A strip of high-intensity or brighter retroreflective white material not less than 6 inches in width shall be used on the back of each blade of each Crossbuck sign for the length of each blade, at all highway-rail grade crossings, except where Crossbuck signs have been installed back-to-back. A vertical strip of high-intensity or brighter retroreflective white material, not less than 2 inches in width, shall be mounted on each support at passive highway-rail grade crossings for the full length of the front and back of the support from the Crossbuck sign or Number of Tracks plaque to within 2 feet above the ground, except on the side of those supports where a STOP (R1-1) or YIELD (R1-2) sign or flashing lights have been installed or on the back side of supports for Crossbuck signs installed on one-way streets.

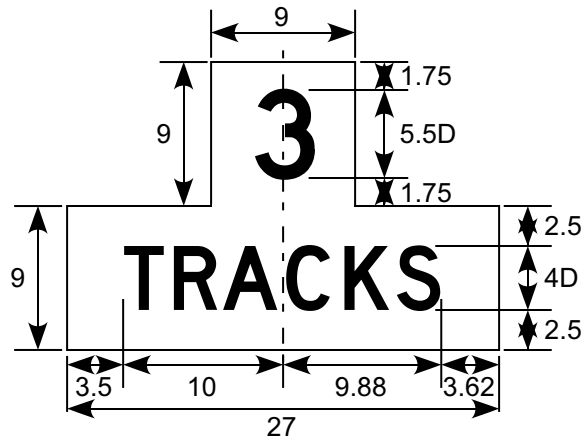
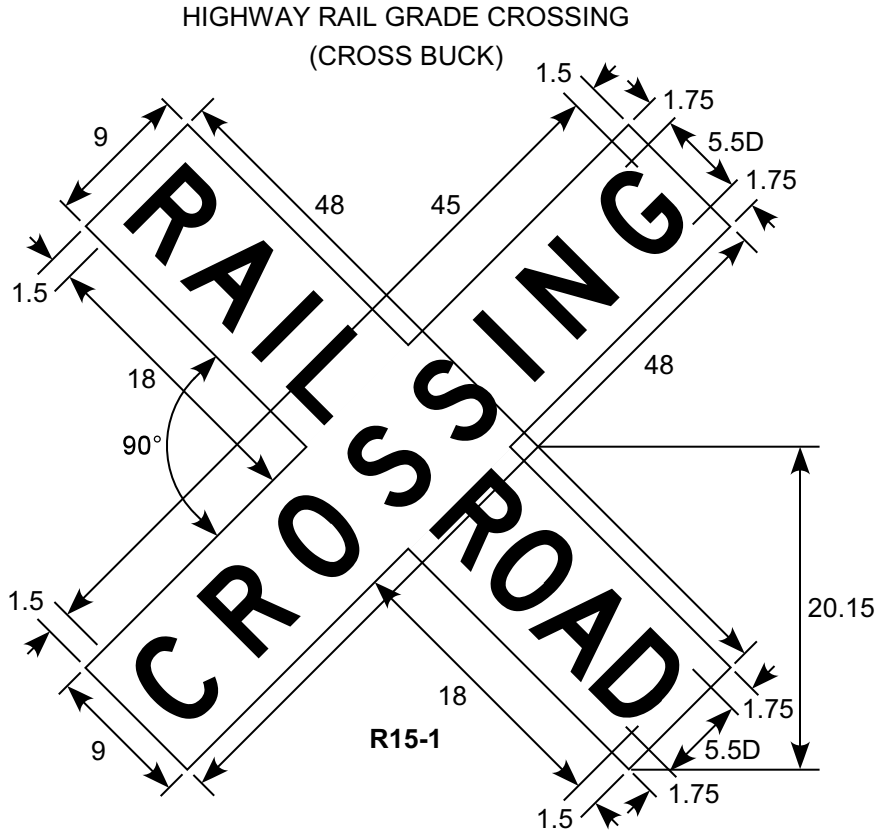

R15-2P NUMBER OF TRACKS

LEGEND - BLACK
BACKGROUND - WHITE (REFLECTIVE)

COLORS FOR W10-1aP FOR USE WITH W10-1:
LEGEND - BLACK
BACKGROUND - YELLOW (RETROREFLECTIVE)

COLORS FOR R15-2P, R15-3P FOR USE WITH R15-1:
LEGEND - BLACK
BACKGROUND - WHITE (RETROREFLECTIVE)

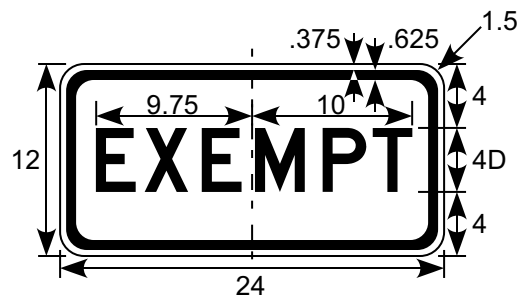

R15-3P/ W10-1aP EXEMPT

R15-1, R15-2P, R15-3P Sheet 2 of 2

NOTE: A strip of high-intensity or brighter retroreflective white material not less than 3 inches in width shall be used on the back of each blade of each Crossbuck sign for the length of each blade, at all highway-rail grade crossings, except where Crossbuck signs have been installed back-to-back. A vertical strip of high-intensity or brighter retroreflective white material, not less than 2 inches in width, shall be mounted on each support at passive highway-rail grade crossings for the full length of the front and back of the support from the Crossbuck sign or Number of Tracks plaque to within 2 feet above the ground, except on the side of those supports where a STOP (R1-1) or YIELD (R1-2) sign or flashing lights have been installed or on the back side of supports for Crossbuck signs installed on one-way streets.

GRADE CROSSING BIKE PATH
(CROSS BUCK)
FOR SHARED USE PATH

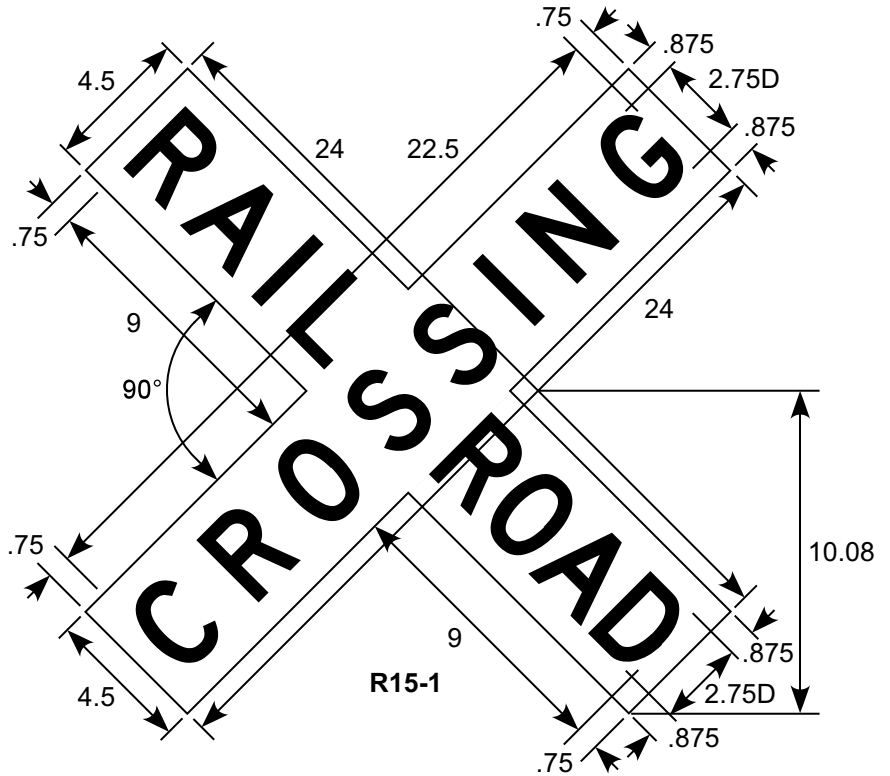

LEGEND - BLACK
BACKGROUND - WHITE (REFLECTIVE)

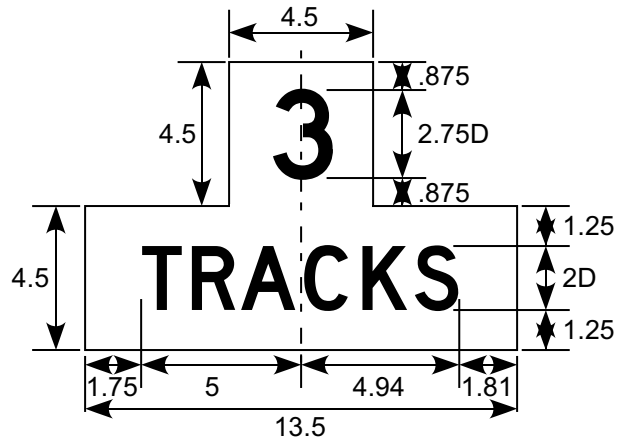

R15-2P NUMBER OF TRACKS

COLORS FOR W10-1aP FOR USE WITH W10-1:
LEGEND - BLACK
BACKGROUND - YELLOW (RETROREFLECTIVE)

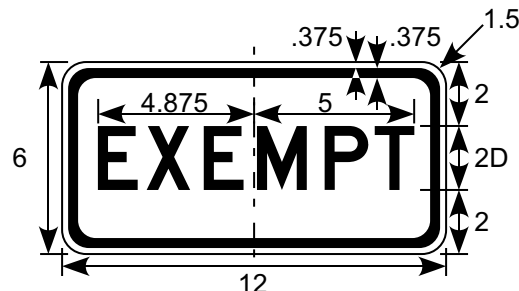

R15-3P/ W10-1aP EXEMPT

COLORS FOR R15-2P, R15-3P FOR USE WITH R15-1:
LEGEND - BLACK
BACKGROUND - WHITE (RETROREFLECTIVE)

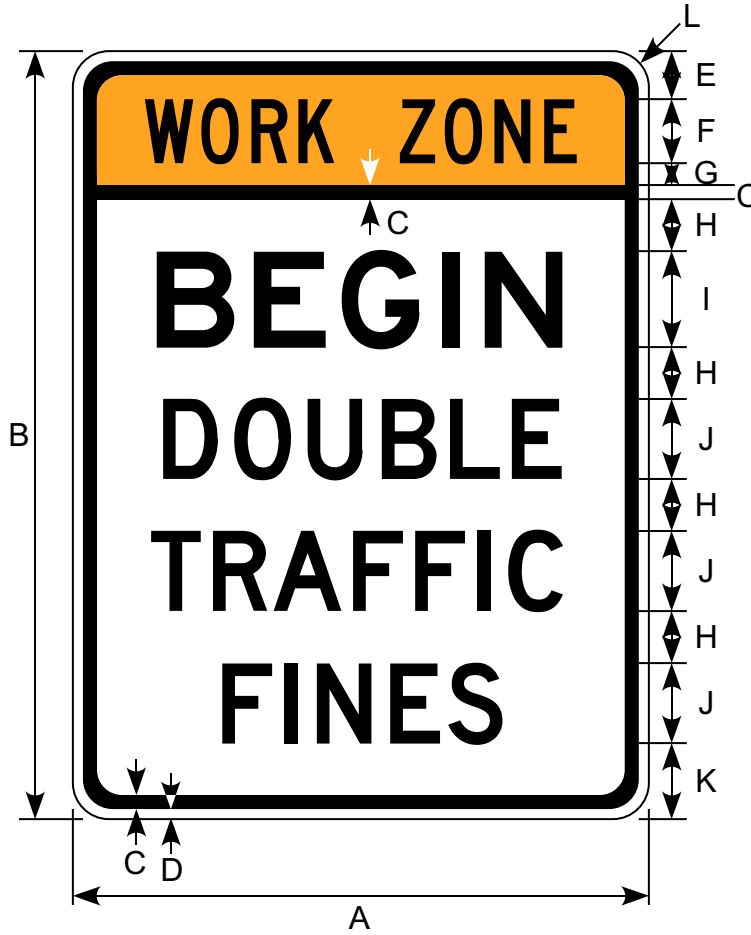

Border and Legend: Black
 Upper Background: Orange
 Lower Background: White

Road Class	Dimensions (inches)											
	A	B	C	D	E	F	G	H	I	J	K	L
Conv & Min	36	48	0.88	0.63	3	4C	1.37	3.25	6E	5D	4.75	2.25



Border and Legend: Black
 Background: White

Road Class	Dimensions (inches)								
	A	B	C	D	E	F	G	H	J
Conv & Min	36	42	0.88	0.63	5.25	5D	3.5	6E	2.25

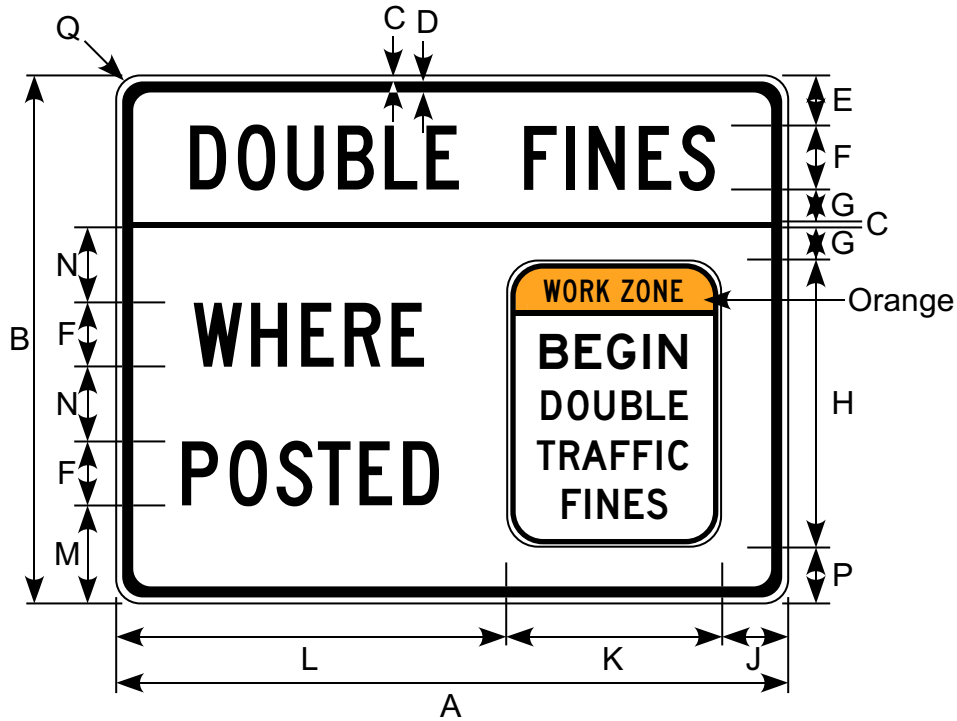

Border and Legend: Black
 Background: White
 "Work Zone" Background: Orange

* "WORK ZONE BEGIN DOUBLE TRAFFIC FINES" insert is 75% of R16-100 dimensions.

Road Class	Dimensions (inches)														
	A	B	C	D	E	F	G	H	J	K	L	M	N	P	Q
Conv & Min	84	66	0.75	1.38	6.25	8C	4.0	36*	8.25	27	48.75	12.24	9.38	7.0	3.0

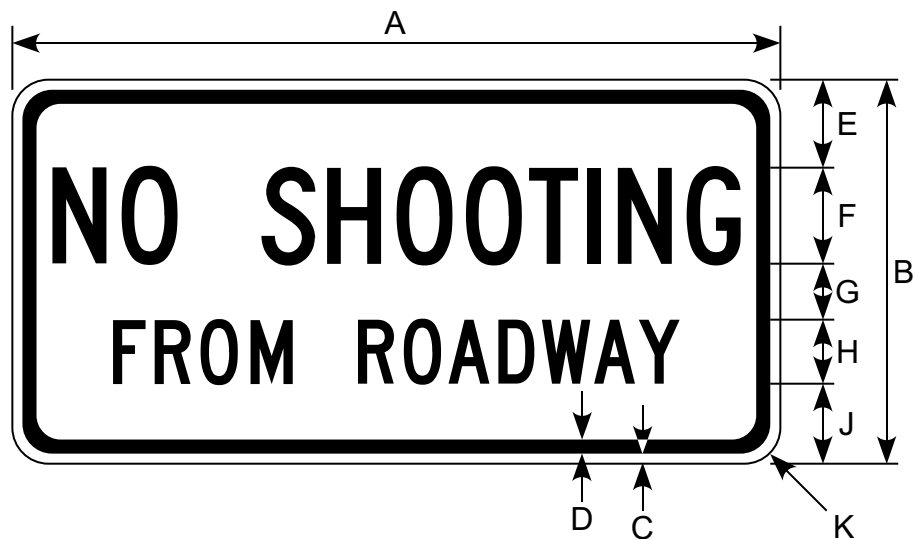

Border and Legend: Black
 Background: White

Road Class	Dimensions (inches)									
	A	B	C	D	E	F	G	H	J	K
Conv & Min	48	24	0.63	0.88	5.5	6C	3.5	4C	5	2.25

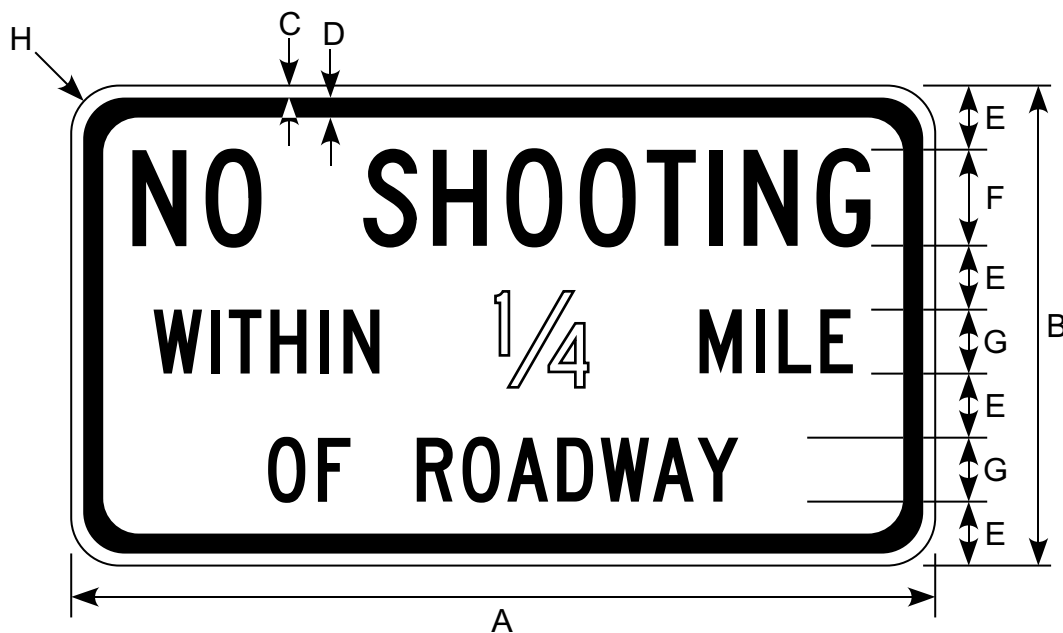

Border and Legend: Black
 Background: White

Road Class	Dimensions (inches)							
	A	B	C	D	E	F	G	H
Conv & Min	54	30	0.75	1.25	4	6C	4C	3



Border and Legend: Black
 Background: White

Road Class	Dimensions (inches)								
	A	B	C	D	E	F	G	H	J
Conv & Min	42	42	0.75	1.25	6	8C	5	6C	2.25



Border and Legend: Black
Background: White

Road Class	Dimensions (inches)							
	A	B	C	D	E	F	G	H
Conv & Min	18	24	0.38	0.63	3D	2	3	1.5

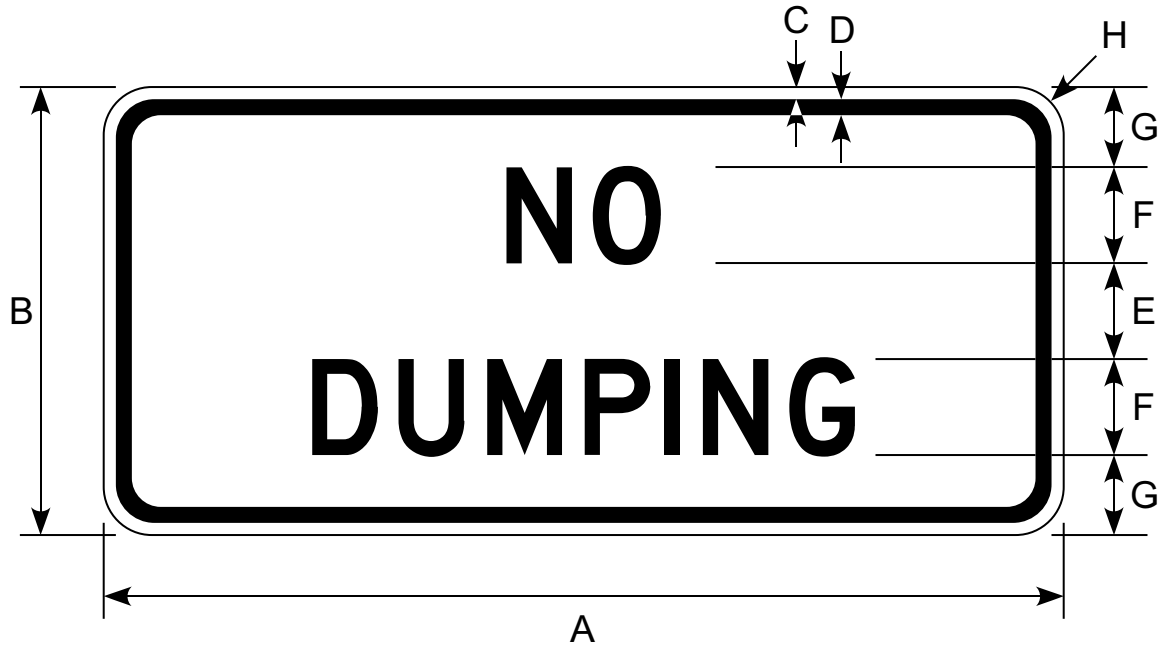

Border and Legend: Black
 Background: White

Road Class	Dimensions (inches)							
	A	B	C	D	E	F	G	H
Conv & Min	30	14	0.38	0.5	3	3D	2.5	1.5



Border and Legend: Black
 Background: White

Road Class	Dimensions (inches)									
	A	B	C	D	E	F	G	H	J	K
Conventional	42	30	0.63	0.88	5C	6C	5B	4.0	3.0	2.25



Border and Legend: Black
 Background: White

Road Class	Dimensions (inches)								
	A	B	C	D	E	F	G	H	J
All	48	36	0.63	0.88	3	4	6E	4C	2.25

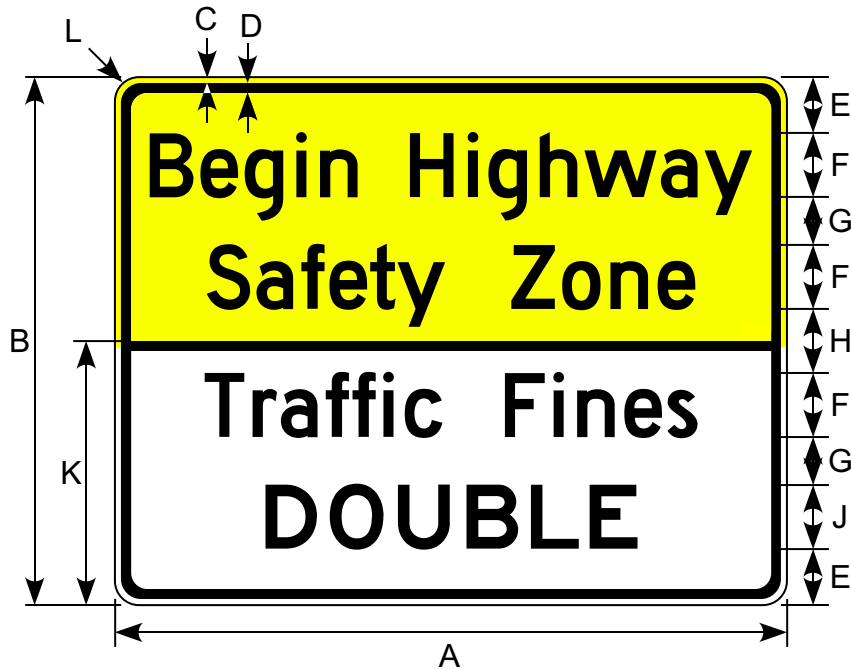

Border and Legend: Black
 Background: White / Fluorescent Yellow

Road Class	Dimensions (inches)										
	A	B	C	D	E	F	G	H	J	K	L
Conventional	84	66	0.75	1.25	7.0	8D	6	8	8E	33	3

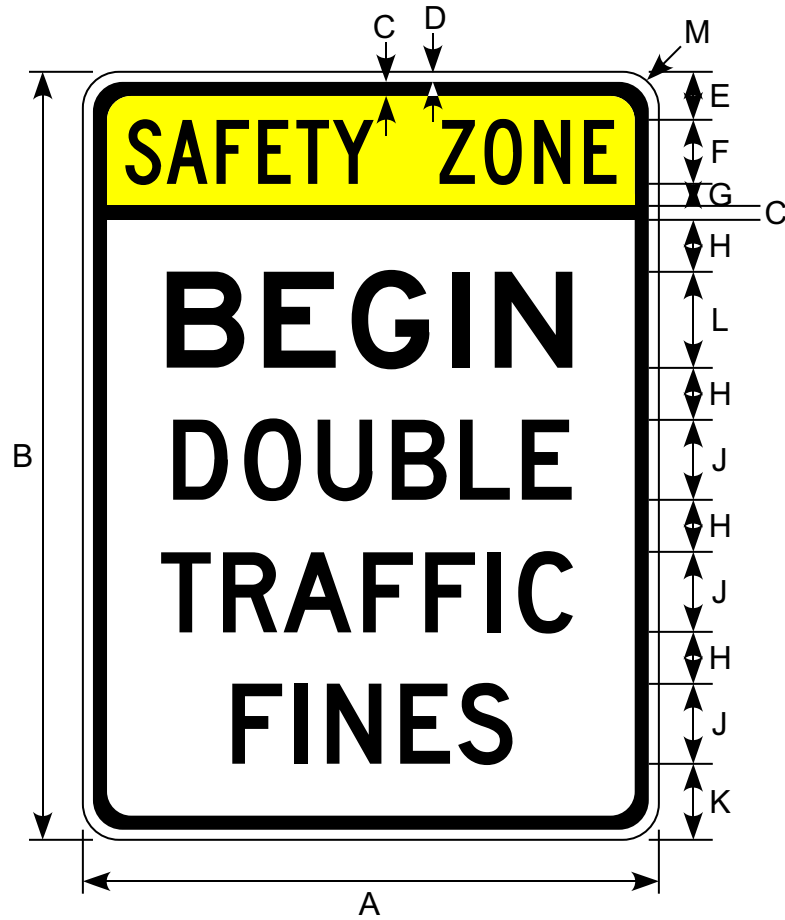

Border and Legend: Black
 Upper Background: Fluorescent Yellow
 Lower Background: White

Road Class	Dimensions (inches)											
	A	B	C	D	E	F	G	H	J	K	L	M
Conv & Min	36	48	0.88	0.63	3	4C	1.38	3.25	5D	4.75	6E	2.25

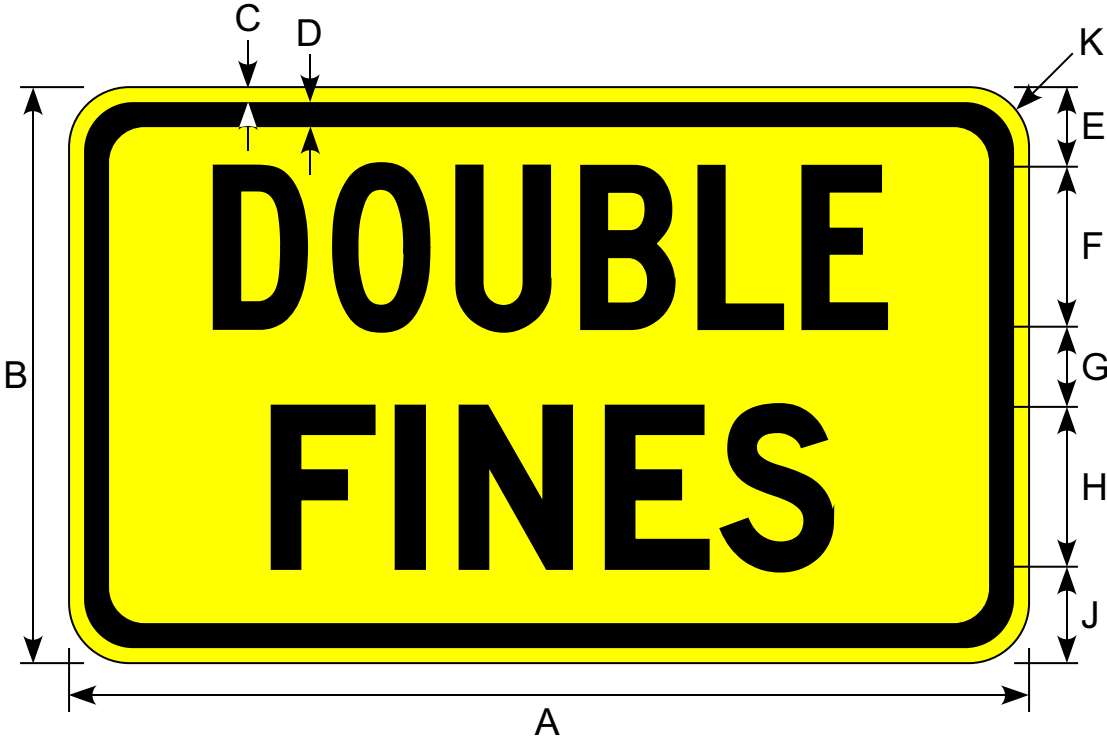

Border and Legend: Black
Background: Fluorescent Yellow or
Fluorescent Orange

Road Class	Dimensions (inches)									
	A	B	C	D	E	F	G	H	J	K
Conventional	30	18	0.50	0.75	2.5	5C	2.5	5D	3	1.88

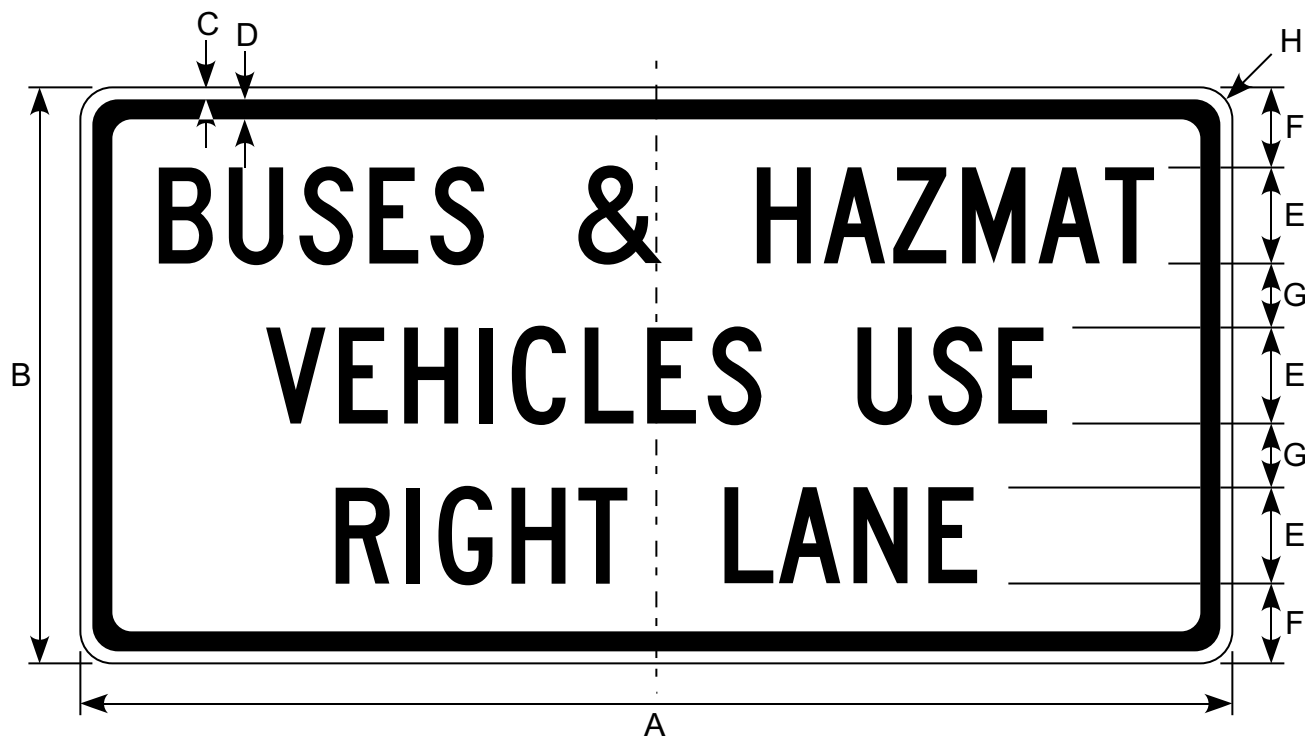

Border and Legend: Black
 Background: White

Road Class	Dimensions (inches)							
	A	B	C	D	E	F	G	H
Conv & Min	72	36	0.75	1.25	6C	5	4	2

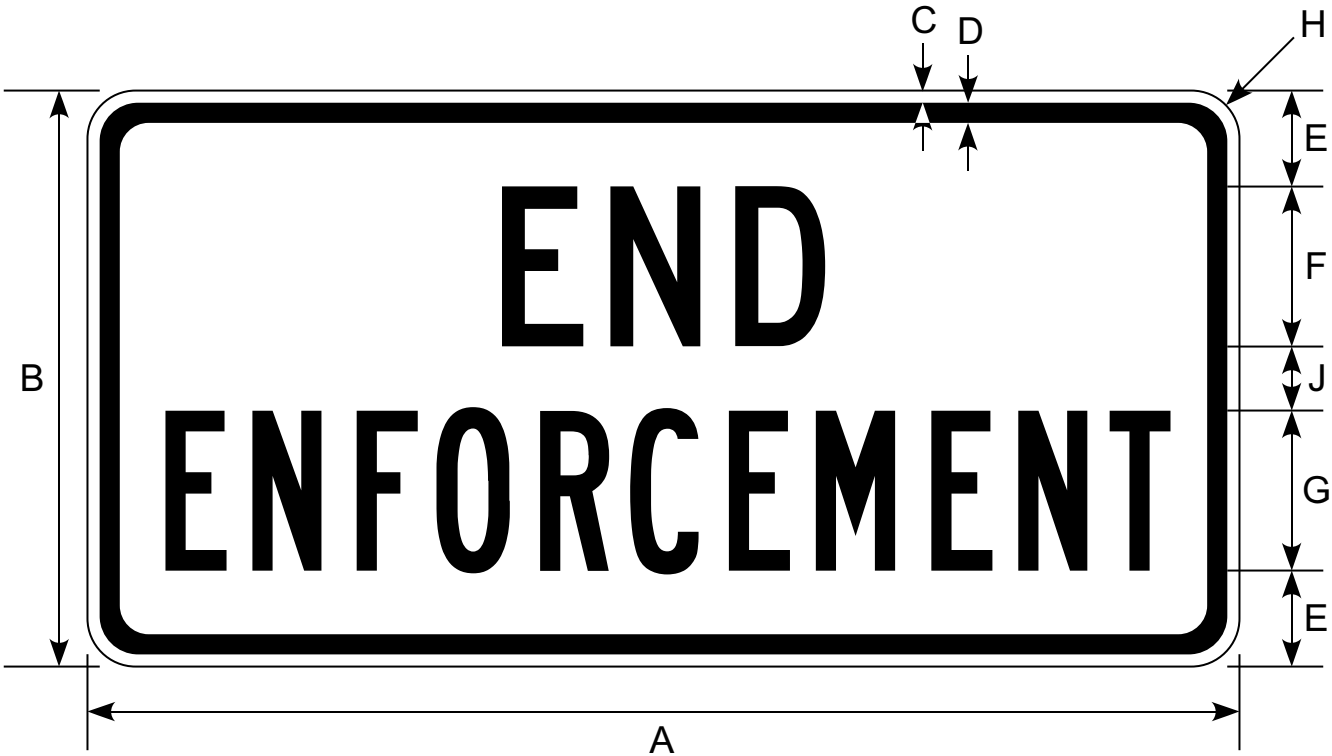

Border and Legend: Black
 Background: White

This sign is typically used with the HEAD-
 LIGHTS ON FOR SAFETY (I-190) sign.

Road Class	Dimensions (inches)								
	A	B	C	D	E	F	G	H	J
Conventional	36	18	0.38	0.63	3.0	5C	5B	1.5	2.0

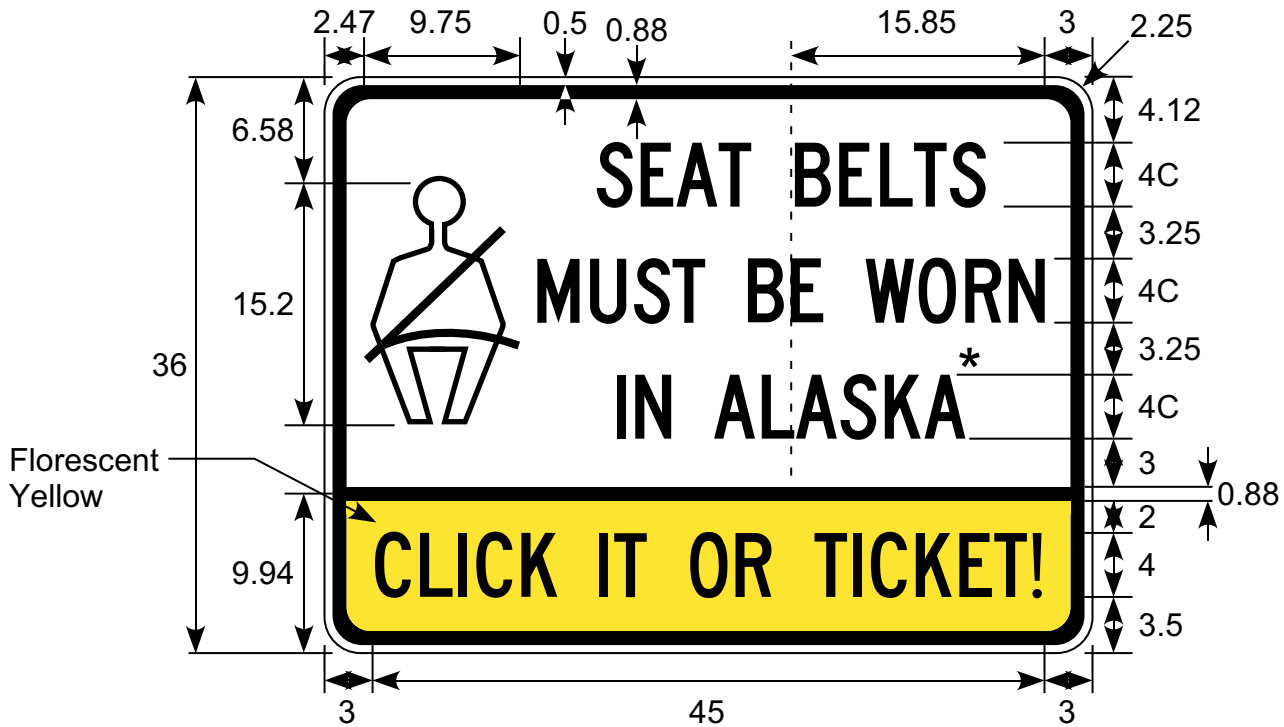

* Inter-character space reduction factor and space width reduction factor are both 33% for all text.

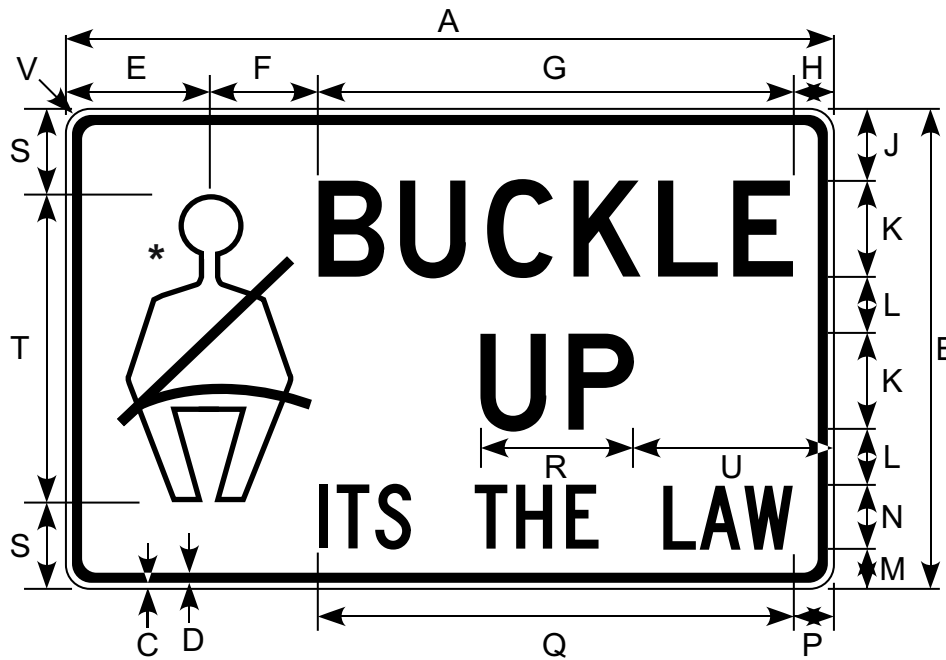

* Make seat belt symbol proportional to the graphic shown.

Border and Legend: Black
Background: White

Road Class	Dimensions (inches)																			
	A	B	C	D	E	F	G	H	J	K	L	M	N	P	Q	R	S	T	U	V
Conv & Min	48	30	0.38	0.63	9.0	6.75	29.75	2.5	4.5	6D	3.5	2.5	4C	2.5	30.5	9.5	5.38	19.25	12.5	1.5

RA, RG, RL, RM, RS, RW Series

RECREATION SIGNS

ASDS SUPPLEMENT SIGNS

RA-020 to RW-500

RA Accommodation Plates (1 of 2)



Campfire
RA-030



Laundry
RA-060



Information
RA-140



Sleeping Shelter
RA-110 *



Showers
RA-130

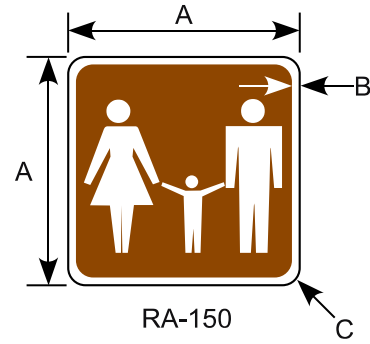

RA-150
Family Rest Room
RA-150



Helicopter
RA 160

* For Non-Road Use

Border and Legend: White
Background: Brown

Make symbol proportional to
graphic shown.

Road Class	Dimensions (inches)		
	A	B	C
Minimum	18	0.38	1.50
Conventional	24	0.63	1.50
Expwy / Fwy	30	0.75	1.88

RA Accommodation Plates (2 of 2)



Bus Stop
RA-020

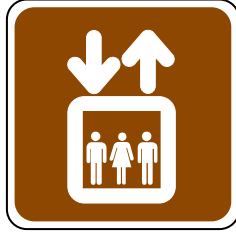

Elevator
RA-040



Kennel
RA-050



Locker
RA-70



Parking
RA-80

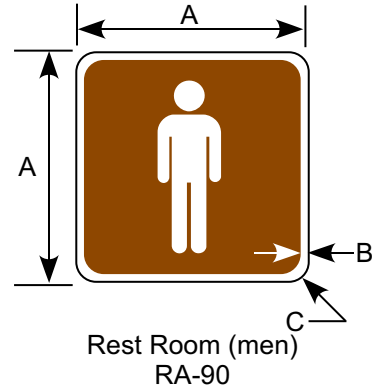

Rest Room (men)
RA-90



Rest Room (women)
RA-100

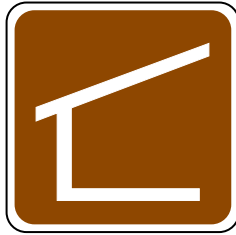

Shelter (trail)
RA-120

Border and Legend: White
Background: Brown

Make symbol proportional to
graphic shown.

Road Class	Dimensions (inches)		
	A	B	C
Minimum	18	0.38	1.50
Conventional	24	0.63	1.50
Expwy / Fwy	30	0.75	1.88

RG General Information Plates (1 of 2)



Litter Container
RG-130

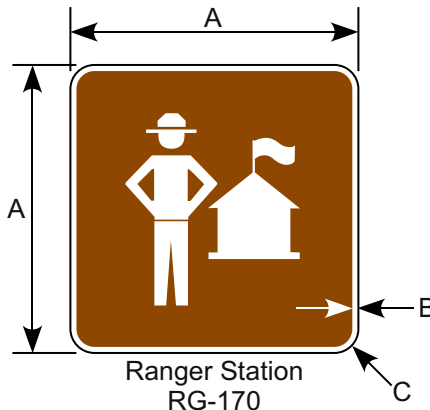

Ranger Station
RG-170



Dog
RG-240



Seaplane
RG-260

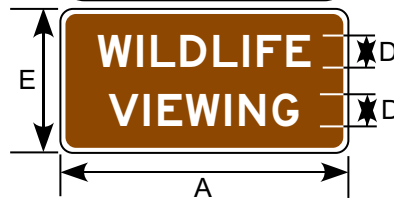

Watchable Wildlife *
RG-1000

Border and Legend: White
Background: Brown

Make symbol proportional to
graphics shown.

* The Watchable Wildlife plates may only be used for officially-approved sites published in the "Alaska Wildlife Viewing Guide," or similar guides developed by ADF&G.

Road Class	Dimensions (inches)						
	A	B	C	D	E	F	G
Minimum	18	0.38	1.50	2E	9	2C	6
Conventional	24	0.63	1.50	3D	12	2E	6
Expwy / Fwy	30	0.75	1.88	4D	15	3D	9

RG General Information Plates (2 of 2)



Automobile
RG-010



Bear Viewing Area
RG-020

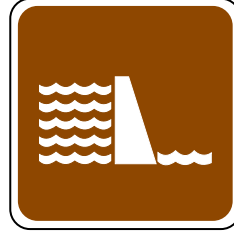

Dam
RG-030

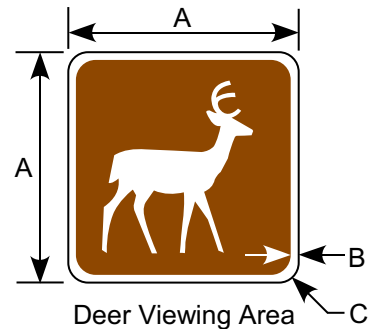

Deer Viewing Area
RG-040



Drinking Water
RG-050



Environmental Study
RG-060



Falling Rock
RG-070

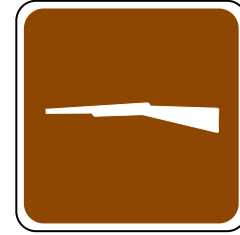

Firearms
RG-080

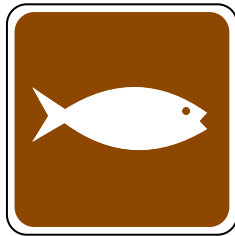

Fish Hatchery
RG-090



Leashed Pets
RG-110



Lighthouse
RG-120



Lookout Tower
RG-140



Pedestrian Crossing
RG-150



Point of Interest
RG-160



Smoking
RG-180



Truck
RG-190



Tunnel
RG-200

Border and Legend: White
Background: Brown
Make symbol proportional to
graphics shown.

Road Class	Dimensions (inches)		
	A	B	C
Minimum	18	0.38	1.50
Conventional	24	0.63	1.50
Expwy / Fwy	30	0.75	1.88

RL Land Recreation Plates (1 of 2)



Amphitheater
RL-010



Rock Climbing
RL-030

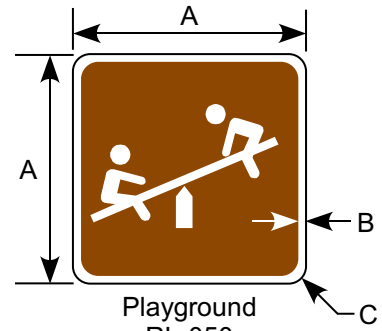

Playground
RL-050



Hiking
RL-100



Horse Riding
RL-110

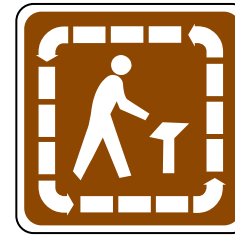

Interpretive Trail
RL-130



4 WD Trail
RL-140



Motorcycle Trail
RL-150



ATV Trail
RL-170



Archery
RL-190



Hang Gliding
RL-210



Golf
RL-500

Road Class	Dimensions (inches)		
	A	B	C
Minimum	18	0.38	1.50
Conventional	24	0.63	1.50
Expwy / Fwy	30	0.75	1.88

Border and Legend: White
Background: Brown

Make symbol proportional to graphic shown.

RL Land Recreation Plates (2 of 2)



Hunting
RL-040



Rock Collecting
RL-060

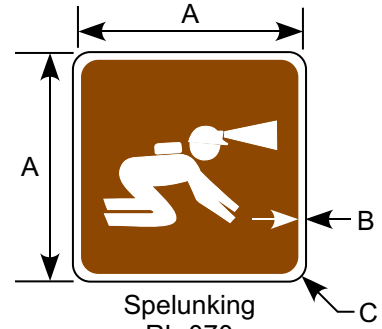

Spelunking
RL-070



Stable
RL-080



Trail (bicycle)
RL-090

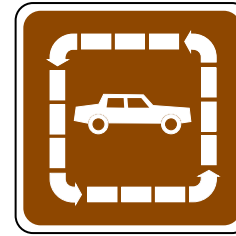

Trail (auto)
RL-120

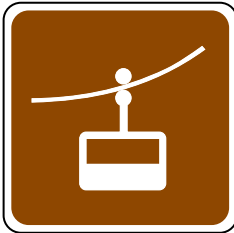

Tramway
RL-160

Border and Legend: White
Background: Brown

Make symbol proportional to
graphic shown.

Road Class	Dimensions (inches)		
	A	B	C
Minimum	18	0.38	1.50
Conventional	24	0.63	1.50
Expwy / Fwy	30	0.75	1.88

RM Motorist Service Plates (1 of 2)



Tent Camping
RM-010



Trailer Camping
RM-020

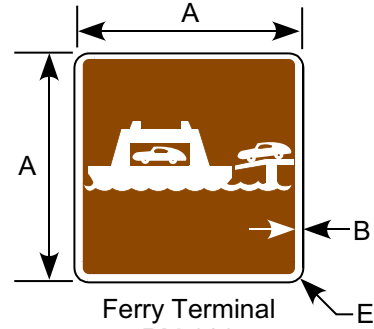

Ferry Terminal
RM-030



Food
RM-050



Gas
RM-060

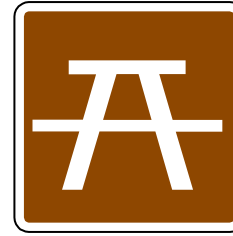

Picnic Area
RM-120

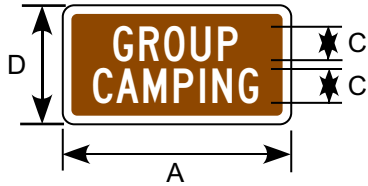

RM-210



Telephone
RM-150



Motor Home
RM-200



Viewing Area
RM-170

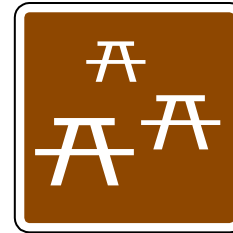

RM-220

Road Class	Dimensions (inches)				
	A	B	C	D	E
Minimum	18	0.38	2C	9	1.50
Conventional	24	0.63	3C	12	1.50
Expwy / Fwy	30	0.75	4C	15	1.88

Border and Legend: White
Background: Brown

Make symbol proportional to graphic shown.

RM Motorist Service Plates (2 of 2)

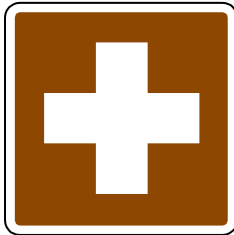

First Aid
RM-040



Grocery Store
RM-070

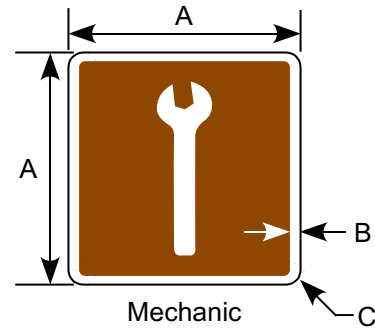

Mechanic
RM-100



Post Office
RM-110

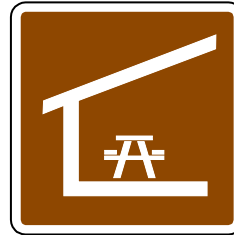

Picnic Shelter
RM-130



Rest Room
RM-140

Border and Legend: White
Background: Brown

Make symbol proportional to
graphic shown.

Road Class	Dimensions (inches)		
	A	B	C
Minimum	18	0.38	1.50
Conventional	24	0.63	1.50
Expwy / Fwy	30	0.75	1.88

RS Winter Recreation Plates (1 of 2)



Skating
RS-010



Ski Jumping
RS-020



Cross-Country Skiing
RS-040



Downhill Skiing
RS-050



Sledding
RS-060

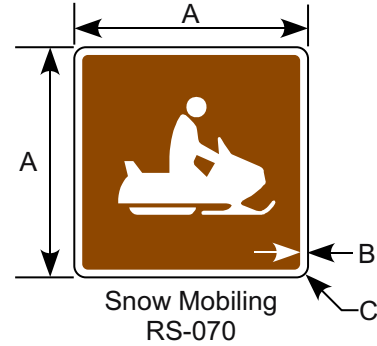

Snow Mobiling
RS-070



Winter Rec Area
RS-090



Chair Lift
RS-100

Border and Legend: White
Background: Brown

Make symbols proportional
to the graphics shown.

Road Class	Dimensions (inches)		
	A	B	C
Minimum	18	0.38	1.50
Conventional	24	0.63	1.50
Expwy / Fwy	30	0.75	1.88

RS Winter Recreation Plates (2 of 2)



Skiing (bobbing)
RS-030

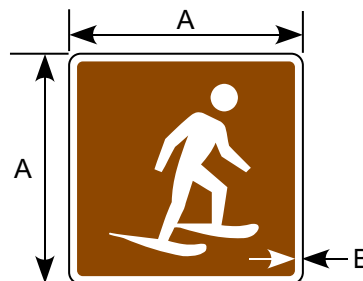

Snowshoeing
RS-080

Border and Legend: White
Background: Brown

Make symbols proportional
to the graphics shown.

Road Class	Dimensions (inches)		
	A	B	C
Minimum	18	0.38	1.50
Conventional	24	0.63	1.50
Expwy / Fwy	30	0.75	1.88

RW Water Recreation Plates (1 of 2)



Canoeing
RW-030

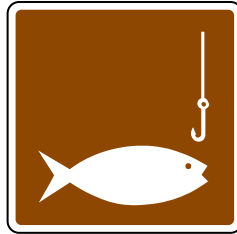

Fishing
RW-050

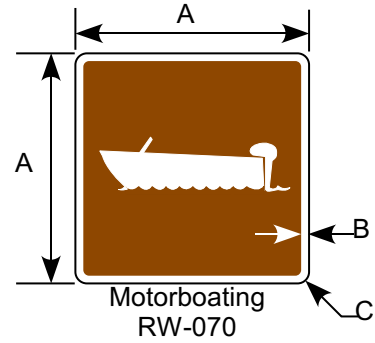

Motorboating
RW-070



Launch Ramp
RW-080

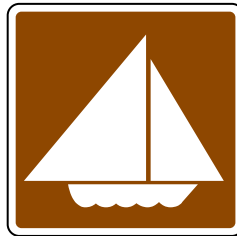

Sailboating
RW-100



Water Skiing
RW-110



Swimming
RW-130



Fishing Pier
RW-160



Hand Launch
RW-170



Kayaking
RW-190



Wind Surfing
RW-210



RW-500

Road Class	Dimensions (inches)			
	A	B	C	D
Minimum	18	0.38	1.50	4C
Conventional	24	0.63	1.50	6C
Expwy / Fwy	30	0.75	1.88	8C

Border and Legend: White
Background: Brown

Make symbol proportional to graphic shown.

RW Water Recreation Plates (2 of 2)

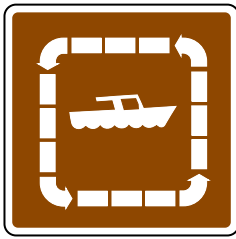

Boat Tours
RW-010



Diving
RW-020

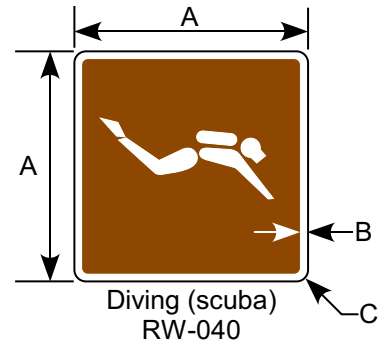

Diving (scuba)
RW-040



Marina
RW-060



Rowboating
RW-090



Surfing
RW-120



Wading
RW-140

Border and Legend: White
Background: Brown

Make symbol proportional to
graphic shown.

Road Class	Dimensions (inches)		
	A	B	C
Minimum	18	0.38	1.50
Conventional	24	0.63	1.50
Expwy / Fwy	30	0.75	1.88

S Series
SCHOOL SIGNS

ASDS SUPPLEMENT SIGNS

S6-100

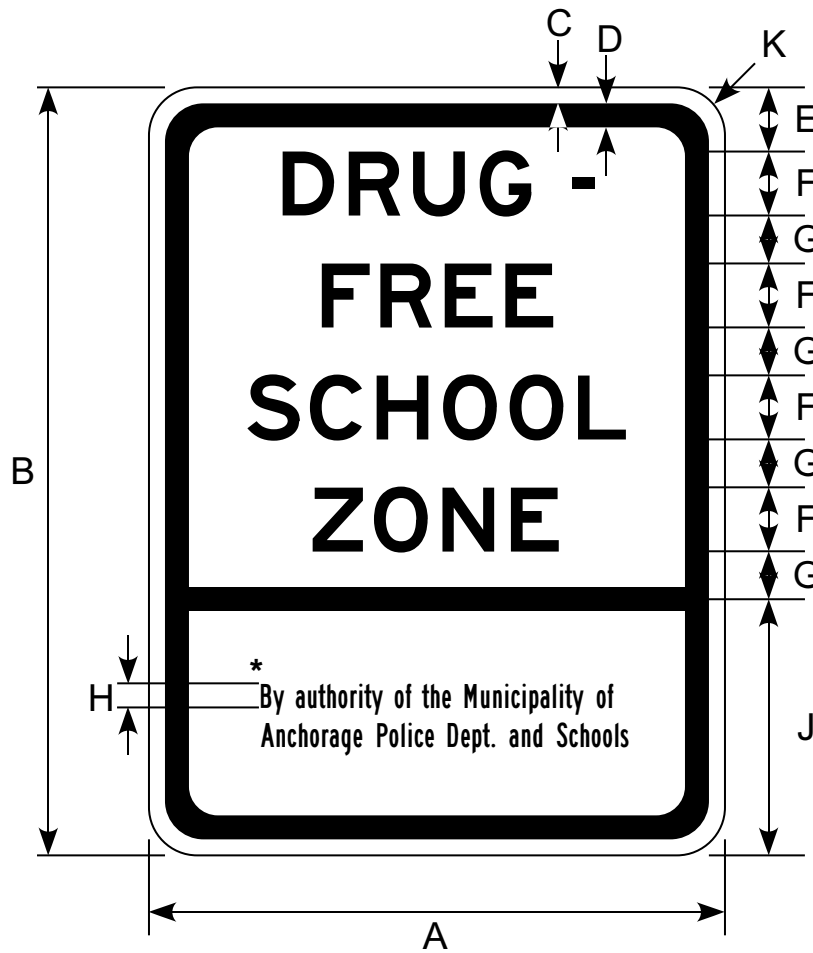

Border and Legend: Black
Background: White

* Legend is variable.

Road Class	Dimensions (inches)									
	A	B	C	D	E	F	G	H	J	K
Conventional	18	24	0.5	0.75	2	2E	1.5	.75B	8	1.5

W Series

WARNING SIGNS

ASDS SUPPLEMENT SIGNS

W4-100 to W23-100

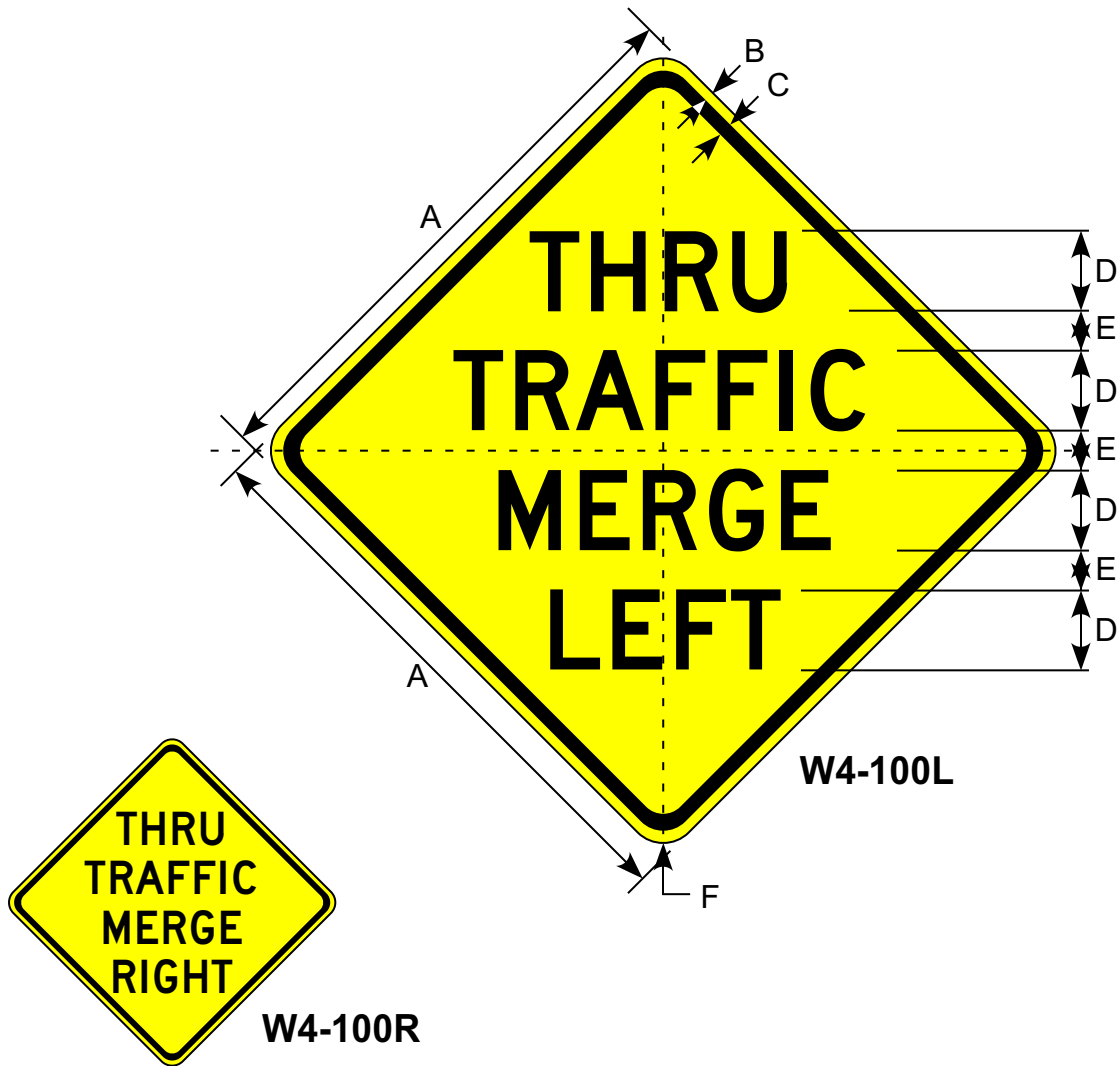

Border and Legend: Black
Background: Yellow

Road Class	Dimensions (inches)					
	A	B	C	D	E	F
Minimum	36	0.63	0.88	5D	2.5	2.25
Conventinal	48	0.75	1.25	6C	3.0	3.0
Expwy/Fwy	60	1.0	1.5	8C	4.0	3.75

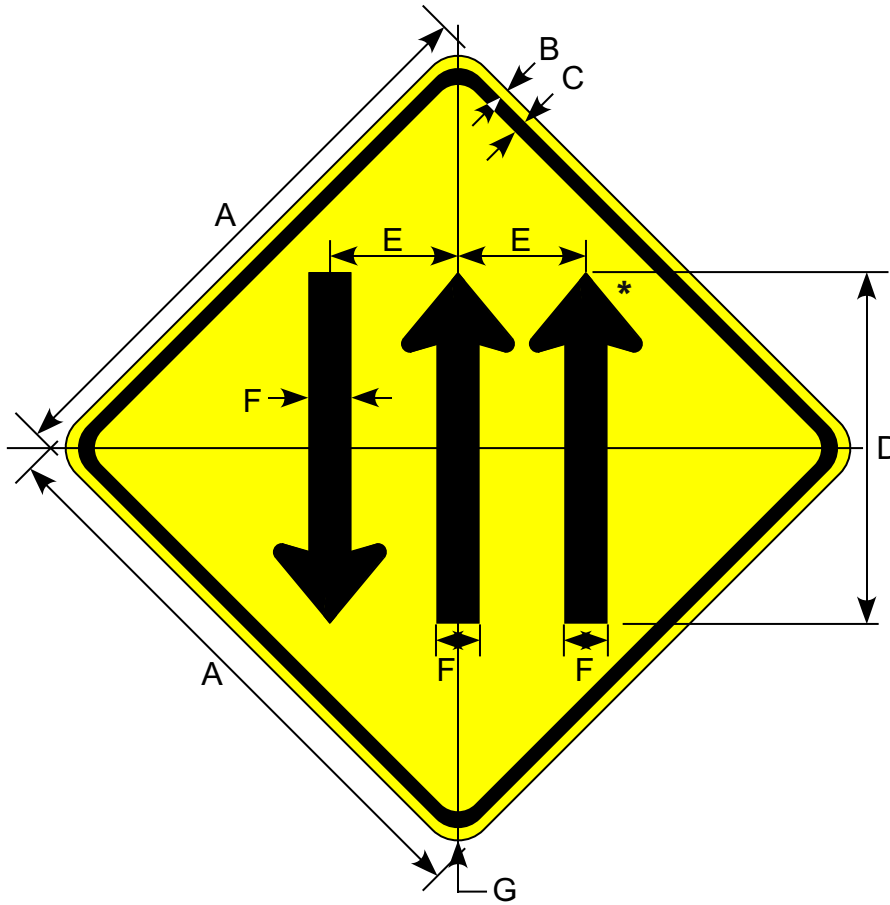

Border and Legend: Black
Background: Yellow

* See Appendix B-1 for Standard Arrow Details.

Road Class	Dimensions (inches)						
	A	B	C	D	E	F	G
Conventional	36	0.63	0.88	22	8.0	2.75	2.25
Expwy/Fwy	48	0.75	1.25	30	11	3.5	3.0

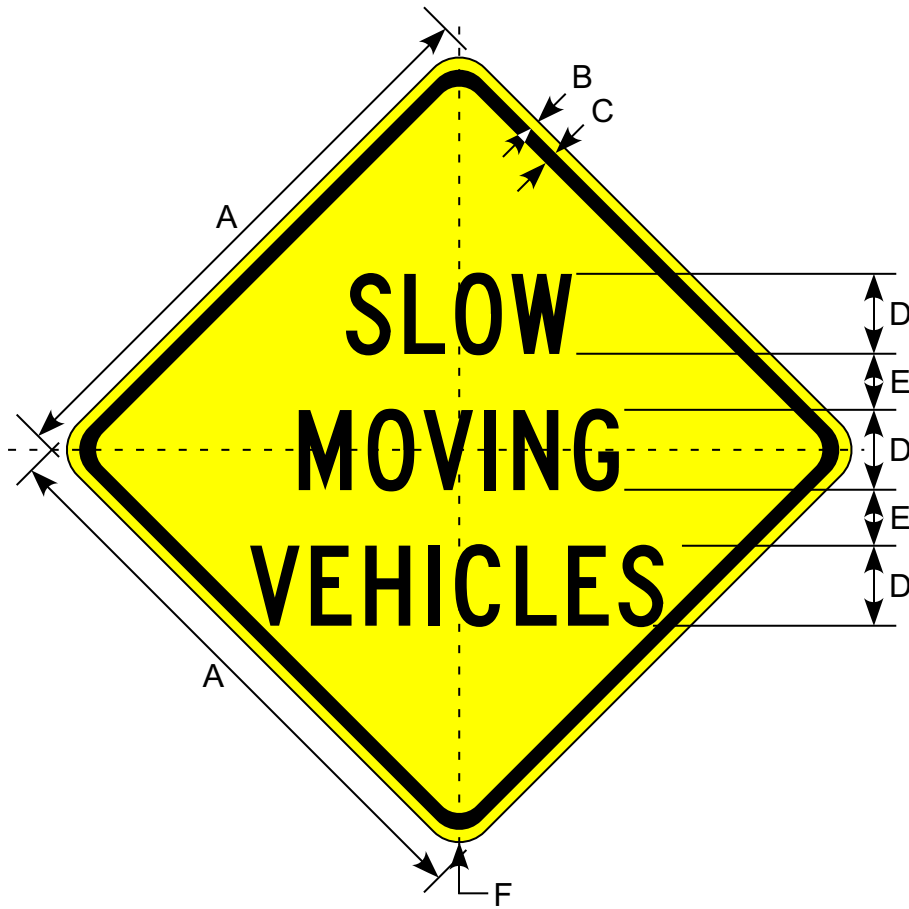

Border and Legend: Black
Background: Yellow

Road Class	Dimensions (inches)					
	A	B	C	D	E	F
Minimum	30	0.50	0.75	4C	3.0	1.88
Conventional	36	0.63	0.88	5C	3.5	2.25
Expwy/Fwy	48	0.75	1.25	7C	4.25	3.0

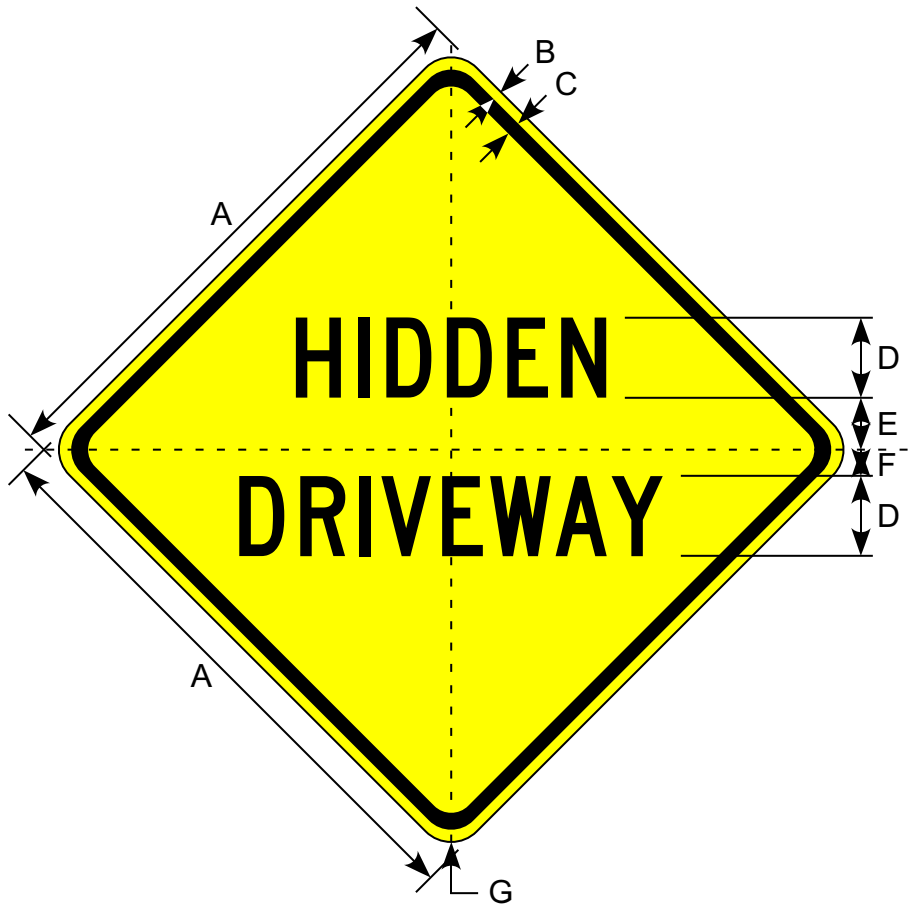

Border and Legend: Black
Background: Yellow

Road Class	Dimensions (inches)						
	A	B	C	D	E	F	G
Minimum	30	0.50	0.75	4C	2.50	1.25	1.88
Conventional	36	0.63	0.88	5C	3.25	1.63	2.25
Expwy/Fwy	48	0.75	1.25	7C	4.75	2.38	3.00

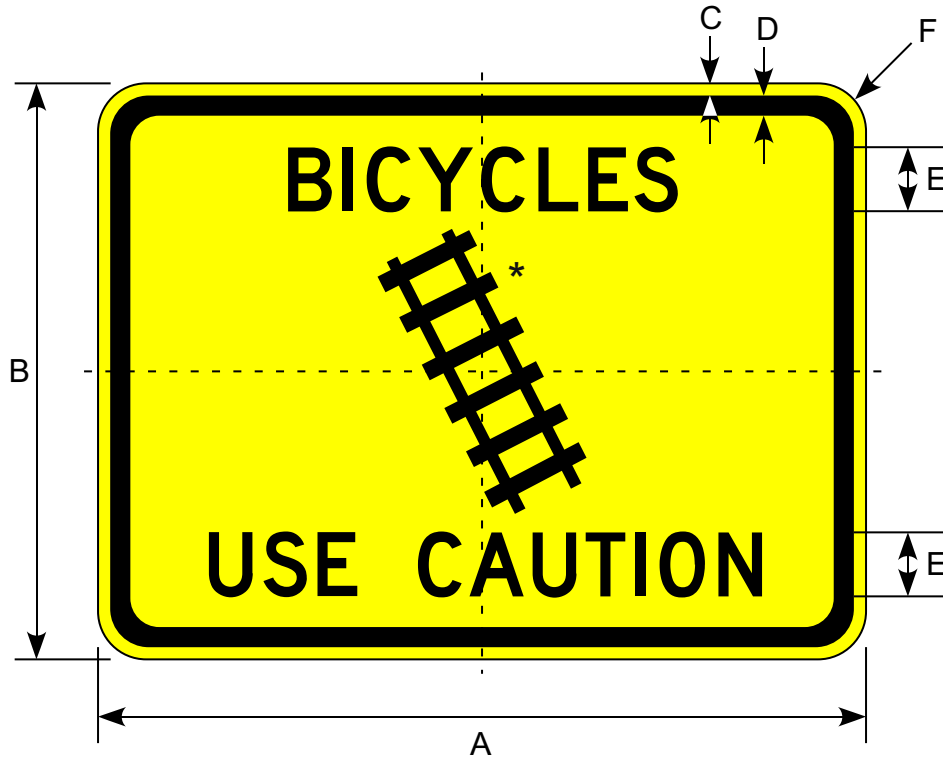

*Make symbol proportional to the graphic shown.

Border and Legend: Black
Background: Yellow

Road Class	Dimensions (inches)					
	A	B	C	D	E	F
Conventional	24	18	0.38	0.63	2D	1.5



Border and Legend: Black
 Background: Orange

Road Class	Dimensions (inches)										
	A	B	C	D	E	F	G	H	J	K	L
Conventional	72	48	0.75	1.25	6	5D	5	4	8D	5C	3

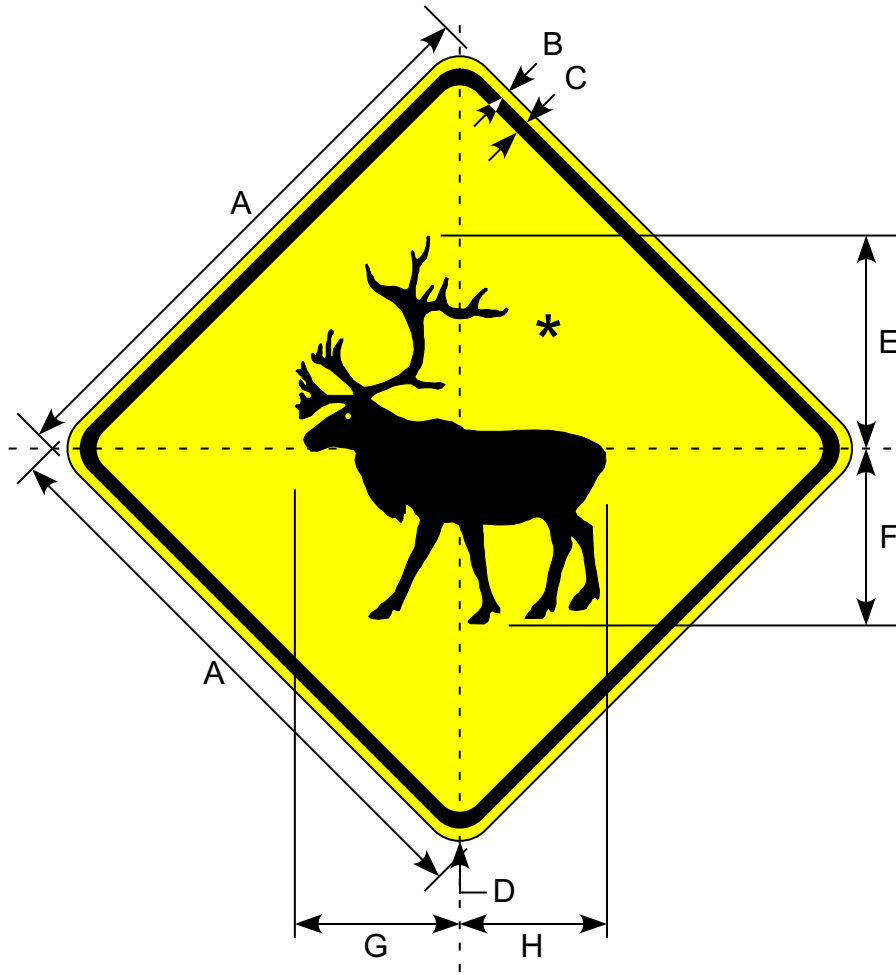

*Make symbol proportional to the graphic shown.

Border and Legend: Black
Background: Yellow

Road Class	Dimensions (inches)								
	A	B	C	D	E	F	G	H	
Minimum	30	0.50	0.75	1.88	13.31	9.25	8.63	7.69	
Conventional	36	0.63	0.88	2.25	16.00	11.06	10.31	9.20	
Expwy/Fwy	48	0.75	1.25	3.00	21.25	14.75	13.75	12.26	

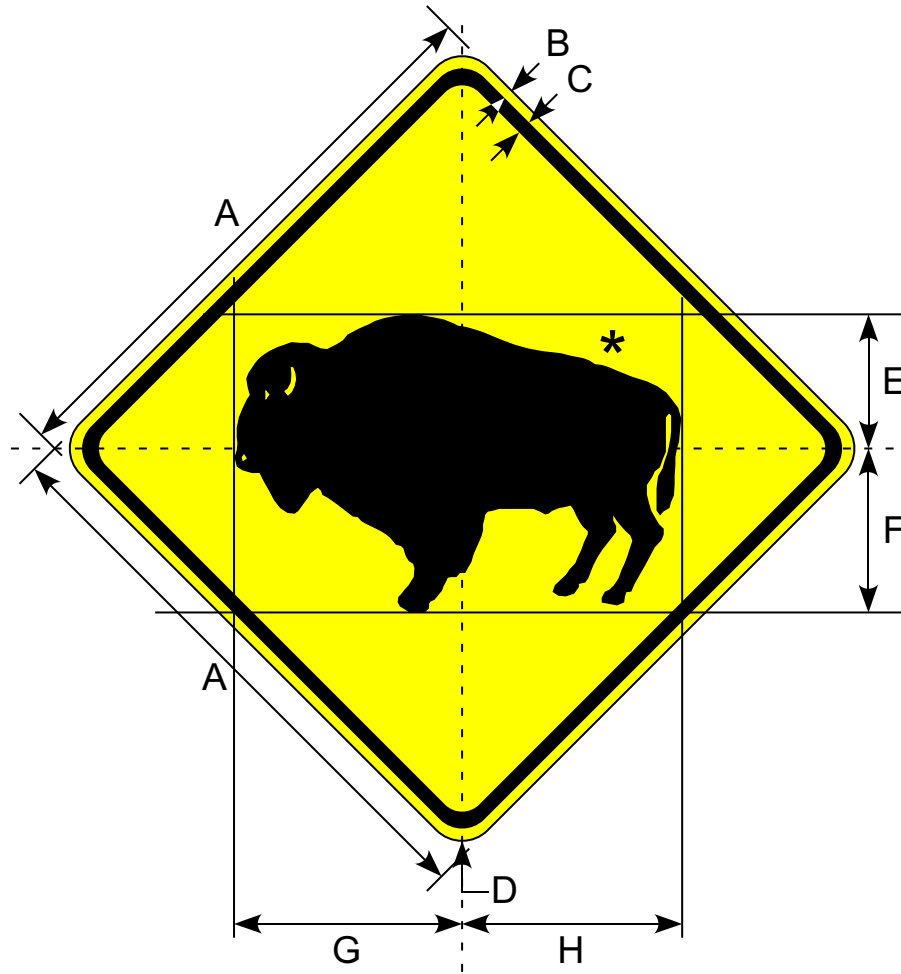

*Make symbol proportional to the graphic shown.

Border and Legend: Black
Background: Yellow

Road Class	Dimensions (inches)							
	A	B	C	D	E	F	G	H
Minimum	30	0.50	0.75	1.88	7.19	8.25	11.88	11.46
Conventional	36	0.63	0.88	2.25	8.38	10.25	14.25	13.75
Expwy/Fwy	48	0.75	1.25	3.00	11.63	13.63	19.00	18.33

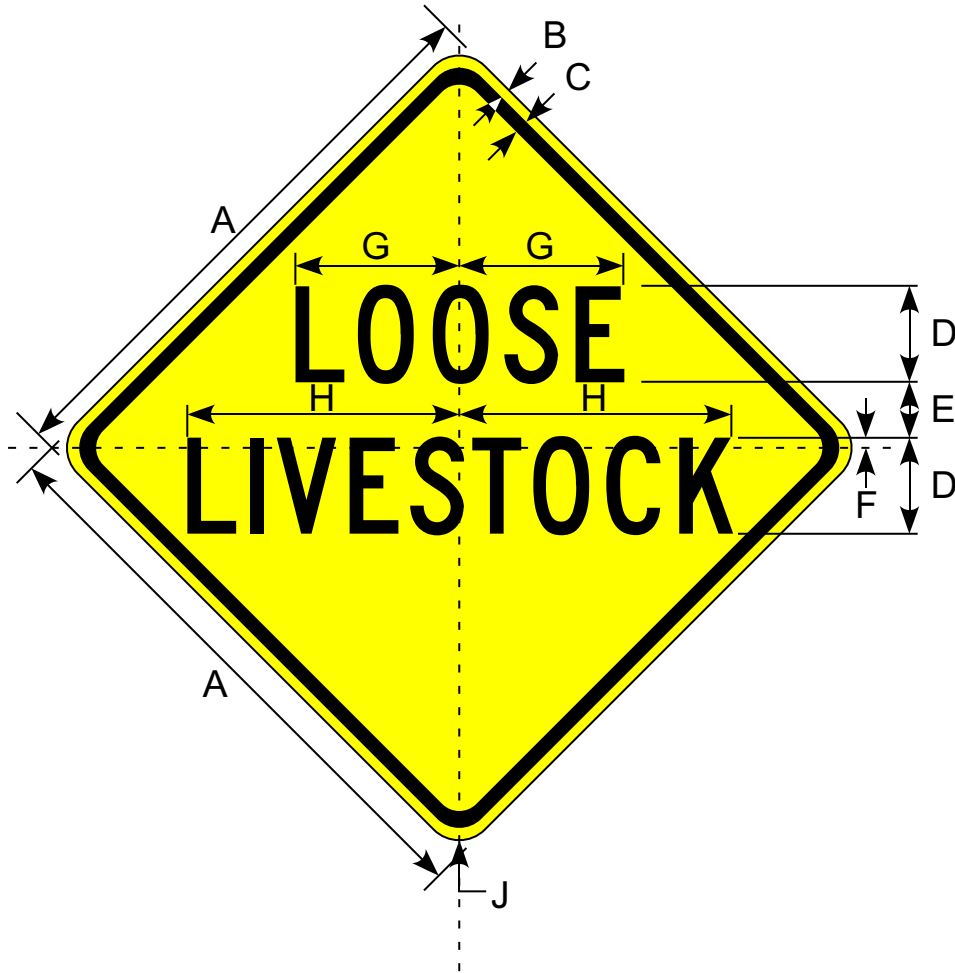

Border and Legend: Black
 Background: Yellow

Road Class	Dimensions (inches)								
	A	B	C	D	E	F	G	H	J
Minimum	30	0.50	0.75	4D	3.00	0.50	8.19	13.94	1.88
Conventional	36	0.63	0.88	6C	3.50	0.75	10.25	17.00	2.25

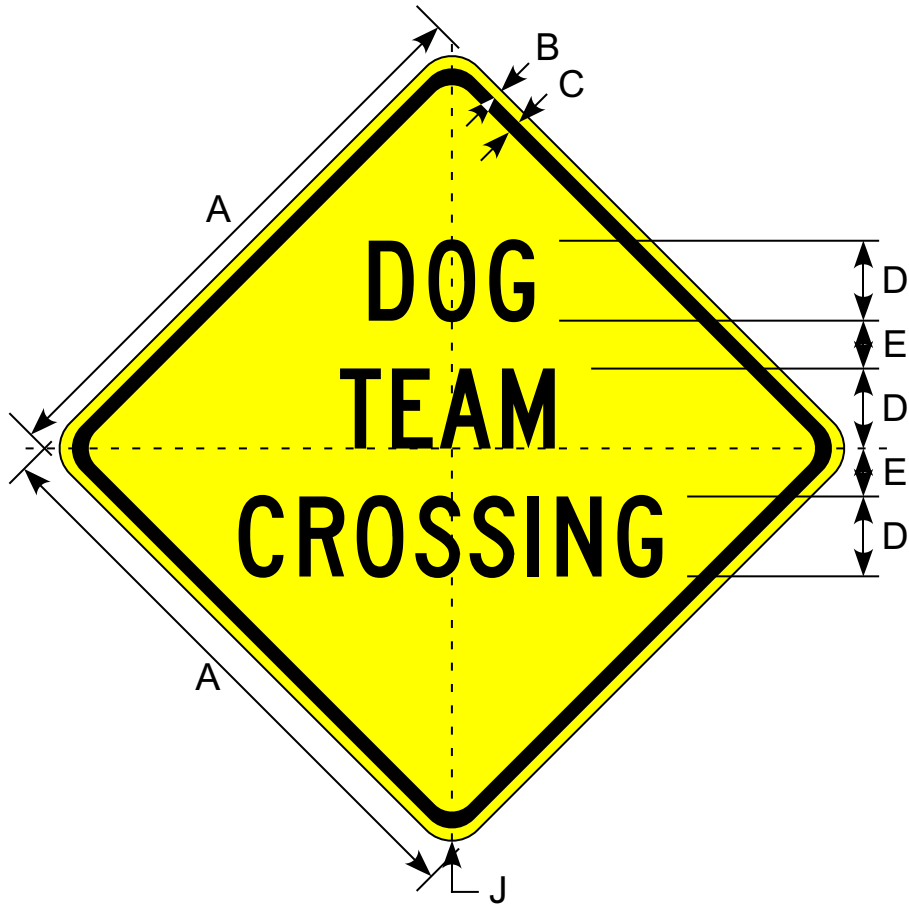

Border and Legend: Black
 Background: Yellow

Road Class	Dimensions (inches)					
	A	B	C	D	E	J
Minimum	30	0.50	0.75	4C	2.50	1.88
Conventional	36	0.63	0.88	5C	3.00	2.25



Border and Legend: Black
 Background: Yellow

* Reduce spacing by 14%.

Road Class	Dimensions (inches)							
	A	B	C	D	E	F	G	J
Conventional	24	18	0.38	0.63	5D	2	3	1.5

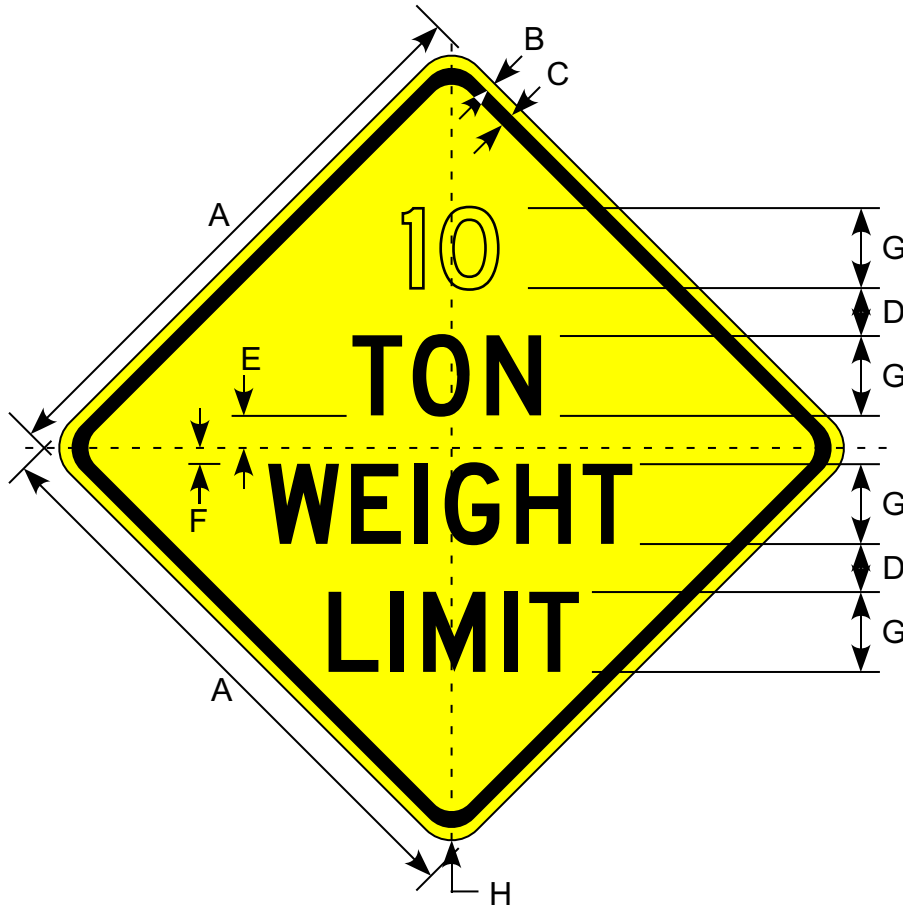

Border and Legend: Black
Background: Yellow

Road Class	Dimensions (inches)							
	A	B	C	D	E	F	G	H
Minimum	30	0.50	0.75	2.5	1.63	0.88	4D	1.88
Conventional	36	0.63	0.88	3.0	2.0	1.0	5D	2.25
Expwy/Fwy	48	0.75	1.25	4.0	2.63	1.38	6D	3.0

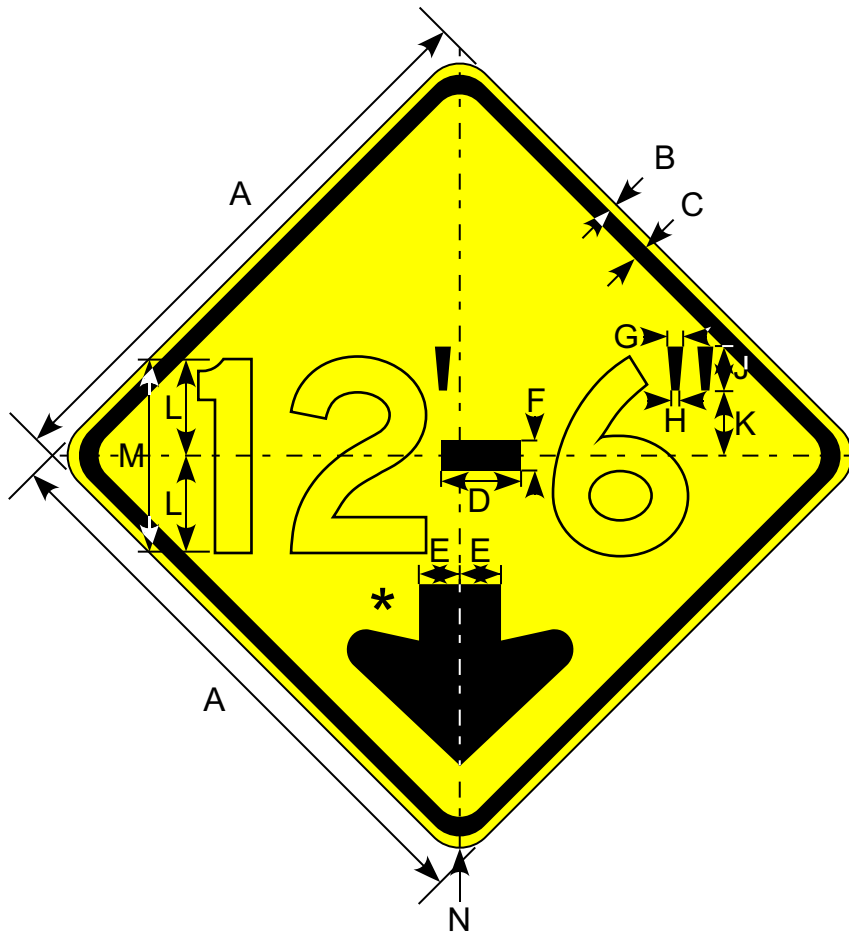

Border and Legend: Black
Background: Yellow

* See Appendix B-1 for Standard Arrow Details.

**If clearance height does not fit on sign
reduce letter series or height as necessary.

Road Class	Dimensions (inches)												
	A	B	C	D	E	F	G	H	J	K	L	M	N
Minimum	30	0.50	0.75	4.13	2.5	1.56	1.0	0.44	2.25	3.31	5.0	10D	1.88
Conventional	36	0.63	0.88	5.0	3.0	1.88	1.25	0.50	2.75	4.0	6.0	12D	2.25
Expwy/Fwy	48	0.75	1.25	6.56	4.0	2.44	1.63	0.63	3.63	5.5	8.0	16D	3.0

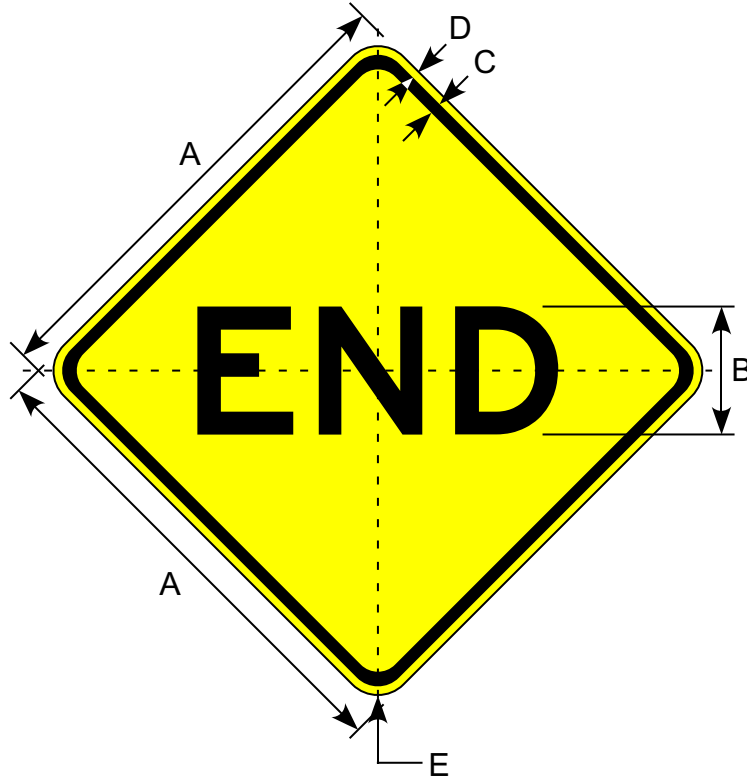

Border and Legend: Black
Background: Yellow

Road Class	Dimensions (inches)				
	A	B	C	D	E
Conventional	30	8E	0.75	0.5	2.25

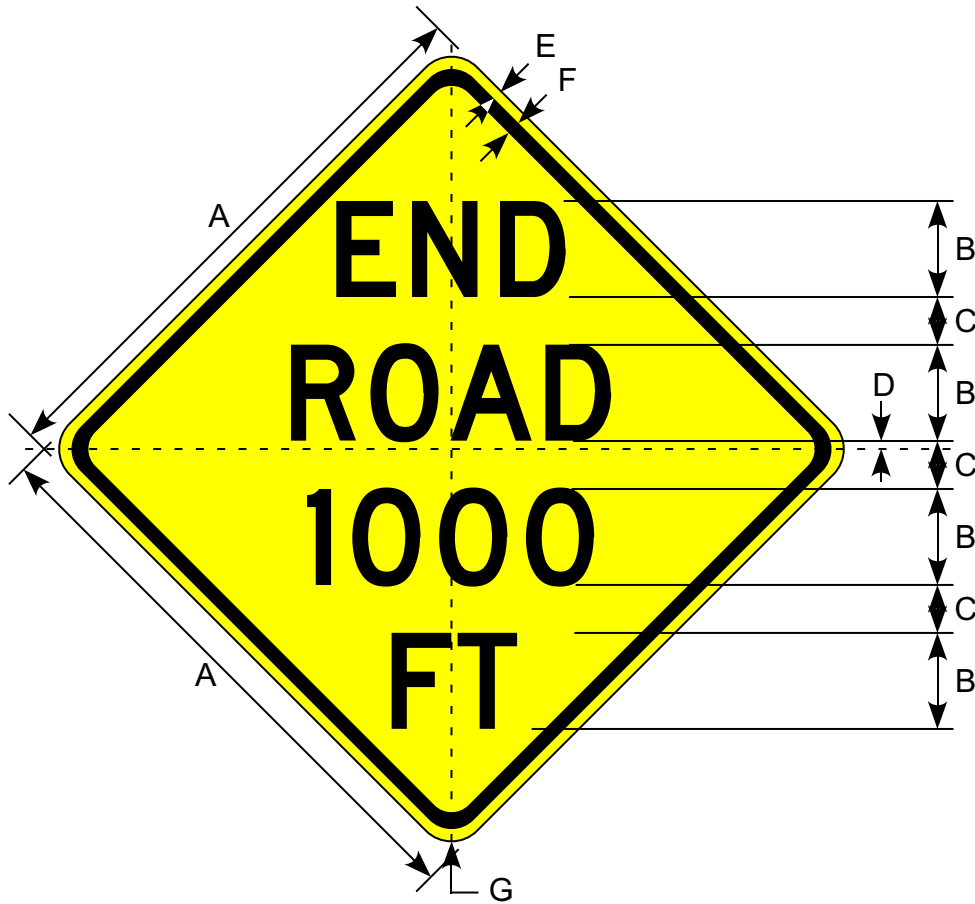

Border and Legend: Black
 Background: Yellow

Road Class	Dimensions (inches)						
	A	B	C	D	E	F	G
Minimum	30	5D	2.5	0.38	0.50	0.75	1.88
Conventional	36	6D	3.0	0.50	0.75	1.25	2.25

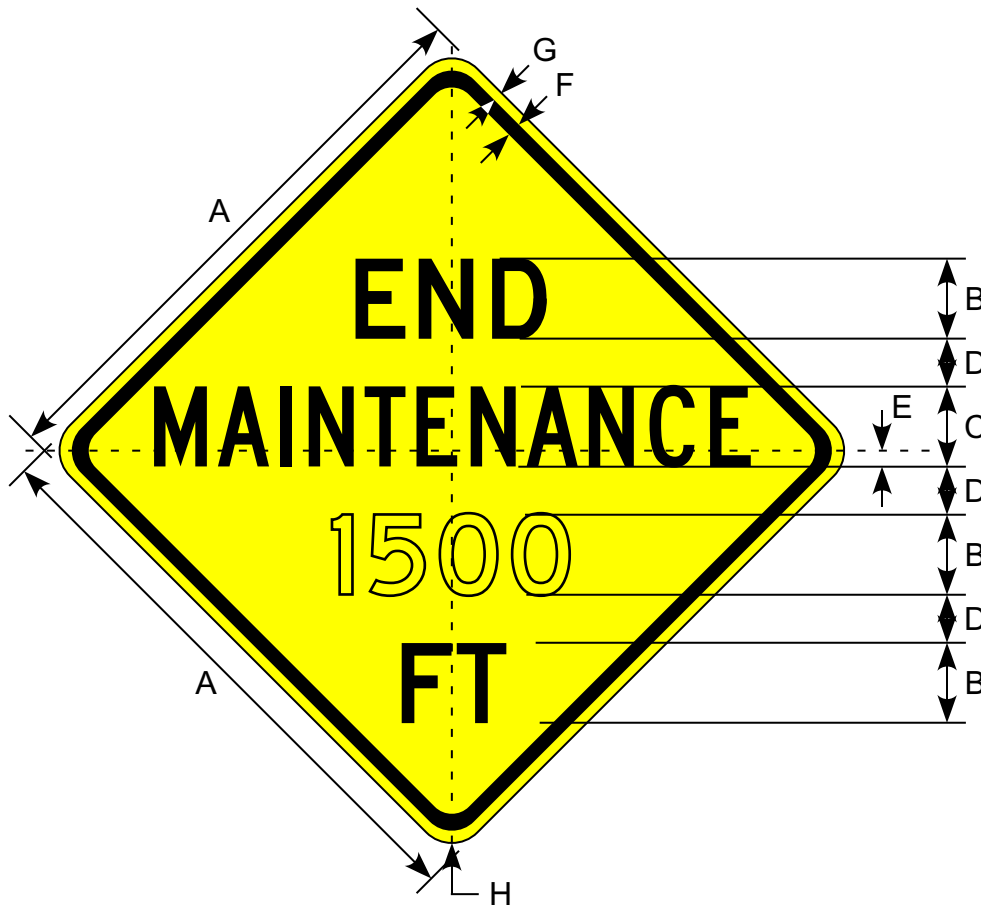

Border and Legend: Black
 Background: Yellow

Road Class	Dimensions (inches)							
	A	B	C	D	E	F	G	H
Minimum	30	4D	4C	2.75	0.88	0.75	0.50	1.88
Conventional	36	5D	5C	3.00	1.00	0.88	0.63	2.25

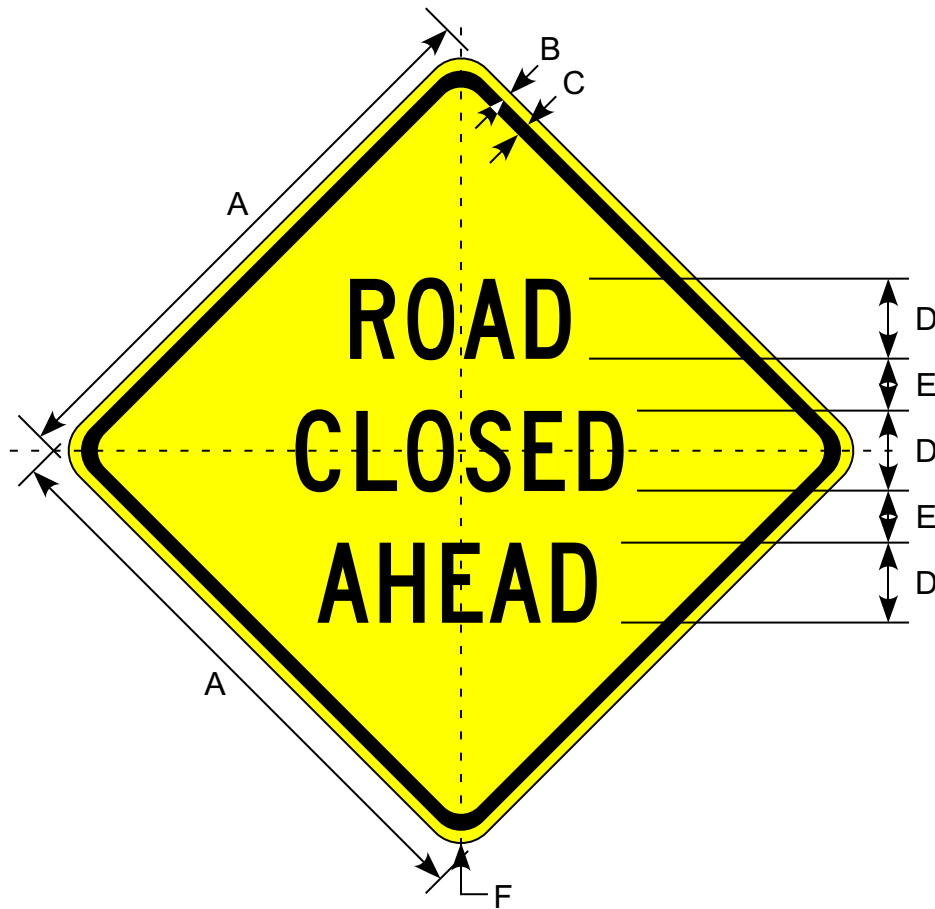

Border and Legend: Black
 Background: Yellow

Road Class	Dimensions (inches)					
	A	B	C	D	E	F
Minimum	30	0.50	0.75	4C	2.63	1.88
Conventional	36	0.63	0.88	5C	3.25	2.25
Expwy/Fwy	48	0.75	1.25	6C	4.00	3.00

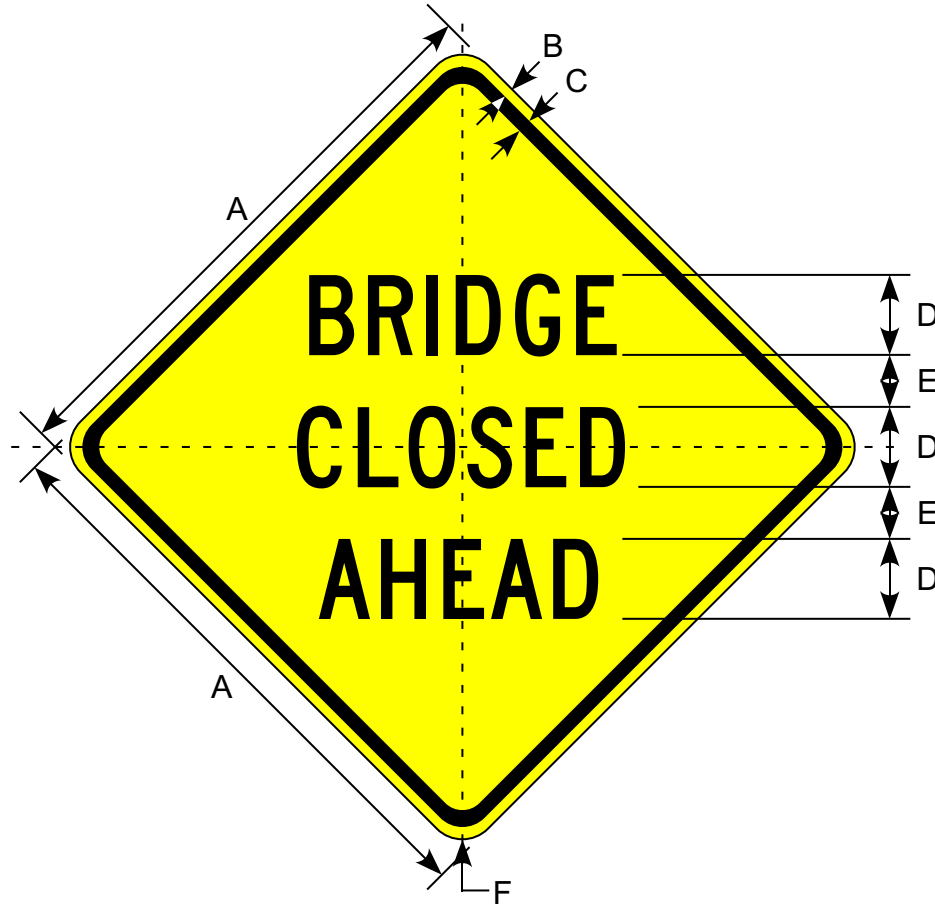

Border and Legend: Black
Background: Yellow

Road Class	Dimensions (inches)					
	A	B	C	D	E	F
Minimum	30	0.50	0.75	4C	2.63	1.88
Conventional	36	0.63	0.88	5C	3.25	2.25
Expwy/Fwy	48	0.75	1.25	6C	4.00	3.00

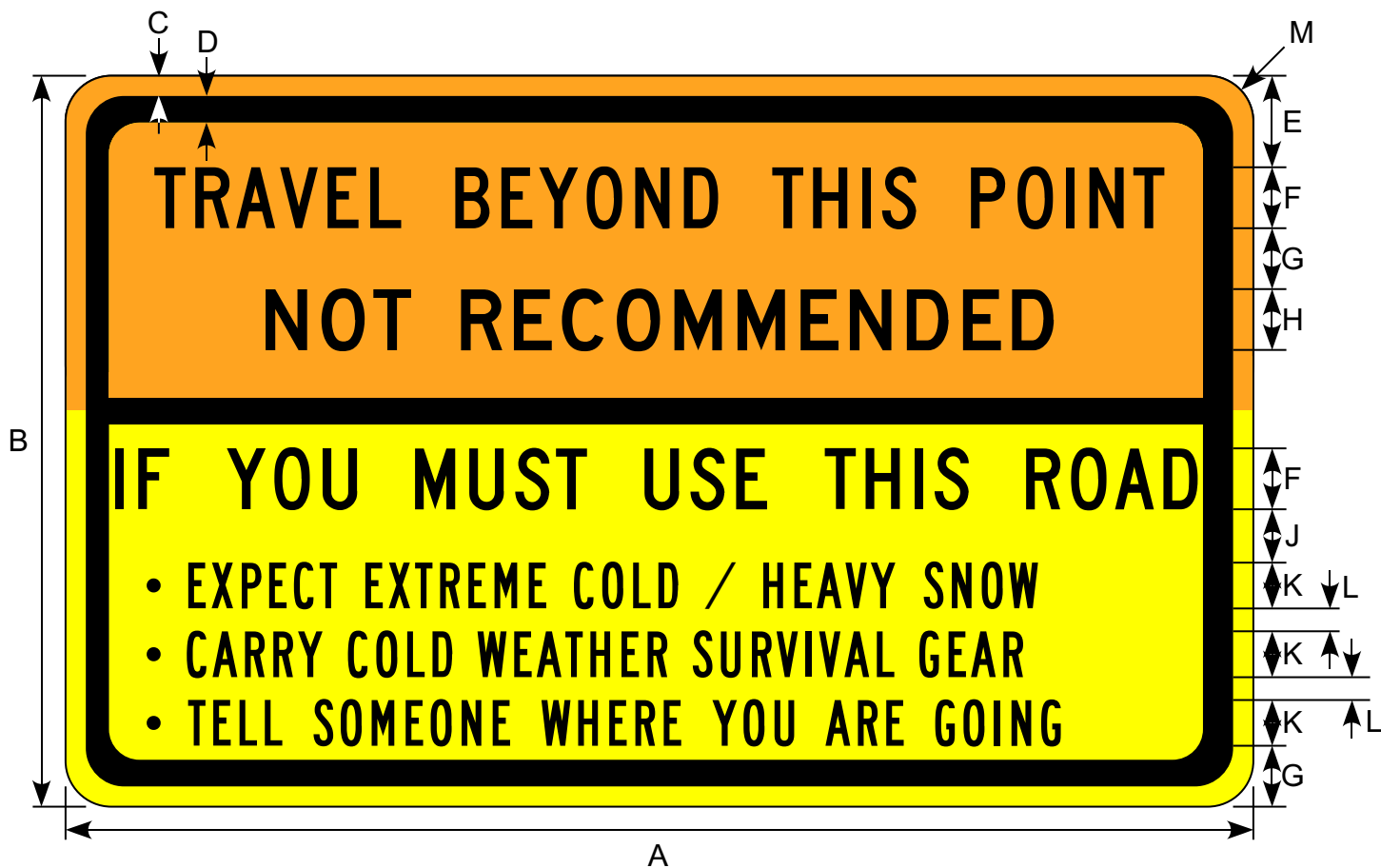

Border and Legend: Black
 Upper Background: Orange
 Lower Background: Yellow

Road Class	Dimensions (inches)												
	A	B	C	D	E	F	G	H	J	K	L	M	
Conv & Min	78	48	1.33	1.75	6	4C	4	4D	3.5	3B	1.5	3	

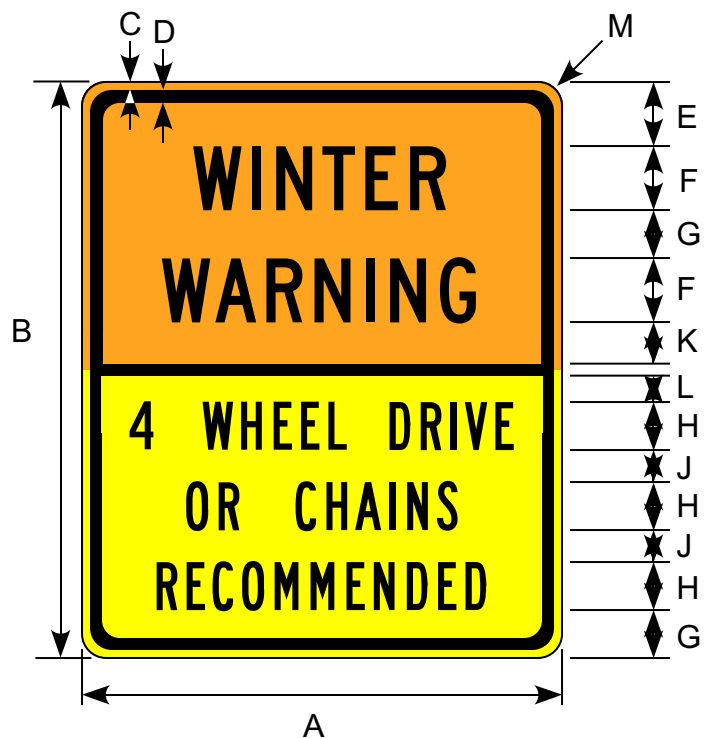

Border and Legend: Black
 Upper Background: Orange
 Lower Background: Yellow

Road Class	Dimensions (inches)												
	A	B	C	D	E	F	G	H	J	K	L	M	
Conv & Min	30	36	0.50	0.75	4	4C	3	3B	2.0	2.60	1.65	1.5	

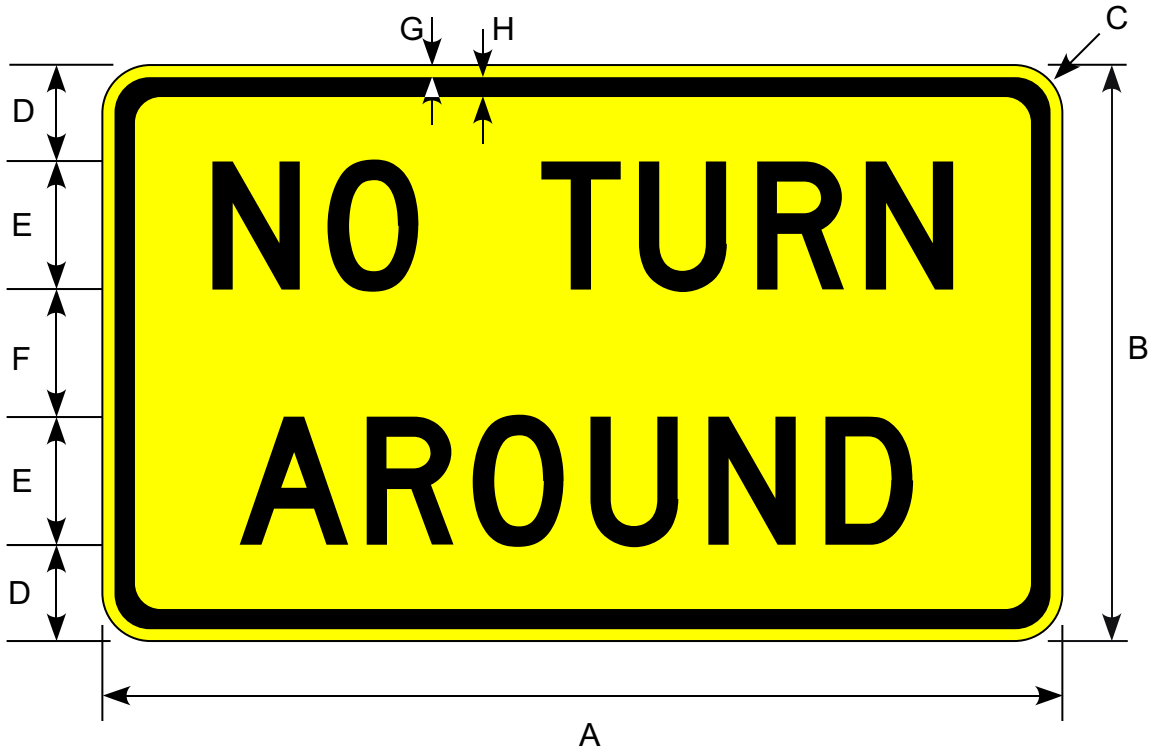

Border and Legend: Black
Background: Yellow

Class	A	B	C	D	E	F	G	H
Conv & Min	30	18	1.5	3	4D	4	0.38	0.63

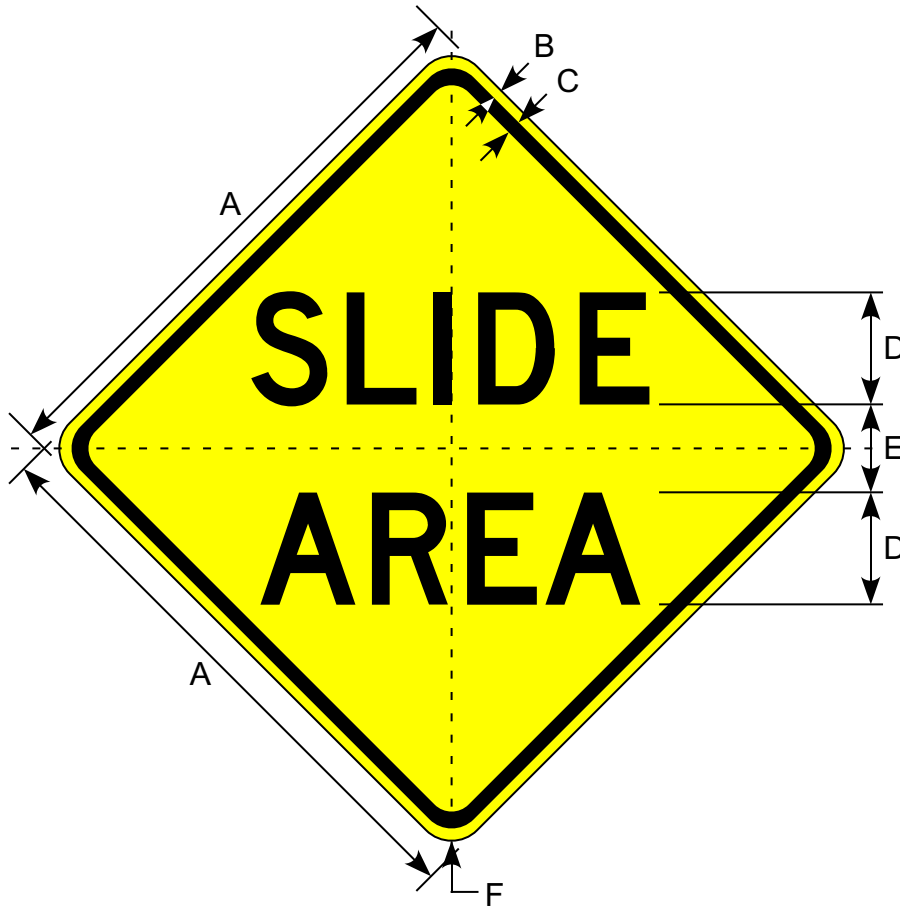

Border and Legend: Black
Background: Yellow

Road Class	Dimensions (inches)					
	A	B	C	D	E	F
Minimum	30	0.5	0.75	6D	4.5	1.88
Conventional	36	0.63	0.88	7D	5.5	2.25
Expressway	48	0.75	1.25	10D	7.0	3.00

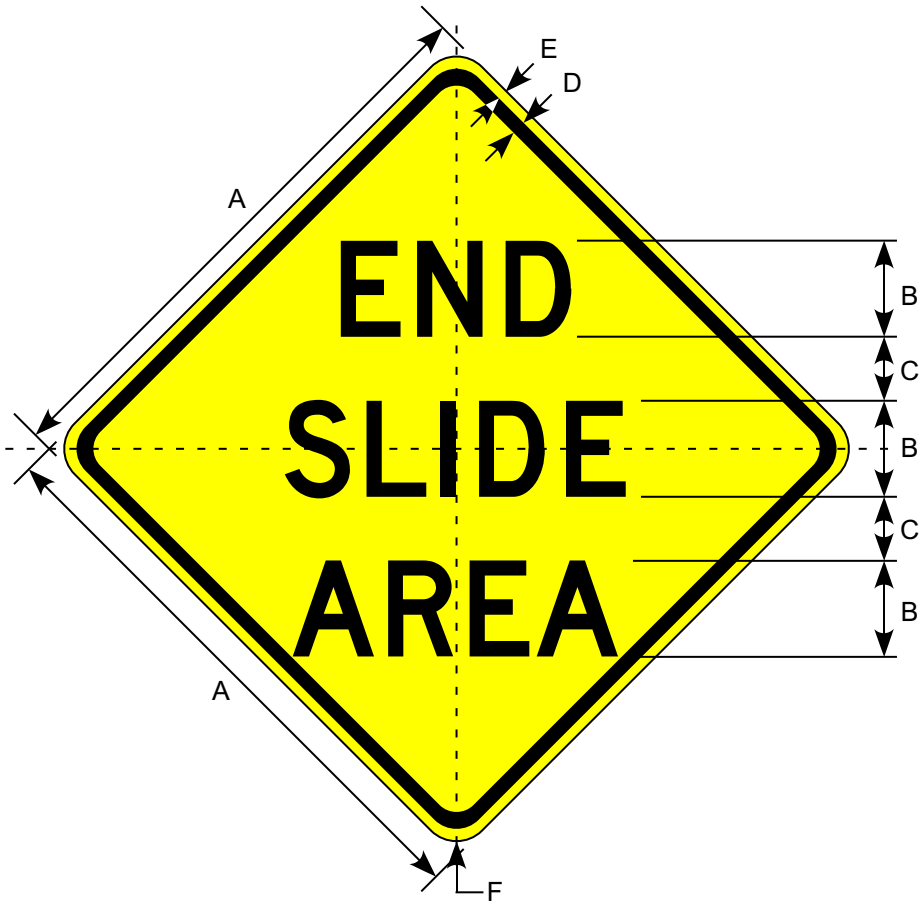

Border and Legend: Black
 Background: Yellow

Road Class	Dimensions (inches)					
	A	B	C	D	E	F
Minimum	30	5D	3.31	0.75	0.50	1.88
Conventional	36	6D	4.00	0.88	0.63	2.25
Expwy/Fwy	48	8D	5.31	1.25	0.75	3.00

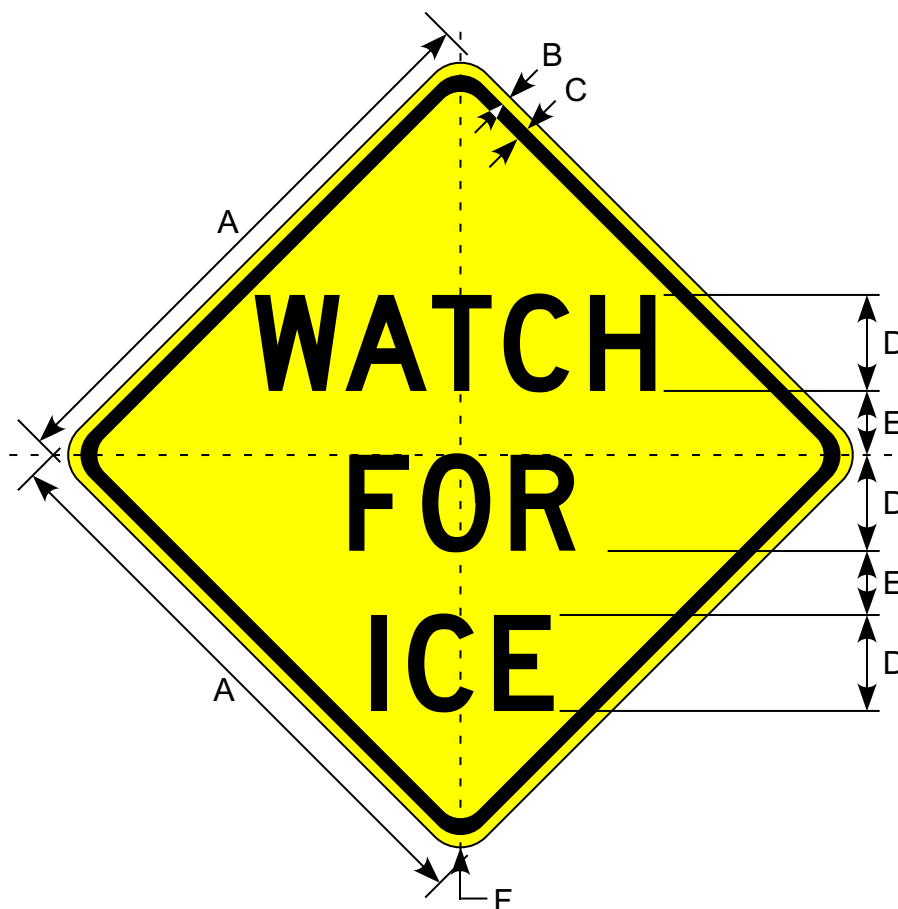

Border and Legend: Black
Background: Yellow

Road Class	Dimensions (inches)					
	A	B	C	D	E	F
Minimum	30	0.50	0.75	5D	3.00	1.88
Conventional	36	0.63	0.88	6D	4.00	2.25
Expwy/Fwy	48	0.75	1.25	8D	5.25	3.00



Border and Legend: Black
 Background: Yellow

Road Class	Dimensions (inches)					
	A	B	C	D	E	F
Minimum	30	0.50	0.75	4D	1.25	1.88
Conventional	36	0.63	0.88	5D	1.75	2.25
Expwy/Fwy	48	0.75	1.25	7D	2.25	3.00

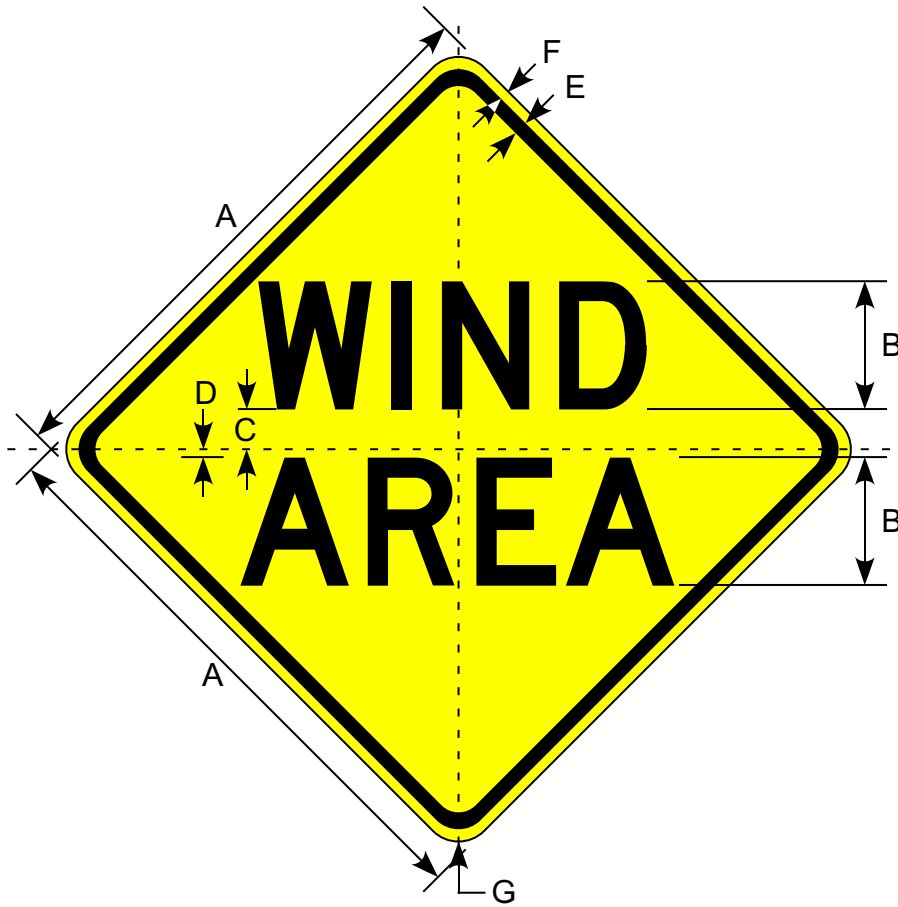

Border and Legend: Black
 Background: Yellow

Road Class	Dimensions (inches)						
	A	B	C	D	E	F	G
Minimum	30	6D	2.13	0.38	0.75	0.50	1.88
Conventional	36	8D	2.50	0.50	0.88	0.63	2.25
Expwy/Fwy	48	10D	3.00	0.75	1.25	0.75	3.00

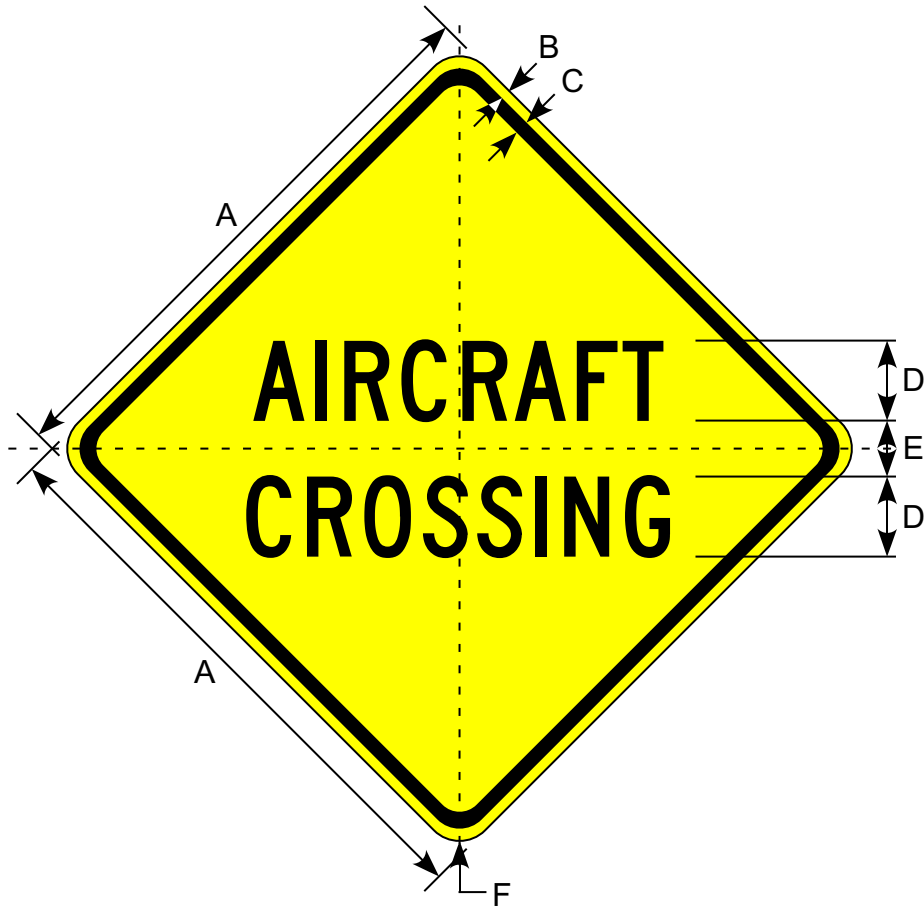

Border and Legend: Black
Background: Yellow

Road Class	Dimensions (inches)					
	A	B	C	D	E	F
Minimum	30	0.50	0.75	4C	3.00	1.88
Conventional	36	0.63	0.88	5C	3.50	2.25
Expwy/Fwy	48	0.75	1.25	7C	4.50	3.00

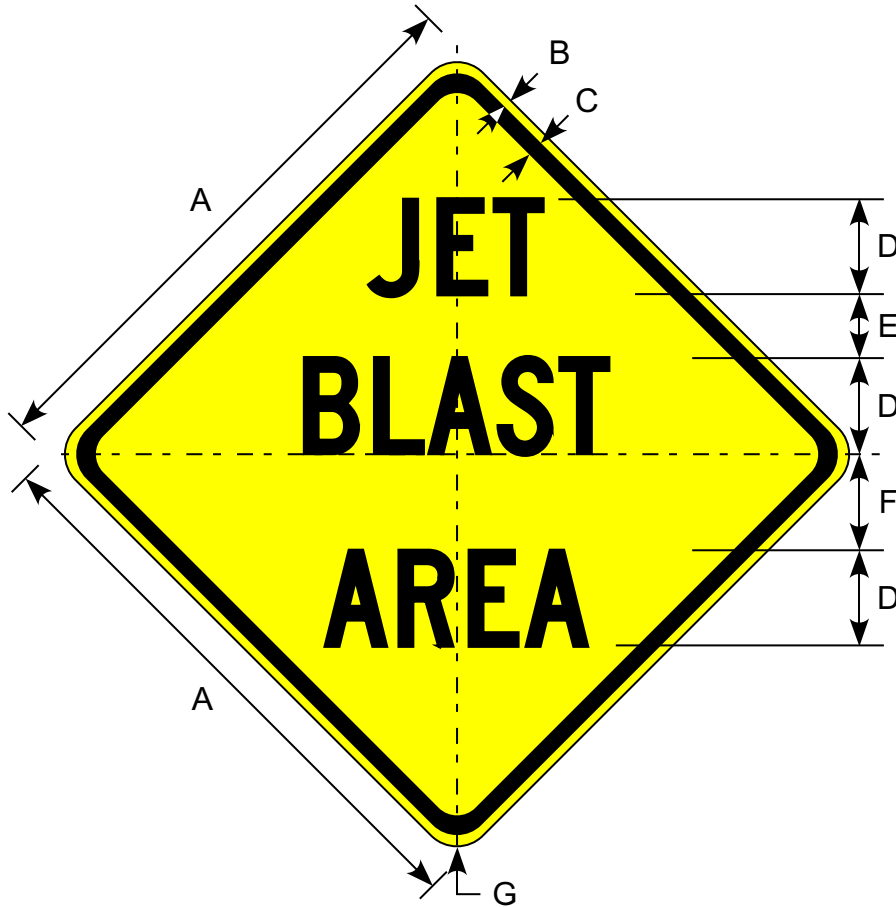

Border and Legend: Black
 Background: Yellow

Road Class	Dimensions (inches)						
	A	B	C	D	E	F	G
Minimum	30	0.50	0.75	5C	3.3	5.0	1.88
Conventional	36	0.63	0.88	6C	4.0	6.0	2.25
Expwy/Fwy	48	0.75	1.25	8C	6.0	8.0	3.0

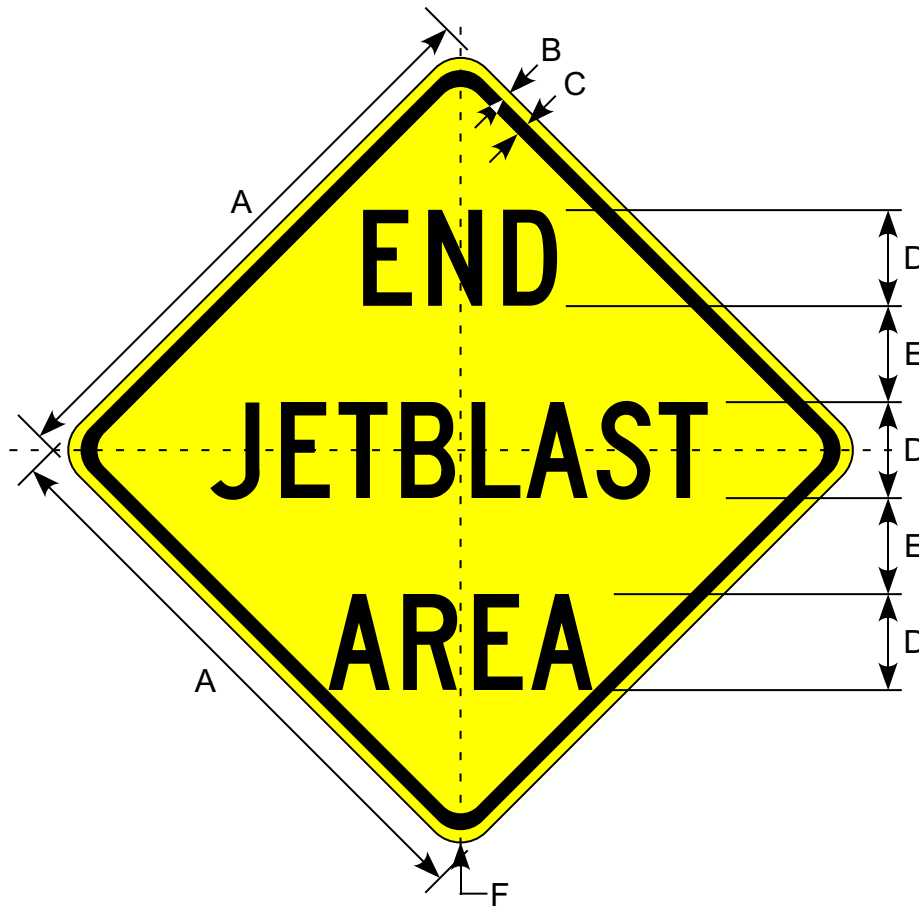

Border and Legend: Black
 Background: Yellow

Road Class	Dimensions (inches)					
	A	B	C	D	E	F
Minimum	30	0.50	0.75	5C	5.0	1.88
Conventional	36	0.63	0.88	6C	6.0	2.25
Expwy/Fwy	48	0.75	1.25	8C	8.0	3.0

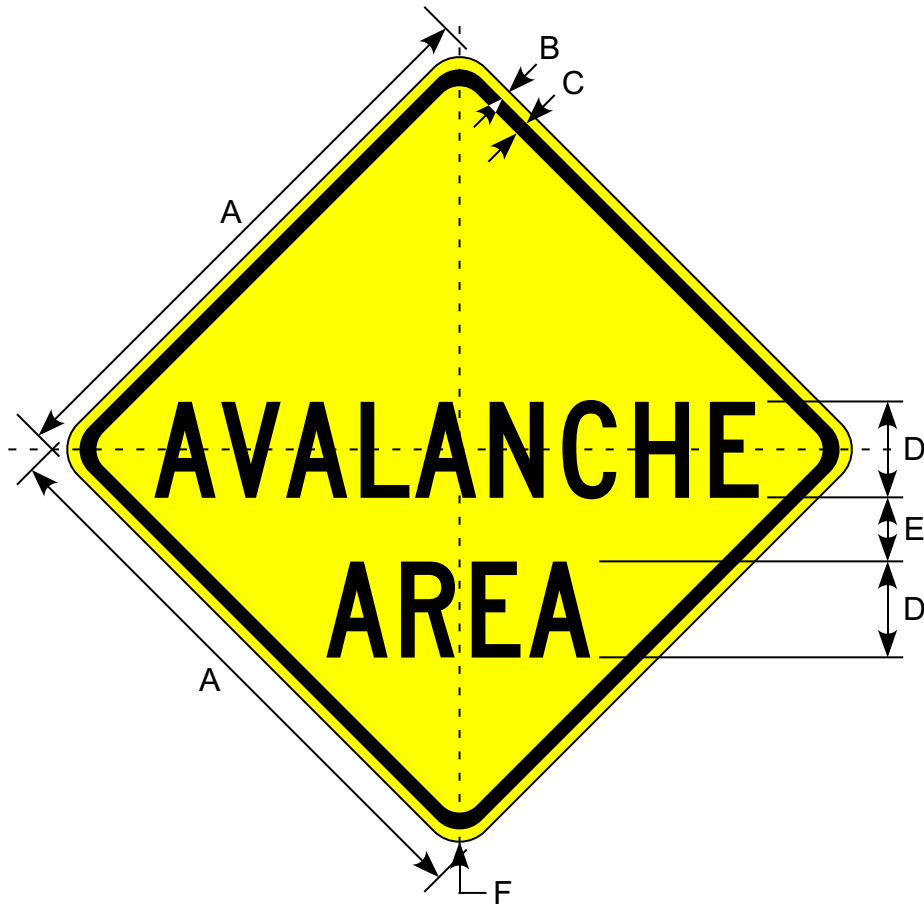

Border and Legend: Black
 Background: Yellow

Road Class	Dimensions (inches)					
	A	B	C	D	E	F
Minimum	30	0.50	0.75	5C	3.5	1.88
Conventional	36	0.63	0.88	6C	4.0	2.25
Expwy/Fwy	48	0.75	1.25	8C	5.38	3.0

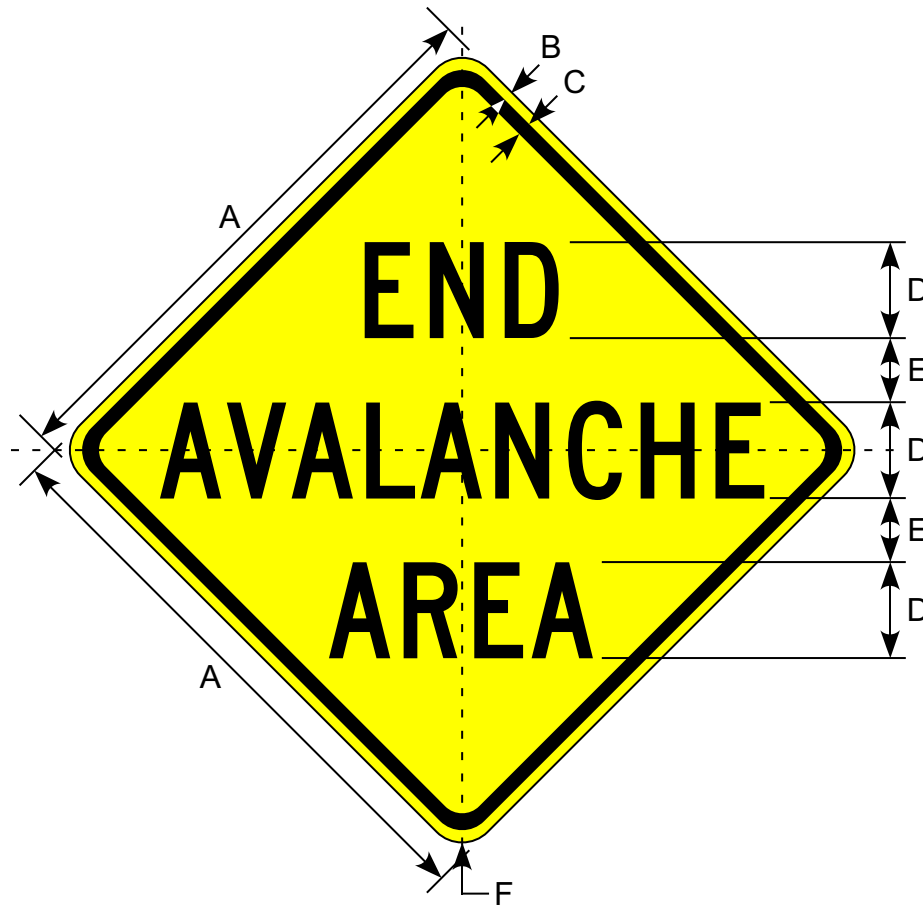

Border and Legend: Black
Background: Yellow

Road Class	Dimensions (inches)					
	A	B	C	D	E	F
Minimum	30	0.50	0.75	5C	3.0	1.88
Conventional	36	0.63	0.88	6C	4.0	2.25
Expwy/Fwy	48	0.75	1.25	8C	5.25	3.0

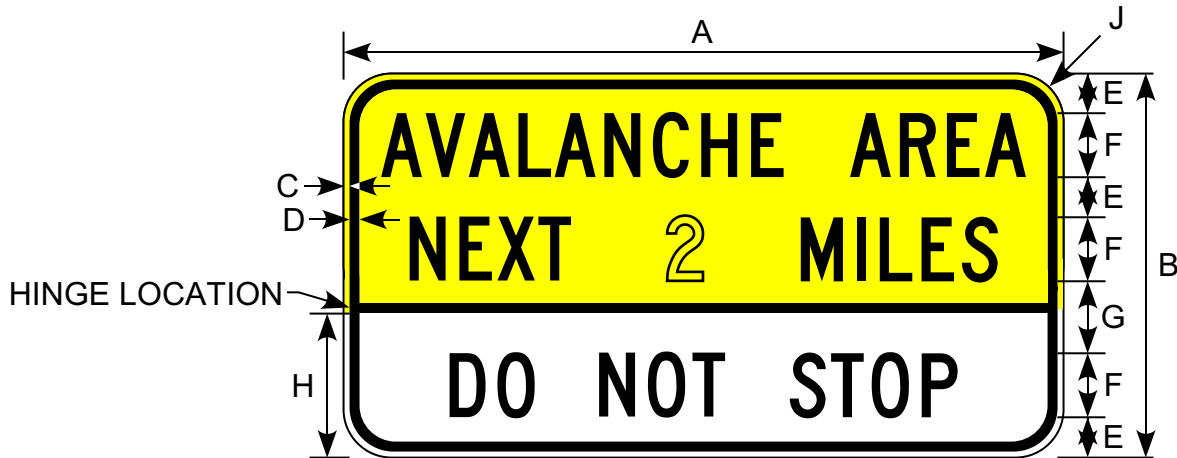

Border and Legend: Black
 Background Top: Yellow
 Background Bottom: White

Road Class	Dimensions (inches)								
	A	B	C	D	E	F	G	H	J
Expwy/Fwy	90	48	0.75	1.25	5	8C	9	18	6



Border and Legend: Black
Background: Yellow

Class	A	B	C	D	E	F	G	H
Min & Conv	30	36	0.5	0.75	4D	2.50	3	1.88

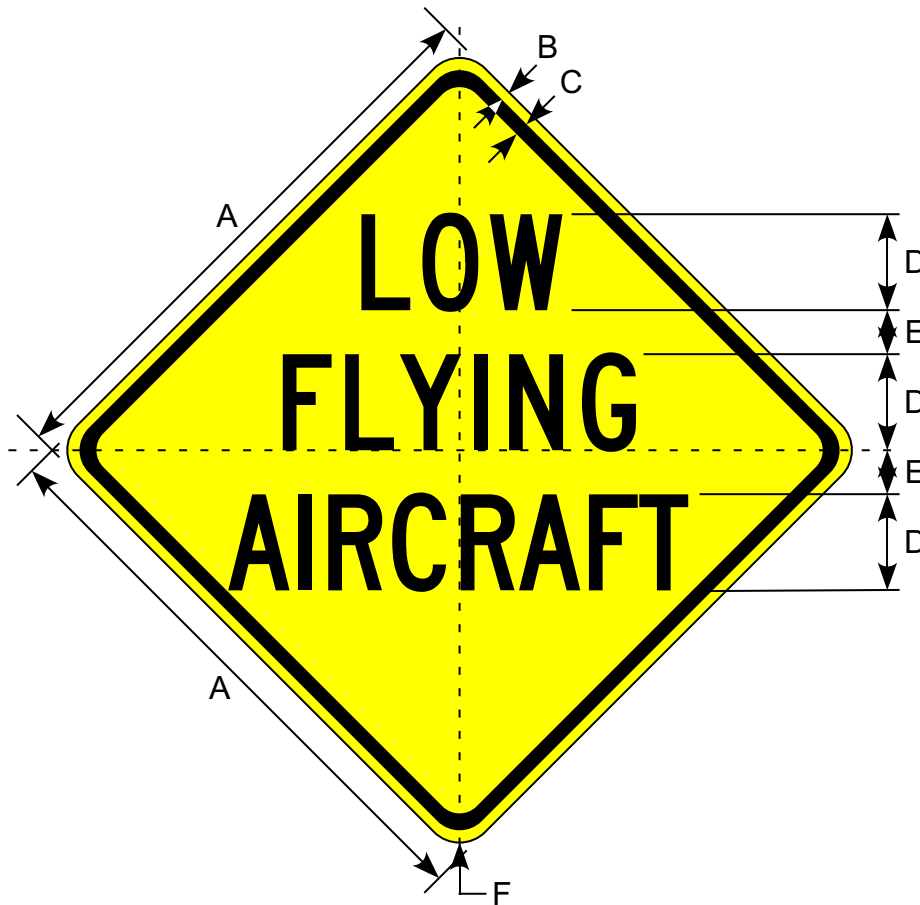

Border and Legend: Black
Background: Yellow

Road Class	Dimensions (inches)					
	A	B	C	D	E	F
Minimum	30	0.50	0.75	5C	2.5	1.88
Conventional	36	0.63	0.88	6C	2.75	2.25
Expwy/Fwy	48	0.75	1.25	8C	3.5	3.0

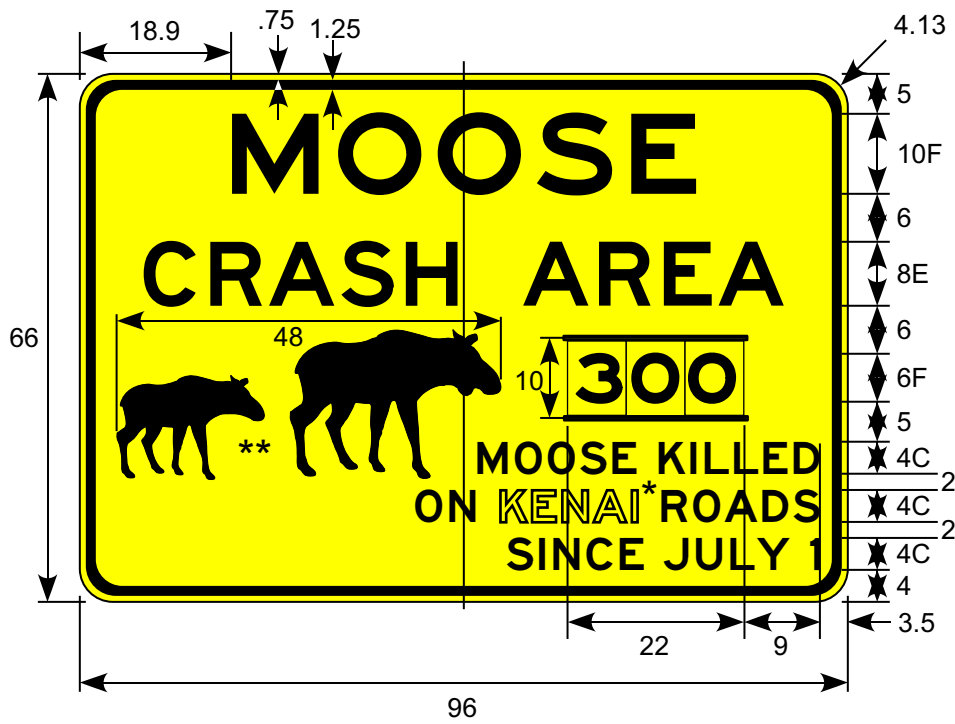

* or other road

** Make symbol proportional to the graphic shown.

Border and Legend: Black
 Background: Yellow
 Digit Insert Background: White

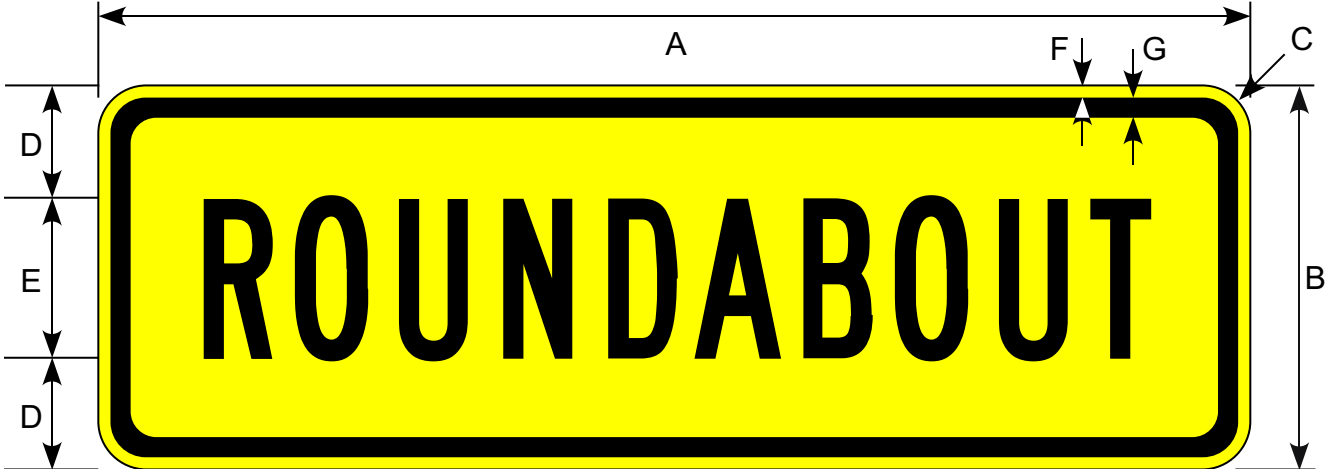

Border and Legend: Black
 Background: Yellow

Road Class	Dimensions (inches)						
	A	B	C	D	E	F	G
Conv & Min	36	12	1.5	3.5	5B	0.38	0.63
Expressway	48	12	2.0	3.0	6B	0.38	0.63

W23-100 (Front)

STOP-SLOW PADDLE *

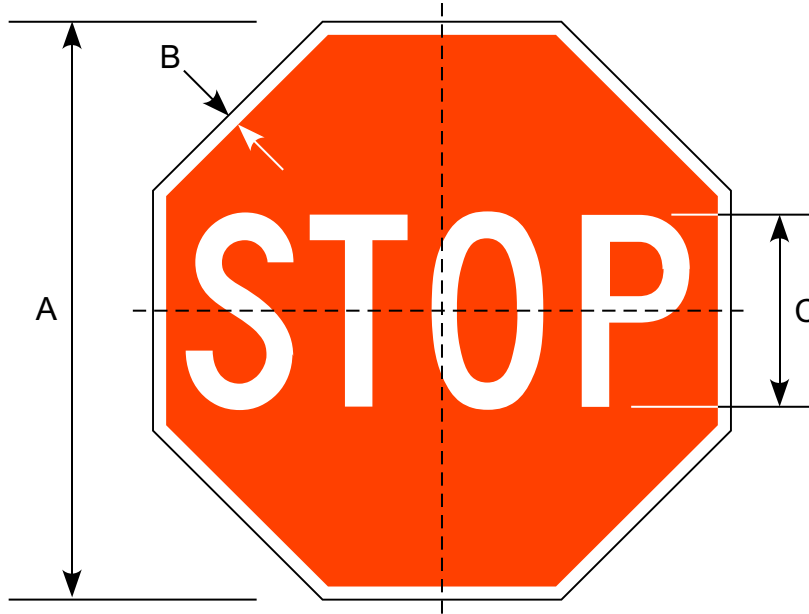

Border and Legend: White
Background: Red

Road Class	Dimensions (inches)		
	A	B	C
Local Rds w Spd Limits <= 25MPH	18	0.38	6C
All Other Roads	24	0.63	8C

W23-100 (Back)

STOP-SLOW PADDLE *

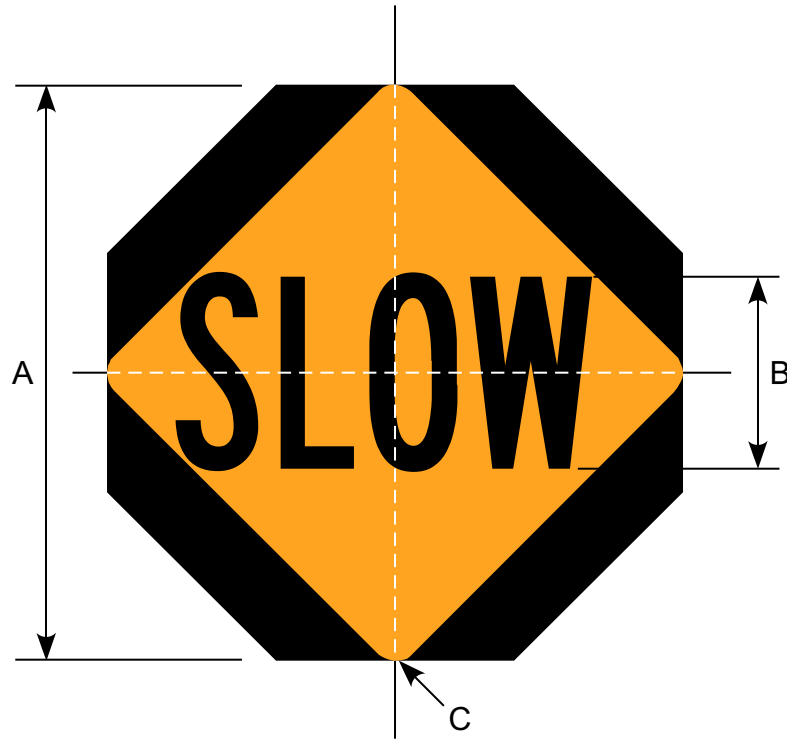

Legend: Black
Background: Orange
Area Outside Diamond: Black

Road Class	Dimensions (inches)		
	A	B	C
Local Rds w Spd Limits ≤ 25 MPH	18	6B	1.0
All Other Roads	24	7B	1.25