

CEER-S-178

VARIABLE GEOMETRY DARRIEUS WIND MACHINE

J.T. PYTLINSKI AND D. SERRANO



CENTER FOR ENERGY AND ENVIRONMENT RESEARCH  
UNIVERSITY OF PUERTO RICO — U.S. DEPARTMENT OF ENERGY

VARIABLE GEOMETRY DARRIEUS WIND MACHINE

J. T. Pytlinski\* and D. Serrano\*\*

Center for Energy and Environment Research  
University of Puerto Rico  
Mayaguez, Puerto Rico 00708

ABSTRACT

A new variable geometry Darrieus wind machine is proposed. The lower attachment of the blades to the rotor can move freely up and down the axle allowing the blades to change shape during rotation. Experimental data for a 17 m diameter Darrieus rotor and a theoretical model for multiple streamtube performance prediction were used to develop a computer simulation program for studying parameters that affect the machine's performance. New structural and dynamic parameters were incorporated into the program and varied in order to simulate the machine's operation in a wide range of aerodynamic conditions. In computations a parabolic blade was used to approximate a true troposkein shape. This new variable geometry concept is described and interrelated with multiple streamtube theory through aerodynamic parameters. The computer simulation study shows that governor behavior of a Darrieus turbine can not be attained by a standard turbine operating within normally occurring rotational velocity limits. These results are illustrated graphically and numerically. A second generation variable geometry Darrieus wind turbine which uses a telescopic blade is proposed as a potential improvement on the studied concept.

KEYWORDS

Wind power; vertical-axis wind turbine; Darrieus wind turbine of variable geometry; theoretical analysis; computer simulation results.

---

\*Head and Senior Scientist, Solar Division  
\*\*Graduate Student

## INTRODUCTION

The Frenchman G. J. M. Darrieus patented in the United States in 1931 a wind machine characterized by a vertical axis of rotation and curved blades attached to the rotor at two ends. The Darrieus machine was reintroduced again in the mid-1960's by researchers of the National Research Council of Canada (NRC). Since then theoretical aspects of Darrieus turbine operation have been studied in detail by NRC and Sandia Laboratories in the United States. Their research has shown that the machine has aerodynamic characteristics which in some respects differ from those of other wind machines; that it has a greater energy output per unit of mass than many other wind machines; and, that it is easily adaptable not only for electrical power generation, but also for a wide range of mechanical applications.

The Darrieus machine differs by several features from conventional windmills which rotate about a horizontal axis. The turbine, which is usually composed of two or three blades, is omnidirectional and accepts wind from any direction without yawing. Since the blades' axle is held vertically by guy cables, the turbine does not need to be placed on a tower to keep the blades high above the ground. Moreover, the generator and gear train do not need to be elevated and are mounted on the ground. These features simplify the maintenance and repair of the machine components.

Yet, the Darrieus wind machine is not self-starting. Its fixed-pitch blades stall at low speeds and they cannot be depended upon to drive the turbine from a standstill. To operate the Darrieus machine as self-starting, one or two Savonius rotors are mounted on the center shaft to propel the turbine at low wind speeds, or an auxiliary motor provides a starting torque. The Darrieus machines usually operate at constant rev/min by being connected to a utility grid through a synchronous generator.

The Darrieus turbine uses lift as a driving force and is considerably more efficient than drag turbines such as the Savonius. It is, however, generally less efficient than propeller driven wind machines. Darrieus wind machines ranging from a few kilowatts to 250 kW are used, instead of diesel engines, to pump water and generate electric power in remote locations of Canada, the United States, Australia, New Zealand, Argentina and other countries. Research is being done to improve the aerodynamic performance of the turbine and to develop machines in the megawatt range.

## NEW VARIABLE GEOMETRY DARRIEUS WIND TURBINE

In a standard Darrieus turbine, the tip to speed ratio<sup>1</sup> varies along the rotor blade from a peak near the blade mid-point to near zero where the blade joins the torque axle. Consequently

---

<sup>1</sup> The ratio of the blade tip speed to wind speed.

this ratio cannot be optimal along the entire length of the blade. The turbine geometry results from the shape imposed on blades that are permanently attached at both ends during a wide range of aerodynamic conditions and that are shaped to minimize bending stress. In a standard turbine the blade is curved like a free-spinning rope or troposkein that would allow centrifugal forces to act throughout the length of the blade. In practice, however, the blades do not assume a troposkein shape. During rotation factors imposed on the machine such as energy output per unit of mass, tip to speed ratio, aspect ratio<sup>2</sup> and solidity<sup>3</sup> determine the shape of the blade during rotation. In a variable geometry turbine, however, the blades assume a shape imposed by the turbine operation conditions and by the centrifugal forces acting on the blades. In a standard turbine and in a variable geometry turbine the blades are fixed in pitch. In both, the blades have the same cross section from one end to the other. Therefore, they can be extruded and mass-produced.

Figure 1 shows a conceptual drawing of the new variable geometry Darrieus wind turbine. In this turbine the lower attachment of the blades to the rotor axle is free to move up and down.

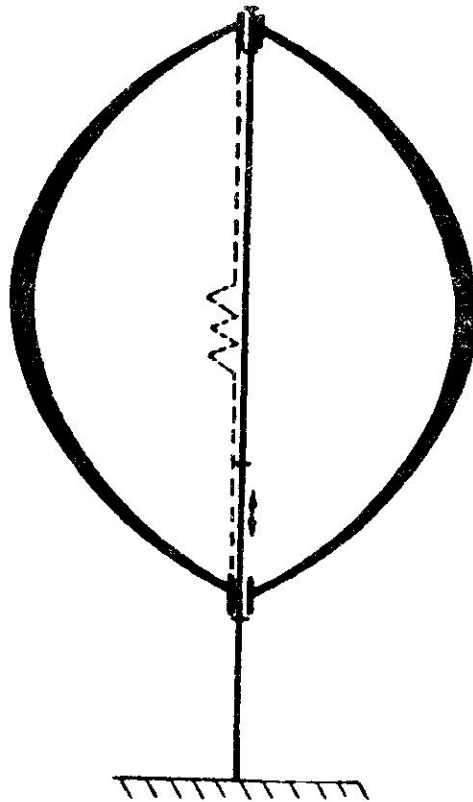

Fig. 1. New variable geometry Darrieus wind turbine with structural spring.

<sup>2</sup> The ratio of the turbine height to its diameter.

<sup>3</sup> The ratio of the blade area to area swept by turbine.

This motion occurs because of variations in the turbine angular velocity caused by different wind conditions and the subsequent variation of the turbine moment of inertia. Centrifugal force bends the blades into geometrical shapes imposed by the aerodynamic conditions of the turbine operation. Two concepts were investigated: in the first concept, the blades themselves act as a structural spring as shown in Fig. 1; in the second concept, an external spring is added as shown in Fig. 2.

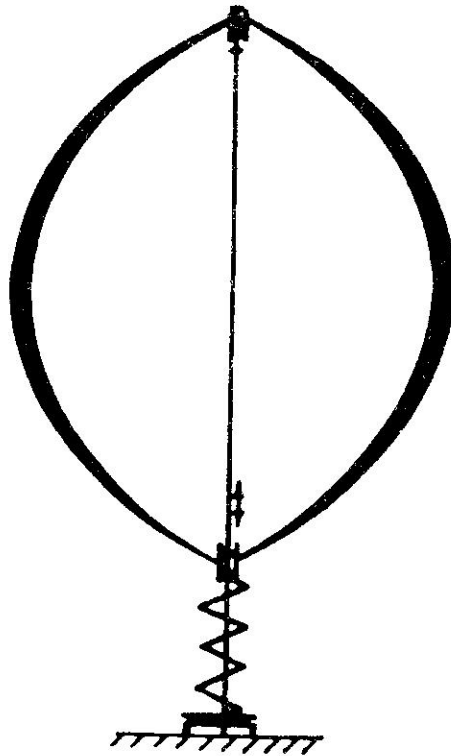

Fig. 2. New variable geometry Darrieus wind turbine with external spring.

#### THEORETICAL ANALYSIS

Several theories using a single streamtube, multiple streamtubes or vortex models have been developed to evaluate the performance of a vertical axis wind turbine (Strickland, 1975, 1976; Wilson, 1976; Blackwell, 1975, 1977; Klimas, 1978, 1980; Ayad, 1983; Paraschivoiu and Delclaux, 1983). The majority of these theories are based on momentum and blade element techniques and assume the turbine is enclosed in a single streamtube with uniform cross-sectional conditions or contained in a number of streamtubes, each with different conditions. Airfoil theory is usually used to determine the effective wind velocity on the blades. The theory generally used to more correctly predict changes in the power coefficient<sup>4</sup> produced by different wind speeds is the multiple streamtube theory. This theory is less

<sup>4</sup> The ratio of actual power output to theoretical output.

complex than the vortex theory and allows for variations in blade geometry and wind shear effects. In consequence, the multiple streamtube theory (Strickland, 1975) was selected for developing a computer simulation program to study the parameters that affect the performance of a variable geometry Darrieus wind turbine.

### Variable Geometry Model

The basic streamtube theory (Strickland, 1975) was adopted to analyze the performance of the new variable geometry Darrieus machines shown in Figs. 1 and 2. The variable geometry model uses parabolic blades (Blackwell and Reis, 1975), as an approximation for the troposkein blades (Blackwell and Reis, 1977). Using the coordinate system in Fig. 3 and the general equation for a parabola:

$$(y-k)^2 = 4p(x-h) \quad (1)$$

an expression for the radius in terms of the vertical coordinate  $Z$  was derived:

$$r = R - \frac{4H}{H^2} \left( Z - \frac{H}{2} \right)^2 \quad (2)$$

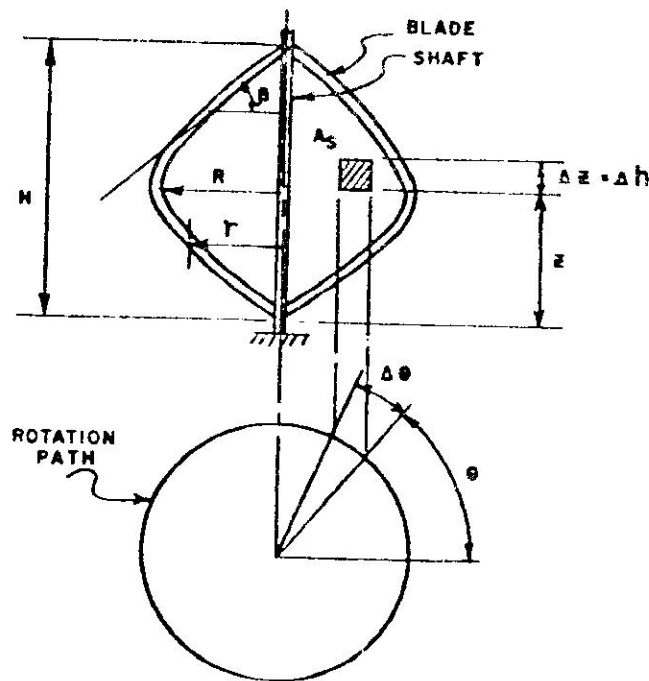

Fig. 3. Rotor geometrical parameters.

From equation (2) the blade radius for a given height can be determined. Because the angle  $\beta$  (see Fig. 3) varies with the changing geometry of the blades, this variation can be determined as well by finding the angle made by the slope of the

blade curvature at the radius  $r$  with the horizontal line.

Since  $\tan \beta = \frac{dz}{dr}$  the derivative  $\frac{dz}{dr}$  of equation (2) leads to the expression for  $\beta$ :

$$\beta = \tan^{-1} \left[ \frac{H^2}{8R} \left( (R-r) \frac{H^2}{4R} \right)^{-\frac{1}{2}} \right] \quad (3)$$

Other parameters of the parabola such as swept area, arc length, moment of inertia about the axis of rotation and radius of gyration have also been determined (Blackwell and Reis, 1975) and can be listed as follows:

1. Swept area:

$$A_p = \left( \frac{4}{3} \right) HR \quad (4)$$

2. Arc length:

$$S = \frac{H}{2} \left\{ \left( 1 + 4 \left( \frac{2R}{H} \right)^2 \right)^{\frac{1}{2}} + \frac{H}{4R} \ln \left[ \frac{4R}{H} + \left( 1 + \left( \frac{2R}{H} \right)^2 \right)^{\frac{1}{2}} \right] \right\} \quad (5)$$

3. Moment of inertia about axis of rotation:

$$I_z = \rho_b R A_p \left\{ \left( \frac{1+4B^2}{8} \right)^{\frac{1}{2}} \cdot \left( 1 - \frac{5}{16B^2} - \frac{3}{128B^4} \right) + \frac{3}{8B} \cdot \left[ \frac{1}{2} + \frac{1}{16B^2} + \frac{1}{256B^4} \right] \cdot \ln (2B + 4B^2)^{\frac{1}{2}} \right\} \quad (6)$$

where:

$$B = \frac{2R}{H}$$

4. Radius of gyration:

$$\bar{r}_p = \frac{2}{5} R \quad (7)$$

Each blade is treated as a parabolic beam which has one fixed end, is loaded uniformly, and whose deflection is being governed by centrifugal forces according to the following expression (Tuma, 1969):

$$\delta = \frac{W_H R H^3}{15 E_o I_o} \quad (8)$$

where:

$E_o$  = Young's modulus of elasticity for blade material  
 $I_o$  = cross section moment of inertia of the blade along the chord line.

The load on each segment along the blade chord line results from the centrifugal acceleration  $a_c$  acting on the blade and is defined by the expression:

$$F_c = m \cdot a_c = (\rho_b V_s) r \omega^2 \quad (9)$$

where:

$\rho_b$  = specific density of blade material

$V_s$  = volume of blade segment

The load can then be expressed in terms of  $F_c$  with the uniformly distributed mass as follows:

$$W_H = \frac{\sum^S F_c}{S} = \frac{\sum^S (\rho_b V_s) r \omega^2}{S} \quad (10)$$

where:

$S$  = arc length of parabola.

The uniformly distributed load was approximated in the computer simulation work by using the load acting at the radius of gyration:

$$W_{BH} = \frac{(\rho_b V_s) \bar{r}_p \omega^2 \bar{r}}{S} \quad (11)$$

Both the structural spring (see Fig. 1) and the external spring (see Fig. 2) experience the same deflection  $\delta$  when subject to the load  $W_{BH}$ .

$$\delta = \frac{W_{BH} N_B \tan(\pi - \beta)}{K_T} \quad (12)$$

where:

$K_T = K_{ST} + K_{SP}$  = total spring constant

$K_T = K_{SP}$  because  $K_{SP} \gg K_{ST}$

and

$K_{ST}$  = structural spring constant

$K_{SP}$  = external spring constant

#### RESULTS OF COMPUTER SIMULATION

Variable parameters such as structural and dynamic aspects of the Darrieus wind machine described above have been incorporated into the computer program to simulate the work of an actual machine in a wide range of aerodynamic conditions. To determine the dynamic aspects of the machine's behavior under simulated conditions, several assumptions were made:



- \* Blade is treated as beam of parabolic shape working within the elastic limit of its material
- \* Total load  $W_{BH}$  contributes toward the blade's deflection  $\delta$
- \* Mechanical friction at the axle due to turbine rotation and the varying geometry of the blades is negligible
- \* Load resulting from the gravitational forces is negligible.

The calculation process consists of the following steps:

1. Load on the blade is determined by using an assumed value of the angular velocity of the turbine
2. Deflection of blades is computed from equation (12) by assuming different values for  $K_{SP}$
3. New value for the turbine height is computed from:  

$$H_{new} = H_{old} - \delta$$
4. A new equatorial radius,  $R$ , which corresponds to  $H_{new}$  is computed by using Newton-Raphson method
5. New moment of inertia  $I_z$  is computed from equation (6)
6. Power coefficient,  $C_p$ , variation with tip-to-speed ratio, TSR, is determined by using the multiple streamtube theory.

Since it was expected that changes in the machine geometry would lead to changes of parameters that govern the machine's performance, such as solidity and tip-to-speed ratio TSR, these parameters and variations of  $\omega$  vs  $H$ , and  $\omega$  vs TSR were also computed.

Computations were done for the Darrieus wind machine that has the following characteristics (Worstell, 1981): turbine height = 17 m (55.8 ft), turbine diameter = 16.7 m (54.9 ft), swept area = 187 m<sup>2</sup> (2014 ft<sup>2</sup>), arc length = 24.1 m (79 ft), blade mass = 323 kg (713 lbm), chord length = 0.533 m (1.75 ft), number of blades = 2 or 3, aerofoil section = NASA 0012. The computer simulation program was run for the values of  $E_0 = 10^6$  psi  $I_0 = 20.645 \text{ in}^{-4}$ ,  $R_e = 0.3 \times 10^6$ ,  $C_N$  and  $C_T$  taken for the values of the angle of attack  $\alpha$  which was calculated according to the multiple streamtube theory.

The computer program was checked out by computing the variation of the coefficient of performance,  $C_p$ , versus tip-to-speed ratio, TSR, for the Darrieus wind machine having the parameters above. It was found that the results agreed well with those obtained elsewhere (Worstell, 1981).

The results for the concept shown in Fig. 1 so far indicate that the structural spring constant of the blades is too small and allows the blades to deflect greatly when they are subjected to aerodynamic forces under real life operation parameters; for  $\omega = 60.96 \text{ m/s}$  (200 ft/s) the blade deflection was 11.07 m (36.33 ft). Such deflection is unacceptable structurally. During the change in the machine's geometry the solidity value decreased from about 0.13 to below 0.10 which led to a slight decrease in the peak value of the machine's power coefficient.

Within the rotational velocity values used (up to 69.57 rev/min), the change in turbine geometry, although large, was not sufficient to make the turbine regulate its speed by acting like a governor.

To control the Darrieus turbine geometry within acceptable blade structural limits and to dampen possible oscillations, an external spring was added as shown in Fig. 2. The computer simulation was done for different external spring constants ranging from  $K = 3000$  to  $K = 30000$ . As shown in Fig. 4 the turbine

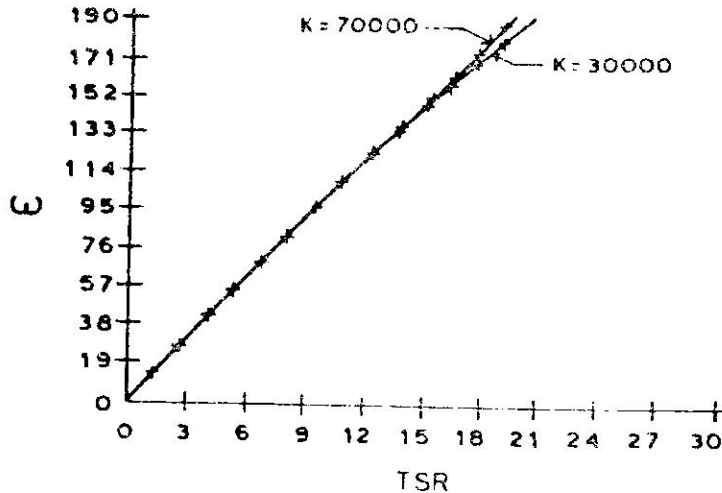

Fig. 4. Variation of Darrieus turbine angular velocity  $\omega$  (ft/s) with tip-to-speed ratio, TSR, for spring constant  $K = 30000$  and  $K = 70000$ ;  $N_B = 2$ ,  $C = 0.533$  m (1.75 in).

geometry is almost fixed for  $K = 30000$  and varies very little for higher values of  $K$ . The results indicate that by selecting a proper spring constant (see Figs. 5 and 6) the blade deflection can be reduced to reasonable limits. The solidity variation is almost the same as for the former concept with a structural spring constant. Although the turbine responds to the variation in rev/min like a governor, as shown in Fig. 7, when replacing  $K = 30000$  by  $K = 3000$  in the computer simulation program, the machine operation parameters are even farther away from reaching governor conditions because the change in geometry is smaller than for the concept shown in Fig. 1 for the limits of  $\omega$  used in computations. As can be seen, the curve on the figure changes its shape for different  $K$  values and ultimately may bend and reach a plateau at higher values of  $\omega$  and TSR when governor operation conditions are reached.

This first generation variable geometry Darrieus wind machine led to a second generation turbine which is now being investigated. The concept allows the turbine to increase its radius by almost two-thirds of its initial value by using telescopic blades. It is expected that the machine will respond more like a governor. The use of a variable spring constant may be warranted to control the turbine geometry within a broader range of operation parameters. The solidity will vary from 0.13 to about 0.08 which for  $R = R_{max}$  will result in a stronger  $C_p$  variation.

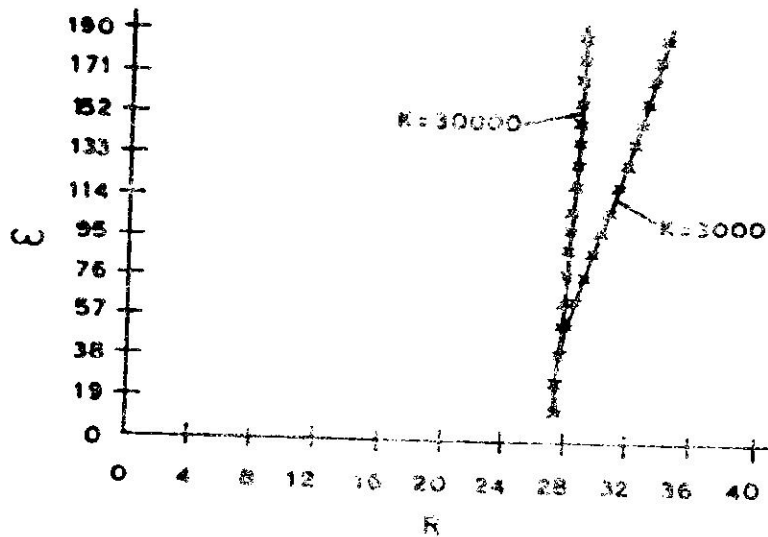

Fig. 5. Variation of Darricus turbine radius  $R$ (ft) with angular velocity  $\omega$  (ft/s) for  $K = 3000$  and  $K = 30000$ ;  $N_B = 2$ ,  $C = 0.533$  m (1.75 in).

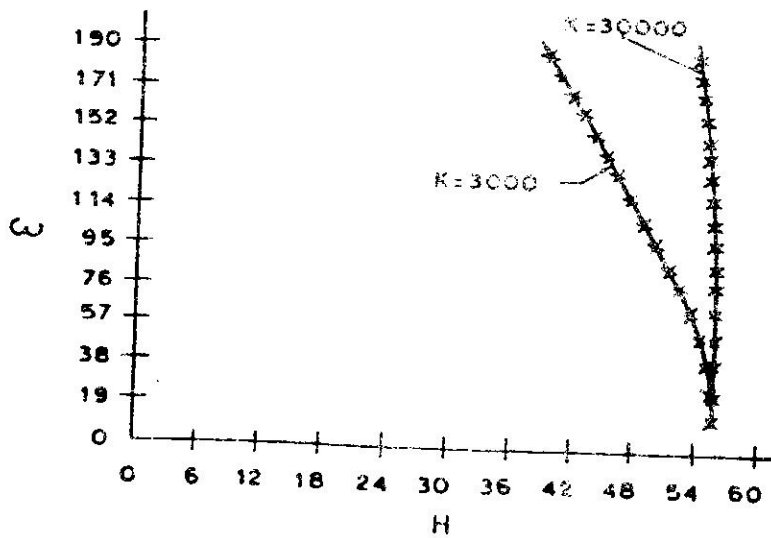

Fig. 6. Variation of Darricus turbine height,  $H$ (ft), with angular velocity  $\omega$  (ft/s) for  $K = 3000$  and  $K = 30000$ ;  $N_B = 2$ ,  $C = 0.533$  m (1.75 in).

More spreadout optimum values are expected for  $C_p$  vs TSR as shown in Fig. 8 (Strickland, 1975).

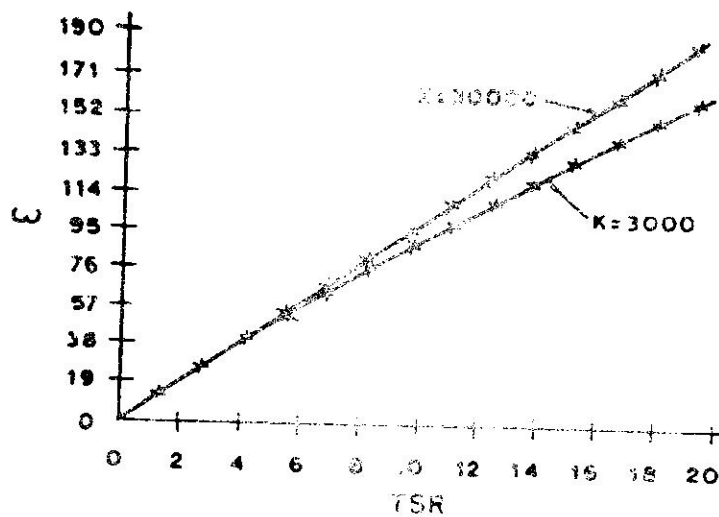

Fig. 7. Variation of Darrieus turbine angular velocity  $\omega$  (ft/s) with tip-to-speed ratio, TSR, for spring constant  $K = 3000$  and  $K = 30000$ ;  $N_B = 2$ ,  $C = 0.533$  m (1.75 in).

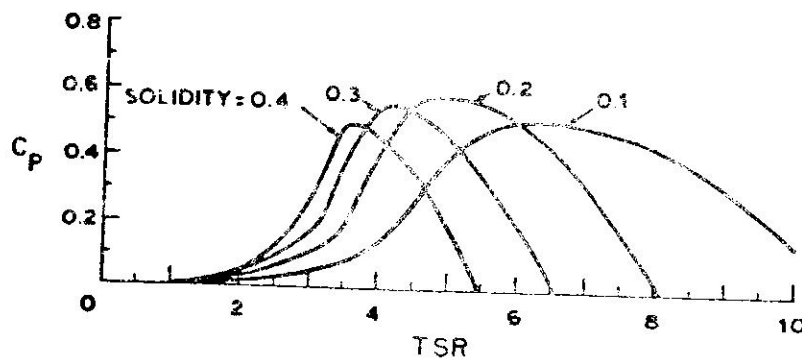

Fig. 8. Variation of coefficient of performance,  $C_p$ , with tip-to-speed ratio, TSR, for different solidity values.

### CONCLUSIONS

The variation of turbine geometry during normal operation does not change the turbine moment of inertia enough to make it act as a governor. Therefore the turbine can not self-regulate its rotational velocity. The decrease of the solidity due to the increase of the turbine radius causes a slight decrease in the peak value of the coefficient of performance and some flattening of the curve  $C_p$  vs TSR. This creates a possibility for spreading out the optimum  $C_p$  throughout a range of TSR values. The variable centrifugal force can cause oscillations in structural and external springs. This effect should be investigated together with other structural aspects of the blades. As the result of this study a new generation of variable geometry

Darrieus wind machine with telescopic blades is proposed as an alternative to the fixed geometry machine.

#### ACKNOWLEDGEMENTS

The authors express their appreciation to Dr. Juan A. Bonnet, Jr., Director of the Center for Energy and Environment Research, for his support and interest in this research. Thanks are also due to the University of Puerto Rico for providing a student fellowship grant to one of the authors (D.S.).

#### REFERENCES

- Ayad, S. S. (1983). Numerical Study of the Performance of Tornado-Type Wind Energy Systems, J. Energy (AIAA), 7, 134-140.
- Blackwell, B. F. and G. E. Reis, (1975). Some Geometrical Aspects of Troposkeins as Applied to Vertical-Axis Wind Turbines, SAND74-0177, Sandia Laboratories, Albuquerque, New Mexico, U.S.A.
- Blackwell, B. F. and G. E. Reis, (1977). Blade Shape for a Troposkein Type of Vertical-Axis Wind Turbine, SLA-74-0154, Sandia Laboratories, Albuquerque, New Mexico, U.S.A.
- Klimas, P.C. and R. E. Sheldahl (1978). Four Aerodynamic Prediction Schemes for Vertical-Axis Wind Turbines: A Compendium, SAND78-0014, Sandia Laboratories, Albuquerque, New Mexico, U.S.A.
- Klimas, P.C. (1980). Vertical Axis Wind Turbine Aerodynamic Performance Prediction Methods, Proceedings of the Vertical Axis Wind Turbine (VAWT) Design Technology, SAND80-0984, 215-232, Albuquerque, New Mexico, U.S.A.
- Paraschivoiu, I. and F. Delclaux, (1983). Double Multiple Streamtube Model with Recent Improvements, J. Energy (AIAA), 7, 250-255.
- Strickland, J. H., (1975). The Darrieus Turbine: A Performance Prediction Model Using Multiple Streamtubes, SAND75-0431, Sandia Laboratories, Albuquerque, New Mexico, U.S.A.
- Strickland, J. H., (1976). Aerodynamics of the Darrieus Turbine, Proceedings of the Vertical-Axis Wind Turbine Technology Workshop, SAND76-5586, Sandia Laboratories, Albuquerque, New Mexico, U.S.A.
- Tuma, J. J., (1969). Structural Analysis, McGraw Hill, New York.
- Wilson, R. E., (1976). Aerodynamics of the Darrieus Rotor, Proceedings of the Vertical-Axis Wind Turbine Technology Workshop, SAND76-5586, Sandia Laboratories, Albuquerque, New Mexico, U.S.A.
- Worstell, M. H., (1981). Aerodynamic Performance of the DOE/Sandia 17-m Darrieus Vertical-Axis Wind Turbine, J. Energy (AIAA), 5, 39-42.

