

Willy Widgeon

Runways are for Airplanes

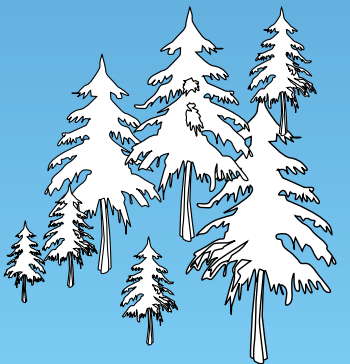

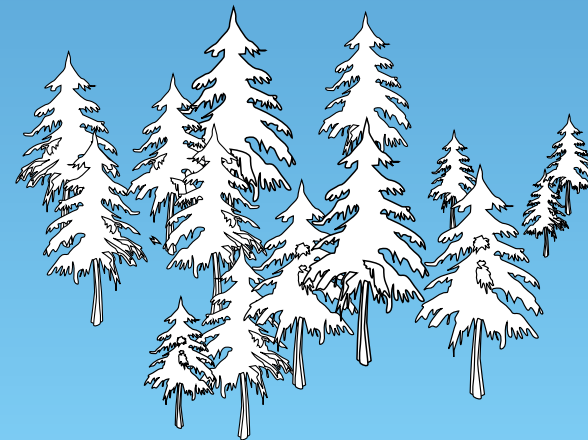
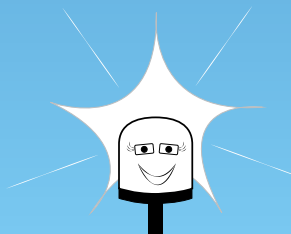
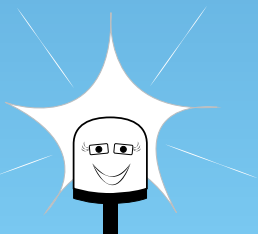
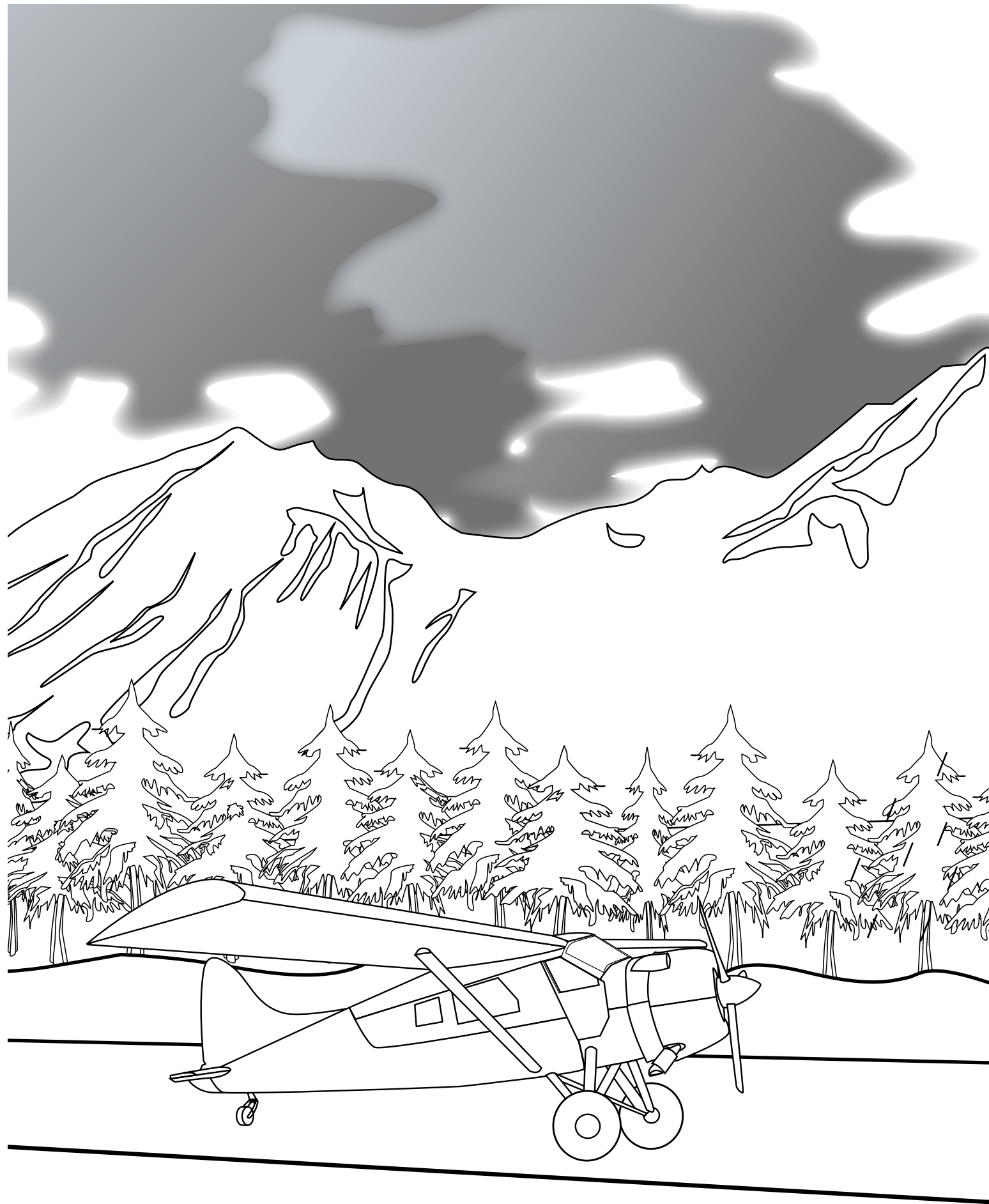

DANGER

KEEP OFF RUNWAY



Produced by
Alaska Department of Transportation & Public Facilities, Statewide Aviation
and
Federal Aviation Administration

Illustrations by Vanessa Rathbun, B.L.M.
Additional illustrations by Andrea Deppner, Alaska DOT&PF

2018

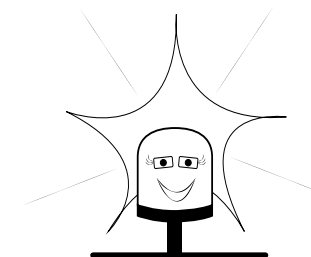

Connect the dots to help Willy Widgeon's plane safely land!

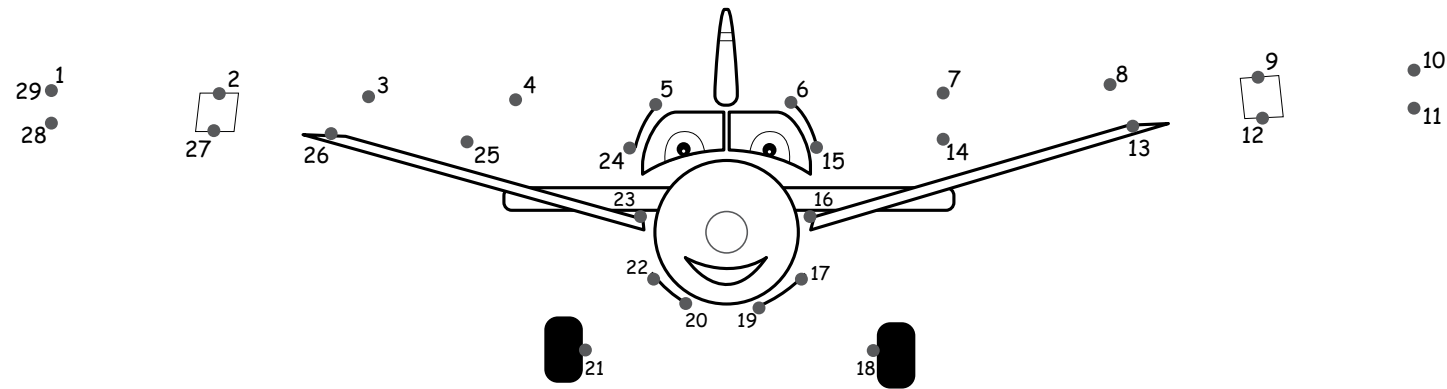

Did you find all the words about runway safety?

Answer key for word search on page 7.



Answers to page 3.

D. All of these

When is it okay to be on the runway?
Only when you are already inside the airplane and safely buckled into your seat.

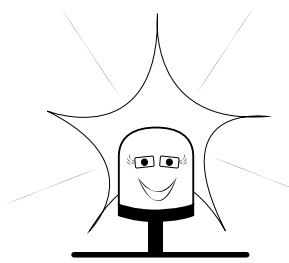
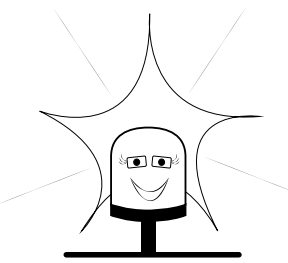

Willy Widgeon is a Bush pilot. He flies all around Alaska. He knows that runways are for airplanes. If runways are safe, he can make safe landings.

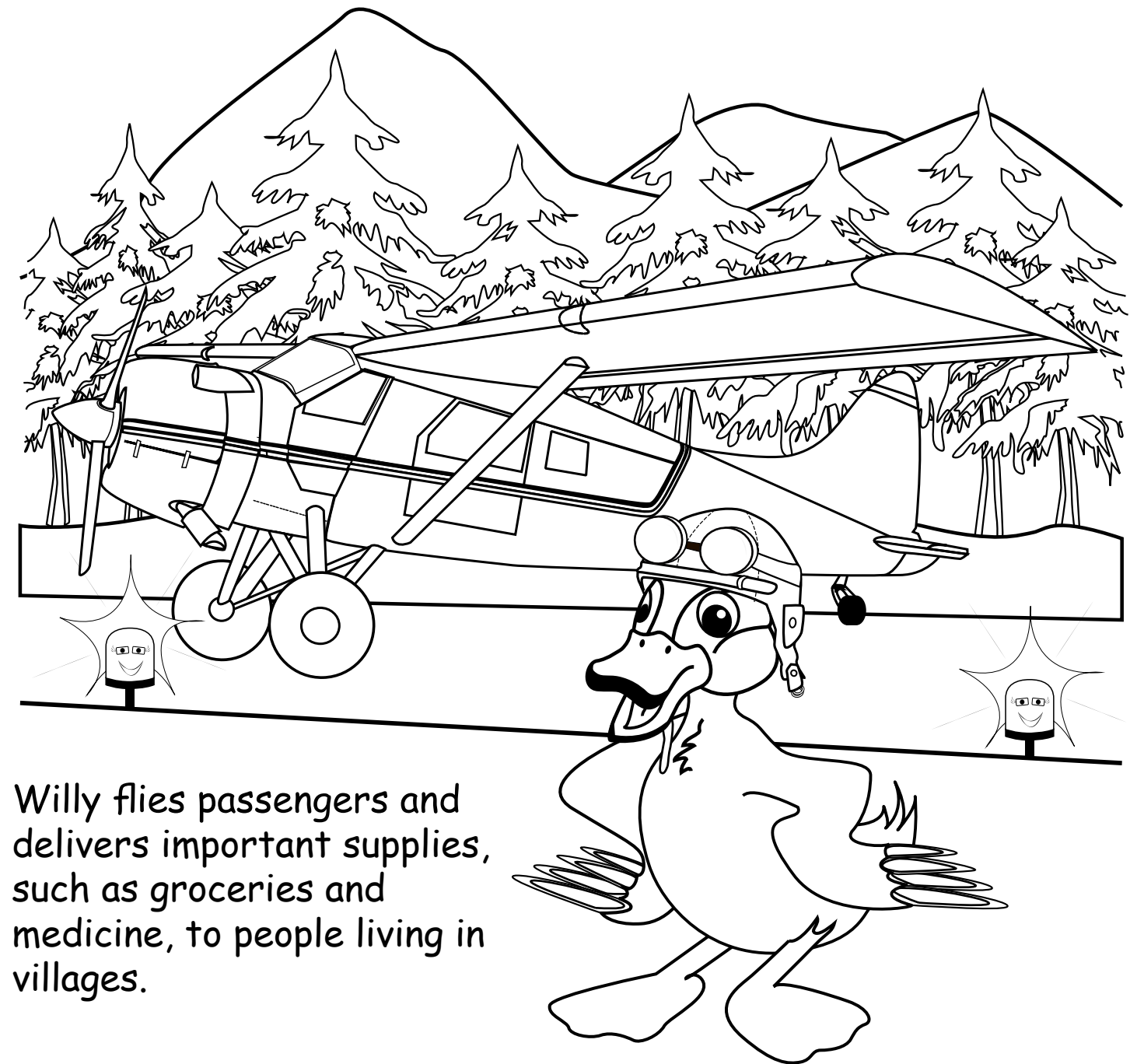

Willy flies passengers and delivers important supplies, such as groceries and medicine, to people living in villages.

What are some things you and your family have received from a plane?

On the last flight of the day, Willy Widgeon is flying Otto Otter home to The Village along with supplies for Otto's neighbors.

As they approach The Village's airport for landing, Willy doesn't like what he sees.

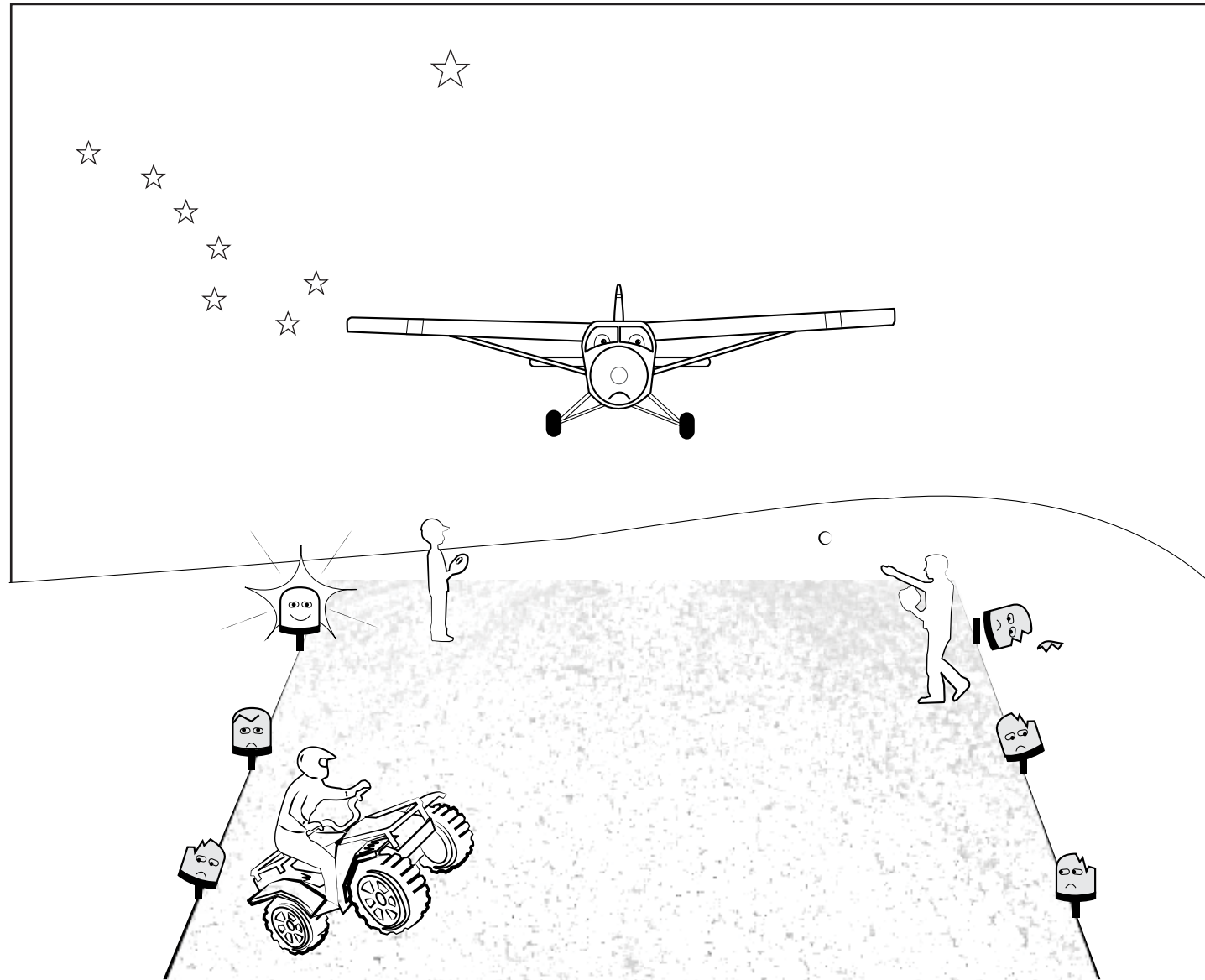

"Oh no," Willy says, "I see kids playing on the runway, the runway lights look broken, and it's not safe to land. I'm sorry, Otto, but your neighbors will have to wait longer for their supplies."

Can you find the only runway light that is not broken?

Help Pilot Willy and Lisa Light find words about airplanes and runway safety!

Q O D H T N P O X S P V M D B Z E S O R
M Q Q O N E S T Z Z T M I W P L M H M U
Y O J E X I W O X S P I G L V C S A U A
O L P Y Q G V O N N E K X U L X Q U P L
E A U I Q H F U L L M F S Y N A W V X X
W N T P T B M Y T T F F J U G Y G M F E
R D A G X O T V B X S N H J P B B E B J
I I L P X R Z F A J G H L X N P D P R N
P N G G E S J M I O P J M C P J L Q O R
N G S J L M L I R N P Z B L K I N I K L
B S L L J G B J P E N C Y E O T U K E F
K A O I Q V K B L L N J I A H Q V V N S
M F O Q G S V L A D P T S R F M M E W J
O E T M Y H U Z N E L K C U A T E P X V
S T O L G R T E E I A R W N M J D B C I
V Y D Y Y P I S C I Y A H W I G I A K W
T S I D G A P K W F S H J A L N C O J N
V U N V Q W R N L H D J U Y Y S I X Z B
I D C J S Z L U Z I L M K W X Q N K V H
I T E D I O H R B H J G O M X G E E N N

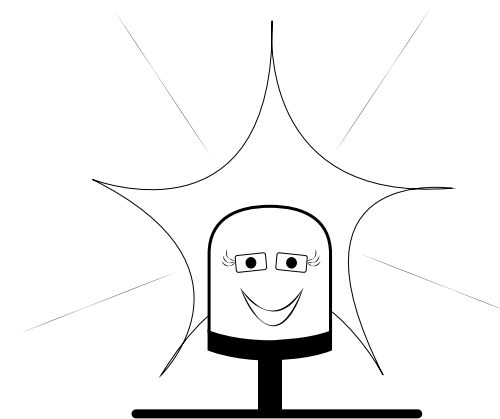

lights
runway
airplane
landing
safety
neighbors
broken

supplies
medicine
broken
village
family
play
clear

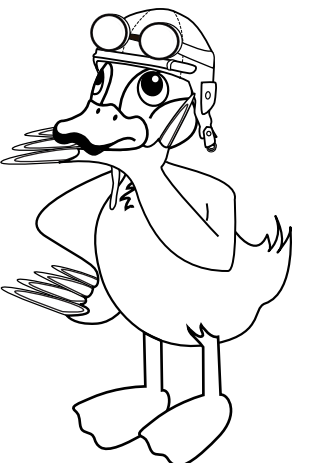

"Nice landing Pilot Willy!" shouts Otto as they touch down. Willy and Otto exit the plane, and see Beth waiting for them. "Nice to see you! I'm sorry you had trouble landing yesterday. We need to remind our people how important a safe runway is, and that runways are for airplanes!"

Otto smiles, knowing that he and The Village's important supplies have arrived safely home.



As the plane turns away from the runway, Otto is unhappy they cannot land.

"That's not good," complains Otto. "It's really important I get home, and The Village really needs these supplies! I thought everyone knew that runways are only for airplanes!"

Willy nods and says, "It's getting really dark, but we will give it another try tomorrow."

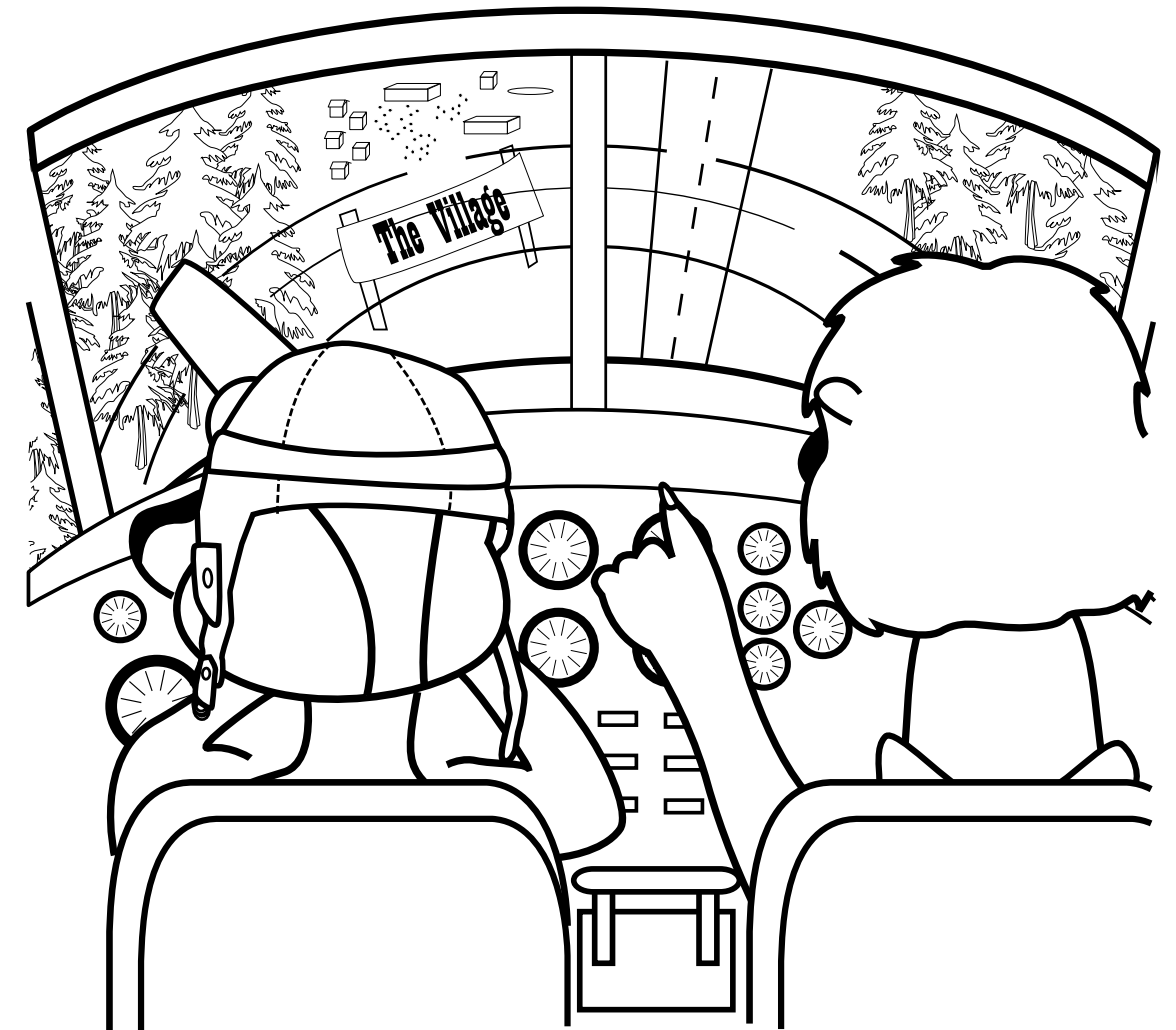

What are things you should not do on a runway?

- A. Ride a four-wheeler or bike
- B. Play ball
- C. Play tag
- D. All of these

When is it okay to be on a runway?

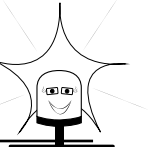

Back at the office, Willy calls Beth Bear, who is in charge of The Village's runway. Beth tells Willy she's been having problems with runway lights getting broken and kids playing on the runway.

"The lights cost a lot of money, but people keep breaking them," Beth complains.



"Well, it's a bummer when the planes can't land," says Willy. Beth agrees and tells Willy the runway will be cleared and the lights will be replaced by tomorrow afternoon.

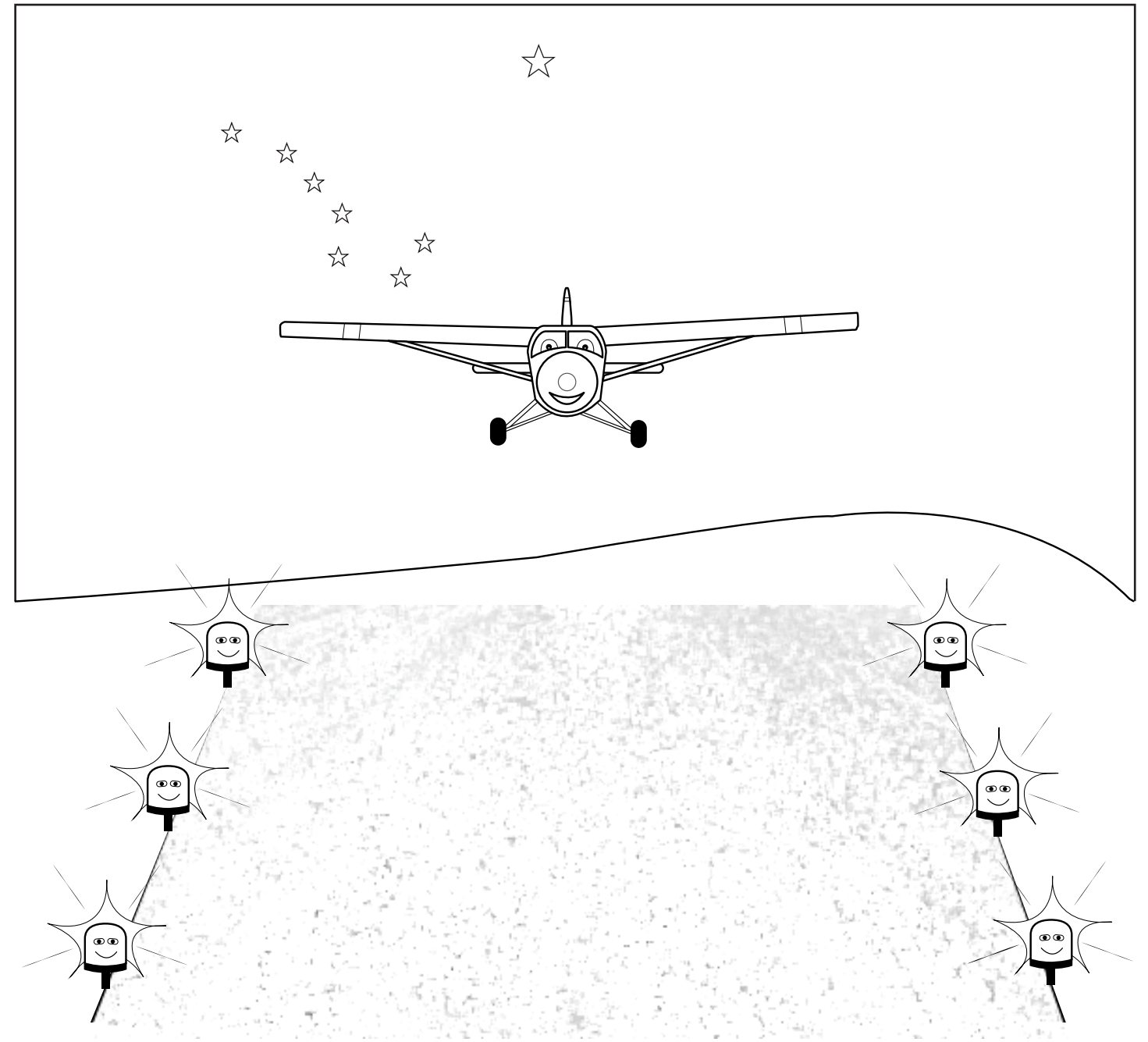

The next afternoon, as the sky begins to darken, Willy and Otto make their approach to The Village's runway.

Guess what they see?

"The runway is clear and well-lit!" declares Willy. "We are good to safely land!"