

# COMSOL NEWS

THE MULTIPHYSICS  
SIMULATION MAGAZINE



## Powering Vehicles with Hydrogen

Simulation-driven  
generative design  
speeds up fuel cell  
R&D at Toyota

PAGE 10





In developing countries,  
simulation puts harvest shelf-  
life data into the hands of  
farmers and traders

PAGE 6

## Seeing the Bigger Picture with Simulation

Whether it is a mountain landscape or an up-close view of a jaguar's face, the pieces of a puzzle seamlessly connect to reveal a bigger picture. Like puzzle pieces, every component in a design or process must function properly on their own and work well together. Every day, engineers, scientists, and researchers around the world use multiphysics modeling and simulation to understand and optimize the individual pieces that make up the complete system. We have compiled several of their inspiring stories in this year's edition of *COMSOL News*.

On page 10, you will meet a team from the Toyota Research Institute of North America that came up with a simulation-driven methodology for optimizing flow field microchannel plates, ultimately furthering the development of hydrogen-powered vehicles. You will also find a story about how Zeugin Bauberatungen is analyzing how sound-absorbing curtains and foam panels help reduce noise distractions in open-plan office designs.

In addition, there are articles on the creation and deployment of simulation apps for analyzing specific aspects of large-scale processes. One example shows how simulation apps are used for predicting the shelf life of fresh produce, thereby improving the use of refrigerated food storage in developing countries. Another story features an app that helps construction teams make informed decisions throughout each project to avoid overspending while delivering the best results possible.

This year, we are also sharing a few articles with tips and inspiration on topics like visualization, 3D motor modeling, and MEMS devices. No matter the field or the application, great designs come together when each piece is optimized with the bigger picture in mind.

Rachel Keatley  
COMSOL, Inc.

---

### INTERACT WITH THE COMSOL COMMUNITY

**BLOG** [comsol.com/blogs](https://comsol.com/blogs)

**FORUM** [comsol.com/forum](https://comsol.com/forum)

**LinkedIn™** [linkedin.com/company/comsol-inc-](https://linkedin.com/company/comsol-inc-)

**Facebook®** [facebook.com/multiphysics](https://facebook.com/multiphysics)

**X (formerly known as Twitter®)** [twitter.com/COMSOL\\_Inc](https://twitter.com/COMSOL_Inc)

---

We welcome your comments on *COMSOL News*. Contact us at [info@comsol.com](mailto:info@comsol.com). To view these stories and their related resources (including references and models) online, visit [comsol.com/stories](https://comsol.com/stories).

© 2023 COMSOL. COMSOL, COMSOL Multiphysics, COMSOL Server, and COMSOL Compiler are either registered trademarks or trademarks of COMSOL AB. All other trademarks are the property of their respective owners, and COMSOL AB and its subsidiaries and products are not affiliated with, endorsed by, sponsored by, or supported by those trademark owners. For a list of such trademark owners, see [www.comsol.com/trademarks](https://www.comsol.com/trademarks).

LinkedIn is a trademark of LinkedIn Corporation and its affiliates in the United States and/or other countries. Facebook is a registered trademark of Facebook, Inc. TWITTER is a registered trademark of X Corp.

# TABLE OF CONTENTS



## MODELING IN PRACTICE

- 4** **Tips for Model Visualization**  
COMSOL, Massachusetts, USA



## DEMOCRATIZING SIMULATION

- 6** **Forecasting Fruit Freshness with Simulation Apps**  
*Empa, Switzerland*
- 16** **Bringing Multiphysics Simulation to Construction Sites**  
*Heidelberg Materials, Norway and Sweden*

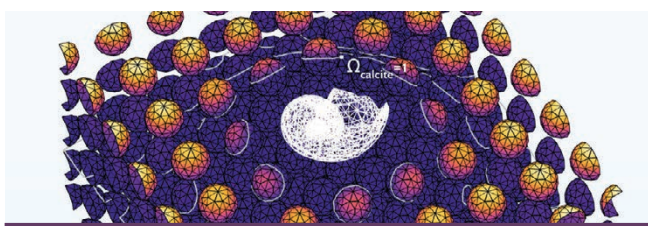

## RESEARCH SPOTLIGHT

- 10** **Generative Design Puts Hydrogen Fuel Cell Development in High Gear**  
*Toyota Research Institute of North America, Michigan, USA*
- 26** **How Decaying Shells Help Preserve the Alkalinity of the Seas**  
*Utrecht University, Netherlands*

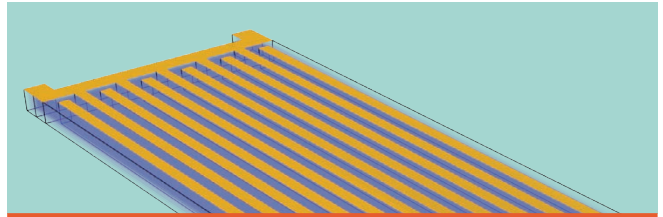

## MULTIPHYSICS INNOVATION

- 14** **RF MEMS Resonators, the Building Blocks of Communication Systems**  
COMSOL, Massachusetts, USA

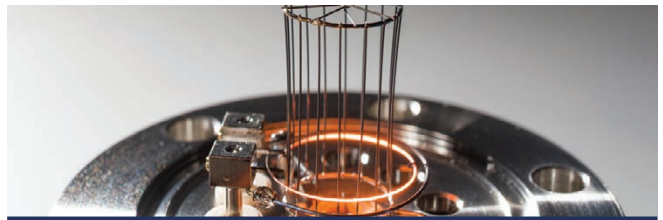

## SIMULATION-BASED PRODUCT DEVELOPMENT

- 20** **Elevating the Performance of Ionization Gauges with Simulation**  
*INFICON, Liechtenstein*
- 33** **Shifting to 3D: Motor Modeling Gears Up for Vehicle Electrification**  
COMSOL, Sweden

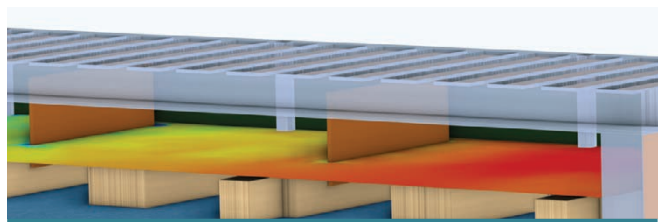

## DESIGN OPTIMIZATION

- 23** **Thermal Modeling of Small Satellites**  
COMSOL, Massachusetts, USA
- 30** **Harmonizing Sound and Style in Open-Plan Offices**  
*Zeugin Bauberatungen, Switzerland*



# Tips for Model Visualization

by DIXITA PATEL

Models represent real-world counterparts. This could be interpreted as strictly making sure the dimensions, overall shape, and physics are accurate. Or, you could take it one step further and make your model look as realistic as possible through thoughtful color, texture, and lighting choices. The techniques shown here will help you generate useful results and amp up the visual appeal of your models.

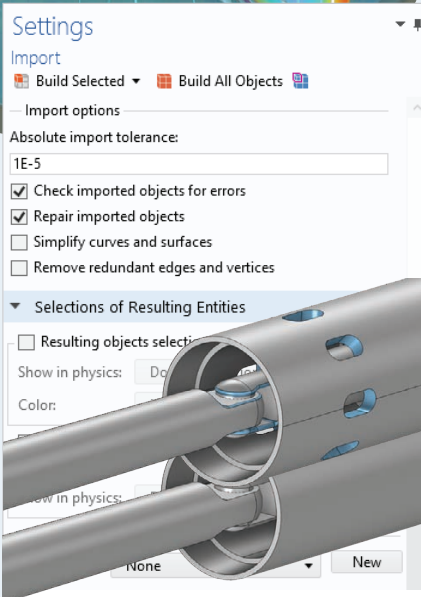

## GEOMETRY

Get the shape and dimensions right from the start. Build the geometry from the ground up or import 3D CAD files using an interfacing product.

Make the model easier to interpret by assigning colored selections to domains and boundaries. Find tools for repairing defective geometry, defeaturing overly detailed geometry, and removing geometric entities to make the model ready for analysis.

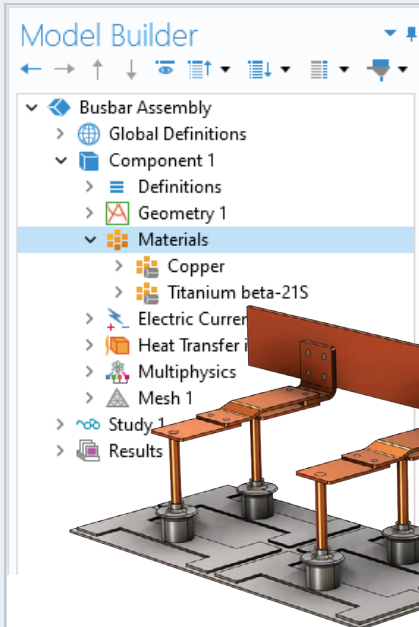

## MATERIALS

Match the colors and texture to reality. When assigning materials to the geometry, it is possible to render the model components in the actual color of the material. Select the *Show Material Color and Texture* option to help visualize material-true rendering of the assigned materials.

To create realistic visualizations, it is also possible to mix plots showing simulation results and parts of the geometry using the *Material Appearance* feature.

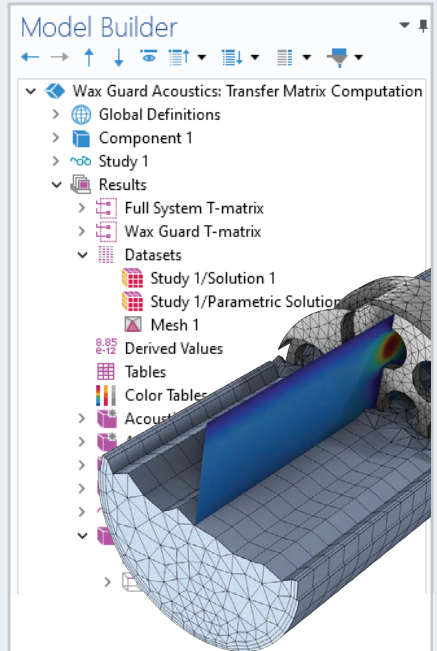

## MESH

Create the appropriate mesh automatically or manually. All of the plots under the *Results* node refer to a dataset that contain solutions for visualization and results analysis. You can use the *Mesh* dataset type with a *Mesh* plot to visualize mesh-related quantities without computing a solution.

This is useful for displaying the mesh quality in 2D or 3D, the mesh size, or to show different mesh element types, such as triangles, tetrahedrons, and pyramids.



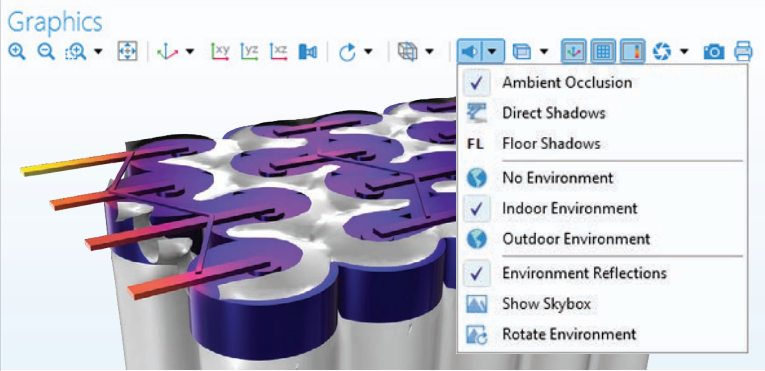

## SCENE LIGHTING

Turn up the realism. The *Ambient Occlusion*, *Direct Shadows*, and *Floor Shadows* features add realistic lighting, and you can improve depth perception with interobject shadows. The *Indoor Environment* and *Outdoor Environment* options add reflections.

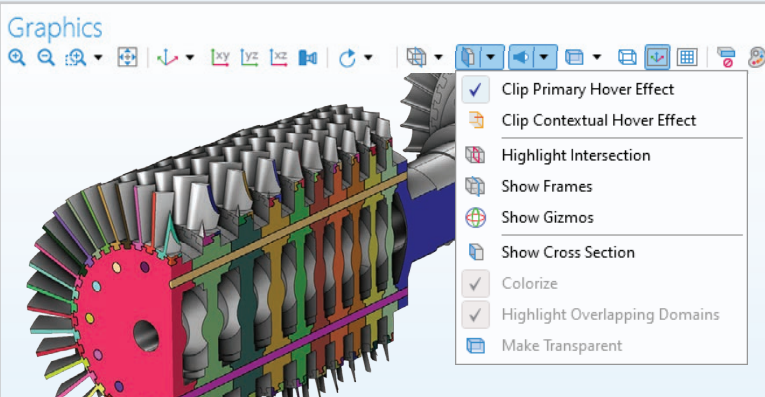

## CLIP PLANES

See inside complex geometries. The interactive clipping functionality helps you select edges, boundaries, and domains located within intricate 3D geometries. Add clip planes, boxes, cylinders, and spheres to select which parts to show.

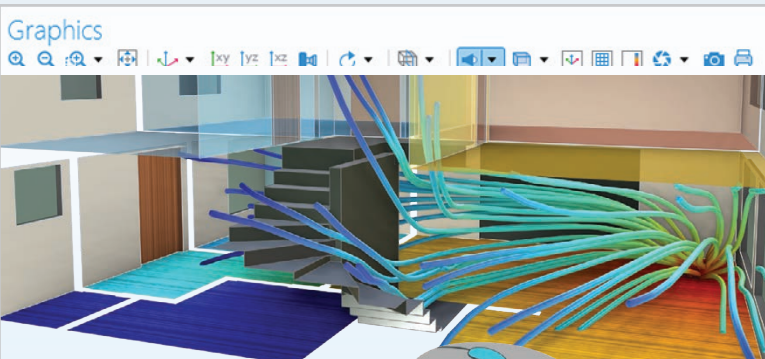

## MOUSE DOLLY

Change the perspective. Use this shortcut to move the camera through objects in a scene and create eye-catching visuals of the geometry.

## FOLLOW ALONG

Ready to put the tips into practice? Open these example models in COMSOL Multiphysics® to get started! By combining multiple features in the software, you can enhance your simulation results with stunning visuals.

Application ID: 10368

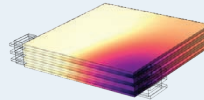

Default temperature plot.

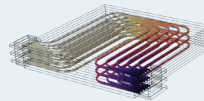

Select flow channel boundaries and add material appearance.

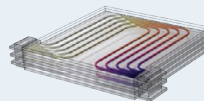

Select the battery pack boundaries and add material appearance and transparency.

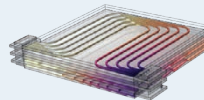

Add isothermal contours expressing the temperature.

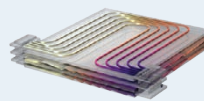

Deselect *Plot Dataset Edges* and turn on *Ambient Occlusion* lighting.

Application ID: 18837



Default *Radiation Pattern* plot depicting the far-field gain.



Add transparency and white, fine grid lines.

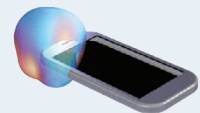

Select the outer cellphone boundaries and add material appearance and color.

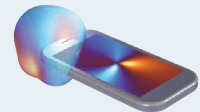

Select the screen boundary and add a surface plot expressing the far-field gain.

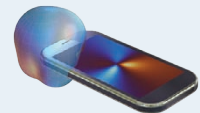

Turn on *Indoor Environment* lighting.



Empa, Switzerland

# FORECASTING FRUIT FRESHNESS WITH SIMULATION APPS

Swiss research organization Empa built models and compiled a simulation application that feeds results into a smartphone app used by farmers and traders to predict the shelf life of fresh fruits and vegetables. The work is in support of a multinational coalition whose goal is to improve the use of refrigerated food storage in developing countries.

by RACHEL KEATLEY

The post-harvest journey of fresh produce is a notably weak link in the global food supply chain. Each year, approximately one-third of the food produced for human consumption worldwide is lost or wasted. Refrigerated

distribution and storage problems play a major role in these losses, especially in developing countries like India, where a mere 6% of food production enters the refrigerated "cold chain" — leaving it vulnerable to decay. Currently, the scarce

refrigerated space, such as small, solar-powered cold storage rooms (Figure 1), may be occupied by crops that are already past their peak, even as other shipments decay while waiting for access to a cold room.

As part of a multinational consortium of food supply chain stakeholders, the Swiss Federal Laboratories for Materials Science and Technology (Empa) and the Basel Agency for Sustainable Energy (BASE) developed Coldtivate to help alleviate these problems. Coldtivate is a mobile app that informs its users of the cooling and decay process of different types of fruit in real time. It was rolled out to cold storage operators in three regions of India in late 2022 and in Nigeria in 2023, and it is powered by multiphysics simulation. The farmers who use the app do not actually see the underlying multiphysics models or interact directly with the simulation app: they get the results delivered in a way that is actionable to them through the Coldtivate mobile app.



**FIGURE 1** Cold rooms used for storing crops after harvest.



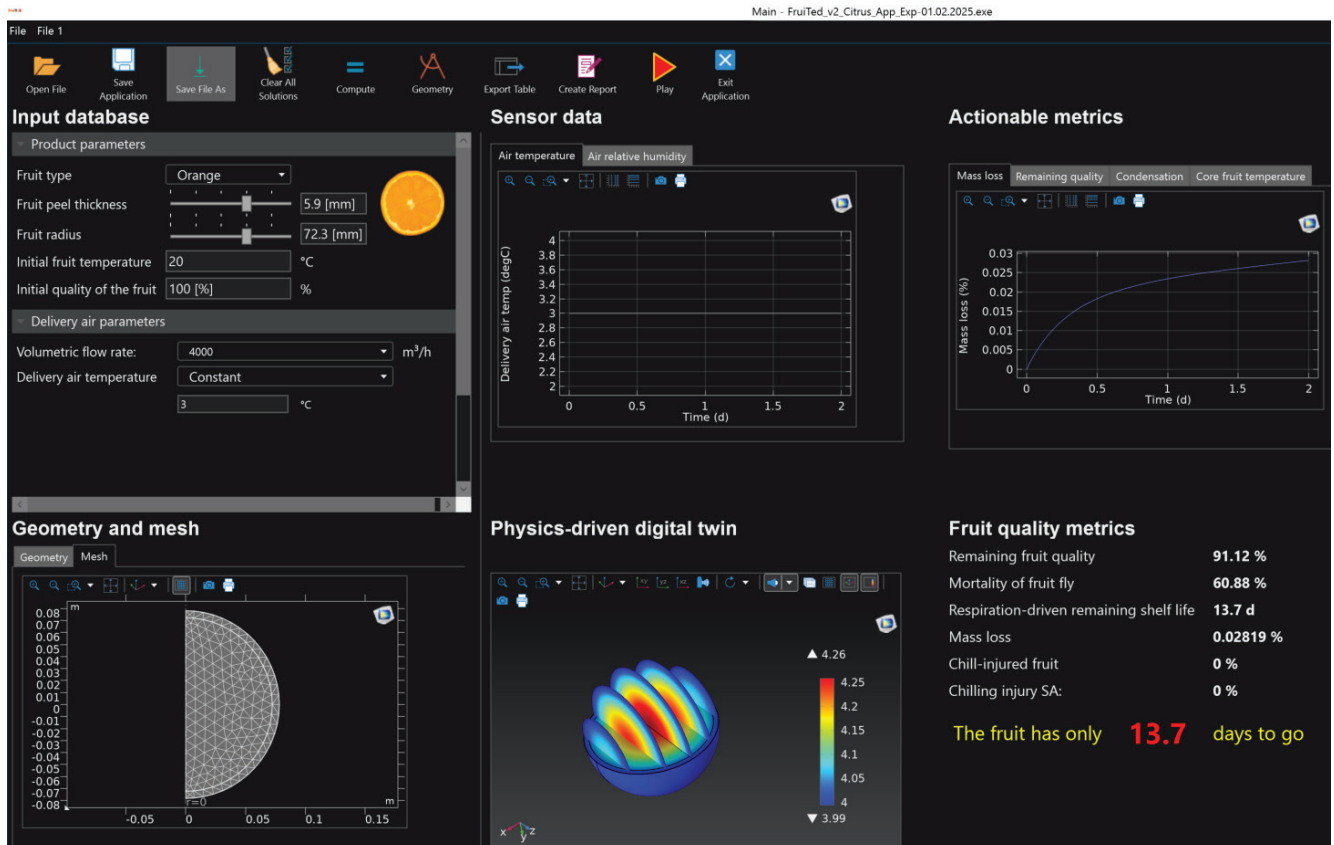

**FIGURE 2** Empa's COMSOL app running on a desktop computer, which generates many indicators related to produce freshness.

## » SIMULATION-BASED PREDICTIONS TO OPTIMIZE FOOD STORAGE

The Coldtivate mobile app provides data-driven forecasts on the freshness of produce in a cold room. These forecasts are relayed from a simulation app (Figure 2), which Empa built with the COMSOL Multiphysics® software and its built-in Application Builder.

Simulation apps are easy-to-use interfaces that are made from existing COMSOL Multiphysics models, where the app designer decides which inputs and outputs to display. Simulation apps are ready-to-use as is, but Empa and BASE wanted to relay their simulation app's data in a way that would be most familiar to their end users, primarily farmers. Since mobile apps are widely used in modern agricultural practices, they developed Coldtivate to act as the user interface for their end users.

"Our COMSOL app runs on the same headless server that hosts the mobile

app," explained Joaquin Gajardo, data scientist at Empa and technical colead for the Coldtivate project. This is what enables both the simulation app and mobile app to relay information back and forth between one another. "We've used the Application Builder to automate the updating of simulations based on changing input parameters [in the mobile app]," said Gajardo. This combines the capabilities of Empa's multiphysics model with the convenience of a purpose-built mobile app. For their simulation app to be used in such a way, they first compiled it into a standalone executable using COMSOL Compiler™.

"Without the Application Builder, it would have been impossible to roll out the digital twins into a mobile app and democratize these multiphysics simulations, and their results, to a broader audience of beneficiaries, like smallholder farmers," said Thijs Defraeye, senior scientist at Empa and professor at Wageningen University & Research.

## » THE MODEL BEHIND THE SIMULATION APP

Ambient temperatures directly influence the shelf life of fresh produce. But while thermometers are found inside most refrigerated storage units, the data they provide is insufficient for predicting how long fruits and vegetables will last.

"We cannot establish the expected lifespan of produce with a single temperature or humidity curve from a cold room," said Defraeye. "The COMSOL model of each crate receives actual temperature and humidity data from the cold storage rooms, enabling frequent recalculation of remaining shelf life." This model is what Empa's simulation app is based on.

In addition, a sensor in one section of the storage space does not necessarily reflect the temperature on the surface of an apple buried inside a crate, especially if that crate was only recently brought indoors.



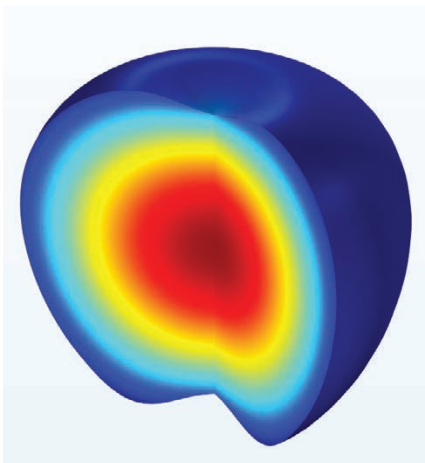
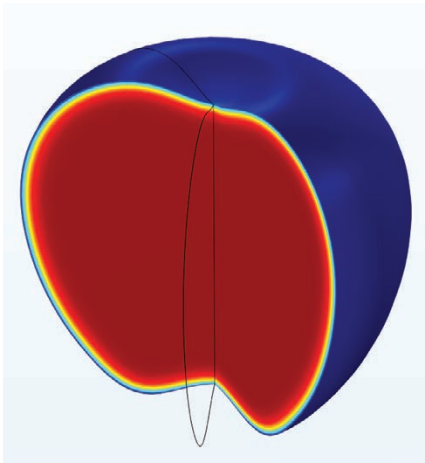

**FIGURE 3** Results of Empa's COMSOL model of an apple, showing how surface temperatures will affect internal temperature distribution over time.

To provide a fuller picture of how each shipment of produce may be affected by varying storage conditions, Empa is currently expanding the models to model entire shipments of various fruits and vegetables using COMSOL Multiphysics (Figure 3). "For this, we need to use a porous media modeling approach to generate actionable metrics from sensor readings," said Defraeye.

**» THE APP IN ACTION**

"Let's say a new shipment arrives at a cold room," Gajardo proposed. "The operator opens the Coldtivate app on their phone and enters the type of produce, current temperature, days since harvest, and other relevant values. The mobile app then generates a text file

containing this information. The values in this text file serve as input arguments for the COMSOL app, which then calculates the expected shelf life. This calculation is then written into an output file, and the remaining quality and number of days are subsequently displayed in the mobile app's user interface."

Every six hours, the values shown on the Coldtivate app are recalculated with updated forecasts based on the latest cold room temperature data (Figure 4). Farmers can directly check the remaining shelf life of their crates in the mobile app. If they do not have a smartphone, "warehouse operators can notify them of how long their produce will remain fresh in the cold room," said Gajardo. Ultimately, this information will help farmers avoid distress selling and unnecessary disposal of unsold produce.

**» TEAM EFFORT LEADS TO TRUSTWORTHY DATA**

Defraeye and his team at Empa have devoted years to building their data-gathering and modeling process. "In early 2021, we were already making models [for analyzing produce freshness], but they were not yet rolled out in actual supply chains," Defraeye said. Inquiries from nonprofit global development organizations sparked the effort that led to the creation of the Coldtivate mobile app (Figure 5).

"We were contacted by BASE, which develops innovative business models to help farmers make better use of available resources," Defraeye said. "The idea was to combine a pay-per-use business model with intelligence that could improve access to cooling. To do that, we needed other partners with close links to the people we wanted to help." These partners included cooling companies and other stakeholders in the Indian states of Bihar, Himachal Pradesh, and Odisha, who joined BASE and Empa in an initiative called Your Virtual Cold Chain Assistant (Your VCCA).

"Trust is the key ingredient," said Defraeye. "The simulations allow us to peek inside what happens to produce over time, and the smartphone app puts that info into the hands of people who can use it, such as cold room managers or farmers. The goal is to add transparency at the point of sale, where it can make

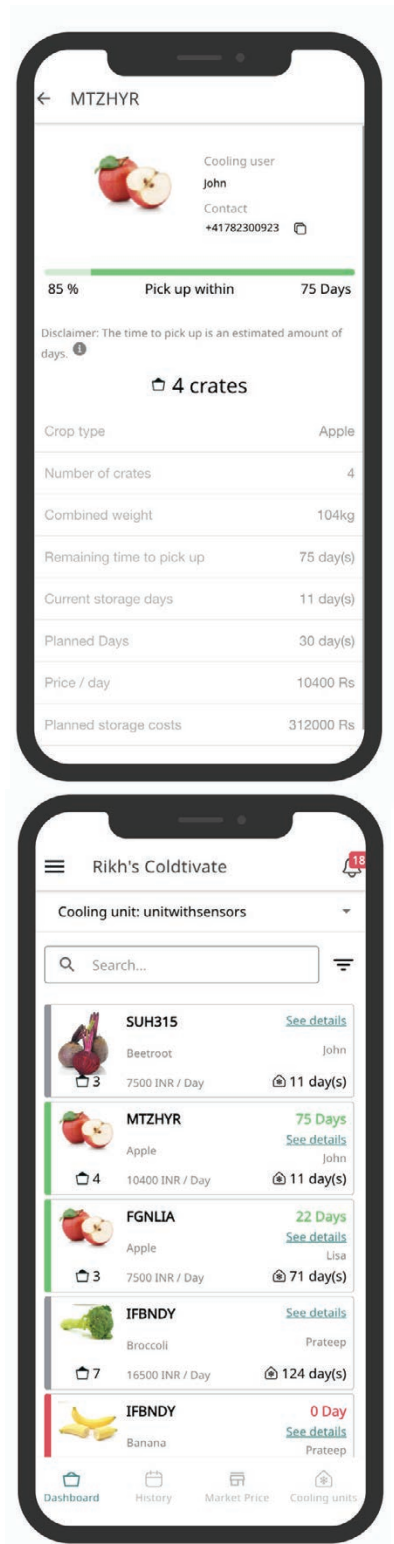

**FIGURE 4** The Coldtivate app showing relevant information about a farmer's crate in storage, including the remaining quality and expected shelf life.



a big difference. If the farmers and cold room operators can trust the forecast, that helps them trust each other as well."

### » COLDTIVATE IN THE FIELD

In August 2022, the Coldtivate app was released to selected cold room operators along with training on how to use the app to track produce in their facilities (Figure 6). To date, the simulation-powered app has been piloted in 17 cold rooms, serving more than 300 farmers, who are reporting a 20% increase in their incomes and a reduction of their post-harvest food losses by 20%. Empa and its partners are now working to expand Coldtivate's impact.

Future iterations of the app will deliver additional relevant info, such as market price forecasts, and even predictions of crop quality based on photos of produce. Now, BASE and Empa are working with organizations in Nigeria and the Philippines to bring Coldtivate's benefits to more of the world.

The scale of global post-harvest crop losses is daunting, but the coalition behind the Coldtivate project has proven that progress is within reach. "We're seeing how access to simulation-based predictive tools can improve access to cooling," Defraeye said. "Now we need more than incremental baby steps; we need bold action to expand our impact. We do this by putting technology into the hands of more people who can use it to make a difference." ☺

### ACKNOWLEDGEMENTS

The development of Coldtivate was funded partially by the data.org Inclusive Growth and Recovery Challenge grant "Your Virtual Cold Chain Assistant", supported by The Rockefeller Foundation and the Mastercard Center for Inclusive Growth, as well as by the project "Scaling up Your Virtual Cold Chain Assistant", commissioned by the German Federal Ministry for Economic Cooperation and Development (BMZ) and being implemented by BASE and Empa on behalf of the German Agency for International Cooperation (GIZ). The project team wishes to thank the main project partners, Koel Fresh Private Ltd., Oorja Development Solutions India Private Ltd., and ColdHubs Ltd., for their contribution in testing and fine-tuning the shelf-life model.

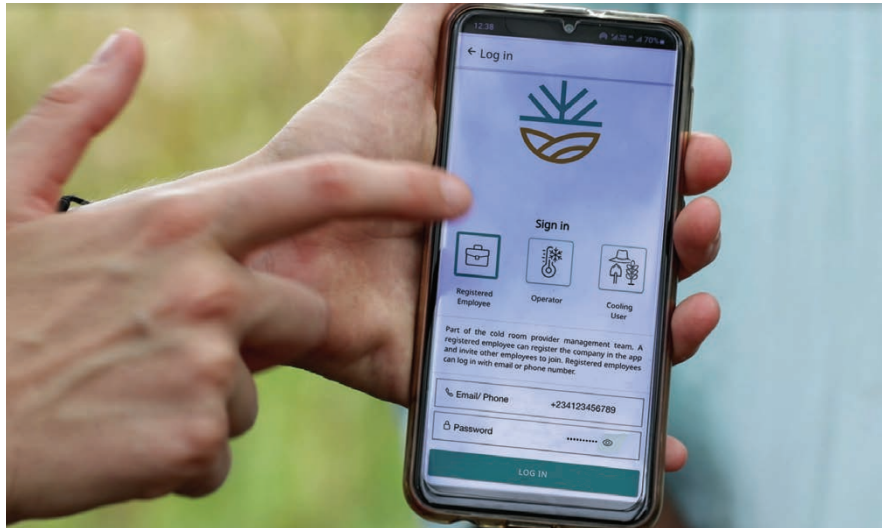

**FIGURE 5** The Coldtivate smartphone app in the hands of a user.



**FIGURE 6** Farmers and cold room operators in Odisha, India, attending app training.

**"Without the Application Builder, it would have been impossible to roll out the digital twins into a mobile app and democratize these multiphysics simulations, and their results, to a broader audience of beneficiaries, like smallholder farmers"**

— THIJS DEFRAEYE, SENIOR SCIENTIST AT EMPA

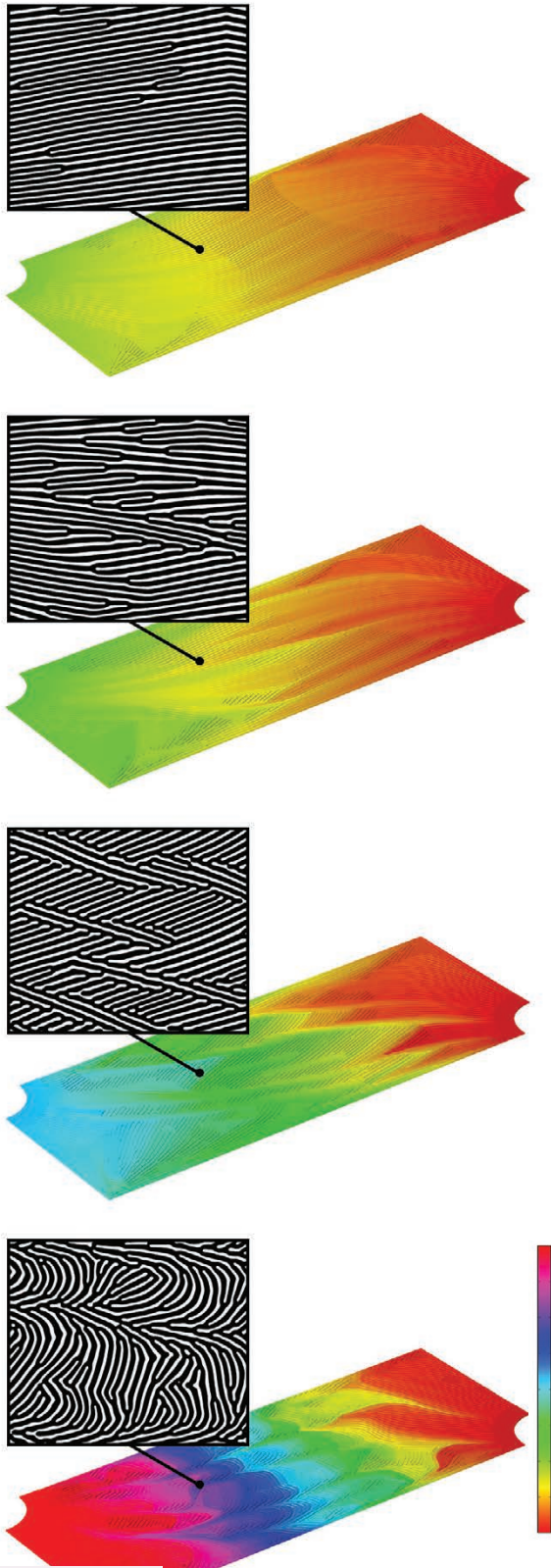

*Toyota Research Institute of North America, Michigan, USA*

# GENERATIVE DESIGN PUTS HYDROGEN FUEL CELL DEVELOPMENT IN HIGH GEAR

As an alternative to battery-electric vehicle drivetrains, Toyota is pursuing development of hydrogen–oxygen fuel cells. Toyota Research Institute of North America (TRINA) has developed a simulation-driven methodology for accelerating the R&D process for fuel cell flow field plates.

by ALAN PETRILLO

"Electrify everything." Among those seeking to reduce the world's reliance on fossil fuels, this phrase has become a rallying cry. We can see the electrification imperative in action all around us, as hybrid gas–electric vehicles (HEVs) and battery–electric vehicles (BEVs) are now familiar sights on the highway. But even as many automakers ramp up HEV and BEV production, one company is dedicated to developing electric cars that do not rely primarily on batteries for energy storage. Instead, these cars carry hydrogen, which provides electricity when combined with oxygen from the air inside a fuel cell. The company pursuing this alternate route is Toyota. The commercialization of hydrogen-fueled vehicles faces many obstacles, but if anybody can put the world on fuel cell-powered wheels, it could be the world's largest automaker.

**FIGURE 1** Simulation results from the TRINA team's model, built using the COMSOL Multiphysics® software, showing the pressure distributions resulting from four different microchannel flow field designs.



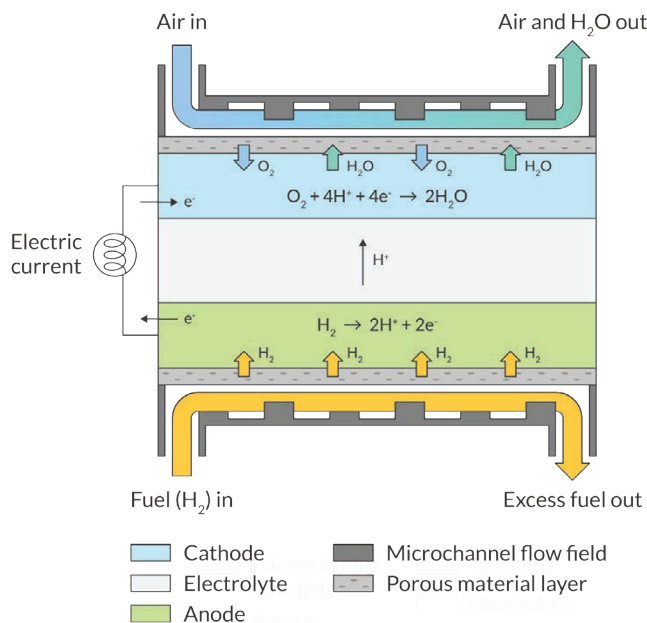
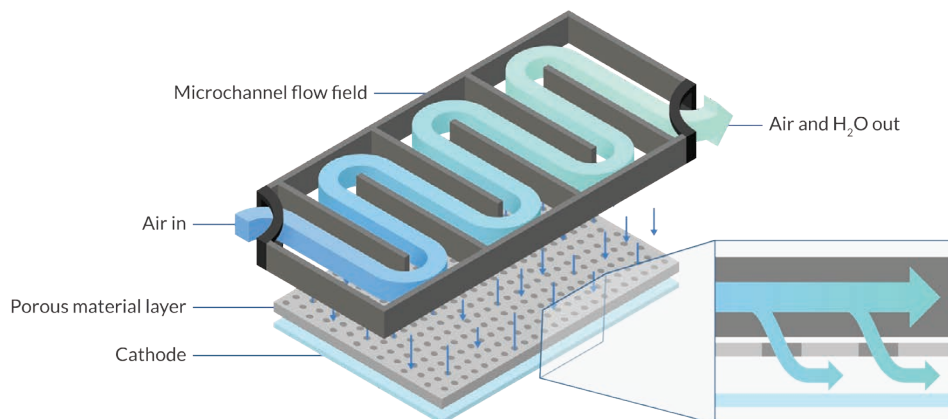

**FIGURE 2** A generic fuel cell design.

### » GENERATIVE DESIGN ENABLED BY SIMULATION

Toyota Research Institute of North America (TRINA) has developed a simulation-driven generative design method and applied it to the design of flow field microchannel plates, which direct the movement of fluid reactants in microreactors like hydrogen–oxygen fuel cells. While much of Toyota's fuel cell R&D is confidential, the TRINA team has published an article in *Chemical Engineering Journal* about their simulation-enabled "inverse design" process. Applying this process to flow field plates resulted in four distinctive microchannel designs (Figure 1).

Each of the four designs has particular merits; all of them outperform existing benchmark designs in terms of key metrics. Just as important, they exemplify the power of process. TRINA has shown how generative design enabled by



**FIGURE 3** A microchannel structure (shown in dark gray) defines a path through which reactant fluid moves. Some of the fluid is diverted away from the flow field through a porous material layer, toward the cathode surface.

simulation can accelerate innovation. "We think that the inverse approach can revolutionize current design practice," says Yuqing Zhou, a research scientist at TRINA.

### » CLEANER POWERTRAIN OPTIONS

While a hydrogen–oxygen fuel cell may seem like an exotic way to supply power to a car, the technology itself is not new, and its operation is appealingly straightforward. Figure 2 presents the fundamentals of a generic fuel cell in action. As hydrogen gas flows across the anode, it encounters a catalyst, which separates it into hydrogen ions and electrons. Whereas the hydrogen ions move through the electrolyte to reach the cathode, the electrons move through a conductor outside the fuel cell. It is this electric current that can be harnessed to perform useful work.

As oxygen gas from the air flows across the cathode, it encounters the hydrogen ions and returning electrons at the surface of the cathode. Here, the oxygen molecules split and combine with the hydrogen ions and electrons to form water.

### » A REACTANT'S PATH THROUGH A FLOW FIELD PLATE

For as long as hydrogen and oxygen keep flowing, a fuel cell will keep generating electric current. Managing the distribution of these essential gases is the job of the cell's flow field plates. Each plate includes both a microchannel structure and a porous sublayer. As hydrogen moves through the channels of the anode-side plate, it is also being forced through the sublayer toward the anode. Meanwhile, air is channeled through the flow field plate on the cathode side of the fuel cell. Air and water are exchanged through the cathode-side porous material layer, and the plate then channels excess air and water away from the cell stack. Figure 3 offers a simplified close-up of this essential process for the cathode side.

In their journal article, the TRINA team explains that "uniformity of fluid residence time or fluid flow distribution, and the relationship to optimal heat transfer, is directly related to the design of the flow structure, which is of primary importance for proper control of chemical reactions." Accordingly, the two main objectives for fuel cell flow field plate design are to maximize fluid flow across the plate's microchannel flow field and *through* the porous material layer, in order to supply sufficient reactant to the electrode.

### » A SIMPLER PROCESS FOR CREATING COMPLEX FORMAL SOLUTIONS

The physical arrangement of microchannels helps determine how well a flow field plate meets its performance objectives. Historically, microchannel

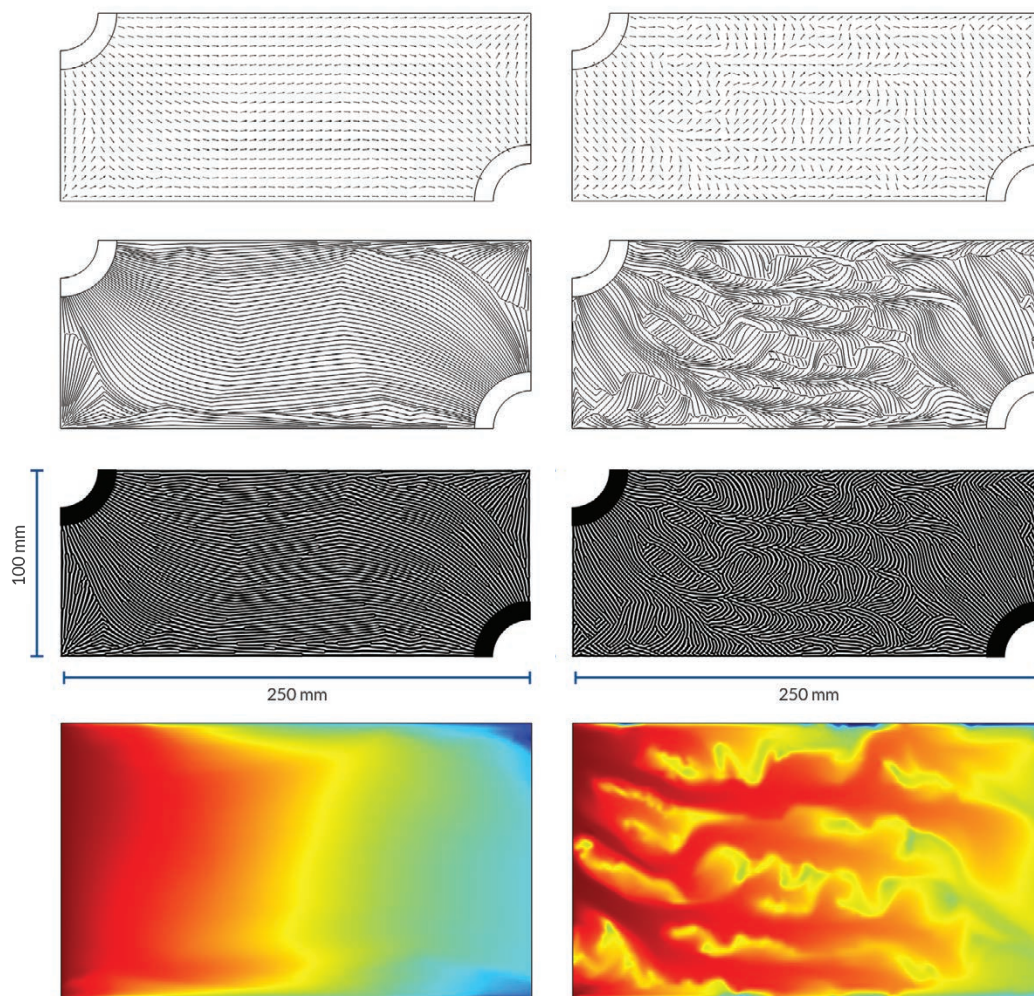

**FIGURE 4** Left: A flow-optimized microchannel design. Right: A reaction-optimized microchannel design, which features a mix of primary "arteries" and secondary "capillaries". The arteries sustain overall flow toward the outlet, while capillaries enable broader reactant distribution toward the electrode. In both cases fluid flows from the inlet at the upper left to the outlet at the lower right.

designs have followed a few familiar patterns. More complex forms could improve performance, but increasing a design's complexity adds to the time needed to define, fabricate, test, and adjust that design.

Zhou and his colleagues recognized that before trying to optimize their designs, they first had to optimize their design process. To generate a higher-performing formal solution to their problem, the team created their simulation-driven inverse design methodology. Their methodology does not define forms in advance of testing, but rather sets key parameters and then directs algorithms to generate forms that fulfill those parameters.

"We were seeking an efficient way of approximating what a more complex simulation would show. We have sacrificed some modeling complexity, which actually enables us to explore more elaborate designs in less time," Zhou says. "Some people use topology optimization for problems like this, and

they come up with designs that maybe have 10 channels. This is because they are asking their algorithm to determine the exact placement of every physical element of the channels in advance, which requires a lot of computing power and time to achieve a complex design," he explains.

#### » FROM DESIRED RESULTS TO NOVEL FORMS, FASTER

So how could the TRINA team use its methodology to efficiently generate better

microchannel designs? First, they simulated idealized flow trajectories through the effective anisotropic porous material, then they extracted values that described the idealized fluid behavior. Next, they input those values into another simulation, which generated the microchannel forms that would cause that behavior. Essentially, they defined the effect they wanted their designs to produce before designing anything.

Zhou explains, "Our COMSOL model of the porous material has only two material values and a very coarse mesh. We implement a sensitivity-based optimization process based on Navier–Stokes and advection–reaction–diffusion equations. We assume steady-state, incompressible, and laminar fluid flow through the porous media, and that the desired chemical reactions will occur proportionally to the reactant concentration. We run these simulations to arrive at an optimal distribution of fluid flow orientation through the pores. This process gives us valuable results with a huge reduction in computational complexity."

Zhou describes this part of the overall design process as *homogenization*. Having now established a pattern of ideal trajectories of fluid through the plate's pores, the next step is *dehomogenization*. This step involves the equation-driven definition of microchannel forms that will force fluid to follow these optimal paths.

#### » GENERATED DESIGNS THAT MAXIMIZE FLOW, REACTION, OR BOTH

The dehomogenization step is needed, Zhou says, because "we cannot fabricate an ideal porous material with each



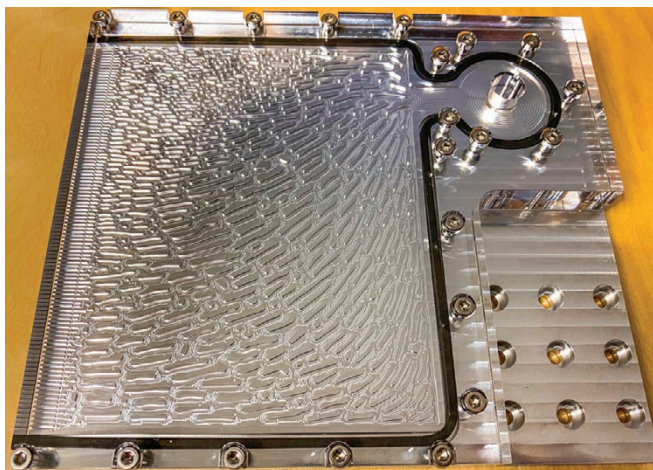

**FIGURE 5** A machined metal prototype flow field plate based on one of TRINA's generated designs.

pore individually designed. We need to install walls and channels to direct fluid through the pores in ways that approximate the ideal. To generate this design, we use COMSOL Multiphysics® to solve a customized partial differential equation (PDE) for pattern generation. The software also gives us plotting functions we can use to visualize the results."

Two of the formal options created by TRINA's dehomogenization equations are shown in Figure 4. Their guiding performance objectives are to reduce resistance to reactant flow and to enhance reactant supply and reaction uniformity across the entire plate. These objectives are represented by governing variables in the model's PDE. By assigning different weighting factors to these two objectives, Zhou and his team can induce the model to generate different design options. They can then evaluate the relative merits of each option and make adjustments to produce further iterations.

Of the design shown in Figure 4 at left, Zhou says, "We call this the 'flow design'

because it leads to the smallest pressure drop across the entire flow field surface. The model generated paths that are relatively parallel and straight, without much side branching."

While this design effectively moves fluid across the plate, it does less well at distributing reactant evenly through the porous material layer. Simulation shows lower reactant concentration on the outlet side of the design, which can limit reaction uniformity and the resulting power output from the fuel cell.

If the weighting factors in the governing equation were adjusted to prioritize reaction uniformity, the model would then generate a design like the one shown in Figure 5, which Zhou calls the "reaction design". High reactant concentrations (shown in red and orange in the bottom image) now predominate, indicating that a larger share of the available reactant is being put to work. The intricate forms of the "reaction design" microchannels may seem familiar to students of biology.

"Most commercial microreactors would use a design somewhat similar

## "Engineers might prefer to use straight channels with no side branching, but nature chooses the 'reaction design'."

— YUQING ZHOU, RESEARCH SCIENTIST, TRINA

to the 'flow design'," says Zhou. But naturally occurring systems that distribute fluid reactants — such as leaves, lungs, and blood vessels — more closely resemble the forms of Figure 4 at right.

"Engineers might prefer to use straight channels with no side branching, but nature chooses the 'reaction design'," Zhou says. The TRINA team's research paper notes that while some have previously experimented with natural-looking, fractal, or hierarchical forms selected *a priori* for flow field channels, "this is the first time that such large-scale branching flow fields have been discovered using an inverse design approach without assuming prescribed layouts."

### » RATHER THAN TRYING TO PREDICT THE FUTURE, CREATE IT

Along with the "flow versus reaction" comparison

illustrated earlier, TRINA produced two further designs (not shown) that combined attributes of those in Figure 4. Every one of TRINA's four iterations outperformed baseline conventional designs across key reaction-fluid performance metrics. An additional design that was fabricated and experimentally tested by the TRINA team is shown in Figure 5.

So, what is the ideal design for a flow field plate? There is no such thing, just as there is not a single ideal technology for replacing gasoline-powered automobiles. "From our point of view, we succeed by providing multiple good options for our engineers to consider," Zhou says. Yuqing Zhou shares some advice that guides him and his colleagues: "Our chief scientist has said: 'We must stop trying to predict the future, and just work on trying to create it.'"<sup>©</sup>

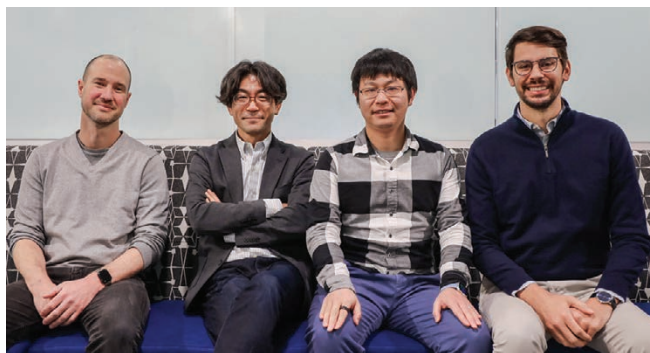

Four core contributors to the project. From left to right: Ercan M. Dede, Tsuyoshi Nomura, Yuqing Zhou, and Danny J. Lohan. Nomura is affiliated with Toyota Central R&D Labs in Japan, while the others work at Toyota Research Institute of North America.

COMSOL, Massachusetts, USA

# RF MEMS RESONATORS, THE BUILDING BLOCKS OF COMMUNICATION SYSTEMS

by JOSEPH CAREW

The development of MEMS resonators made the handheld devices we know today possible, as the mechanical resonators could be made much smaller than RLC circuits. The MEMS success story does not end there, of course: manufacturers are continuing to innovate, and the latest trend involves incorporating 5G communication functionality into these handheld devices. MEMS resonators are a big part of the process, and multiphysics modeling and simulation proves valuable for the continuous innovations in RF MEMS device designs.

In the development cycle, fabrication of MEMS device prototypes involves many costly processing steps. Multiphysics simulation speeds up the learning cycle while reducing the need for fabricating physical prototypes. Additionally, since the components are eventually integrated with electronic circuits, manufacturers also need to design the resonators as part of an electronics system, as opposed to designing them in isolation.

Today, RF MEMS are the building blocks of communication systems. Surface acoustic wave (SAW) resonators, operating at the lower range (e.g., 2.5 GHz), are the earliest examples of these devices. Bulk acoustic wave (BAW) resonators, a later development, were created to handle higher frequencies (e.g., 8 GHz) but feature a more complex design. Within this group of resonators, there are variants such as thin-film bulk acoustic resonators (TFBARs or FBARs) and solidly mounted resonators (SMRs). The lamb wave resonator (LWR) incorporates the interdigital transducers from SAW resonators and the suspended structure of the BAW resonators to achieve the advantages of both. The LWR design comes at the cost of even greater complexity, accentuating the role of multiphysics simulation, especially given the coupled electromechanical physics involved.

To show the benefits of using simulation in the RF MEMS device design process, we created three models using the COMSOL Multiphysics® software.

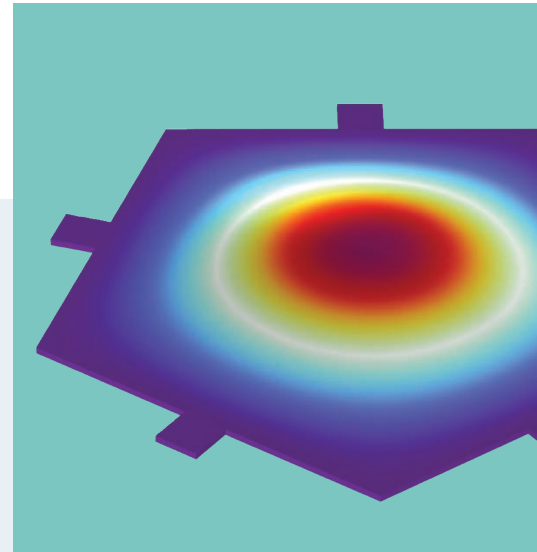

## THIN-FILM BULK ACOUSTIC RESONATORS

Today, most smartphones include some examples of an FBAR. For instance, an FBAR can be used in smartphone RF filters, which allow frequencies to be transmitted and received.

A multiphysics model of a five-sided, apodized FBAR design was developed with the goal of maximizing the confinement of vibrational energy. This particular model was designed to have a series resonance at about 3.25 GHz and is comprised of the following stacked components: a silicon nitride supporting layer, a molybdenum bottom electrode, an aluminum nitride piezoelectric layer, and an aluminum top electrode. The device is suspended from anchor points, or tabs, and the piezoelectric thin-film material (located between the pair of electrodes) is where the bulk acoustic wave is generated.

To realize an effective FBAR, the design phase requires careful simulation to predict the resonance frequency and other performance markers. The materials used as well as the overall layout of the FBAR contribute to its performance. Multiphysics modeling is an efficient way of evaluating designs before investing resources in fabricating physical prototypes.



## SOLIDLY MOUNTED RESONATORS

A type of FBAR, SMRs are robust and typically have higher resonance frequencies than their BAW counterparts. The acoustic mirror portion of these devices consists of alternating layers of materials with high and low acoustic impedances. This confines acoustic energy within the piezoelectric active layer. SMRs are also being used as RF filters as well as oscillators, actuators, and sensors.

The pictured SMR is a micromachined piezoelectric MEMS resonator formed on top of an acoustic mirror on a thick substrate. In this 2D model, there are alternating layers of molybdenum (high-impedance) and silicon dioxide (low-impedance) layers, but

actual configuration patterns can vary. The SMR's alternating layers add a level of complexity in the manufacturing process, and simulation can be used to optimize the thickness of the mirror materials to achieve maximum acoustic reflectivity and energy confinement. Simulation can also be used to see the impact of manufacturing variability on device parameters.

As the world transitions to 5G and anticipates 6G, design challenges intensify for both SMRs and FBARs. The demands for higher operating frequencies, wider bandwidths, and high Q factors necessitate accurate multiphysics simulations.

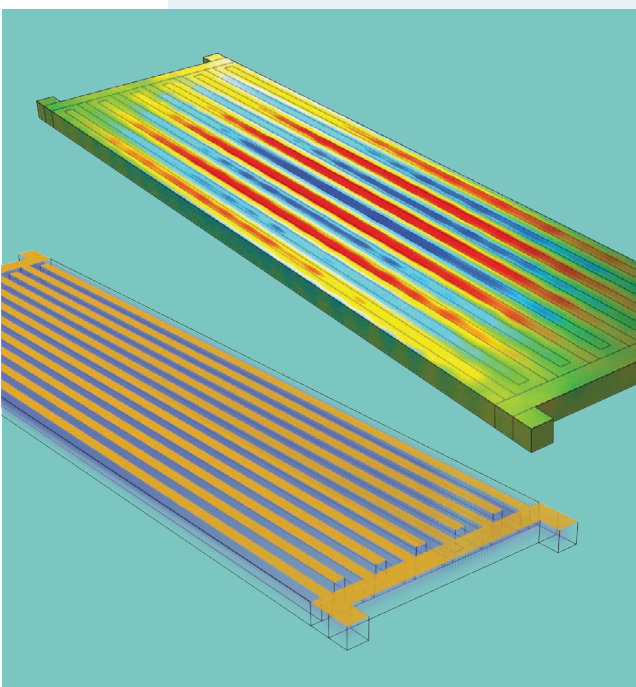
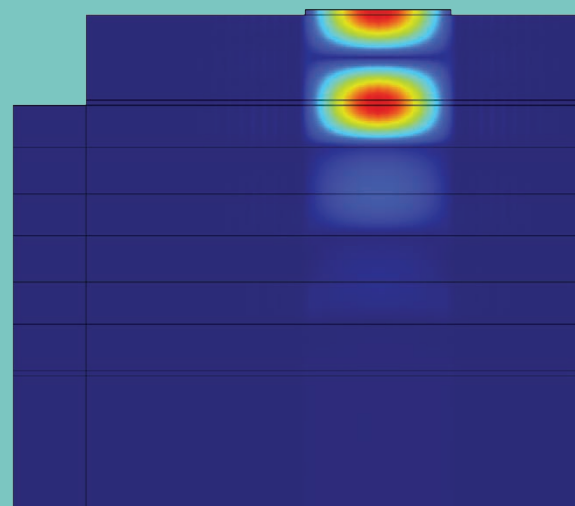

## LAMB WAVE RESONATORS

The LWR has attracted great attention because it combines the advantages of BAW and SAW resonators. It solves both the low resonance frequency limitation and integration problem that SAW resonators face and the multiple frequency capability problem faced by piezoelectric BAW resonators. Specifically, aluminum nitride (AlN) LWRs feature excellent power handling capability and high Q factors.

Informed by AlN's emergence as the best option for the transduction of acoustic waves, we built a multiphysics model of an AlN LWR. The LWR

remains relatively new on the scene of RF MEMS devices and is equally the most complex and capable of the devices presented here. In practice, the actual configuration pattern can vary, and LWRs may feature a variety of electrode configurations to achieve desired effects.

The complex relationship between electrode pattern and device performance makes for a challenging device to simulate. Additionally, loss mechanisms (e.g., anchor losses) can affect performance, which needs to be considered. Multiphysics simulation can address these needs.



*Heidelberg Materials, Norway and Sweden*

# BRINGING MULTIPHYSICS SIMULATION TO CONSTRUCTION SITES

Time, temperature, material selections, weather conditions, and casting technique can all affect the early-age performance of concrete used to construct buildings. To help its customers make informed decisions about how key variables will affect their projects, Heidelberg Materials provides access to predictive multiphysics modeling capabilities with a compiled simulation application.

by ALAN PETRILLO

Concrete is a fundamental part of countless structures, from modest homes to soaring bridges and skyscrapers. But for concrete to fulfill its promise of longevity, contractors must make the right decisions during the construction process. Their choices will affect the rate at which concrete hardens, or matures, which helps determine its long-term strength and durability.

Contractors can predict the potential outcome of a concrete casting process by using the maturity method, but it can be difficult to apply this technique in the field. This is why Heidelberg Materials, one of the world's largest suppliers of cement, aggregates, and precast and ready-mixed concrete, provides its customers in Sweden and Norway with the computer program they call HETT. They have participated in the development of multiple generations of HETT, but the new version is different: HETT<sup>22</sup> is a compiled simulation app

**FIGURE 1** To ensure the strength and durability of concrete structures, contractors must account for factors that affect concrete's early-age performance, including weather conditions.



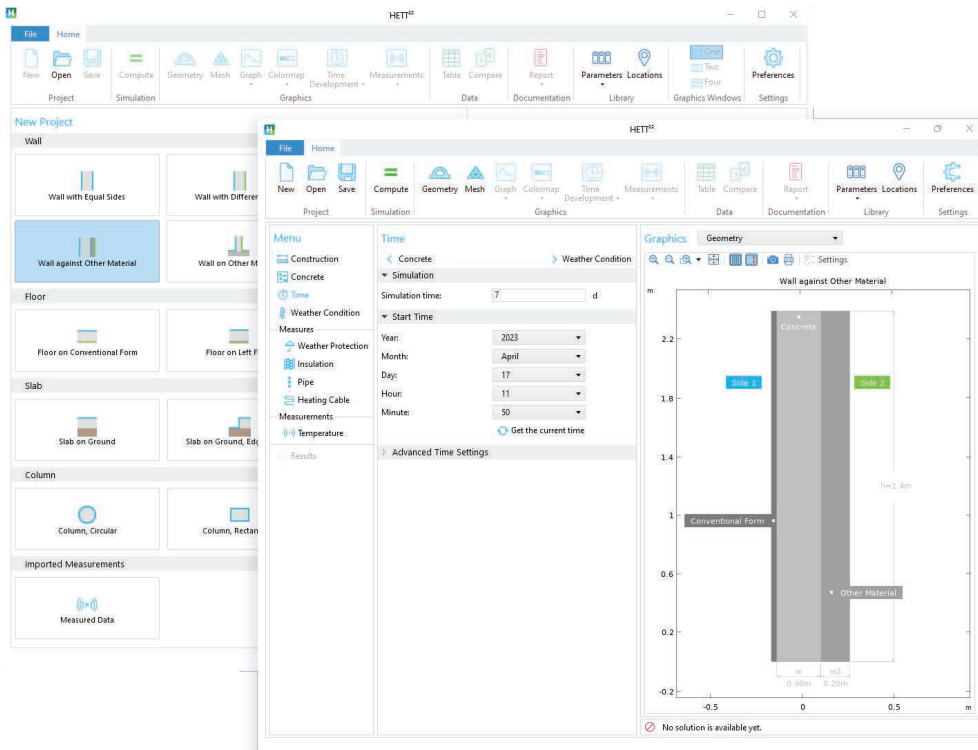

**FIGURE 2** The HETT<sup>22</sup> app showing the construction of a sample model.

that provides timely access to forecasts based on multiphysics models that account for site conditions, ambient temperatures, material selections, and other relevant variables.

HETT<sup>22</sup> and its associated models were created for Heidelberg Materials by Deflexional, a COMSOL Certified Consultant that specializes in using the COMSOL Multiphysics® software to build multiphysics models and simulation apps. After using the Application Builder to turn the models into a custom app, Deflexional used COMSOL Compiler™ to deploy it. In just six months after launch, HETT<sup>22</sup> was downloaded more than 1100 times.

"HETT<sup>22</sup> helps you evaluate options from different perspectives," says Mikael Westerholm, project manager for the HETT program at Heidelberg Materials' Cement Sverige (formerly the company Cemente). By using simulation to predict potential outcomes of the early-age maturity process, contractors can be more confident in the choices they make regarding construction alternatives — before their decisions are effectively set in stone.

### » TIME, TEMPERATURE, AND THE TRADEOFFS OF CEMENT HYDRATION

While multiple factors can affect the chemical processes that control the maturity and strength development of concrete, temperature plays an especially significant role.

"Cement hydration, which is the chemical reaction between cement and water, develops a lot of heat," explains Tom Fredvik, technical manager at Heidelberg Materials' Sement Norge (formerly the company Norcem). "This leads to temperatures rising during the hardening process, and the

rate of cement hydration is very temperature-dependent. Higher temperatures lead to faster hydration and strength development."

Rapid hydration is not necessarily desirable. Concrete that cures quickly in hot weather is likely to be weaker than concrete that matures more slowly under cooler conditions. Conversely, below-freezing temperatures can also impair strength development. "It is very important to account for these effects, especially when casting in the wintertime," says Fredvik. "In the worst case, the concrete may suffer permanent frost damage if it freezes before gaining sufficient strength."

Contractors can insulate the formwork and cover free concrete surfaces with insulating materials to mitigate freezing risks, or even add heat from external sources. Such techniques must be

applied judiciously to avoid overheating, premature drying, or significantly increasing construction project costs.

### » ESTIMATING STRENGTH DEVELOPMENT WITH THE MATURITY METHOD

Before committing to a thermal management strategy, contractors can use the maturity method to predict the potential outcome of a particular project. "The maturity method [...] has been used for more than 50 years to estimate how temperature affects concrete strength development," says Westerholm. "It is a nondestructive way to predict strength, which can otherwise only be determined by analyzing core samples after the concrete is cast."

The maturity method combines known metrics with site- and project-specific data. The values for the maturity function and the reference strength of a concrete mix can be obtained in advance but the temperature to which the concrete will be exposed must be estimated. This estimated temperature curve should account for ambient temperatures and the internal heat generated by cement hydration. Actual temperature levels will not evolve uniformly throughout the entire volume of a particular concrete casting, which means that strength can develop unevenly as well.

### » PUTTING MULTIPHYSICS SIMULATION INTO THE HANDS OF CONTRACTORS

To support wider access to the predictive potential of simulation, Heidelberg Materials engaged Deflexional to create the latest version of HETT. "When the team from

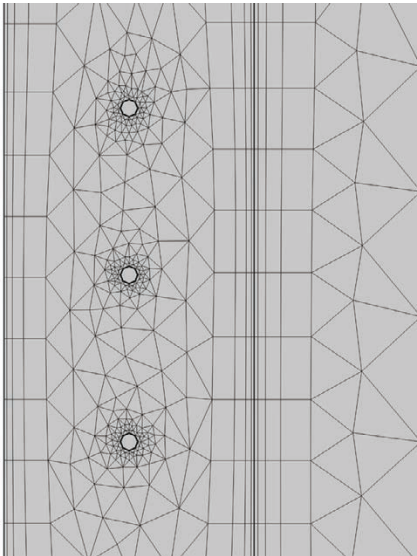

**FIGURE 3** 2D boundary layer meshing of a wall model.

Heidelberg explained their goals, we saw a great opportunity to expand HETT's usefulness," says Daniel Ericsson, CEO at Deflexional. HETT<sup>22</sup> is the first generation of the program to be developed using the Application Builder in the COMSOL Multiphysics software and compiled using COMSOL Compiler.

"With HETT<sup>22</sup>, one of our goals was to be as user-friendly as possible," says Fredvik. "We have also added new features that enable our customers to consider real-world conditions in more detail."

A brief walkthrough of a hypothetical concrete casting project demonstrates HETT<sup>22</sup>'s expanded capabilities (Figure 2). The app user starts by selecting from a list of typical cases representing different construction scenarios and then defines the casting geometry parameters, material mix, strength class of concrete, time frame, and expected weather conditions. The model accounts for how the physical surroundings of a casting may affect its behavior.

"In a situation where a new concrete form is cast on an existing slab, the connection between new and old castings is very critical," says Fredvik. "HETT<sup>22</sup> gives us the ability to analyze what is happening around that joint." Other relevant physical attributes that may affect the temperature and strength development of concrete, such as the presence of heating cables or heating/cooling pipes inside a casting, can be incorporated into the model. The geometry of the model and its mesh is shown in Figure 3.

After defining the formwork and geometry, the user can integrate site-specific weather forecasts for the planned casting (Figure 4). Forecasts for the entire world can be automatically downloaded and transformed into appropriate boundary

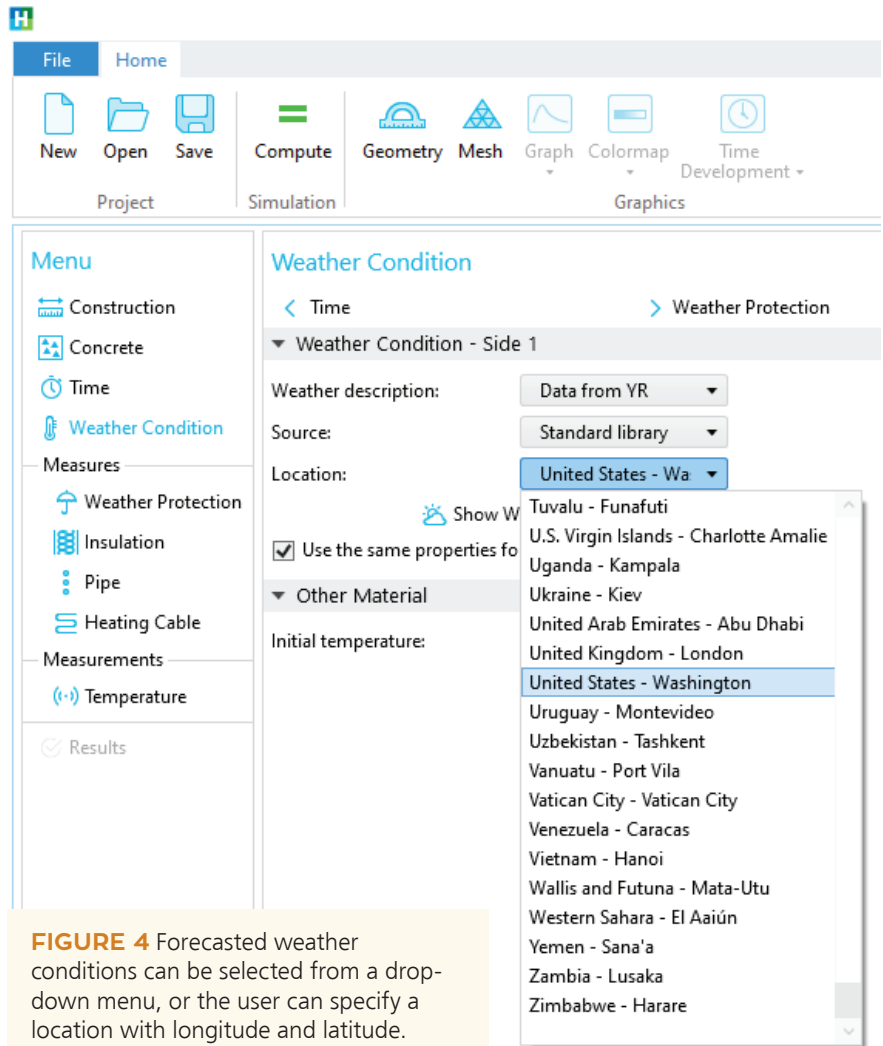

**FIGURE 4** Forecasted weather conditions can be selected from a drop-down menu, or the user can specify a location with longitude and latitude.

conditions for the model.

"Along with selecting a forecast in advance, we can also provide HETT<sup>22</sup> with *in situ* recorded temperatures during the curing period and then make adjustments if measured conditions are significantly different from what was expected," Fredvik says.

Time constraints and desired strength are key influences on a user's choice of materials. "In this example, the strength requirement is set to 15 MPa before we can remove the formwork," says Westerholm, "so we choose a concrete with appropriate strength development from the preinstalled library.

A user can also choose supplementary cementitious materials to be mixed with the concrete. These materials may include fly ash, granulated blast furnace slag, and silica fume," he explains.

These materials are by-products from other industries, such as energy production and the processing of iron and ferrosilicon. The use of supplementary materials in cement or as additives to concrete helps lower the overall carbon footprint of concrete construction. "Reducing CO<sub>2</sub> emissions is a focus of the concrete industry worldwide," says Westerholm. "But these



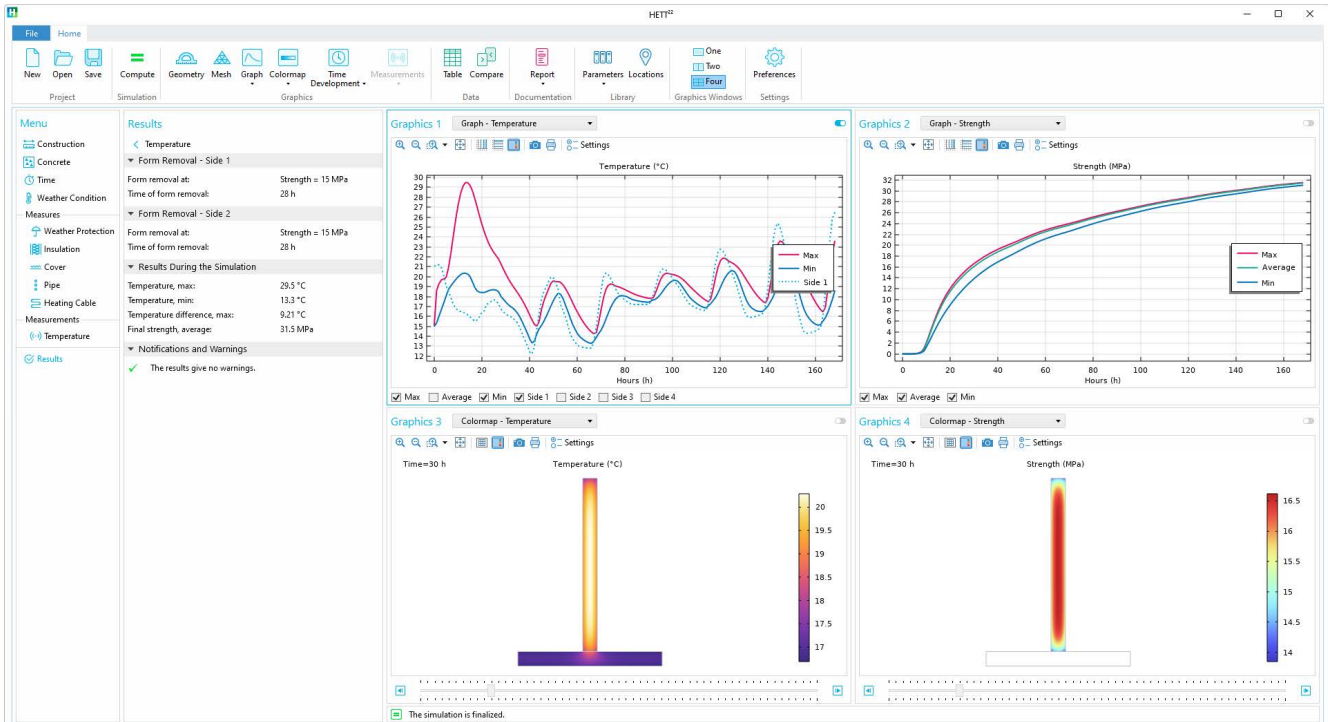

**FIGURE 5** Simulation results showing the temperature and strength of a concrete casting.

alternative materials may slow down hydration and have different strength development characteristics. We wanted HETT<sup>22</sup> to help users predict the behavior of concrete that they may not be familiar with."

**» SIMULATION RESULTS GUIDE PREEMPTIVE ADJUSTMENTS**

Running the app powered by COMSOL models yields predicted values for the characteristics that determine how long it will take to achieve the desired strength — in this example, 15 MPa — before form removal. "We can track expected temperatures for the surrounding air and soil and forecast a temperature curve for the

concrete itself," says Fredvik. (Figure 5) "Based on our temperature development, we can calculate that it will take about 30 hours for the entire casting to reach the strength that we need." If that is too long for this particular job, then HETT<sup>22</sup> can show the potential effect of different concrete selections on the estimated time for form removal. Builders can select different options from a menu of Heidelberg Materials' concrete products as well as review details about the performance characteristics of each option directly in the simulation app.

What if actual weather conditions differ from the forecast? In that case, users can adjust temperature values to see how that may

affect strength development. "If air and windspeed change significantly, we can potentially remove our formwork sooner than expected," Fredvik says.

**» MULTIPHYSICS SIMULATION SUPPORTS COST-BENEFIT ANALYSES**

By predicting the effects of choices related to physical conditions, a construction team can use a compiled simulation app to better manage the economics and carbon footprint of each project. For example, if the weather forecast shows that a casting with a low-carbon concrete will take too long due to cold temperatures, the contractors will be confronted with potential cost-benefit tradeoffs.

"Should you switch to a faster-curing cement or a higher strength class of concrete, even if it is more expensive and potentially

results in a higher carbon footprint?" Westerholm questions. "Or is it possible to stick with your initial plan, and instead take steps to insulate or warm up your formwork?"

Heidelberg offers its customers hundreds of potential concrete recipes; from the company's perspective, the simulation app is a necessary complement to a potentially daunting array of options. The predictive modeling capability of the COMSOL Multiphysics software, when presented through the app's custom interface, helps users make informed decisions more efficiently.

"This is why we provide HETT<sup>22</sup> to our customers," says Fredvik. "Because of the value it adds for them at each decision point of a concrete casting job, we see it as a core part of our tech support offering." ☺

**"It is a nondestructive way to predict strength."**

— MIKAEL WESTERHOLM, PROJECT MANAGER, HEIDELBERG MATERIALS

INFICON, Liechtenstein

# ELEVATING THE PERFORMANCE OF IONIZATION GAUGES WITH SIMULATION

To develop a better ionization gauge for measuring pressure in high-vacuum or ultra-high-vacuum (HV/UHV) environments, instrument manufacturer INFICON of Liechtenstein used multiphysics modeling to test and refine their new design.

by ALAN PETRILLO



**FIGURE 1** The IRG080. Image provided by INFICON.



**FIGURE 2** A Bayard–Alpert hot-filament ionization gauge. Image provided by INFICON.

Innovation often becomes a form of competition. It can be thought of as a race among creative people, where standardized tools measure progress toward the finish line. For many who strive for technological innovation, one such tool is the vacuum gauge.

High-vacuum and ultra-high-vacuum (HV/UHV) environments are used for researching, refining, and producing many manufactured goods. But how can innovators be sure that pressure levels in their facility's vacuum chamber are truly aligned with those in other facilities? Without shared standards and reliable tools for meeting these standards, key performance metrics — for both the vacuum chambers and the products being tested — may not be comparable.

## » GLOBAL COMPETITION YIELDS WINNING PROTOTYPE

The Ion Reference Gauge 080 (IRG080), designed and produced by INFICON, is the result of a multinational project to develop a better tool for quantifying pressure in HV/UHV environments.

The development of this sensor was coordinated by the European Metrology Programme for Innovation and Research (EMPIR). EMPIR is a collaborative effort by private companies and government research organizations to help make Europe's "research and innovation system more competitive on a global scale". The project participants considered multiple options before agreeing that INFICON's design best fulfilled the performance goals.





**FIGURE 3** INFICON's IE514 physical gauge.

### » DETERMINING GAS DENSITY THROUGH IONIZATION

"There are almost no high-tech products that do not involve a vacuum process," says Martin Wüest, head of sensor technology at INFICON.

The term "vacuum" can describe a theoretical absolute of absence, but the emptiness of an actual space is usually a matter of degree. Measuring different degrees of vacuum calls for various methods for determining pressure levels.

"At near-atmospheric pressures, you can use a capacitive diaphragm gauge," says Wüest. "At middle vacuum, you can measure heat transfer occurring via convection." Neither of these approaches is effective at HV or UHV pressure levels.

"At HV/UHV pressures, there are not enough particles to force a diaphragm to move, nor are we able to reliably measure heat transfer. This is where we use ionization to determine gas density and corresponding pressure," Wüest explains.

The most commonly used HV/UHV pressure-measuring tool is a Bayard–Alpert hot-filament ionization gauge (Figure 2), which is placed inside the vacuum chamber. This instrument includes a filament, grid, and ion collector. Its operation starts with supplying low-voltage electric current to the filament, causing it to heat up. As the filament becomes hotter, it emits electrons that are attracted to the grid, which is supplied with higher voltage. Some of the electrons flowing toward and within the grid will collide with free-floating gas molecules that

are circulating in the vacuum chamber. Electrons that collide with gas molecules will form ions that flow toward the collector. This measurable ion current in the collector will be proportional to the density of gas molecules in the chamber.

"We can then convert density to pressure, according to the ideal gas law," Wüest said. "Pressure will be proportional to the ion current divided by the electron current, divided by a sensitivity factor that is adjusted depending on what gas is in the chamber."

### » EXISTING GAUGES ARE SENSITIVE TO HEAT AND ROUGH HANDLING

Something to note about Bayard–Alpert ionization gauges is that their calibration is easily compromised by routine handling.

"A typical ionization gauge contains fine metal structures that are held in spring-loaded tension," says Wüest. "Each time you use the device, you heat the filament to between 1200 and 2000°C. That affects the metal in the spring and can distort the shape of the filament. This changes the starting location of the electron flow and the paths the electrons follow."

Along with their sensitivity to heat, the core components of a Bayard–Alpert gauge can become easily misaligned. This can introduce measurement uncertainty of 10 to 20%. "Most vacuum chamber systems are overbuilt as a result," Wüest says, and the need for frequent gauge recalibration also wastes development time and money.

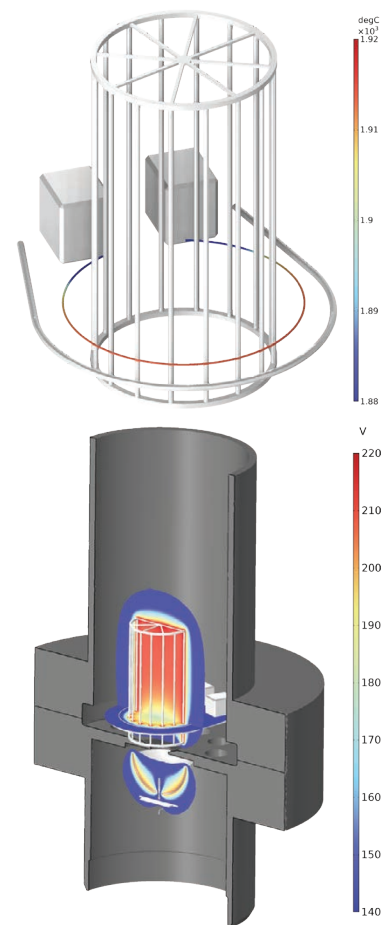
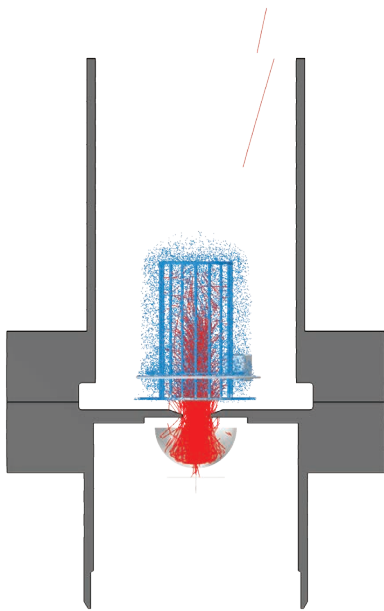

**FIGURE 4** IE514 simulation results showing the filament temperature (top) and the electric potential surrounding the grid structure (bottom).

### » BUILDING A SIMULATION MODEL OF A BENCHMARK DESIGN

The project team set a measurement uncertainty target of 1% or less for when the gauge is used to detect nitrogen gas. Another goal was to eliminate the need to recalibrate gas sensitivity factors for each gauge and gas species being detected. The new design's performance needed to be unaffected by minor shocks and reproducible by multiple manufacturers.

To achieve these goals, the project team first dedicated itself to studying HV/UHV measurement. Its research encompassed a broad review of 260 relevant studies. After completing their review, the project partners selected one design that incorporates current best practice for ionization gauge design: INFICON's IE514 extractor-type



**FIGURE 5** Ray tracing models showing the simulated paths of electrons (blue) and ions (red) in the IE514.

gauge. INFICON and two other project participants, NOVA University Lisbon and the European research lab CERN, each developed simulation models of the IE514 design. The results generated by each model were compared to test results from a physical prototype of the IE514 gauge to ensure the models' accuracy before proceeding with new designs.

Francesco Scuderi, an INFICON engineer, used the COMSOL Multiphysics® software to model the IE514 (Figure 3). The model enabled analysis of thermionic electron emissions from the filament and the ionization of gas by those electrons. The model can also be used for ray tracing the paths of generated ions toward the collector. With these simulated outputs, Scuderi could calculate an expected sensitivity factor, which is based on how many ions are detected per emitted electron — a useful metric for comparing the overall fidelity of the model with actual test results.

"After constructing the model geometry and mesh, we set boundary conditions for our simulation," Scuderi explains. "We are looking to express the coupled relationship of electron emissions and filament temperature, which will vary from approximately 1400 to 2000°C across the length of the filament. This variation thermionically

affects the distribution of electrons and the paths they will follow." (Figure 4)

"Once we simulate thermal conditions and the electric field, we can begin our ray tracing simulation," Scuderi continues. "The software enables us to trace the flow of electrons to the grid and the resulting coupled heating effects." Next, the model is used to calculate the percentage of electrons that collide with gas particles. From there, ray tracing of the resulting ions can be performed, tracing their paths toward the collector (Figure 5).

"We can then compare the quantity of circulating electrons with the number of ions and their positions. From this, we can extrapolate a value for ion current in the collector and then compute the sensitivity factor," says Scuderi.

INFICON's model simulated values that closely aligned with test results from the benchmark prototype. This enabled the team to observe how changes to the modeled design affected key metrics, including ionization energy, the paths of electrons and ions, emission and transmission current, and sensitivity.

### » SIMULATION LED TO A MORE ROBUST GAUGE

The end product of INFICON's design process, the IRG080, incorporates many of the same components as existing Bayard–Alpert gauges, but key parts look quite different. For example, the new design's filament is a solid suspended disc, not a thin wire. The grid is no longer a delicate wire cage but is instead made from stronger formed metal parts. The collector now consists of two components: a single pin or rod that attracts ions and a solid metal ring that actually helps direct electron flow away from the collector and toward a Faraday cup. This arrangement, refined through ray tracing simulation with the COMSOL Multiphysics software, improves accuracy by better separating the paths of ions and electrons.

Testing showed that the IRG080 achieved the goal of reducing measurement uncertainty to below 1%. In regard to sensitivity, the IRG080 performed eight times better than the benchmark. Just as importantly, the INFICON prototype yielded consistent results during multiple testing sessions, delivering sensitivity repeatability performance that was 13 times better

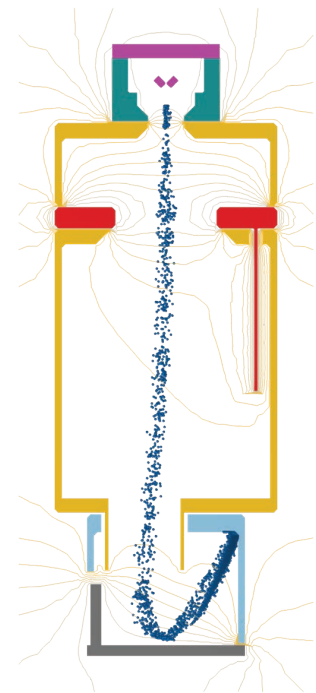

**FIGURE 6** The COMSOL model of the IRG080 gauge.

than that of the benchmark gauge. Twenty-three identical gauges were built and tested during the project, confirming that INFICON had created a more precise, robust, and reproducible tool for measuring HV/UHV conditions.

At the completion of the ion gauge project, the INFICON team hoisted an impressive trophy: the IRG080 itself. Of course, this success was not the team's alone. INFICON benefited from its partners' support; in turn, the broader scientific and manufacturing community will benefit from more consistent measurements of HV/UHV conditions. ©

### ACKNOWLEDGEMENTS

Participants of the EMPIR ionization gauge project include Physikalisch-Technische Bundesanstalt, Cesky Metrologicky Institut Brno, Institut za Kovinske Materiale in Tehnologije, Laboratoire national de métrologie et d'essais, RISE Research Institutes of Sweden AB, European Organization for Nuclear Research, Faculdade de Ciências e Tecnologia Universidade Nova de Lisboa, VACOM Vakuum Komponenten & Messtechnik GmbH, and INFICON Aktiengesellschaft.



COMSOL, Massachusetts, USA

# THERMAL MODELING OF SMALL SATELLITES

by WALTER FREI

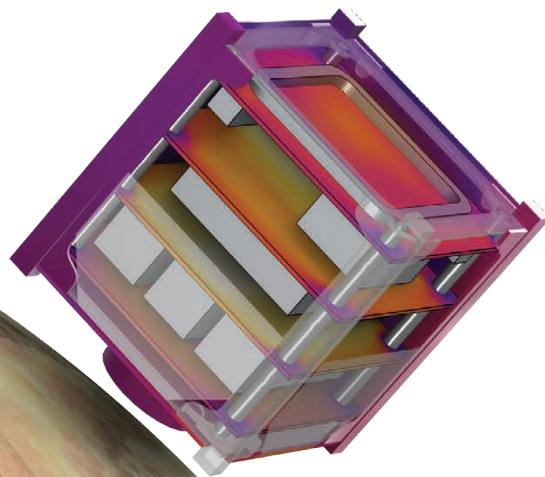

**FIGURE 1** A heat transfer simulation of a satellite in orbit, showing the temperature distribution. Earth image credit: Visible Earth and NASA.

Over the last few years, there has been a dramatic increase in the number of satellites in orbit. A significant portion of this increase is thanks to the smaller size of newer satellites. Although the largest orbiting structure, the International Space Station, is larger than a football field, most of the satellites in orbit today are much closer in size to a football. This is in part due to the popularity of the CubeSat form factor, with a so-called 1U satellite fitting within a 10-cm x 10-cm x 10-cm envelope. The small size makes it possible to launch multiple satellites from a single rocket. Although originally envisioned for mostly academic purposes, there is now a robust commercial ecosystem providing design solutions ranging from 1U to 24U — and the use of CubeSats is growing at a remarkable rate.

One of the characteristics of the CubeSat designs (and other small satellite designs) is that they are very compact. Many miniaturized cameras, sensors, instruments, antennas, batteries, attitude control systems, and other electronics are closely packed and can generate waste heat. Designing the satellite to properly radiate this heat to surrounding space is

one of the primary engineering concerns. Engineers must ensure that the various electronic components stay within certain temperature ranges, but this can be challenging, as thermal gradients can lead to undesirable structural deformations. Since it is quite difficult to do any kind of truly realistic preflight testing, the design process has to rely heavily on numerical modeling.

Once the satellite is in orbit, it might be tempting to think that the numerical model is no longer needed, but this is not true. Components will fail, often for unknown reasons, and the remaining electronics may need to be driven in unanticipated combinations. The satellite operator still needs the thermal model to predict behavior in such circumstances, with the objective of increasing operational lifetime.

## » WORKING WITH NUMERICAL MODELS

Numerical models all involve solving an approximation of the governing equations describing heat transfer. They can range from being very simple models to nearly full-fidelity models that include

many of the geometrical and physical aspects. The most simplistic numerical model would reduce the geometric complexity of the satellite structure and only compute, in a lumped sense, a single temperature over time for the satellite. From there, one could work toward introducing temperature variations across various subsystems or components of the satellite. This would require the numerical analyst to introduce many approximations, assumptions, and separate calculations into their model.

On the other hand, a full-fidelity model is based directly on the CAD design and takes the opposite approach. By starting directly with the CAD design, much of the tedious manual validation and verification of each simplification that goes into a reduced model is obviated. Of course, working directly with the CAD is going to lead to a greater computational cost: A CAD-based numerical model will subdivide the geometry of the satellite into thousands, or even millions, of different computational elements, so there is a tradeoff.

Historically speaking, the lumped modeling approach had a lot going for it.

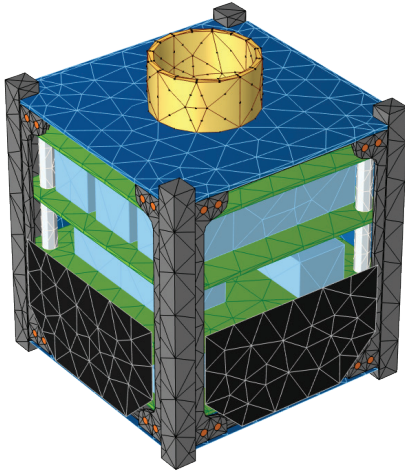

**FIGURE 2** Imported CAD geometry and the resultant finite element mesh after some defeaturing and simplification.

Computers used to be relatively slow, so having the numerical analyst spend time semimanually reducing the computational complexity was important for getting results quickly. This approach is still relevant for the modeling of very large structures like the International Space Station, but for small satellites — especially as computational costs continue to drop — it is now becoming increasingly attractive to start at the other end of the modeling spectrum.

In practice, a thermal analyst will want to work somewhere on the spectrum between a wholly simplified and a full-fidelity model. For example, it might be desirable to replace the CAD description of each screw and fastener with a lumped thermal resistance at the surface between the joined components. Similarly, it might make sense to reduce an electronic component such as a chip or battery to a block of material with averaged properties and internal dissipation.

## » IMPORTANT MODELING CONSIDERATIONS

Regardless of the modeling approach taken, certain aspects need to be considered. Let's explore these points in more detail.

**The geometric description of the satellite.** The CAD design and thermal properties (thermal conductivity, density, and specific heat) of the materials being used in each component determine the



**FIGURE 3** A visualization of a satellite in orbit, showing the position and orientation relative to the Sun and Earth as well as the irradiation onto the satellite's exposed faces. Earth image credit: Visible Earth and NASA.

total thermal mass of the satellite as well as the conductive heat transfer between parts. The relative orientation of the satellite faces also determines the view factors, describing how well one surface can see another surface. This is needed when computing radiative heat transfer. Along with the CAD design, there is additional information that is related to the geometry. For example, the mating surfaces between two parts might have a thin coating, or a bonding material, that alters the thermal contact resistance. The total resistance can also be a function of contact pressure, as determined by the mounting hardware.

**The emissivities of all exposed surfaces.** Emissivity (or absorptivity) is a measure of how well a surface emits and absorbs thermal radiation. It can be a function of wavelength, temperature, and angle of incidence. The combination of the view factors and surface emissivities is used to compute the radiative heat exchange. There is radiation both on the exterior surfaces of the satellite and within the interior. The exterior surfaces also experience environmental heat loads, such as the thermal irradiations from the Sun and Earth. It is particularly worth understanding the topic of wavelength-dependent emissivities. The Sun is the primary source of heating and the only

source of electrical energy, via solar cells. The light from the Sun is classified as short-wavelength light, with peak intensity at the 500-nm wavelength and with most energy in the sub-5- $\mu\text{m}$  wavelength range. The satellite itself is much colder than the Sun and emits thermal radiation at much longer wavelengths, primarily at wavelengths greater than 2  $\mu\text{m}$ . Because of this, it is very common to use thermal coatings that are strongly wavelength dependent. A coating with low emissivity at shorter wavelengths will reduce solar heating, but if that same coating has higher emissivity at longer wavelengths, it will radiate heat more effectively.

**The satellite orbit.** Defined by the standard Keplerian orbital elements, the satellite orbit determines how the satellite travels around Earth and when it goes into and out of eclipse. When the satellite goes into eclipse, there is no longer any solar irradiation, which usually leads to significant drops in temperature on the exterior surfaces. For thermal modeling purposes, the orbit itself can typically be treated as periodic, especially in the context of small satellites in low Earth orbits.

**The satellite orientation.** This information determines which faces see the Sun, Earth, or deep space. The satellite may be pointing in a particular direction, spinning about its axes, or even have parts of the structure that are rotating and moving relative to the satellite frame. This information affects the irradiation onto the exposed faces. The orientation, unlike the orbit, might not be periodic. For example, a satellite antenna might be pointed toward a ground station only every few orbits.

**The radiative properties of Earth and Sun.** The solar flux varies throughout the year, and this solar flux is both directly incident on the satellite and also diffusely reflected from Earth. The magnitude of this reflection, known as the albedo, can vary over the planet surface. Earth itself is also a radiator of infrared light, and this radiated flux can be a function of latitude and longitude. Although solar flux is well known, the albedo and Earth infrared radiation also vary significantly over the planet's surface and over time.

**The electrical dissipations of the components.** The solar cells convert



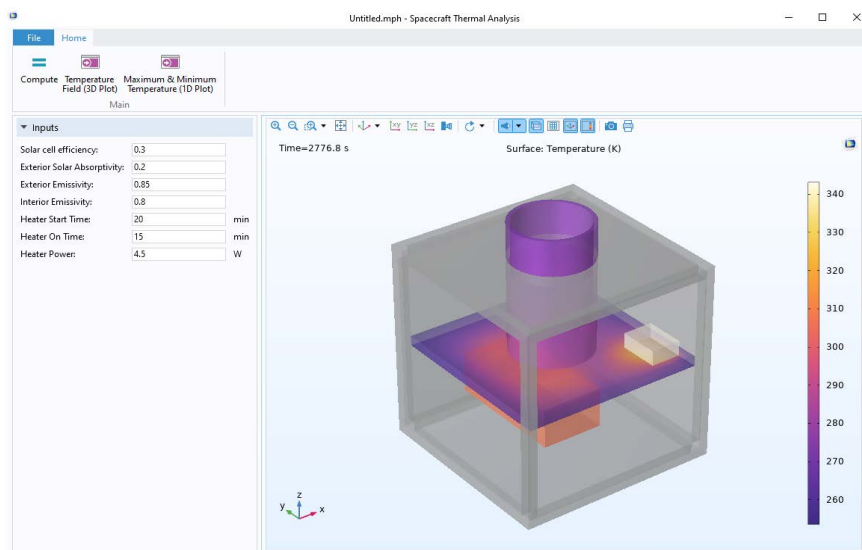

**FIGURE 4** A simulation application showing the computed temperature variation of a cube satellite.

incident light into electrical energy, which is used to charge the batteries that drive the electronics. These various electronics all dissipate heat while in operation, and these components may be on continuously, on at specific predetermined times, or switched on in response to specific conditions. For example, a heater can be controlled by a thermostat to hold a component within a desired temperature range.

Accounting for all of these elements while modeling requires the use of efficient and reliable multiphysics simulation software, such as COMSOL Multiphysics®.

## » SATELLITE MODELING IN COMSOL®

The Heat Transfer Module, an add-on to COMSOL Multiphysics, includes a dedicated user interface for satellite modeling: the *Orbital Thermal Loads* interface. Based on a hybrid finite-element-radiosity method, the functionality of this interface enables engineers to use a CAD-centric approach to build near-full-fidelity models of small satellites. The interface is seamlessly integrated into the COMSOL product suite and offers a simple way to define material properties, loads, and boundary conditions, extract results, and define physics couplings for multiphysics simulations. The Heat Transfer Module also has functionality for modeling

fluids, phase change materials, heaters, and thermoelectric effects, as well as for lumped system modeling.

The *Orbital Thermal Loads* interface provides a convenient way to define and verify the orbit and orientation as well as Sun and planet properties. From there, it computes the solar, albedo, and Earth infrared irradiation using a two-band radiation model, with a user-selectable division between the solar (short-wavelength) and ambient (long-wavelength) bands. This allows for specifying different emissivity in different wavelength bands. A single-band model additionally provides a simplified approach. If an even higher level of detail is needed, it is possible to use a multiband radiation model.

COMSOL® can either read in vendor-neutral CAD formats or be bidirectionally linked with popular CAD packages, such that any changes to the CAD model will be instantaneously updated in the numerical model. This CAD geometry can be cleaned up using defeaturing tools or simplified for meshing using native functionality. Alternatively, it is also possible to create geometries within the software.

## » COMPUTING THE RESULTS

Once all of this information is assembled and put into a thermal numerical model, the computed results will show the temperature variation over time. For a

very simplified model, this might just be a bulk temperature. For a higher-fidelity model, the spatial temperature variation within all components is computed (Figure 4). This information can be used to check if the satellite will stay within all operational thermal limits. From there, the analyst may want to move on to other types of analyses, such as computing structural deformations that happen due to thermal gradients to see how such deformations alter the optical performance of a telescope. This kind of extensive numerical modeling reduces the need for physical testing and can make satellite engineers confident in their designs prior to launch.

Since the solar, albedo, and Earth infrared irradiation can be considered nearly periodic between orbits, the total irradiation over one orbit can be computed prior to the thermal transient calculation, which typically spans several orbits. This order of operations makes it simpler to test what-if scenarios, such as different combinations of surface emissivities. When iterating through designs, it is possible to use the *Batch Sweep* capabilities on large single computers or the *Cluster Sweep* node capabilities on cluster and cloud computing resources.

Once the design iterations are complete and the satellite is ready for delivery, the COMSOL numerical model can be packaged as a standalone application and given to the satellite operator so that they can test unexpected operating conditions as needed.

## » CONCLUDING REMARKS

Thermal management of satellites is a complex design task, and the operational environment is hard to replicate in physical tests. For instance, there are variables that can only be foreseen with the use of simulation, such as the temperature variations that may occur as satellites travel through orbit or the heat that onboard equipment may generate. With COMSOL Multiphysics, a comprehensive simulation software platform with dedicated functionality for satellite thermal analysis, engineers can quickly iterate and improve designs, verify operational conditions, and share their numerical models with coworkers and customers as simulation applications. ©

*Utrecht University, Netherlands*

# HOW DECAYING SHELLS HELP PRESERVE THE ALKALINITY OF THE SEAS

by ALAN PETRILLO

Calcium carbonates produced by sea creatures help maintain the ocean's alkalinity — and serve as a natural sink for anthropogenic carbon dioxide. To better understand essential but obscure deep-sea biogeochemical processes, Olivier Sulpis of Utrecht University developed an innovative 3D reactive-transport model that shows how certain seashells help preserve calcite grains in seafloor sediments.

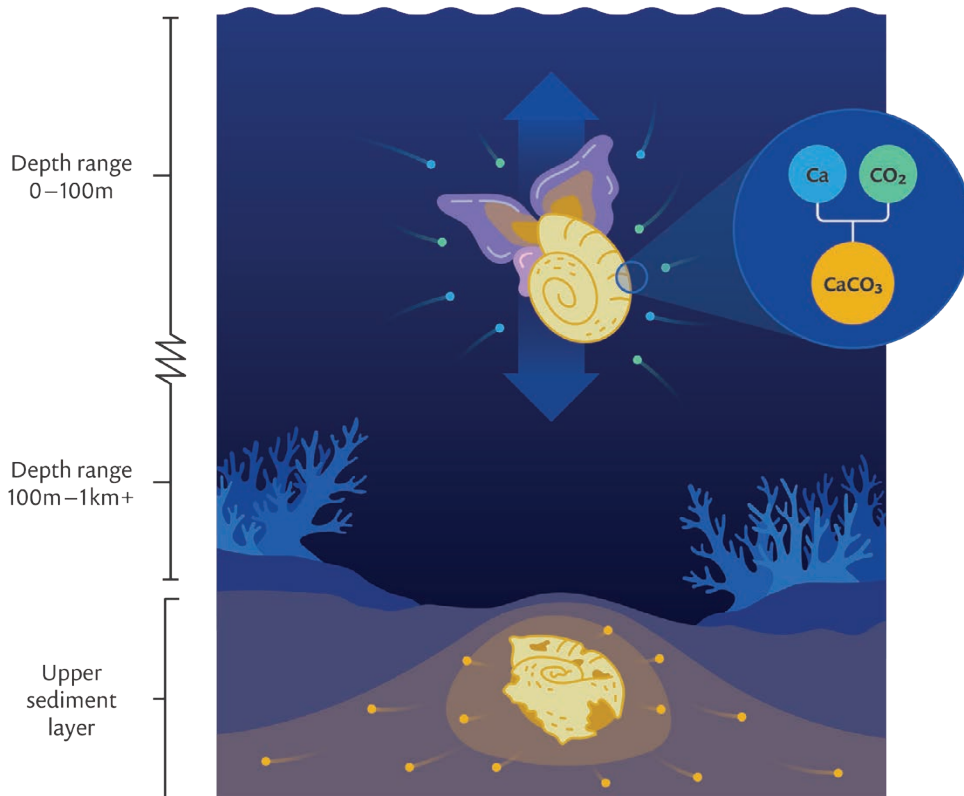

**FIGURE 1** An example of a sea butterfly. Image by NOAA and in the public domain in the United States, via Wikimedia Commons.

Where is the boundary between an organism and its environment? Usually, our eyes seem to be able to answer this question for us. We can visually distinguish trees from the soil, birds from the sky, and seashells from the sea, but appearances can deceive. We may see hard borders between living and nonliving things, but look deeper: The seemingly solid edges of organisms are actually a porous weave that is as beautiful and profound as any tapestry can be.

Organisms become what they are by exchanging matter with their environments, and this cycle reshapes those environments as well. Our eyes and minds may struggle to perceive what is going on at a molecular level, but the impact of life's interplay with the environment can be enormous — perhaps as big as the ocean itself.





**FIGURE 2** After pteropods die, their shells sink to the seafloor, where their CaCO<sub>3</sub> shells decompose. This decomposition helps sustain the alkalinity of the oceans and builds up carbonate-rich sediments over time.

### » THE SMALL BUT SIGNIFICANT SEA BUTTERFLY

Consider, for example, the sea butterfly. "It is like a miniature snail we would see on land, but with wings to fly around in the water," says Olivier Sulpis, a geochemistry researcher at the Netherlands' Utrecht University. Sea butterflies (also called pteropods) are less than 1 cm long, and they produce their thin, translucent shells from aragonite, which is a form of calcium carbonate (CaCO<sub>3</sub>). A different form of calcium carbonate called calcite makes up many other seashells, as well as the exoskeletons formed by corals.

Sea butterflies and their fellow CaCO<sub>3</sub> producers synthesize aragonite and calcite from materials found in seawater. "In seawater, calcium and dissolved carbon are everywhere," says Sulpis. "This makes them ideal ingredients for organisms to use in building crystal structures."

### » EVEN IN DEATH, CaCO<sub>3</sub> PRODUCERS HELP SUSTAIN OCEAN LIFE

Like other carbonate-producing organisms, sea butterflies have an outsized impact on their environment. When pteropods die, the dissolution of their aragonite shells neutralizes some of the CO<sub>2</sub> (which is an acid) that is suspended in seawater. In this way, the world's vast population of sea butterflies helps maintain the alkalinity of the ocean. But rising oceanic CO<sub>2</sub> levels could upset the conditions that enable sea butterflies to produce their shells in the first place. A shrinking population

of aragonite producers could thereby add to a vicious cycle of accelerating acidification.

"We say of sea butterflies that they are 'first responders' of ocean acidification because they are so vulnerable," says Sulpis. Unfortunately, much about them remains a mystery, especially after they die and sink to the deepest parts of the ocean.

### » THE CASE OF THE MISSING ARAGONITE

While calcite is the most common CaCO<sub>3</sub> compound found in the oceans, Sulpis explains that, from his perspective, aragonite — which has a different crystal structure from calcite and is more soluble — deserves more consideration for its role in the oceanic carbonate cycle.

"We do not know a lot about aragonite, but we are able to estimate how prevalent it is in the shallower waters, where the sea butterflies live," Sulpis says. "We can also confirm that their shells sink and reach the deep ocean. When we recover sample cores from deep ocean sediments, there is plenty of calcite, but the aragonite we would expect to find is not there. So where does it go?"

One possible explanation for the "missing" aragonite is that the more soluble aragonite shells dissolve faster than calcite at the seafloor, releasing alkalinity and raising the CaCO<sub>3</sub> saturation of the seawater in the process, thereby protecting calcite from dissolving. If ocean acidification slowed down aragonite shell production and thereby also the "galvanizing" effect of aragonite dissolution, then calcite dissolution would have to make up for more of the CO<sub>2</sub> neutralization at the seafloor than it actually does. But while this theory seems plausible, the challenges of studying the oceanic aragonite cycle make it difficult to prove.

### » GAP IN KNOWLEDGE ABOUT ARAGONITE CYCLING

Explaining how little is known about open-ocean aragonite cycling, Sulpis says, "If you look at published literature, you will find estimates that say aragonite makes up 10% of all the calcium carbonate in the ocean — but you will also find studies that say it makes up 90%!"

Humanity's spotty knowledge of aragonite cycling is rooted in the difficulty of conducting research in the deeper parts of the ocean. Sulpis says, "Observing reactions in seawater at this scale and depth is nearly impossible,

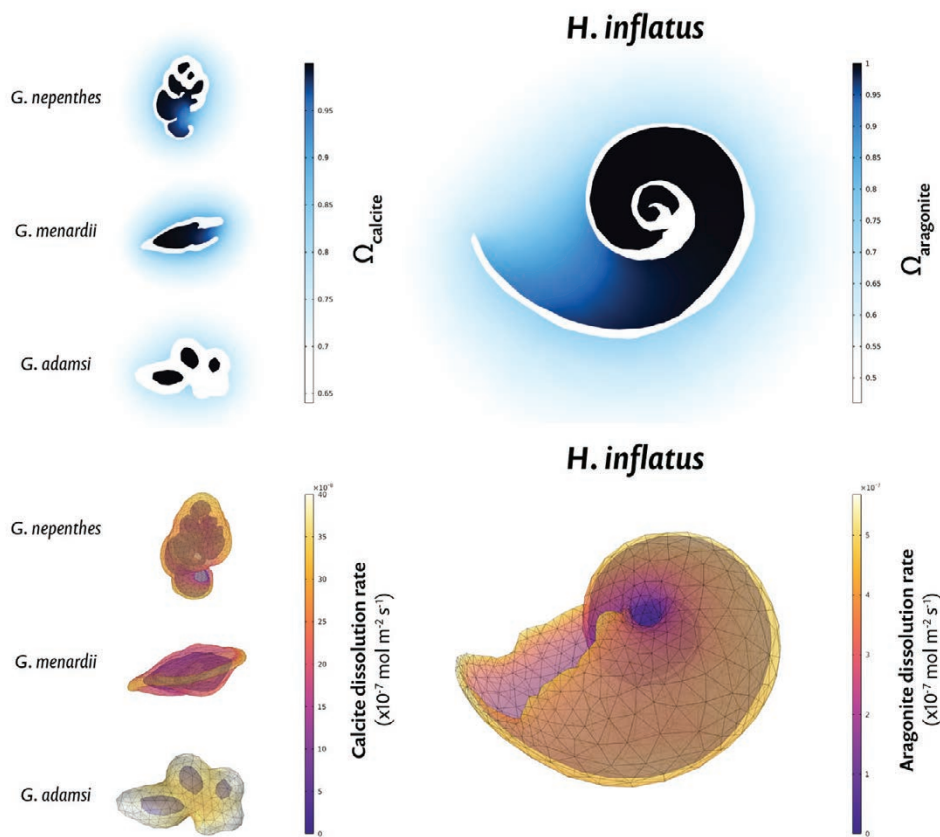

**FIGURE 3** Simulations of the shells of four species, showing changes after being submerged for one minute. The *H. Inflatus* pteropod shell is made from aragonite, while the others are calcite. Models in blue show  $\text{CaCO}_3$  saturation levels in the surrounding seawater (top) and models in the *Heat Camera* color table show the rate at which the shells dissolve (bottom).

as they occur in an environment where we cannot physically go." Physically removing fragile specimens from deep-sea sediment is also challenging. "It is really hard to recover sea butterfly shells with a sediment trap," says Sulpis. "By the time you bring them up from the deep, they will likely already have dissolved. So, there is a lack of good data about calcium carbonate reactions at deep sea pressures and temperatures."

Previous attempts to mathematically model the behavior of calcium carbonate in seawater provide limited value for Sulpis' research. "Most models have treated all  $\text{CaCO}_3$  as calcite, rather than creating separate models

of aragonite. Also, existing diagenetic 'continuum' models do not capture what is happening at the scale of a single grain or a single pore in a seashell," he explains.

Another issue is that older models have rendered  $\text{CaCO}_3$  grains as smooth, uniform objects, which is not accurate. "These grains are complex and heterogeneous micrometer-scale shapes with insides and outsides." Sulpis does acknowledge that some simplifications are necessary, but says, "We wanted to replicate the actual shapes as closely as possible, at the smallest scale possible. Before deciding to simplify some structures, we wanted our

simulation to confirm that these simplifications would not compromise results."

#### » SIMULATED DEEP DIVE INTO THE OCEAN-SEDIMENT BOUNDARY ZONE

For a deeper understanding of how calcite and aragonite interact at the seafloor, Sulpis developed a novel 3D model using the COMSOL Multiphysics® software. This model makes it possible to move virtually among the boundaries between oceanic organisms and their environment. It enables researchers to simulate the dissolution reactions occurring among aragonite and calcite

grains and the seawater that surrounds them. The water's alkalinity, density, and chemical composition were set to match typical deep-sea conditions. The team modeled various solids and simulated their interactions with seawater and seafloor sediment. Sulpis also added seashell models, based on scans of actual specimens, to his sediment-water interface. For example, the *H. inflatus* pteropod shell highlighted in Figure 3 is based on a CT scan of a specimen from the Cariaco Basin off the coast of Venezuela. Such 3D images enabled the simulation to capture how the irregular shape of a shell could affect its dissolution.

The simulation indicates that the inner shape of a shell may not have a significant impact on how it reacts with seawater. "If you look at the top row, it tells us that inside these shells, the trapped water can become completely saturated with  $\text{CaCO}_3$ . This prevents further dissolution from occurring along the complex inner surface, and so the shells dissolve from the outside in," Sulpis says. These results suggest that some simplification of a shell's modeled shape will not necessarily affect simulation results, at least when the shell is completely surrounded by seawater.

Now, what happens when a pteropod shell and seawater are added to calcite-rich sediment? Figure 4 presents the simulated effects of this interaction. A dissolving sea butterfly shell is shown to prevent the dissolution of calcite grains mixed into the sediment. These grains were rendered as spheres — a simplification that Sulpis made based on the results of simulations such as those in Figure 3.



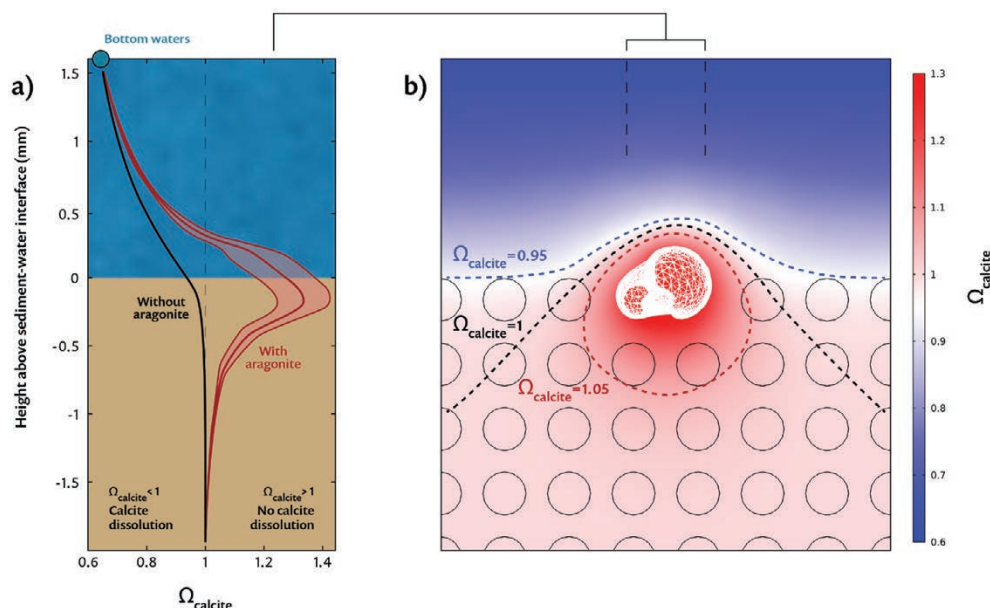

**FIGURE 4** The tendency for calcite dissolution above, at, and below the sediment–water interface (a). A dissolving pteropod shell affects the boundary zone around the sediment–water interface (b).

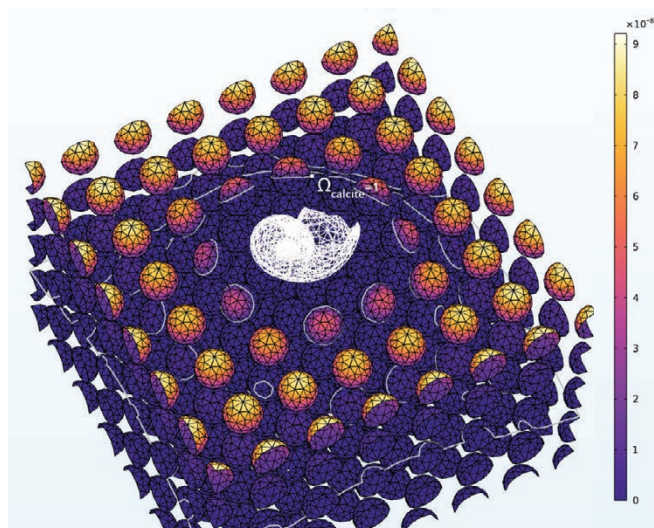

**FIGURE 5** Simulation results showing how the presence of a pteropod in the seafloor sediment affects the dissolution rates of nearby calcite grains. Lighter-colored areas indicate where dissolution is occurring more rapidly. The white lines indicate the saturation line, or isocontour, where calcite is at equilibrium with its dissolution byproducts, meaning there should not be any net dissolution or precipitation.

The seawater that mingles with solids near the sediment–water interface plays a crucial role in this process. The boundary between the seafloor and the water is varied, and seawater circulates around solids, even below the apparent line of separation. Capturing the graded boundary between

seawater and sediment is one of the advantages of Sulpis' 3D model. As the pteropod shell dissolves, the surrounding seawater becomes saturated with aragonite. This zone of saturated seawater mixed with sediment is indicated by the red shading in Figure 4b. It is this aragonite-saturated seawater that chemically interacts with — and protects — the calcite left behind by other organisms.

Figure 4a shows the seawater saturation state with respect to calcite, which is its ability to be dissolved throughout this transition zone between sea and sediment. At 1.5 mm above the seafloor, seawater is undersaturated, and any calcite grains should dissolve quite readily. The black line shows that in the absence of any aragonite source, calcite dissolution should continue at the sediment–water interface. The red line indicates the zone where pteropod shell dissolution should arrest the

dissolution of suspended calcite grains, because of the supersaturation it generates.

## » HELPING OTHER HUMANS MEND THE SEAS

Having developed a new means of analyzing underwater micrometer-scale biochemical processes, Sulpis is now exploring how his work can guide further research. "Our next step has been to try to replicate these processes in the lab, with calcite and pteropod shells in beakers. So far, experimental results are similar to what the simulation shows," he says.

"The goal now is to use this information to better interpret what we can observe in situ." Toward this end, Sulpis and his colleagues have obtained a grant from the Dutch Research Council (NWO) to directly study how aragonite producers shape their environment.

Of course, the organism whose activity has the greatest impact on its environment is the human. Anthropogenic acidification threatens the life-sustaining tapestry that ocean creatures weave among their parts of Earth. With this in mind, the broader project of understanding carbonate cycles takes on added urgency. "Compared to how much  $\text{CO}_2$  we are adding to the oceans, only a tiny amount is being neutralized," says Sulpis. "Maybe the carbonate cycle process can do the job, but it may take several thousand years to do so!"

Taking a more immediate perspective, Sulpis is eager for fellow humans to apply his research and analysis to protecting the sea butterflies' world — and ours. "Our models are all open access," he says, "and I hope others can make use of what we have created." ☺

*Zeugin Bauberatungen, Switzerland*

# HARMONIZING SOUND AND STYLE IN OPEN-PLAN OFFICES

Workplace conversations and calls are generally a distraction in open-plan offices. To improve the acoustical conditions of a workplace, Swiss consultancy Zeugin Bauberatungen models how sound propagates through office building designs and analyzes specific design modifications to find the right fit.

by ALAN PETRILLO

Acoustical engineers, like composers, can help shape the effect that sound has on human ears. And while the sounds that surround everyday life may not be as moving as a symphony, the acoustics of a room can have a profound impact on the people inside. Many modern offices are open-plan designs, meaning there is minimal physical separation between workspaces. Silencing every open-office conversation is neither possible nor necessary, but attention to workplace acoustical conditions can make other people's conversations less distracting.

To help fine-tune the composition of workday soundscapes, Swiss consultancy Zeugin Bauberatungen uses the COMSOL Multiphysics® software to predict how sound will propagate through a proposed room design. Zeugin's precise models of acoustical effects enable the team to suggest practical improvements that are pleasing to the ear as well as the eye.

"Large sound-absorbing barriers may contradict the

**"Our simulations help us propose optimization methods that harmonize with the architects' vision, along with improving employees' acoustical work environment."**

— THOMAS ZEUGIN, FOUNDER AND MANAGING DIRECTOR OF ZEUGIN

interior design concept by visually cluttering the space," said Thomas Zeugin, founder and managing director of Zeugin. "Our simulations help us propose optimization methods that harmonize with the architects' vision, along with improving employees' acoustical work environment."

## » SIMULATION-GUIDED DESIGN TO MAKE SPEECH LESS DISTRACTING

Thoughtful interior design decisions can significantly improve the sound quality of a room. When optimizing workplace acoustics, improving sound quality actually involves making speech *less* intelligible. A muffled murmur of voices is simply less distracting than a clear, crisp conversation among other people.

The sound waves of comprehensible human speech occupy a particular set of frequencies. Zeugin produced a case study on building acoustics that explains that the fundamental frequency of voices during a conversation typically ranges between 100 Hz and 250 Hz. When we form words, certain movements of our throats and mouths cause changes in frequency; for example, consonants have their own frequency range of 250 Hz–8 kHz. Modifying sound waves in these ranges can help make speech less intelligible — and thereby less distracting.

The table in Figure 2 presents three indicators related to speech intelligibility, along with ranges that correspond (from left to right) with better overall acoustic conditions. The Zeugin team constructs models of possible room designs using the COMSOL® software, which enables them to predict values for these and other relevant metrics.



» CALCULATING SOUND PATHS AND INSULATION VALUES

Considering his professional role of orchestrating aural effects, it is no surprise that Thomas Zeugin is also a trained musician. "I completed a music degree in guitar at the Swiss Jazz School in Bern before founding an engineering consultancy with my father," he explains. "Due to my musical education, I have been strongly interested in acoustic and sound optimization of rooms and buildings from the very beginning."

Of course, Thomas' analyses are based on much more than his well-tuned hearing. "The first step is a rough statistical calculation, based on Eyring's reverberation time equation, for the room that is being examined. After we receive more detailed architectural plans of interior design, we can construct a 3D model in COMSOL," he said.

"Once we have a model of the room, we can perform calculations using ray acoustics to obtain those important room acoustics metrics. We also use the *Acoustic Diffusion Equation* interface in the add-on Acoustics Module," continues Thomas. "This enables us to calculate secondary sound path transmissions and the sound insulation values of room partitioning components. We can then

simulate how those factors influence acoustic conditions across the modeled space."

» COMPARING THE EFFECTS OF SOUND MITIGATION MEASURES

The case study mentioned previously provides instructive examples of how Zeugin uses simulation to address real-world design problems. This particular project, which focused on an office building in the Swiss city of Ostermundigen, included analysis of sound propagation in a large open room. The initial design of the space (Figure 3) featured multiple shared work tables, a wide wall of windows, a double-layer floor, and a concrete ceiling with suspended acoustical panels. Other materials and furnishings had yet to be selected.

"Our simulation shows that if no sound mitigation measures are taken, the low-frequency sound waves generated by speech can spread unhindered throughout the room," Thomas said. "We can derive a deflection distance value from our simulation, and it shows that distracting levels of speech can spread as far as 12 meters from the source." These and other metrics decisively place this room's acoustics in the poor to moderate categories, as defined in Figure 2.

Fortunately, this performance can be improved through strategic placement of architectural elements. Figure 4 shows the impact of two specific design changes: the installation of sound-absorbing curtains over the windows and the placement of two suspended foam panels with an inserted sheet of steel near the center of the room.

The curtains bring the entire room into Zeugin's

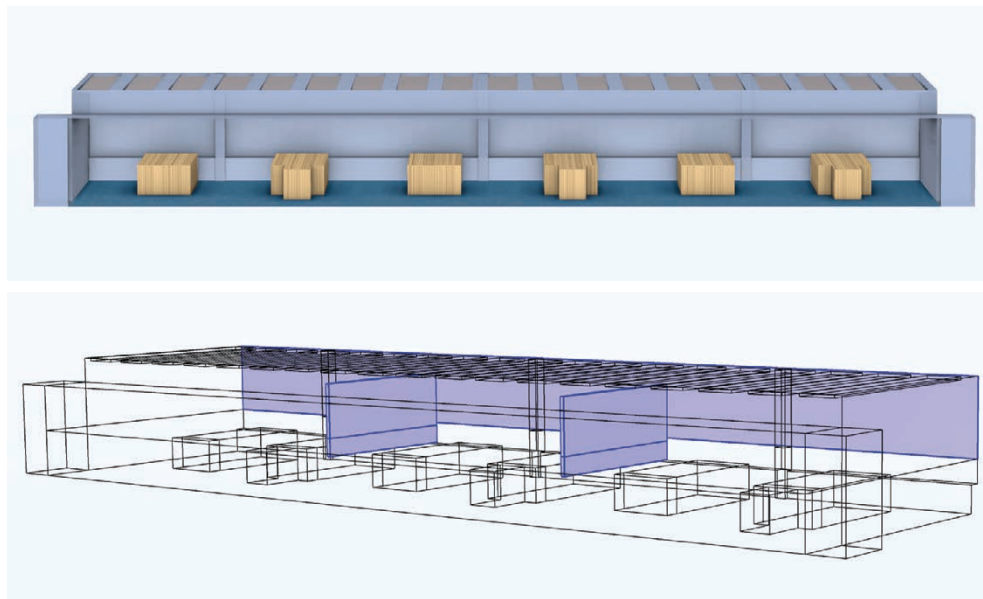

**FIGURE 1** An open-office design that was modeled by Zeugin Bauberatungen using the COMSOL Multiphysics® software. The modeled space includes a series of workstations (shown in tan at top) in a large carpeted room with a suspended ceiling and windows along the entire back wall. Sound-absorbing panels and curtains (shown at bottom) reduce the noise level and improve acoustical working conditions.

	Poor Acoustic Conditions	Moderate Acoustic Conditions	Good Acoustic Conditions
Deflection Distance $r_D$	$r_D > 10$ m	$10 \geq r_D > 5$ m	$r_D \leq 5$ m
Spatial Decay Rate $D_{2,5}$	$D_{2,5} < 5$ dB	$5 \text{ dB} \leq D_{2,5} < 7$ dB	$D_{2,5} \geq 7$ dB
A-Weighted Sound Pressure Level of Speech at 4 m $L_{P,A,S,4m}$	$L_{P,A,S,4m} > 50$ dB(A)	$50 \geq L_{P,A,S,4m} > 48$ dB(A)	$L_{P,A,S,4m} \leq 48$ dB(A)

**FIGURE 2** A table presenting poor, moderate, and good ranges of acoustical performance according to the three metrics listed in the left-hand column. Source: EN ISO 3382-3:2012.

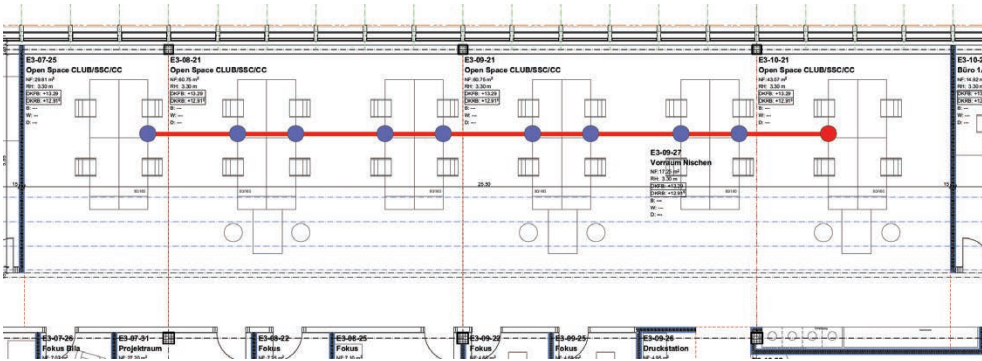

than cubicle walls around individual desks. Such dividers may provide workers with a visual sense of privacy, but acoustically, "Walls between the workstations only reduce sound levels by 2–3 dB," Thomas said. By providing data-driven analyses to counteract popular misconceptions about sound, simulation can help guide Zeugin's clients toward more acoustically effective interior designs.

» COMPOSING INDOOR AND OUTDOOR SOUNDSCAPES WITH SIMULATION

Just as a composer's work should resonate with audiences of any size, the value of the Zeugin team's acoustical analyses extends far beyond the individual office worker's ears. For example, the team is currently working on a redesign of a company's dining halls and conference rooms, which host gatherings that place high demands on acoustics both within and between rooms. Other projects call for noise abatement on an even grander scale. In the city of Bern, Zeugin has been engaged to improve the acoustics of an entire neighborhood that is located next to a busy highway.

"Due to the functionality and flexibility of the COMSOL software, we can construct models and perform comparable calculations for many different types of projects," said Thomas. "Based on our follow-up measurements, we've found that our simulated results closely match real-world conditions. This gives us confidence in our findings and reassures our customers as well." ©

**FIGURE 3** An overhead view of the office design modeled by Zeugin. The red dot indicates the source of simulated sound waves, and the blue dots indicate measurement points.

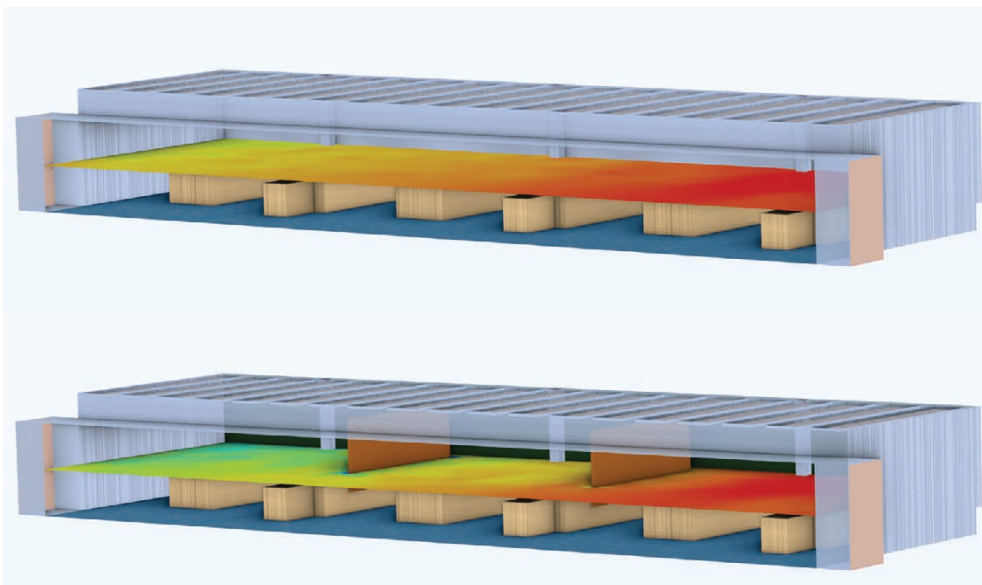

**FIGURE 4** Images from Zeugin's model showing the volume distribution of 1000-Hz sound waves in the office with no mitigation measures present (top) and the distribution of 1000-Hz sound waves with suspended panels and acoustical curtains installed (bottom).



**FIGURE 5** A close-up of the leftmost suspended panel and how it affects the volume distribution.

"moderate" range, and the hanging panels significantly expand the area encompassed by "good" acoustical working conditions. "Absorbent materials can help," said Thomas, "but we see the largest benefit from placing high-mounted barriers that directly interrupt the paths of sound waves." Note that the beneficial barriers he describes are large panels near the center of the room, rather



COMSOL, Sweden

SHIFTING TO 3D

# Motor Modeling Gears Up for Vehicle Electrification

by DURK DE VRIES

Electric motors and drive systems have existed for almost 200 years, and so have electric vehicles. Today, there are many different motor designs available, targeting different markets. Some motors are developed to be inexpensive, some to be efficient, and others powerful. However, never before has there been such a strong incentive to combine all three criteria in one design. The search for clean energy solutions has created a sense of urgency; with a new generation of electric vehicles on the rise and many billions of dollars being poured into electric drivetrain development — by both industry and government stakeholders — there is a strong need for advanced numerical analysis.

Furthermore, there is no single winning design. There are at least a handful of motor types that could claim the throne, and their requirements differ depending on the particular application, whether it is the transport of goods, public traffic, or motor sports, for example. To push the envelope even further, some companies have combined different motor types, like Koenigsegg Automotive AB did recently with its "radial flux" motor. Finally, the aerospace and marine industries are pushing for electric solutions as well. All in all, there is a vast landscape of options to explore for achieving the best motor design, and 3D motor modeling will be paramount to its success.

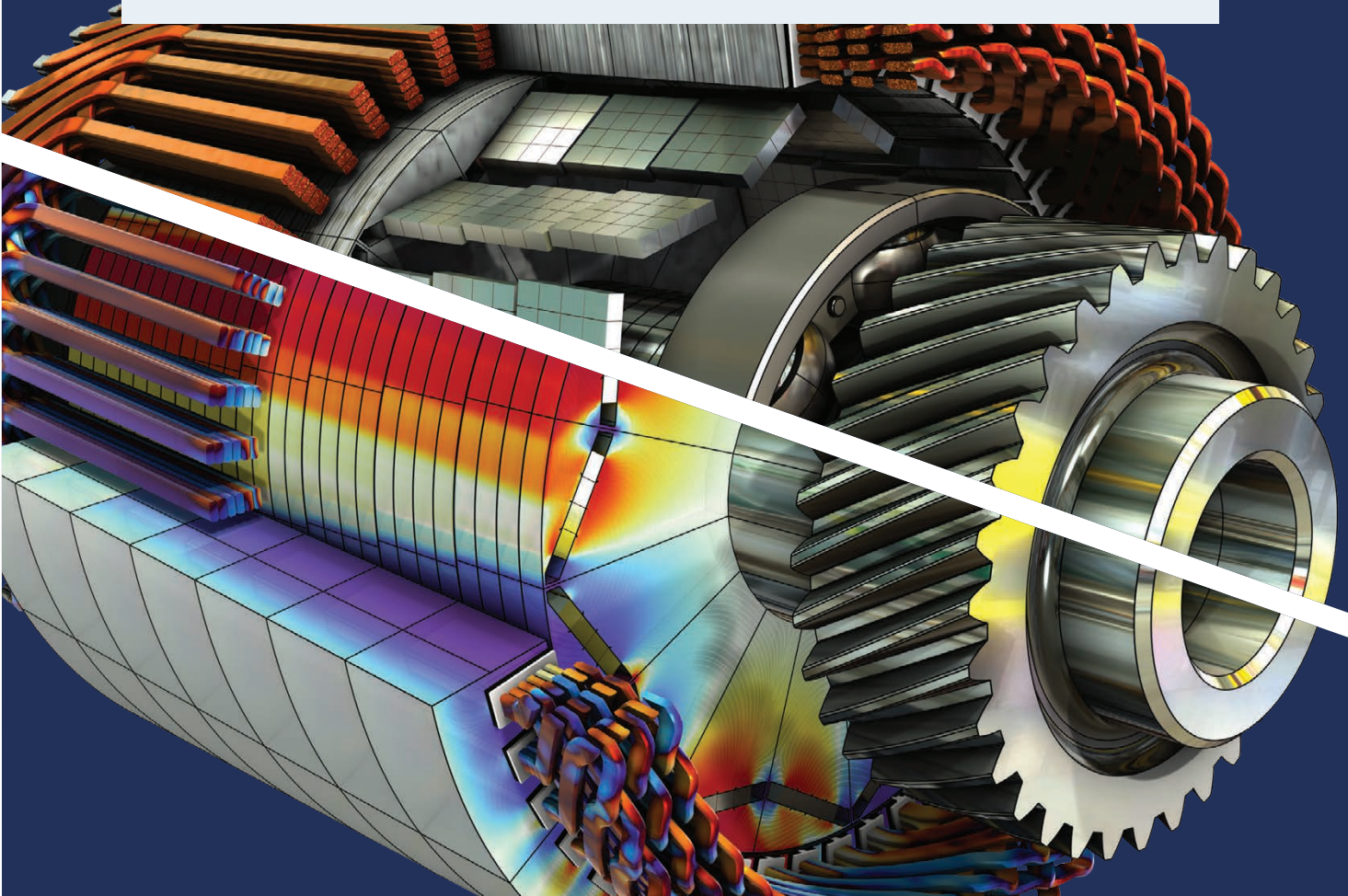

## COMPARING 3D MOTOR DESIGNS

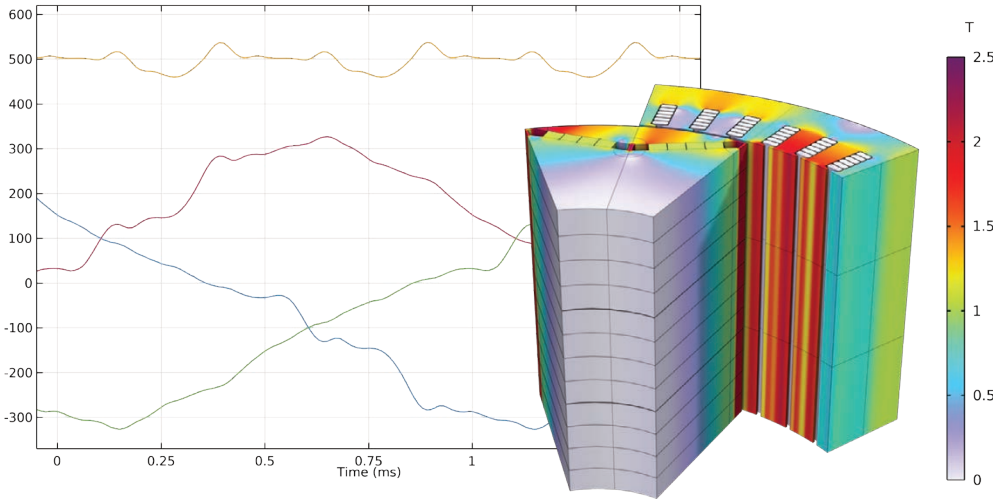

### EXTRUDED 2D

Relatively simple 3D model. Minimal hardware requirements. Very close agreement with 2D models. Helps investigate and validate the basics of 3D modeling.

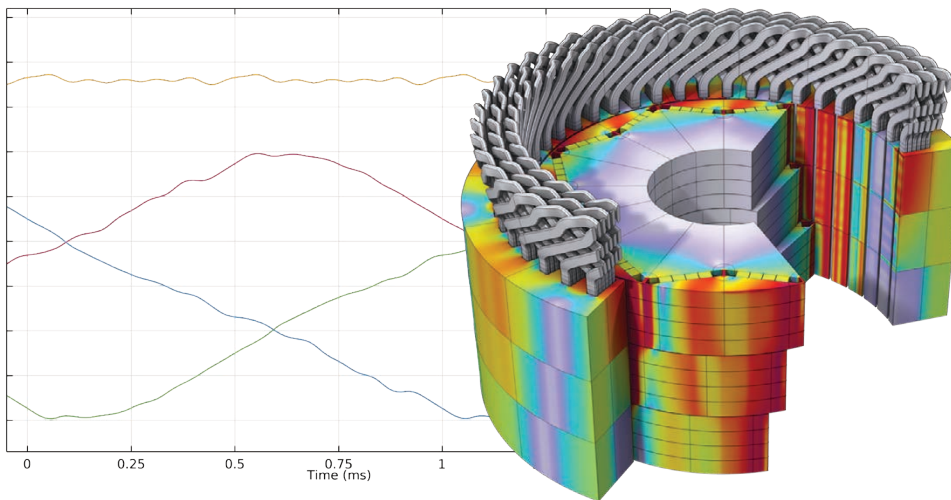

### SYMMETRIC 3D

Assumes symmetry at the axis midpoint. (Front and back are solved sequentially.) Moderate hardware requirements. Effective method for investigating the end effects and several skew configurations.

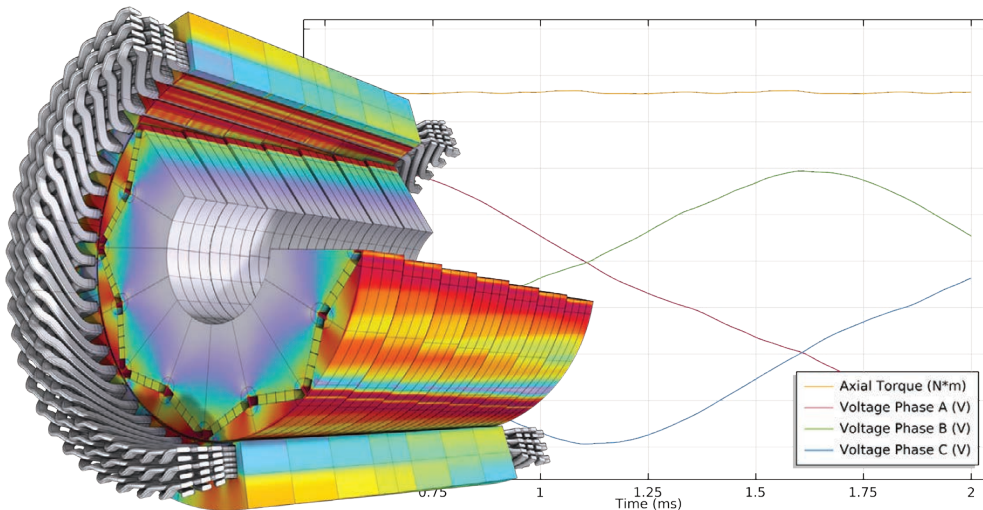

### FULL-LENGTH 3D

Assumes sector symmetry only. Moderate to substantial hardware requirements. More suitable for complicated skew designs (combined rotor-stator skew) and fully coupled multiphysics phenomena that may break the symmetry. Supports a wide range of configurations to calibrate 2D models.



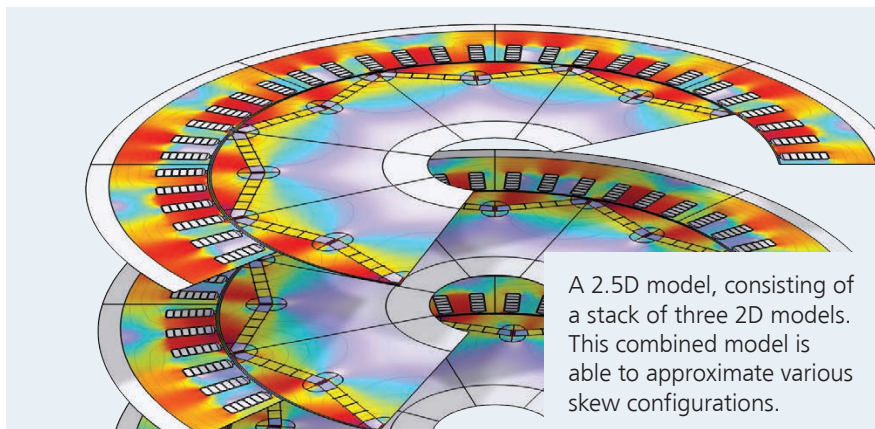

## CALIBRATING 2D MOTOR MODELS

Once tested and conditioned properly, 2D and 2.5D motor models can be very useful indeed, especially within the context of topology optimization or parameter sweeping. Many 3D effects can be replicated or approximated with 2D models. This can be done for radial flux machines and, to some extent, axial flux machines too.

2D models have a number of blind spots, though. Traditionally, they have had to be calibrated and verified using very costly prototype development cycles. Well-established manufacturers have typically relied on data they have gathered over many years, sticking to familiar designs. Now, with recent advancements in hardware and software development, 3D motor models can close the gap, enabling considerable cost reduction and faster product development.

An important preliminary step is to develop trust in 3D models. This can be done by looking at simple cases for which the 2D solution is known to be exact — like a 3D model that is no more than a simple extrusion. These configurations can be used to tune the 3D meshes and solver settings to find a good compromise between solving speed and accuracy. Comparing with measurements is an option too.

From this point onward, the 3D model can take many forms — with or without skew, with or without end turns, with or without magnet segmentation cuts, and so on — and a comparison between these forms can be

used to isolate certain effects. The next step is to determine to what degree they can be replicated in 2D and, if they cannot be, if there is some underlying logic that can be used to augment the 2D models to better reproduce the 3D results — and ultimately, the measurements.

When doing so, the 3D models will be very useful to map the key points of interest: Even if we do not know precisely which materials are going to be used or which thermal conditions are going to apply, we can still investigate which input parameters have a strong influence on the performance of the machine and which can be ignored — or can be used to save costs.

Finally, it is important to keep in mind that the electric motor is a multiphysics machine. Therefore, an optimal design will take into account mechanical, acoustical, and thermal performance as well.

## 2D VS. 3D MOTOR MODELING

Historically, 2D motor modeling has been dominant because it has provided sufficient accuracy for very little computational effort. However, in recent years, the demand to fully resolve 3D phenomena has increased. Together with enhanced motor modeling software and increasingly powerful hardware, this demand opens up a whole new market.

Full-fidelity 3D modeling provides valuable insight into many effects that otherwise are difficult to reliably quantify. Some of these can be replicated in 2D, some can be approximated, and some

can be compensated for. Using the COMSOL Multiphysics® software, we have investigated a number of these effects, including:

- Fringing effects
- Torque ripple reduction by means of rotor skew, stator skew, or the application of grooves
- Flux leakage between step-skewed rotor segments
- Eddy currents in the magnets and the effect of magnet segmentation cuts for suppressing them
- Resistive effects, inductive effects, and loss in the end turns
- Skin and proximity effects inside and between the turns
- Electric field singularities increasing the risk of electromagnetic breakdown

In addition, there are several multiphysics effects to consider, such as those related to heat transfer, structural mechanics, acoustics, and fluid dynamics.

A move toward 3D motor modeling seems inevitable but should not be seen as a solution on its own. In practice, the best development strategy involves a combination of 2D modeling, 3D modeling, and prototyping. Computationally demanding research such as topology optimization studies will typically still be done using heavily fine-tuned 2D models before going back to 3D. In this context, the 3D models serve as the missing link between the 2D models and the prototypes: they allow designers to gain a more profound understanding of the machine, help them to better interpret the measurements and calibrate the 2D models, and — most importantly — aid in making better design choices.

## 3D MOTOR MODELING RESOURCES

The COMSOL Multiphysics motor modeling capabilities have been extended in recent years, resulting in better performance and usability, and better example models. For free access to a collection of detailed resources on 3D motor modeling, visit:

[www.comsol.com/model/110261](http://www.comsol.com/model/110261). ©

# COMSOL Learning Center

[comsol.com/support/learning-center](https://comsol.com/support/learning-center)

The Learning Center is a collection of on-demand modeling and simulation learning materials. All of the resources are free and open access for users of all skill levels. The content offers a structured learning experience in the form of articles, tutorial videos, model files, modeling exercises, and step-by-step instructions.

Access multipart and standalone resources across topic areas:

- Electromagnetics
- Structural Mechanics
- Acoustics
- Fluid Flow
- Heat Transfer
- Chemical Engineering
- Modeling Workflow
- Interfacing
- Equation-Based Modeling
- Optimization
- Simulation Apps

## SUGGESTED RESOURCE

### Getting Started with COMSOL Multiphysics®

This multipart resource covers the fundamentals of using the COMSOL® software. Exercise files and resources are included to help users gradually build essential skills and feature both step-by-step and more open-ended examples. Get familiar with the modeling workflow, efficient modeling and simulation techniques, and how to build a simulation application based on a model.



The screenshot displays the COMSOL Learning Center interface. At the top, there is a navigation bar with links for PRODUCTS, VIDEOS, EVENTS, BLOG, LEARNING CENTER, and SUPPORT. The main content area is titled 'Learning Center' and features a course titled 'How to Navigate the COMSOL Multiphysics® User Interface'. Below this, a specific article is highlighted: 'How to Select Geometry'. The article text explains that there are many points during the model building process where selections of geometry are needed. It lists 'Basic Geometry Selections' which include using the mouse, the Graphics window toolbar, the Selection List window, and the Settings window. A video player is embedded in the article, showing a 3D model of a cube with a selection box. To the right of the article is a 'Course Parts' sidebar with a list of related resources, including 'Introduction to the COMSOL Desktop', 'Using the Graphics Window', 'How to Select Geometry', 'Basic Geometry Selections', 'Personalize the COMSOL Desktop', 'Searching Models, Data, and Auto-completing Expressions', 'Learning to Use General-Purpose, Time-Saving Features', 'Utilizing Keyboard Shortcuts', and 'Accessing Help Resources Within COMSOL Multiphysics®'.