

WARNING

Information subject to the export control laws. This document, which includes any attachments and exhibits hereto, contains information subject to International Traffic in Arms Regulation (ITAR) or Export Administration Regulation (EAR) of 1979, which may not be exported, released or disclosed to foreign nationals inside or outside the U.S. without first obtaining an export license. Violators of ITAR or EAR may be subject to a penalty of 10 years imprisonment and a fine of \$1,000,000 under 22 U.S.C. 2778 or Section 2410 of the Export Administration Act of 1979. Include this notice with any reproduced portion of this document.

COPYRIGHT NOTICE

©1996-1998 AlliedSignal, Inc.

Reproduction of this publication or any portion thereof by any means without the express written permission of AlliedSignal Electronic and Avionics Systems is prohibited. For further information contact the Manager, Technical Publications; AlliedSignal Electronic and Avionics Systems; One Technology Center; 23500 West 105th Street; Olathe, Kansas 66061. Telephone: (913) 782-0400.

RDR 2000 OPERATIONAL CONTROLS	.1
TEST PATTERN	.4
FAULT ANNUNCIATIONS	.4
PREFLIGHT	.5
PREFLIGHT WARNINGS	.5
THEORY OF OPERATION	.7
GENERAL	.7
RADAR PRINCIPLES	.7
WEATHER RADAR PRINCIPLES	.8
RADAR BEAM ILLUMINATION	.8
RADAR TILT ANGLE CALCULATOR USER INSTRUCTIONS	.10
RADAR REFLECTIVITY	.13
WEATHER DISPLAY CALIBRATION	.14
WEATHER ATTENUATION COMPENSATION	.15
TARGET ALERT	.17
ALTITUDE RING (RANGE RING)	.18
RADOMES	.18
WEATHER MAPPING AND INTERPRETATION	.20
OBSERVING WEATHER	.20
THUNDERSTORMS & TURBULENCE	.21
TORNADOES	.21
HAIL	.22
ICING	.23
SNOW	.23
LIGHTNING AND STATIC DISCHARGES	.24
GROUND MAPPING AND INTERPRETATION	.25
LOOKING ANGLE	.26
OPERATION IN-FLIGHT	.27
GENERAL	.27
TILT MANAGEMENT	.27
EARLY DETECTION OF ENROUTE WEATHER	.29
SEPARATION OF WEATHER AND GROUND TARGETS	.29
SHADOWED AREAS	.32

Table of Contents

TARGET RESOLUTION	32
RANGE RESOLUTION	32
AZIMUTH RESOLUTION	33
PATH PLANNING	33
PATH PLANNING CONSIDERATIONS	34
ANTENNA STABILIZATION	36
CRITERIA	36
PITCH ERRORS	36
TURN ERRORS	36
EFFECT ON RADAR STABILIZATION	37
DURING TAKEOFF	38
SHALLOW-BANKED TURNS	38
STABILIZATION LIMITS	38
STABILIZATION FLIGHT TEST CHECKLIST	40
VERTICAL PROFILE (VP) THEORY OF OPERATION	42
VP OPERATION IN-FLIGHT	42
VERTICAL PROFILE	42
OPERATION	43
WEATHER RADAR INTERFERENCE	52
OPTIONS	55
CHECKLIST	55
MOVING-MAP NAVIGATION	56
SPECIFICATIONS	57
RDR 2000 SENSOR (ANTENNA, RECEIVER, TRANSMITTER)	57
INDICATOR IN-182A	58
APPENDIX:	59
LICENSE REQUIREMENTS	59
SAFETY INFORMATION	62

RDR 2000 OPERATIONAL CONTROLS



BRT - Controls brightness of the indicator display (CW rotation for max brightness).

Wx/WxA - Alternately selects between the Wx (weather) and WxA (weather-alert) modes of operation. "Wx" or "WxA" will appear in the lower left of the display. Wx or WxA colors are: Black for no returns, Green for weak returns, Yellow for moderate returns, Red for heavy returns and Magenta for intense returns. When the WxA mode is selected, magenta areas of storms flash between magenta and black at a 1 HZ rate.



VP - Selects and deselects the Vertical Profile mode of operation. When VP is selected on the indicator the radar will provide a vertical scan of ± 30 degrees at the location of the horizontal track line. Selecting the VP mode of operation will not change the selected mode of operation: TST, Wx, WxA or GND MAP. Once in VP, these modes may be changed as desired. VP will engage from the NAV MAP mode, but NAV data will not be displayed during VP operation.



NAV MAP - Places indicator in navigation mode so that preprogrammed waypoints may be displayed. If other modes are also selected, the NAV display will be superimposed on them. This button is effective only if an optional radar graphics unit and Flight Management System is installed. If activated without these units, NO NAV will appear at lower left of screen. The radar will display weather when NAV MAP is selected if the radar selector is in the ON position.



GND MAP - Places the radar system in ground mapping mode. Gain control capability is configurable at installation to be enabled or disabled in ground map mode. Ground map colors are: green for weak returns, yellow for moderate returns and magenta for intense returns. "MAP" will appear on the lower left of the display.

Operational Controls



GAIN - The gain knob adjusts the radar gain from 0 to -20 dB (CCW rotation reduces gain). The gain knob will only function when in the MAP mode.

LOG - Used when Bendix/King radar graphics units are installed. A listing of the latitudes and longitudes of selected waypoints are displayed. When a compatible navigation source is installed, the selected VOR frequencies along with bearings and distances are also displayed. The radar transmits in the LOG mode, unless a Bendix/King radar graphics unit (IU-2023, GC-360A or GC-381A) is installed.



ON - Selects the normal condition of operation for weather detection and/or other modes of operation. The system will transmit after a 60 second warm-up time is completed. The radar system initializes to the Wx mode, 80 nm.

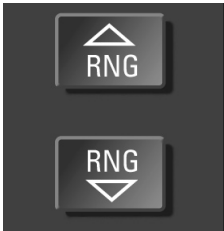
Note: The 60 second warm up period can be monitored upon power up of the system. When the knob is switched directly from OFF to ON mode (or LOG mode with no Bendix/King radar graphics unit installed), the display will blank. As the radar sweeps the blue/white will grow outward. Just before the warm up period is complete, the screen will turn black for a few seconds, then the radar will begin transmitting and the screen will display radar returns. No radar transmissions occur until the warm up period is complete.

TST - The multicolored arc display test pattern is displayed in this mode of operation. The test pattern (typical 4-color test pattern on page 4) is initialized and sized to fit the 80 nm range and can also be scaled with the range select buttons. No radar transmissions occur while TST is selected. TEST will appear in the lower left of the display. STAB OFF is always displayed in top left.

SBY - Fully energizes the system circuitry but no radar transmissions occur in the SBY mode of operation. The antenna is parked at 0 degrees azimuth and 30 degrees tilt down with the antenna drive motors locked. In the standby mode of operation, NAV MAP, checklist and TCAS traffic can be activated with a Bendix/King radar graphics unit (IU-2023B, GC-360A, GC-362A or GC-381A) installed. SBY will appear in the lower left of the display.

OFF - Removes primary power from the radar indicator, but the radar still has power applied. The radar will remain active with no radar transmissions occurring, for up to a maximum time of 30 seconds. This time delay allows time to park the antenna at 0 degrees azimuth and 30 degrees tilt down.

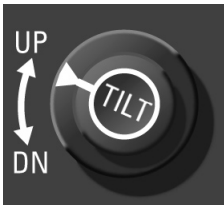
Note: *The only way to remove primary power from the radar is to pull the radar circuit breaker.*



RNG - Clears the display and advances the indicator to the next range. The upper button increases range, the lower button decreases it. The RDR 2000 display ranges are: 10, 20, 40, 80, 160, 240 nm. The selected range is displayed in the upper right corner of the display with the range ring distance displayed along the right edge.

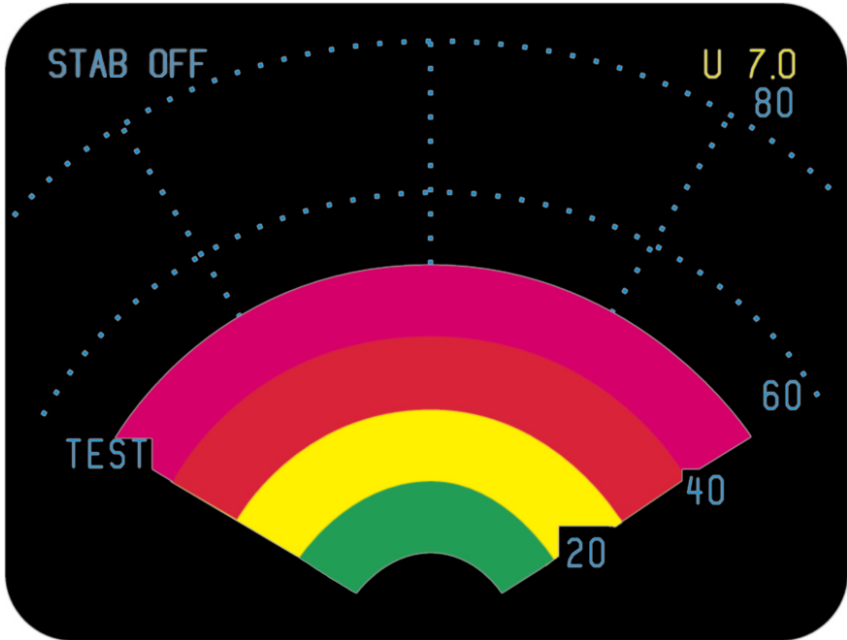


TRK - Provides a yellow track centerline for vertical profile. With the radar on and a track button pushed, the track line position moves left or right in 1 degree increments at a rate of about 15 degrees per second. When Vertical Profile mode is selected, the antenna scans the slice at the track line azimuth position. While in Vertical Profile mode, the TRK buttons move the slice left and right. The azimuth position of the antenna is displayed on the upper left corner of the indicator.



TILT - Permits manual adjustment of antenna tilt 15° up or down for best indicator presentation. The tilt angle is displayed in the upper right corner of the display.

TEST PATTERN



FAULT ANNUNCIATIONS

Fault annunciations are a method of alerting the pilot that the radar system is not performing to established standards. Built-in test equipment (BITE) automatically and constantly tests the radar system. If a fault occurs, the fault annunciation will be presented on the Display unit. There are two general categories of faults: hard failures and soft failure/annunciations. By careful observation of the Display, you can quickly evaluate the condition of the ART 2000.

Hard failures are those which occur when a major function of the system is lost. Hard failures are typically a total loss of transmitter power, receiver gain or no antenna scan. Turn off system. Should the system be left on, further damage to other system components could occur.

Hard Failures:

Annunciation

TX FLT
429 FLT
ANT FLT
IN FLT 6

Failure

Transmitter failure
Loss of 429 bus data
Loss of antenna position
Loss of communication between display and ART

Note: A TX FLT is indicated if the Strut switch is configured to be active and the aircraft is on the ground.

Soft failures are those which can cause limited system operation, Radar data will still be displayed but the flight crew should be aware that the display does not necessarily represent the true weather. Soft failures are typically configuration problem, stabilization problems, or some similar problem.

Soft Failures:

Annunciation

TX FLT alternating with ANT FLT

STAB LMT

STAB OFF

Cause

Configuration module not being read

Stab. Is exceeding $\pm 30^\circ$

Alert that the scan is not being stabilized

PREFLIGHT

PREFLIGHT WARNINGS

Do not turn the radar on within 5 feet of containers of flammable or explosive material. The radar should never be operated during fueling.

Do not attempt to operate the radar until you are completely familiar with all safety information, including that on pages 58 through 61.

The system always transmits in the ON mode, unless the aircraft is on the ground and the radar is interfaced to the strut switch. The radar transmits in LOG mode if the radar is not interfaced to a Bendix/King radar graphics unit. The system never transmits in the OFF, SBY or TST modes.

Accomplish the following procedures completely and exactly.

1) Place the radar controls in the following positions:

- Function switch to TST
- Tilt to UP 7 (as shown on the indicator display, upper right corner).

The test pattern will appear. See that the test pattern conforms to the illustration (The test pattern is sized to fit the 80 nm range and can be scaled with the range buttons), and observe the “update” action as a small ripple moves across the display along the outer edge.

Preflight

- 2) With the function switch in TST or SBY, taxi to a clear area where there are no people, aircraft, vehicles, or metallic buildings within approximately 100 yards.
- 3) Rotate the function switch to ON. The indicator will automatically display in the Wx mode and 80 nm range. Any targets (weather or ground) will be displayed in green, yellow, red, or magenta. (Note: A 60 second warm up time period is required before the system will transmit).
- 4) Press the range-down button to display 40 nm as the maximum range.
- 5) Press the WxA button and observe that magenta areas (if any) flash.
- 6) Vary the tilt control manually between 0 and up 15 degrees and observe that close-in “ground clutter” appears at lower settings and that any local rain appears at higher settings.
- 7) Repeat the manual tilt adjustment, this time between the 0 and down 15 degrees positions.
- 8) Return the function switch to TST or SBY before taxiing!
- 9) When you are ready for weather detection (after takeoff or just before), place the function switch to ON and operate the system as described in the [Operation In-Flight section](#).

THEORY OF OPERATION

GENERAL

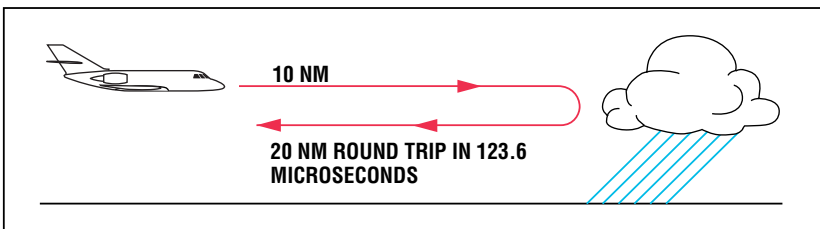
The primary use of this radar is to aid the pilot in avoiding thunderstorms and associated turbulence. Since each operator normally develops specific operational procedures for use of weather avoidance radar, the following information is presented for use at the operator's discretion.

Operational techniques for the RDR 2000 are similar to earlier generation weather avoidance radars. The proficient operator manages antenna tilt control to achieve best knowledge of storm height, size, and relative direction of movement.

RADAR PRINCIPLES

Radar is fundamentally a distance measuring system using the principle of radio echoing. The term RADAR is an acronym for RAdio Detecting and Ranging. It is a method for locating targets by using radio waves. The transmitter generates microwave energy in the form of pulses. These pulses are then transferred to the antenna where they are focused into a beam by the antenna. The radar beam is much like the beam of flashlight. The energy is focused and radiated by the antenna in such a way that it is most intense in the center of the beam with decreasing intensity near the edge. The same antenna is used for both transmitting and receiving. When a pulse intercepts a target, the energy is reflected as an echo, or return signal, back to the antenna. From the antenna, the returned signal is transferred to the receiver and processing circuits located in the receiver transmitter unit. The echoes, or returned signals, are displayed on an indicator.

Radio waves travel at the speed of 300 million meters per second and thus yield nearly instantaneous information when echoing back. Radar ranging is a two-way process that requires 12.36 micro-seconds for the radio wave to travel out and back for each nautical mile of target range. As shown in the distance illustration below, it takes 123.6 micro-seconds for a transmitted pulse of radar energy to travel out and back from an area of precipitation 10 nautical miles away.



WEATHER RADAR PRINCIPLES

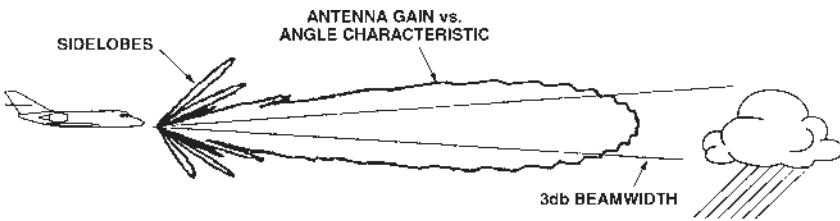
Airborne weather avoidance radar, as its name implies, is for avoiding severe weather, not for penetrating it. Whether to fly into an area of radar echoes depends on echo-intensity, spacing between the echoes, aircraft capabilities and pilot experience. Remember that weather radar detects only precipitation drops; it does not detect minute cloud droplets, nor does it detect turbulence. Therefore, the radar provides no assurance of avoiding instrument weather in clouds and fog. The indicator may be clear between intense echoes; this clear area does not necessarily mean it is safe to fly between the storms and maintain visual sighting of them.

The geometry of the weather radar radiated beam precludes its use for reliable proximity warning or anti-collision protection. The beam is characterized as a cone shaped pencil beam. It is much like that of a flashlight or spotlight beam. It would be an event of chance, not of certainty, that such a beam would come upon another aircraft in flight.

Note: *Weather avoidance radar is not practical as a pilot operable terrain or collision avoidance system. Weather analysis and avoidance are the primary functions of the radar system.*

RADAR BEAM ILLUMINATION

Probably the most important aspect of a weather radar is the antenna beam illumination characteristic. To make a proper interpretation of what you are seeing on the display, you must have an understanding of what the radar beam "is seeing". The following figure is a side view of the radar beam characteristic with a storm depicted at a distance that causes the size of the storm to just fill the 3 dB beamwidth. This would be the typical situation for a storm at approximately 40 nautical miles with a 12 inch diameter antenna. It's important to understand and visualize this situation, to enhance your understanding of the rest of this manual. First some observations are in order:



Note that the antenna gain versus angle characteristic is a continuous function at all angles. This means that there is a gain value associated with all forward angles relative to the selected tilt angle. In this figure the tilt angle is shown as zero degrees. This means the beam center is along the same angle as the aircraft flight angle. Next, the points on either side of the beam where the antenna gain is down 3 dB relative to the maximum gain defines the 3 dB beamwidth. The remainder of the manual uses the cone shaped 3 dB beamwidth extensively to illustrate how the beam spreads with distance, much like a flashlight beam. Also important is the understanding that this angle is wider for smaller antennas (10") and narrower for larger antennas. It's also important to realize that the antenna gain does not go to zero outside the 3 dB beamwidth, it just continues to reduce with increasing angles. This is what it meant by a continuous gain function. This understanding is important when we discuss ground clutter reflections later.

Also note that there are small lobes of the gain characteristic at fairly large angles. These are called sidelobes. Generally these are not important since the gain value for these lobes is down 25 or more dB from the peak. However a bad radome can increase these sidelobes to a point that they cause a constant radar reflection from the ground. This is commonly referred to as an "altitude ring" because the display will show a concentric ring at a distance equal to the slant range of the side-lobe to the ground.

The cone formed by the 3 dB beamwidth is where most of the radar energy is concentrated, so it is important to realize that at any given time whatever is within this cone (and sometimes other strong targets like clutter outside the cone) is what is being painted on the display. The pilot should be aware of how wide this cone is as a function of range. The primary target of interest is obviously weather cells of significance. The typical cell is considered to be 3 nm in diameter. It is mandatory that the beam be pointed at the wet part of the weather cell to record the proper rainfall intensity (color level). To aid the pilot at accomplishing this task, the "Radar Tilt Angle Calculator" tool is provided (P/N 006-18124-0000). This tool is a transparent 3 dB beamwidth overlay for each antenna size and range scales of 40, 80, and 160 nm in length, each of which has multiple weather cells shown to scale at different distances. A user can position the overlay on a given target and read the tilt angle that will position the beam at the "above freezing" part of the cell.

RADAR TILT ANGLE CALCULATOR USER INSTRUCTIONS

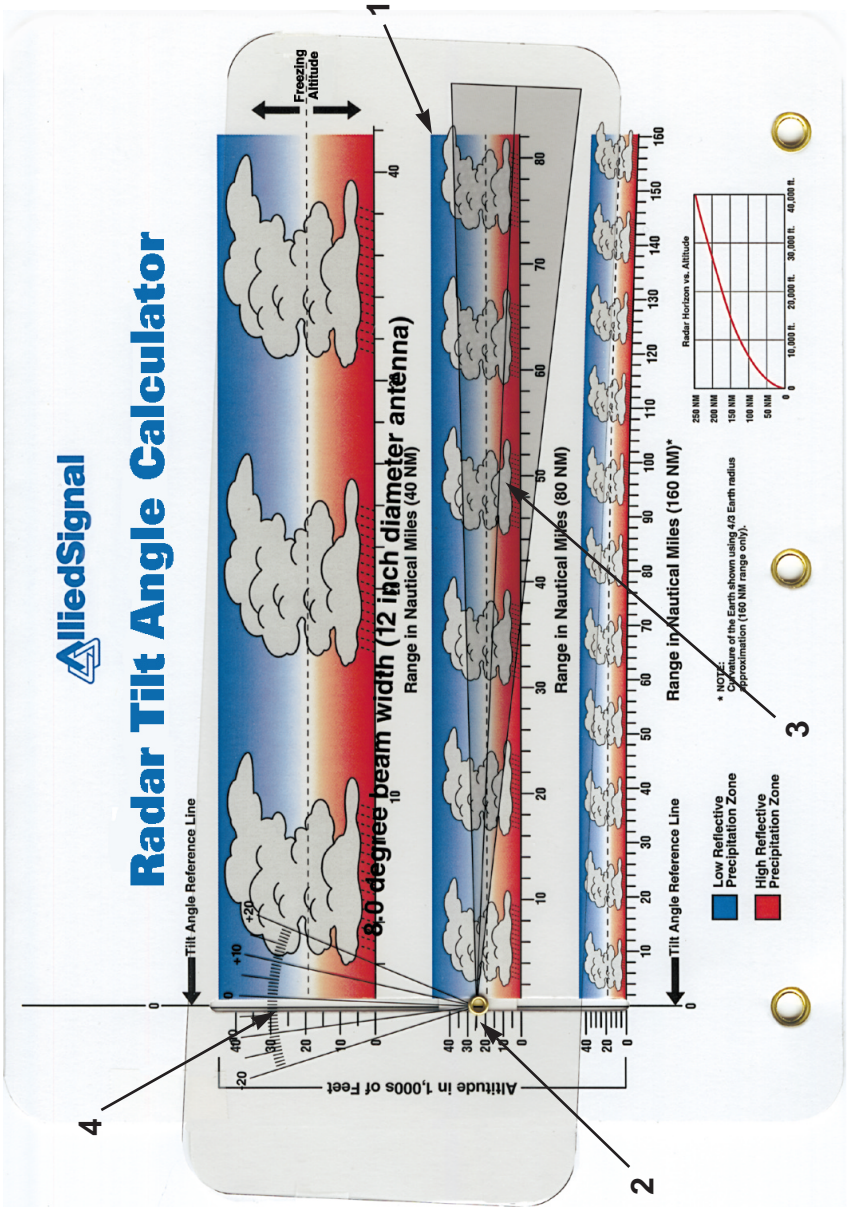
This instructional tool includes overlays for 10", 12" and 18" antennas. Use the overlay for the antenna size installed in the aircraft. If desired, the unwanted overlays may be detached by cutting the plastic of the unwanted overlay from the bottom edge to the fastener. Then, pull the plastic apart until it releases from the fastener.

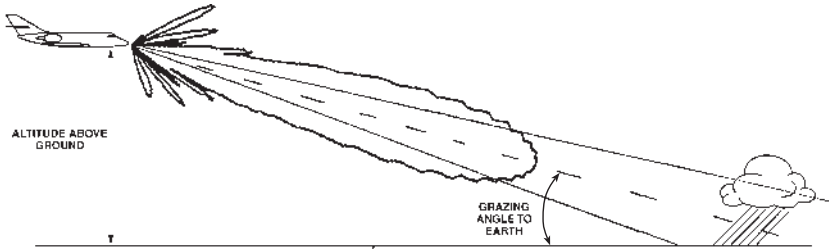
Use the following procedure while viewing the following diagram to determine the proper radar antenna tilt angle in a given situation:

- 1) Choose one of the three range diagrams that matches the range selected on the radar. In this case we have chosen the 80 nm scale diagram.
- 2) Slide the overlay so that the left indice aligns with the aircraft altitude. This is best done keeping the overlay parallel to the diagram and grasping the extension tab and the overlay at the time.
- 3) Now, tilt the overlay (without sliding it up or down) so that the center line of the radar beam intersects the red (below freezing altitude) part of the range diagram at the range of the echo in question displayed on the radar screen. The above freezing part of the thunderstorm cell gives the best reflectivity for radar energy.
- 4) The correct tilt angle is shown where the degree mark aligns with the Tilt Angle Reference Line.

Note: *To improve distinction between the weather echo and the clutter, increase the tilt angle. Remember, the correct weather intensity is shown at the tilt angle determined with the calculator.*

The higher the altitude, the more down tilt is required. Therefore, clutter distinction is more of a problem. In this case, the intensity of the weather displayed should be noted from the tilt angle shown on the calculator. Now raise the tilt angle to push the ground clutter out in range to separate it from the weather display. The echo intensity will appear to weaken because the radar is looking at the freezing part of the cell. Remember to also use Vertical Profile on suspected cells.

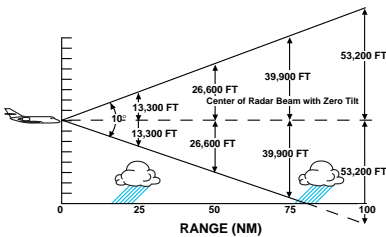




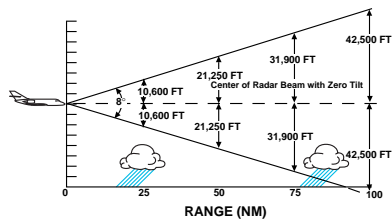
This tool should be understood and kept handy when trying to interpret the weather display. This tool illustrates that at greater distances, the weather cell doesn't fill the cone shaped beam. Under these conditions the distinction of the weather cell from the ground clutter is most difficult. The following figure illustrates this condition.

In this scenario the weather cell might be at 100 nm, the altitude might be 40,000 feet, and the appropriate tilt angle is approximately -3 degrees. Notice that the beam is centered on the rain but it also intersects the ground. The angle the beam makes with the ground is called the grazing angle. When this angle gets greater than about 2 degrees the ground reflections that return to the radar become very significant. A later section called "Tilt Management" discusses this difficult topic and makes some suggestions to help make weather/ground distinction.

The following diagrams show the beam width relationship with 10 inch, and 12 inch antennas. For illustrative purposes the aircraft are shown at approximately 40,000 feet and the tilt is set at zero degrees.



Radar Beam Illumination with 10 Inch Antenna

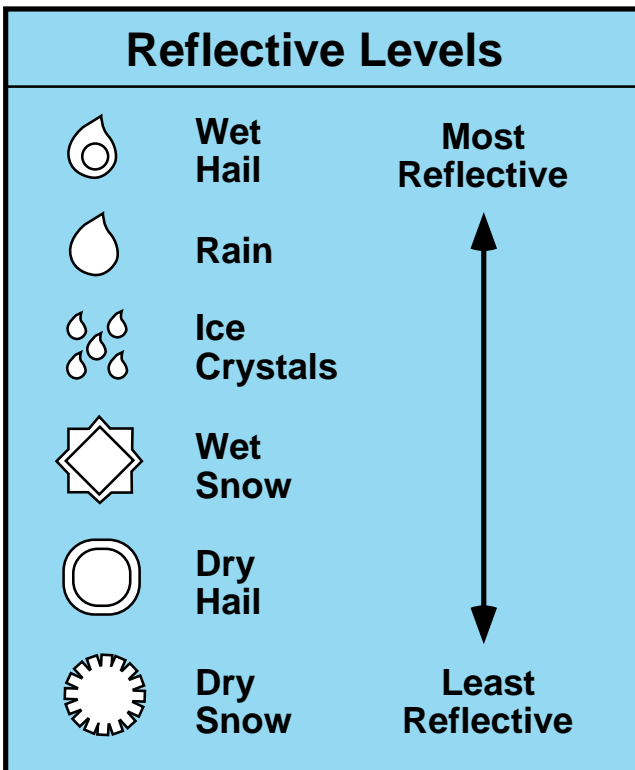


Radar Beam Illumination with 12 Inch Antenna

RADAR REFLECTIVITY

What target will reflect the radar's pulses and thus be displayed on the indicator? Only precipitation (or objects more dense than water such as earth or solid structures) will be detected by an X-band weather radar. Therefore weather radar does not detect clouds, thunderstorms or turbulence directly. Instead, it detects precipitation which may be associated with dangerous thunderstorms and turbulence. The best radar reflectors are raindrops and wet snow or hail. The larger the raindrop the better it reflects. Because large drops in a small concentrated area are characteristic of a severe thunderstorm, the radar displays the storm as a strong echo. Drop size is the most important factor in high radar reflectivity. Generally, ice, dry snow, and dry hail have low reflective levels and often will not be displayed by the radar.

A cloud that contains only small raindrops, such as fog or drizzle, will not produce a measurable radar echo. But if the conditions should change and the cloud begins to produce rain, it will be displayed on radar.



WEATHER DISPLAY CALIBRATION

The radar display has been calibrated to show five levels of target intensity: Black (level 0), Green (level 1), Yellow (level 2), Red (level 3), and Magenta (level 4). The meaning of these levels is shown in the following chart as to their approximate relationship to the Video Integration Processor (VIP) intensity levels used by the National Weather Service. These levels are valid only when; (1) the Wx and WxA mode are selected; (2) the displayed returns are within the STC range of the radar (approximately 40 miles); (3) the returns are beam filling; (4) there are no intervening radar returns.

Display Level	Rainfall Rate		Video Integrated Processor (VIP) Categorizations				Remarks
			Storm Category	VIP Level	Rainfall Rate		
	mm/Hr.	In./Hr.			mm/Hr.	In./Hr.	
4 (Magenta)	Greater Than 50	Greater Than 2	Extreme	6	Greater Than 125	5	Severe turbulence, large hail, lightning, extensive wind gust, and turbulence.
			Intense	5	50-125	2-5	Severe turbulence, lightning, organized wind gusts, hail likely.
3 (Red)	12-50	0.5-2	Very Strong	4	25-50	1-2	Severe turbulence likely, lightning.
			Strong	3	12-25	0.5-1	Severe turbulence, possible lightning.
2 (Yellow)	4-12	0.17-0.5	Moderate	2	2.5-12	0.1-0.5	Light to moderate turbulence is possible with lightning.
1 (Green)	1-4	0.04-0.17	Weak	1	0.25-2.5	.01-0.1	Light to moderate turbulence is possible with lightning.
0 (Black)	Less Than 1	Less Than 0.04					

***Radar Display and Thunderstorm Levels
Versus Rainfall Rates***

WEATHER ATTENUATION COMPENSATION

An extremely important phenomena for the weather avoidance radar operator to understand is that of attenuation. When a radar pulse is transmitted into the atmosphere, it is progressively absorbed and scattered so that it loses its ability to return to the antenna. This attenuation or weakening of the radar pulse is caused by two primary sources, distance and precipitation. The RDR 2000 has several advanced features which significantly reduce the effects of attenuation (no airborne weather radar can eliminate them completely). It is therefore up to the operator to understand the radar's limitations in dealing with attenuation.

Attenuation because of distance is due to the fact that the radar energy leaving the antenna is inversely proportional to the square of the distance. For example, the reflected radar energy from a target 60 miles away will be one fourth (if the target is beam filling) of the reflected energy from an equivalent target 30 miles away. The displayed effect to the pilot is that as the storm is approached, it will appear to be gaining in intensity. To compensate for distance attenuation both Sensitivity Timing Control (STC) and Extended STC circuitry are employed. The RDR 2000 has an STC range of 0 to approximately 40 nautical miles. Additionally, the radar will electronically compensate for the effects of distance attenuation with the net effect that targets do not appear to change color as the distance decreases.

Outside the STC range the Extended STC circuitry increases the displayed intensity to more accurately represent storm intensity. The Extended STC will not, however, totally compensate for distance attenuation and, therefore, targets in this range can be expected to show more detail as the distance decreases until reaching the STC range.

Attenuation due to precipitation is far more intense and is less predictable than attenuation due to distance. As the radar pulses pass through moisture, some radar energy is reflected. But much of that energy is absorbed. If the rain is very heavy or extends for many miles, the beam may not reach completely through the area of precipitation. The weather radar has no way of knowing if the beam has been fully attenuated or has reached the far side of the precipitation area. If this beam has been fully attenuated the radar will display a "radar shadow" which appears as an end to the precipitation when, in fact, the heavy rain may extend for many more miles. In the worst case, precipitation attenuation may cause the area of heaviest precipitation to be displayed as the thinnest area of heavy precipitation. It may cause one cell containing heavy precipitation to totally block or shadow a second heavy cell located behind the first cell and prevent it from being displayed on the radar. **Never fly into radar shadows** and never believe that the full extent of heavy rain is being seen on radar unless another cell or a ground target can be seen beyond the heavy cell. Proper use of the antenna tilt control can help detect radar shadows.

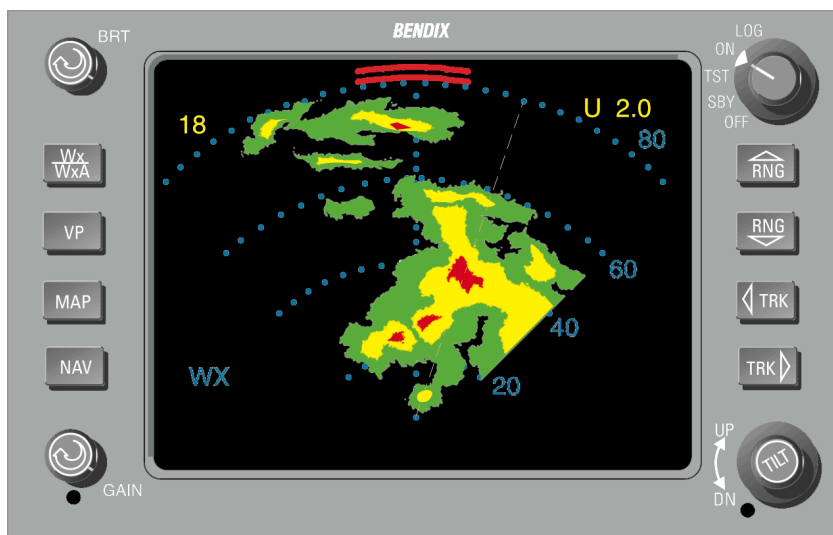
Attenuation can also be a problem when flying in a large area of general rain. If the rain is moderate, the radar beam may only reach 20 or 30 miles before it is fully attenuated.

The pilot may fly along for many miles seeing the same 20-30 nautical miles of precipitation ahead on the radar when, actually, the rain may extend a great distance. In order to aid in reducing the effects of precipitation attenuation, the RDR 2000 contains sophisticated weather attenuation compensation circuitry. The attenuation compensation feature is totally automatic in the Wx/WxA mode of operation and requires no pilot action to activate other than selecting Wx/WxA mode of operation. The compensation logic operates between 3 to 240 nautical miles, whenever a level 2 (yellow), 3 (red) or 4 (magenta) echo is displayed. The compensation circuits cause the software to measure each individual cell return and increase each individual cell return independently while the antenna scans the sector containing heavy rain. The compensation circuitry allows the radar beam to effectively look deeper into and through heavy rain to search for possible storm cells beyond. While attenuation compensation does not eliminate precipitation attenuation, it does allow the radar to see through more rain at short ranges where every bit of weather information possible is needed. If there is suspicion that the radar is attenuating due to precipitation, exercise extreme caution and ask ATC what they are showing. Often the ground based ATC controller's radar will have a better overall picture of a large rain area and the pilot can compare the controller's information with his own radar picture to avoid the strongest cells in a general area of rain.

TARGET ALERT

The RDR 2000 system can be configured at installation to include the Target Alert feature. The purpose of the feature is to alert the pilot to the presence of a significant weather cell that exists beyond the currently selected range. For this mode to be active, Wx or WxA mode must be selected and Vertical Profile must not be selected. The criteria for a Target Alert is for the cell to be at least red intensity, within $\pm 10^\circ$ of aircraft heading, a minimum size of 2 NM in range and 2 degrees in azimuth, and within the range of 80 to 240 NM. When a Target Alert is issued, two red arcs, separated by a black arc will be displayed at the top of the display centered on the aircraft heading (see the following figure). Target Alert is applied to each scan independent of the other when the radar is alternating scans.

Note: Target Alert is not active in the ground map mode.



ALTITUDE RING (RANGE RING)

Not all radar transmitted energy is contained in the main beam radiation pattern. Some of the energy is radiated in the side lobe pattern. The characteristics of some radomes and/or nose caps can cause detrimental side lobe radiation. Should this occur, the side lobe can be radiated down toward the earth and the reflected energy received by the radar may be displayed on the indicator as a narrow ring of video. When the indicator is on the 10 or 20 nm range, this can be seen at a distance corresponding to the altitude, typically one mile per 6000 feet. During "Wx" operation, when this phenomenon occurs, no appreciable degradation of the radar to depict weather exists. This phenomenon is largely dependent upon the shape and physical condition of the radome or nose cap on the aircraft.

RADOMES

A radome is a covering that shields the radar antenna from hostile environments, such as fast moving air, rain, bugs, and ice. It allows the microwave energy to pass through relatively undisturbed. This means that very little of the microwave energy passing through it will be absorbed, reflected, or redirected as a result of its presence. Some radomes closely approximate this definition, while others do not.

Here are some faults which can occur in radomes:

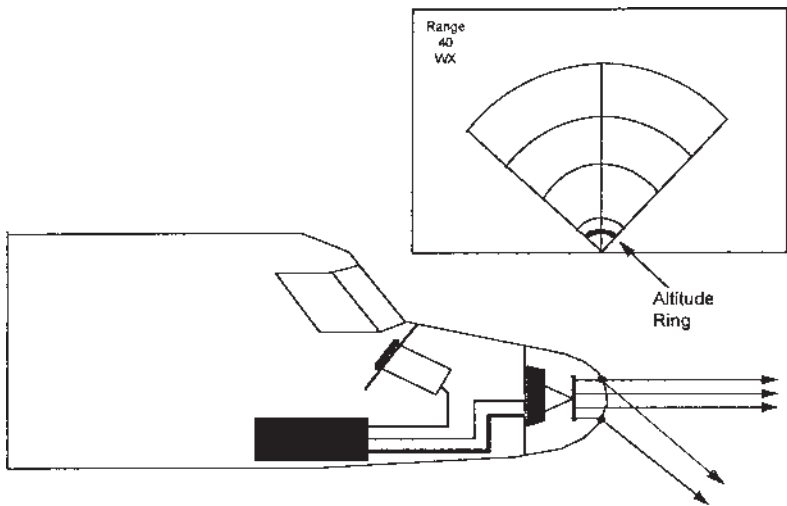
1. A pitted honeycomb radome can result from being struck by high velocity projectiles, such as rain, ice, sand, bugs, etc. Once the surface integrity has been broken, water intrusion can occur and cause significant radar signal loss.
2. A poorly sealed plastic radome nose boot which has allowed moisture to be trapped behind it.
3. Paint containing metallic particles mistakenly applied to all or part of the radome.
4. An improperly fabricated fiberglass radome.
5. A poorly repaired "ding" on the radome.
6. An object, usually metallic, located inside the radome and in the path of part of the transmitted microwave energy.

As a result of items 5 and 6 above, a "phantom ring" may appear on the radar display. Normally the cause is an obstruction in the bottom of the radome. This obstruction can cause some of the radiated energy to be directed down to the ground instead of in the forward direction. Reflective material in the top of the radome can result in the same situation. In either case, energy returns from the same direction that it was transmitted causing an "altitude ring" to be presented on the radar display.

play. It is called an altitude ring because it moves in and out as the aircraft changes altitude.

Items 1, 2, 3, and 4 can result in radar performance problems while checking out as "no trouble found" at the repair center. The radome is blocking too much energy.

Care must be exercised to be sure that only qualified personnel perform repairs on the radome. Also, it is time well spent during preflight to include checking the radome to be sure it remains in good repair. When examining the radome, be certain the radar is not transmitting microwave energy. See MPEL (Maximum Permissible Exposure Levels) in the Appendix.



WEATHER MAPPING AND INTERPRETATION

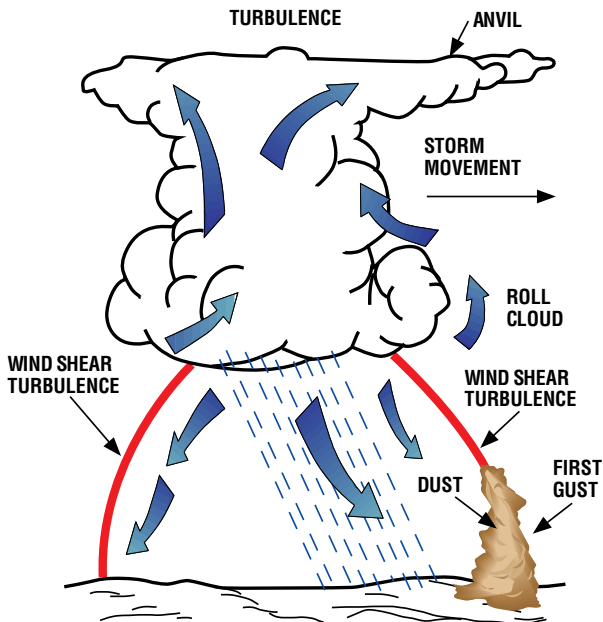
This section contains general information on use of radar for weather interpretation. Review of this information will assist the operator in using radar.

Note: The ability of a weather radar system to display weather returns is dependent upon the radome Transmission Efficiency. Bendix/King recommends a 90% average/85% minimum transmission efficiency. Refer to RTCA document DO-213 Class A for minimum operational performance standards for nose mounted radomes.

OBSERVING WEATHER

A weather avoidance radar is only as good as the operator's interpretation of the echoes that are displayed on the radar indicator. The operator must combine knowledge of how radar works and its limitations with such things as the prevailing weather pattern, and geographic location in order to make a sound interpretation of the displayed targets.

As a starting point the operator should read FAA Advisory Circular number 00-24B (Subject: Thunderstorms). It is also highly recommended that the operator take advantage of one of the commercially available weather radar seminars.



THUNDERSTORMS & TURBULENCE

The RDR 2000 can give you a clue to the presence of turbulence. Areas of the display where the colors change rapidly over a short distance represent steep rainfall gradients, which are usually associated with severe turbulence.

Turbulence may be divided into two basic types: (1) clear-air turbulence; and (2) turbulence associated with thunderstorms and precipitation.

The latter is most common. It is with this type that weather radar is most helpful to the pilot. It is not possible to detect clear air turbulence with this type of radar system. Weather guidance is now available from ground radar stations in some areas. However, this system suffers in comparison with the airborne weather radar where the weather is clearly visible on the pilot's indicator, instantly available for the pilot to act upon, considering his immediate circumstances and future flight planning.

The strong up and down drafts in a thunderstorm create very large raindrops which are usually displayed on a radar as level 4.

The probability of turbulence in these strong vertical gusts is great. The National Severe Storms Laboratory (NSSL) has found that the intensity level of the precipitation reflection correlates with the degree of turbulence found in a thunderstorm. The most severe turbulence in the storm, however, may not be at the same place that gives the greatest radar reflectivity.

The rate of change in rainfall rate laterally within a storm is called the rain gradient. This change will appear on the indicator as a change from green to yellow to red to magenta. If the rainfall rate increases from level 1 to 4 in a short distance, the rain gradient is steep and severe turbulence is often present. Avoid any storm with a steep rain gradient by an extra margin and especially avoid flying near the portion of the storm with the steepest gradient.

TORNADOES

It is possible that conclusive methods of detecting tornadoes with airborne radar may eventually be developed. However, evidence collected to date indicates tornadoes may be present if the following echoes are observed:

A hook-shaped pendant which may be 5 or more miles long and in the general shape of the numeral 6 strongly suggests the presence of a major tornado, especially if the pendant is bright and if it projects from the southwest quadrant (northeast quadrant in the southern hemisphere) of a major thunderstorm moving eastward. The pendant may be masked by ground clutter when viewed on the indicator and in some cases might

Weather Mapping and Interpretation

not be much more than a blunt projection or a scalloped edge of the parent thunderstorm echo.

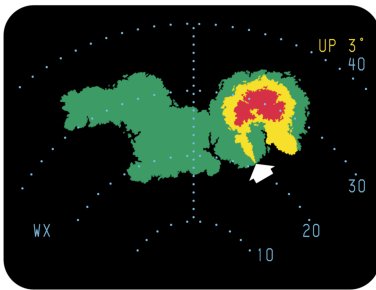
A crescent-shaped indentation on the side of a major thunderstorm echo 3 to 7 miles long is another possible identifier of an active or potential tornado in the vicinity.

The best procedure is to make wider than usual detours around sharp-edged thunderstorms and especially those which show projections or crescent-shaped indentations.

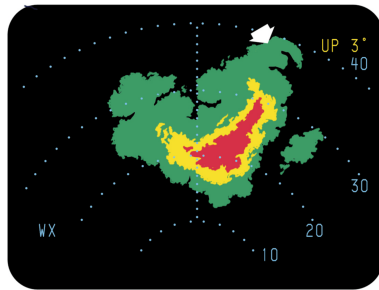
HAIL

Hail usually has a film of water on its surface, consequently, a hailstone is often reflected as a very large water particle. Because of the film and because hail stones usually are larger than raindrops, thunderstorms with large amounts of wet hail return stronger signals than those with rain. Although wet hail is an excellent reflector of radar energy, some hail shafts are extremely small (100 yards or less). These narrow shafts make poor radar targets.

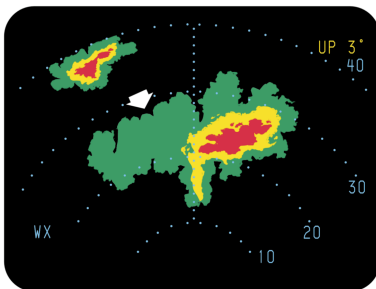
Hail shafts are usually identified with four different characteristic patterns: (1) fingers and protrusions, (2) hooks, (3) scalloped edges on the cloud outline and (4) U-shaped cloud edges 3 to 7 miles across.



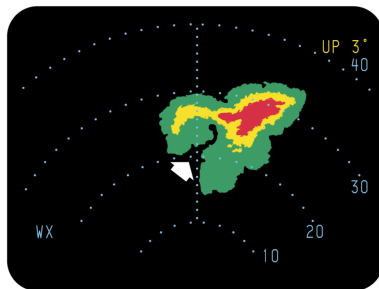
Finger



Hook



Scalloped Edge



U-Shaped

These echoes appear quite suddenly and along any edge of the storm outline. They also change in intensity and shape in a matter of seconds, and for this reason careful monitoring of the display is essential. It must be noted that weak or fuzzy projections are not normally associated with hail; however, such echoes should be watched closely for signs of rapid intensification.

The 40 nm operating range, with occasional up-tilt to check for fresh hail from above, will generally yield good results.

Note: *It takes an experienced eye to identify “hooks” and “fingers” and other radar echo characteristics which can indicate hail or tornadoes. However, the pilot can be sure that any echo with very ragged edges or rapid changes in shape or intensity will contain severe turbulence.*

ICING

There is reason to believe that radar will be of assistance in locating areas of heavy icing conditions. However, weather radar has not yet proved its ability to distinguish between super-cooled water droplets and ice crystals, since both are usually quite small. Needless to say, the operational problem in each case would be different. In the first case an icing condition would definitely exist but in the second case the pure crystals would offer no danger.

It should be remembered, however, that super-cooled water and ice crystals can co-exist. In each case the radar echo would be small or even non-existent due to the minute size of the free water particles. At this time, it appears that radar is not going to give warning for cloud icing unless it happens to be involved with active precipitation at the time. When precipitation is occurring, however, the areas of maximum ice exposure should appear as sandy or grainy echoes.

An icing condition that radar might possibly detect is the intermittent moderate or heavy icing condition associated with unstable air lifted by frontal action or orographic effects. In this situation the cumulus cells are hidden by surrounding cloud layers but could be spotted by radar. This would be of assistance in avoiding the moderate to heavy icing which occasionally occurs in cumulus clouds.

Note: *Thunderstorm icing can be extremely hazardous.*

SNOW

Dry snowfall has not been detected with any success on weather radar. However, a characteristic sandy or grainy echo identifies the presence of steady moderate to heavy wet snow. Such echoes are not readily obvious and require study of the display before they can be seen.

LIGHTNING AND STATIC DISCHARGES

Lightning and static discharges could scatter the display momentarily. However, the general presentation is unaffected and should return to normal within 1 scan.

Above all, remember: Never regard any thunderstorm as LIGHT, even when radar observers report the echoes are of light intensity. Avoiding thunderstorms is the best policy.

- DON'T attempt to preflight plan a course between closely spaced echoes.
- DON'T land or take off in the face of a thunderstorm in the projected flight path. A sudden wind shift or low level turbulence could cause loss of control.
- DON'T attempt to fly under a thunderstorm even if you can see through to the other side. Turbulence under the storm could be severe.
- DON'T try to navigate between thunderstorms that cover 6/10 or more of the display. Fly around the storm system by a wide margin.
- DON'T fly without airborne radar into a cloud mass containing scattered embedded thunderstorms. Scattered thunderstorms not embedded usually can be visually circumnavigated.

- DO avoid by at least 20 nautical miles, any thunderstorm identified as severe or giving an intense radar echo. This is especially true under the anvil of a large cumulonimbus.
- DO clear the top of a known or suspected severe thunderstorm by at least 10,000 feet altitude. This may exceed the altitude capability of the aircraft.
- DO remember that vivid and frequent lightning indicates a severe thunderstorm.
- DO regard as severe any thunderstorm with tops 35,000 feet or higher whether the top is visually sighted or determined by radar.

GROUND MAPPING AND INTERPRETATION

A secondary objective of the radar system is gathering and presentation of terrain data. This data is represented in the form of a topographical map that can be employed as a supplement to standard navigation procedures. Target quality affects the indicator display in various situations. Use of the GAIN and TILT controls will often improve picture contrast so specific ground targets are more readily recognizable.



Over Water - calm water or water with swells does not provide good returns. The energy is reflected in a forward scatter angle with inadequate portions being returned. The resulting display is “no target.”

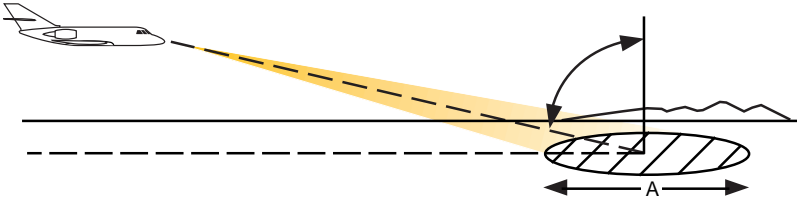
Choppy water provides better returns from the downwind sides of the waves. The resulting display is a target whose intensity will vary with the degree of choppiness.



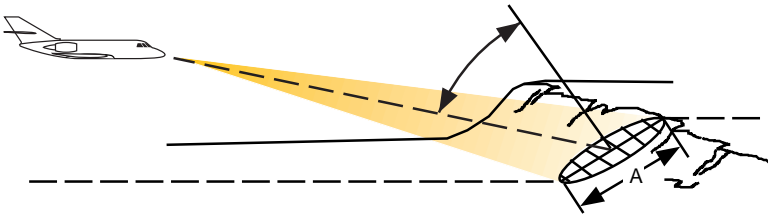
Over Terrain - Illumination of terrain results in a “diffused” reflection of the beam. A portion of this reflected energy is scattered back toward the antenna resulting in the prominent display of land features as well as lakes, large rivers, shore lines and ships.

LOOKING ANGLE

The incident angle at which the terrain is illuminated has a direct bearing on the detectable range and the area of illumination. A large incident angle gives the radar system a smaller detectable range of operation (due to a minimized reflection of direct radar energy). However, the illuminated area "A" is larger.



A smaller incident angle gives the radar a larger detectable range of operation because of an increase of direct radar energy reflected from the target to the antenna. The area of illumination ("A") is smaller.



Concentration of the beam energy on a small area of terrain increases the magnitude of the echo intercepted by the antenna. The resulting detectable range is therefore increased for mountainous terrain; the maximum distance at which this terrain can be monitored is greater because of the more direct reflection (or radar echo) produced. Illuminating the backslope of hills stretches the area of coverage beyond the flat terrain coverage.

OPERATION IN-FLIGHT

GENERAL

The RDR 2000 will provide you with target information to a greater degree of clarity than has ever been possible with previous generation weather avoidance radars. It is the purpose of this section to help you become a proficient radar operator as soon as possible. However, it is realized that proficiency can only improve with usage. It is, therefore, recommended that the operator become familiar with the operation of the system during fair weather instead of while trying to penetrate a storm front.

In previous sections of this handbook we have described the various controls and discussed the features of the RDR 2000 radar system. This section concerns itself with a more detailed discussion of some of these controls and how to make the most efficient use of them.

Note: *Your radar is a weather-avoidance device. It should never be used for weather-penetration. It will help you see and plan avoidance maneuvers around significant weather encountered during flight.*

TILT MANAGEMENT

Effective antenna tilt management is the single, most important key to more informative weather radar displays. Three prime factors must be kept in mind for proper tilt management:

- The earth's curvature must be considered in determining the location of the beam at long distances.
- The center of the radar beam is referenced to the horizon by the aircraft vertical reference system.
- Adjusting the antenna tilt control will cause the center of the radar beam to scan above or below the plane of the attitude reference system.

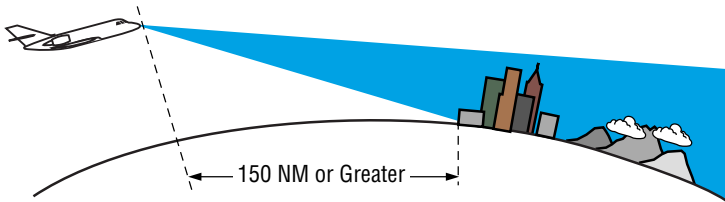
More simply, a too low setting will result in excessive ground or sea returns while a too high tilt setting (although excessive returns are eliminated) can result in the radar beam passing over the top of a weather target.

For detecting weather targets at long ranges and to allow adequate time for planning the proper avoidance path, the tilt angle should be set for a sprinkle of ground target returns on the display. By slowly raising the tilt angle, weather targets will emerge from the ground returns because of their height above the ground. In order to minimize ground returns when closely examining weather targets below the aircraft flight level, select the shortest range that allows full depiction of the area of interest.

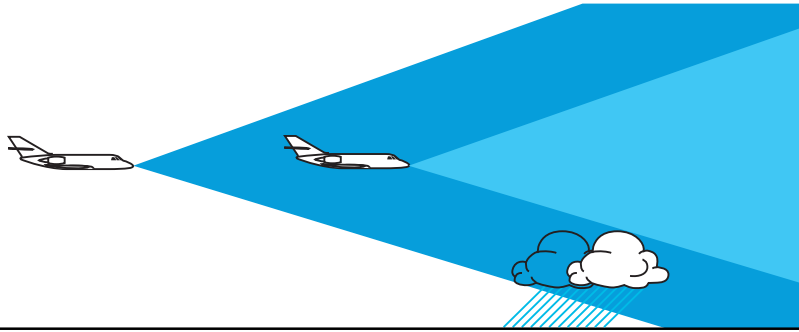
Operation In-Flight

In practice, when flying over fairly even terrain, ground returns are difficult to paint when the angle of incidence of the radiated beam becomes large (see Looking Angle pg. 22) and, therefore, causes the beam to travel almost parallel to the ground (see figure below.)

However, objects such as large buildings in cities, steep hills, mountains or storms will reflect the signal and can show strong returns at distances greater than those shown below.



Ground Returns and Tilt Management



Over-scanning and Tilt Management

When flying at high altitudes, the use of proper tilt management ensures observation of weather targets without over scanning. For example, a low altitude storm detected on the long range setting may disappear from the display as it is approached. While it may have dissipated during your approach toward the storm, don't count on it. It may be that you are directing the radiated energy from the antenna above the storm as you get closer. Judicious management of the antenna tilt control will avoid over-scanning a weather target.

Note: Please be aware that equivalent ground returns will require different tilt settings because of different ground reflectivities (for example, dry soil requires a different tilt setting than the more reflective tropical forest).

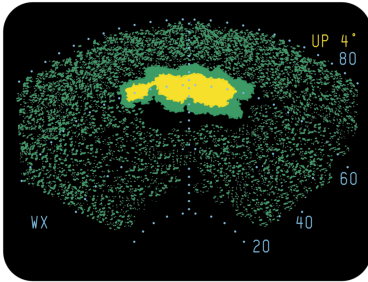
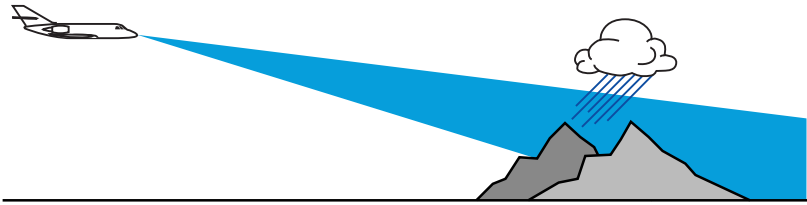
EARLY DETECTION OF ENROUTE WEATHER

To set the antenna tilt to optimize the radar's ability to quickly identify significant weather, follow these steps:

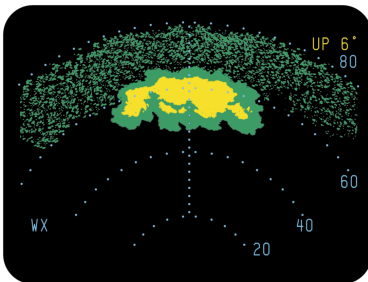
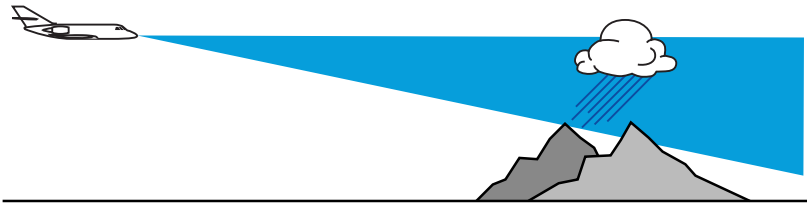
- 1) Select the Wx (weather) mode of operation. Adjust Brightness control as desired.
- 2) Select the 40 or 80 nm range.
- 3) Adjust the antenna tilt control down until the entire display is filled with ground returns.
- 4) Slowly work the antenna tilt up so that ground returns are painted on or about the outer one third of the indicator area.
- 5) Watch the strongest returns seen on the display. If, as they are approached, they become weaker and fade out after working back inside the near limit of the general ground return pattern, they are probably ground returns or insignificant weather. If they continue strong after working down into the lower half of the indicator, you are approaching a hazardous storm or storms and should deviate immediately.
- 6) Examine the area behind strong targets. If radar shadows are detected you are approaching a hazardous storm or storms and should deviate immediately, regardless of the aircraft's altitude. If weather is being detected, move the antenna tilt control up and down in small increments until the return object is optimized. At that angle, the most active vertical level of the storm is being displayed.
- 7) If a target is suspected to be a weather cell, but is partially obscured by clutter, move the track line over the target and select Vertical Profile. If the target is clutter, it will appear symmetrical about the ground return. If the target is weather, it will be asymmetrical and appear above the ground return (see the section on [Vertical Profile](#) for more information on this technique).

SEPARATION OF WEATHER AND GROUND TARGETS

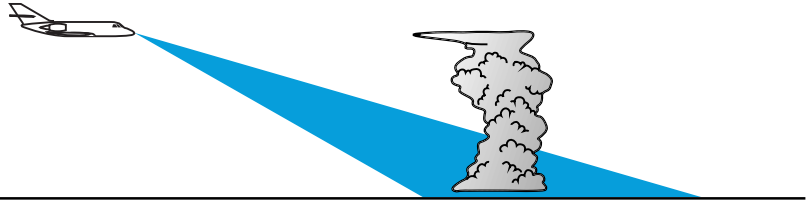
One of the most difficult tasks when using airborne weather radar is separating weather targets from ground targets. This is especially true since the maximum return from a storm cell occurs when the radiation beam is centered on the rainfall shaft. In many cases, this shaft may be no higher than 5,000 feet thus requiring some antenna down tilt to observe it. If you are flying at an altitude considerably above this, the antenna beam will also intersect the ground, thus masking the storm cells with ground targets. Proper adjustment of the antenna tilt will assist you in target separation.



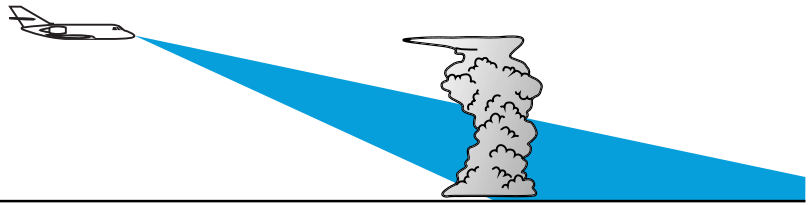
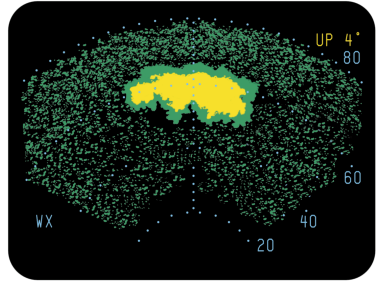
Significant weather will show a stronger return than ground return at shallow angles. A weather target will show as a solid mass while mountains will show a gap behind the peaks.



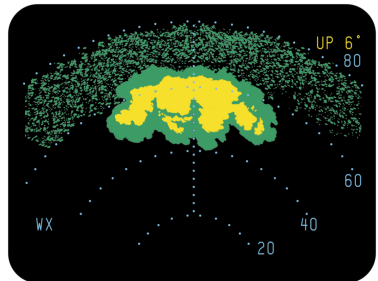
Raise tilt until a weather target emerges from the ground returns.



Raise tilt angle until weather is separated from the ground.



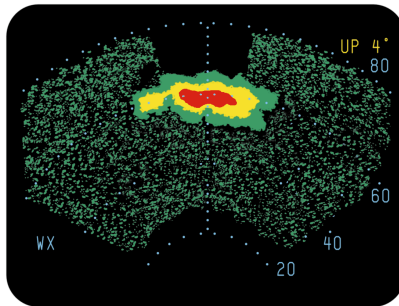
Note that displayed range of the ground target will increase as tilt angle is increased.



SHADOWED AREAS

Extremely heavy rainfall can reduce the ability of the radar energy to penetrate a weather cell and present a complete picture of the weather area. This condition is referred to as “radar attenuation”. Under these conditions ground returns can be helpful in analyzing the weather situation. Tilt the antenna down and observe the ground returns around the displayed cell. If no ground returns are displayed on the far side of the displayed cell (shadowed area), heavy rain may be blocking the radar energy. This could mean that a larger area of precipitation exists than that which is displayed.

WARNING: AVOID AND NEVER PENETRATE A SHADOWED AREA.



TARGET RESOLUTION

The ability of a weather avoidance radar system to resolve and display two or more closely spaced targets is limited in range by the transmitted pulse width and display range and in azimuth by the antenna beam width.

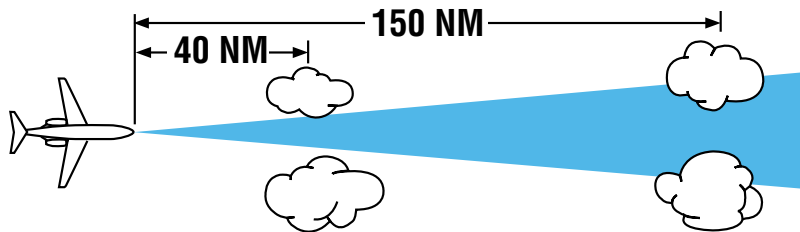
RANGE RESOLUTION

The transmitter pulse width in the RDR 2000 is 4 micro-seconds, yielding a receiver range resolution of approximately 1/3 nautical mile.

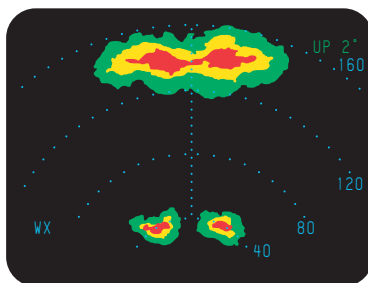
AZIMUTH RESOLUTION

The ability of the radar to resolve adjacent targets in azimuth is a function of the beam width of the antenna and the range to the target. As can be seen in the adjacent table, the diameter of this radiated beam increases as it gets further away from the aircraft.

Antenna Size	Beam Width	25 NM	50 NM	100 NM	200 NM
Beam Diameter (NM)					
10"	10.0°	4	8	16	32
12"	8.0°	3	6	12	24



Targets separated by a distance less than the beam diameter (at the target distance) will merge and appear on the indicator as "one."



PATH PLANNING

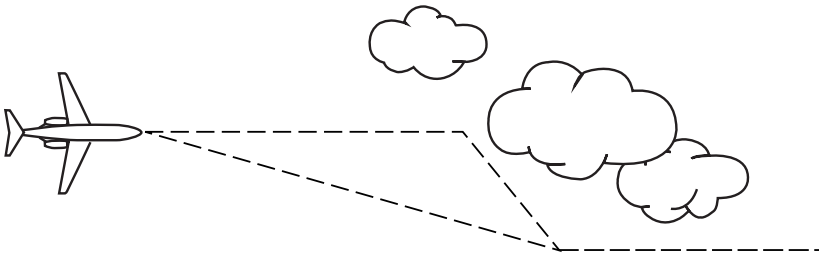
Remember to plan a deviation path early. Simply skirting the red or magenta portion of a cell is not enough. Plan an avoidance path for all weather echoes which appear beyond 100 nautical miles since this indicates they are quite intense.

The most intense echoes are severe thunderstorms. Remember that hail may fall several miles from the cloud, and hazardous turbulence may extend as much as 20 nautical miles; therefore, echoes should be separated by at least 40 nautical miles before you fly between them. As echoes diminish in intensity, you can reduce the distance by which you avoid them.

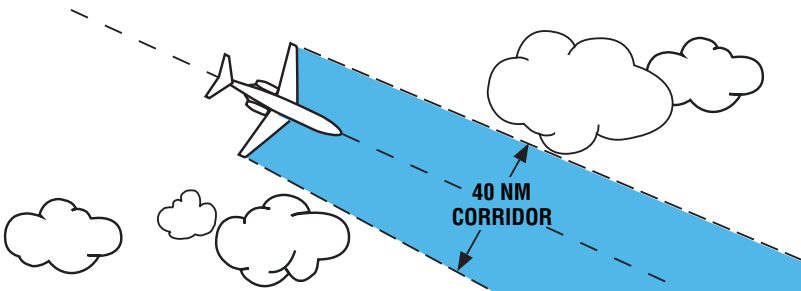
PATH PLANNING CONSIDERATIONS

- Avoid cells containing magenta and red areas by at least 20 nautical miles.
- Do not deviate downwind unless absolute necessary. Your chances of encountering severe turbulence and damaging hail are greatly reduced by selecting the upwind side of the storm.
- If looking for a corridor, remember corridors between two cells containing magenta and/or red areas should be at least 40 nautical miles wide from the outer fringes of the radar echo. The magenta displays areas of very heavy rainfall and statistically indicates a high probability of hail.

Note: Do not approach a storm cell containing magenta and red any closer than 20 nautical miles. Echoes should be separated by at least 40 nautical miles before attempting to fly between them.

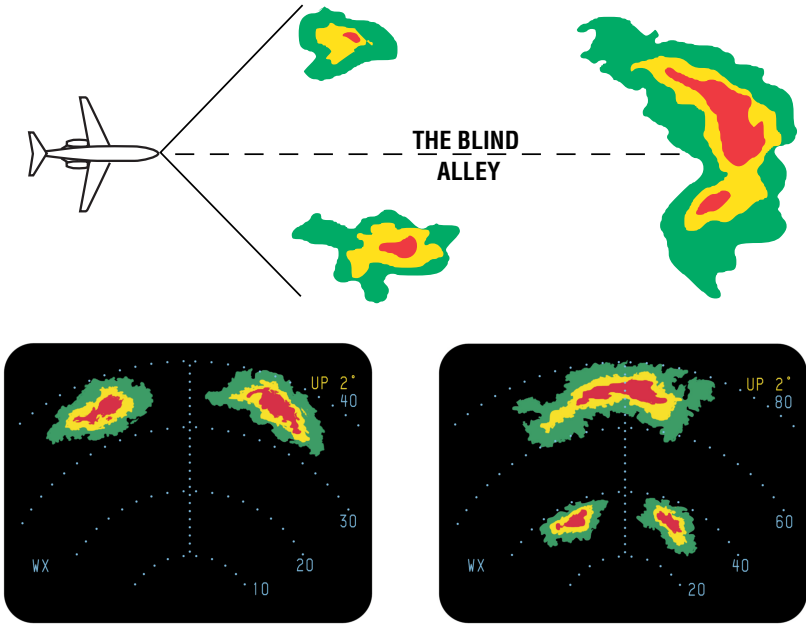


Cells beyond 75 nautical miles are areas of substantial rainfall, do not wait for red or magenta to appear. Plan and execute evasive action quickly to minimize "doglegging."



When a complete detour is impractical, penetration of weather patterns may be required. Avoid adjacent cells by at least 20 nautical miles.

A “Blind Alley” or “Box Canyon” situation can be very dangerous when viewing the short ranges. Periodically switch to longer-range displays to observe distant conditions. As shown below, the short-range returns show an obvious corridor between two areas of heavy rainfall but the long-range setting shows a larger area of heavy rainfall.



ANTENNA STABILIZATION

CRITERIA

Automatic antenna stabilization, as employed in today's weather avoidance radar, consists of an electro-mechanical means of maintaining a selected beam scan relative to the earth's horizon during moderate aircraft maneuvers. To accomplish this, a reference is established by the aircraft's vertical gyro, usually a component of the auto pilot or integrated flight control system.

Any aircraft may experience a noticeable amount of gyro drift during extended periods of turning flight. If you do encounter a vertical gyro which precesses abnormally during maneuvering flight (as evidenced on the artificial horizon in either pitch or roll) but subsequently precesses to normal attitude during straight and level flight, degrading gyro performance is indicated. This type of poor gyro performance does not usually result in a catastrophic gyro failure, but rather a continued gradual degradation.

PITCH ERRORS

As the aircraft accelerates during takeoff, the gyro will precess in pitch. As soon as the aircraft speed becomes steady, the accrued pitch error will start diminishing. Average time required for the gyro to stabilize after takeoff will vary with acceleration time and rate. Acceleration and deceleration on approach can also cause the gyro to precess slightly. This precession problem is greater on jet aircraft because of their rapid acceleration capabilities.

TURN ERRORS

If a turn is accomplished after takeoff while the gyro is off vertical due to takeoff acceleration, the pitch error will be translated into the roll axis and will be observed as a roll attitude error when compared to the natural horizon. The roll error starts disappearing the moment the aircraft resumes straight and level flight.

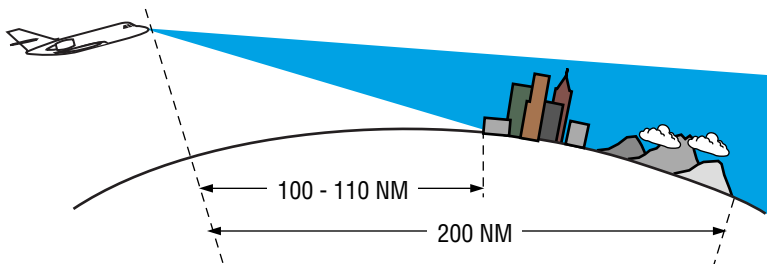
In turns made with less than a 6 degree bank (for example, intercepting a VOR with a shallow cut), the gyro continues to sense the lateral acceleration (lateral force) and, as a result, precesses in the same direction as the bank. If the turn is continued at the same indicated bank angle, the actual bank assumed by the aircraft will steepen at the same rate the gyro is precessing. When the aircraft is returned to straight flight and brought to wings level via the turn-and-bank indicator or the natural horizon (if visible) the roll error accumulated during the turn will be observed on the horizon indicator and will remain for a period of time unless a fast recovery technique is employed.

EFFECT ON RADAR STABILIZATION

Previously discussed gyro precession errors will directly affect radar stabilization, and therefore the quality of return seen on the indicator. Radar on aircraft flying at high altitude is normally operated on the 80 to 240 nm range with the antenna tilted down slightly so the radar beam is just above the point of painting ground returns.

A 1/2 degree gyro error in roll during alignment would be hardly noticeable on the horizon indicator, but with the radar operating on the 160 nm range, it could result in almost 40 nautical miles of ground returns on one side and no ground returns on the other.

In practice, when flying over fairly even terrain, ground returns are difficult to paint when the angle of incidence of the radiated signal becomes large (see Looking Angle pg. 22) and, therefore, causes the beam to travel almost parallel to the ground. See the figure below.



The vertical gyro is designed to sense verticality within 1/2 degree under normal operating conditions. Perfect radar antenna stabilization requires the following accuracies: the vertical gyro must maintain exact verticality, the antenna mounting bracket must be leveled perfectly to coincide with the gyro mounting base, the elevation servo amplifiers must be balanced precisely with a sharp null (no dead band at null position), antenna follow-up signals must be linear over the full range of the antenna tilt, and the antenna must be adjusted properly with no backlash (play) in the elevations gear train. Even though extreme care is used during overhaul and adjustment of the equipment, minute variations can be cumulative, resulting in small stabilization errors.

If ground returns appear on one side first as the antenna tilt is lowered, continue lowering the tilt until ground returns are visible on the other side; if the difference in tilt is 2 degrees or less, the antenna can be tilted up to clear the ground returns with satisfactory radar operation. Differences greater than 2 degrees warrant corrective action, assuming proper gyro stabilization in level flight.

The following information on radar operation during aircraft maneuvers may be helpful.

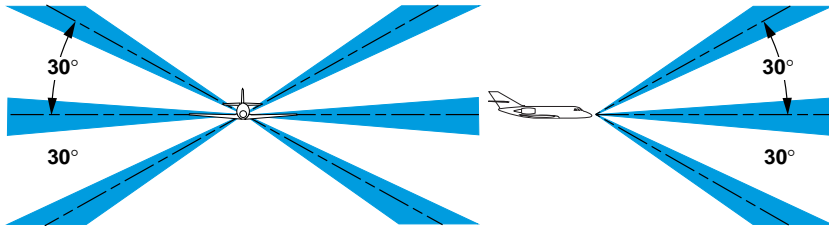
Antenna Stabilization

DURING TAKEOFF

Since there is no advantage in having the antenna tilt level while at low altitudes, raising the antenna tilt to clear ground returns caused by gyro acceleration error will result in satisfactory radar operation. Tilt can then be readjusted as the vertical gyro stabilizes. Turns during climb-out, while pitch acceleration error exists, will also cause a stabilization error in the roll axis.

SHALLOW-BANKED TURNS

If the aircraft is held in a shallow bank attitude, gyro precession will cause ground returns to appear. This can be overcome by raising the antenna tilt 1 or 2 degrees until the aircraft is out of the turn and the gyro has stabilized. In addition to any gyro error, radar stabilization is further affected by antenna mechanical limits of ± 30 degrees.



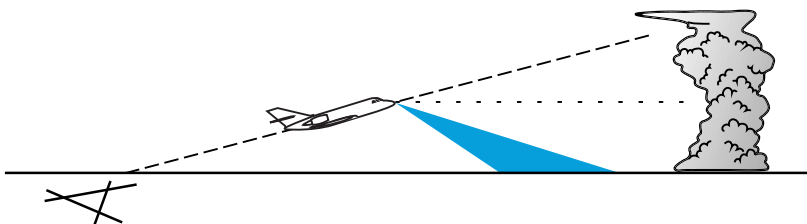
STABILIZATION LIMITS

Stabilization limitations of the antenna beam may be exceeded during aircraft maneuvers. These limitations are mechanically fixed at 30 degrees from zero degrees. Combinations of pitch/roll and tilt which exceed this limitation will diminish stabilization effectiveness. Pitch/roll is a complex quantity, not an arithmetic sum. However, as a rule-of-thumb, for small pitch angles, the sum of tilt and bank angles being less than 20 degrees, is within limits.

If the pilot changes the aircraft attitude so as to exceed the combined tilt, pitch and roll limits (± 30 degrees) of the radar's stabilization system, the message, "STAB LMT", will appear at the lower right corner of the display during the time the limit is exceeded. Please note that during portions of the antenna sweep, the calculated antenna elevation angle may not exceed the limit. Therefore, the "STAB LMT" will not be displayed. The "STAB LMT" message will disappear completely when the aircraft attitude is restored to within the system's operational limits.

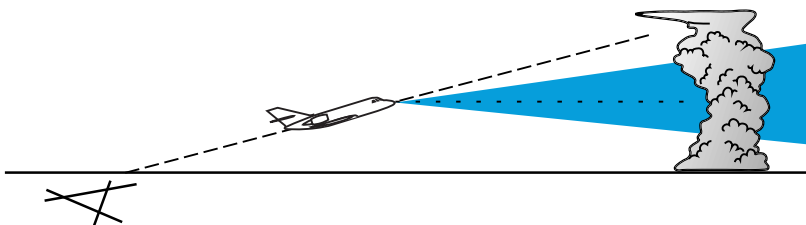
Gyro precession may be experienced during take-off or prolonged aircraft maneuvers such as rapid descents, etc. Precession error may

introduce a three to five degree antenna stabilization error which may persist as long as 5 minutes after the maneuver. Precession error results in a “lopsided” antenna scan; low on one side, high on the other. If the picture is extremely “dirty” in the forward area-antenna looking at terrain rather than precipitation-use a slight degree of up tilt. In the azimuth scan area near 45° left or right, the beam tilt is close to that indicated.



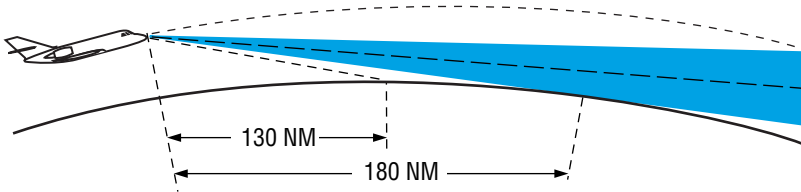
A rapid climb profile dictates that the tilt should not remain in the up position for extended periods. As the aircraft altitude progressively increases, the possibility of over scanning weather cells also increases. The effective storm height is progressively reduced by the aircraft altitude.

- Adjust radar and obtain weather picture before takeoff.
- Plan wide clearance of cells.
- Compensate antenna tilt for gyro precession.
- Evaluate weather in the immediate sphere of operation.
- Do not “over-scan” weather targets.
- During excessive aircraft maneuvers, recognize the limitations of stabilization.

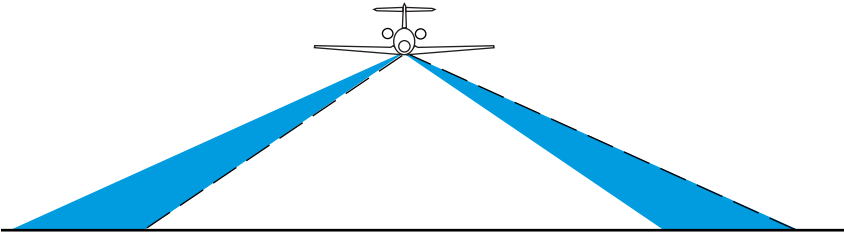


Antenna Stabilization

Stabilization of the radar beam compensates for moderate aircraft maneuvers. The Line-of-Sight system used is not absolute, but has limitations. Recognize limitation errors. Errors in the order of one-half degree or less can produce this effect. With the beam just contacting the horizon at 180 nautical miles, a 1/2 degree of further down tilt moves this contact point in to 130 nautical miles. Isolated terrain targets would now appear.



Introducing a 1/2 degree roll error compounds the effects; down on one side, up on the other side (1 degree unbalance).



STABILIZATION FLIGHT TEST CHECKLIST

1. Fly the aircraft being tested to 10,000 feet AGL .
2. Select the MAP mode, STAB OFF, and set the indicator to 20 nm.
3. Set manual gain to maximum.
4. While flying level (0 degree pitch, 0 degree roll), adjust the tilt control for a video pattern shown in Figure 1.

Note: Record tilt position for future reference.

5. If the inner ring of video is not parallel to the range marks, the mounting of the antenna is not parallel to the horizontal axis of the aircraft.

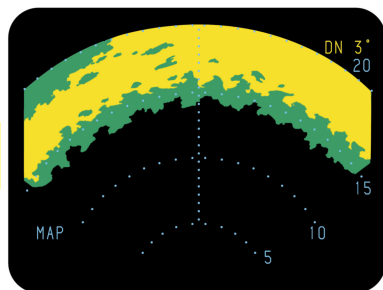


Figure 1

6. Turn the STAB on. If the pattern appears as Figure 2 or 3, the RDR 2000 can compensate for this using ROLL TRIM. Adjust the ROLL TRIM with a small screwdriver through access on radar indicator controller until [figure 1](#) is achieved.
7. Roll the aircraft gently to the right auto pilot bank angle.

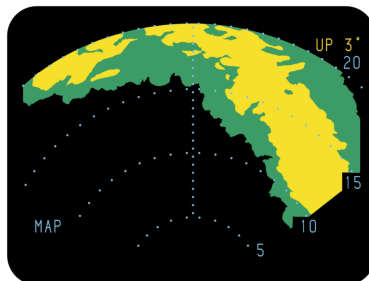


Figure 2

8. For perfect stabilization, the pattern shown in [Figure 1](#) should not shift. The information displayed will change, however, the inner extremity should remain coincident with the third range mark.
9. If the pattern shifts as shown in Figure 2, increase the tilt angle until the edge of the video pattern reaches the same position as the center was before the roll maneuver. Note the new position of the tilt control. Proceed to step 11.

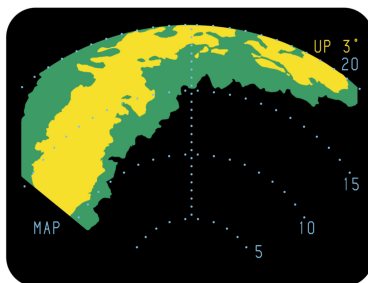


Figure 3

10. If the pattern shifts as shown in Figure 3, decrease the tilt angle until the edge of the video pattern reaches the same position as the center was before the roll maneuver. Note the new position of the tilt control. Proceed to step 11.

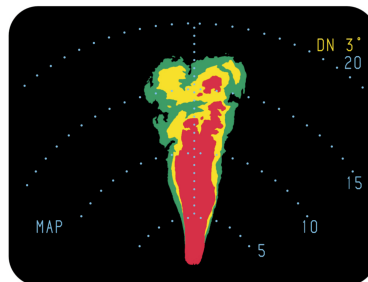


Figure 4

11. If the differences between Steps 9 and 4 or 10 and 4 are greater than 2 degrees the system should be ground checked to recalibrate the roll stabilization circuitry to the gyro.
12. If the pattern shifts per Figure 4, there is no roll stabilization and the system should be ground checked per the Installation Manual.
13. Check pitch performance as follows: Re-establish [Figure 1](#) by flying straight and level. Momentarily pitch the aircraft up 5 degrees (no more than 10 to 20 seconds to minimize altitude change). If the inner ring of clutter moves further out in range, readjust the tilt downward until the pattern returns as it was before the pitch maneuver. Note the tilt change. If the clutter moved inward, adjust the tilt upward and note the change. If the tilt change is greater than 2 degrees, the system should be ground checked to recalibrate the pitch.

VERTICAL PROFILE (VP) THEORY OF OPERATION

Note: A VP compatible indicator is required to display in VP mode.

The primary use of the RDR 2000 is to aid the pilot in avoiding thunderstorms and associated turbulence. All normal weather radar principals apply to the Vertical Profile feature incorporated in the RDR 2000 radar. It is therefore important to become familiar with the theories of basic radar principles, beam illumination, radar reflectivity, display calibration, weather attenuation compensation, weather mapping and interpretation, ground mapping and target resolution.

The operational difference between the standard weather avoidance radar and the RDR 2000 is the additional ability to vertically scan the antenna up and down with respect to the aircraft center line and process the vertical slice of information for display in a meaningful format.

VP OPERATION IN-FLIGHT

VERTICAL PROFILE

The single most important key to deriving pertinent, usable information from weather radar is proper tilt management. This formerly complex procedure is greatly simplified by the RDR 2000 Vertical Profile feature.

With conventional non-VP weather avoidance radars, setting the antenna tilt angle too low results in excessive ground or sea returns. Setting the angle too high eliminates the excessive return problems, but may result in the radar beam passing over the top of a weather target. The proper antenna tilt angle is directly dependent on a given storm's range from the aircraft and its height, width, depth and intensity. Upon selecting the desired tilt, the pilot must rely on his ability to interpret the limited display information. For detailed information on tilt management and interpretation of display information, refer to the [Tilt Management](#) section under Operation In-Flight.

The Vertical Profile feature of the RDR 2000 provides a direct means of displaying the vertical characteristics of the weather cell. Storm characteristics of particular interest to the pilot include relative height, slant, shape, vertical development and the area of most concentrated precipitation within the storm. In addition to providing information about the storm's vertical characteristics, the pilot can now easily distinguish between ground or sea returns and actual weather. In dual indicator installations, the normal azimuth scan may be viewed on one indicator and Vertical Profile on the other. With this information at hand, the pilot can develop a mental, three-dimensional picture of the storm.

OPERATION

Whether you are a highly experienced weather avoidance radar operator or are using radar for the first time, you will find operating the Vertical Profile feature easy. In fact, most will find that Vertical Profile simplifies normal operation.

The best time to begin using Vertical Profile is on a nice sunny day when the pilot work load will allow time to experiment with the new feature. Start out by adjusting the tilt angle to a normal setting.

TRK - Press and hold either the TRK (track) left or TRK (track) right button. A yellow line will appear on the screen and start to slew in the direction selected. In the upper left corner of the display a yellow numeric annunciation will display the number of degrees left or right of the aircraft nose the track line is positioned. To stop the track line at a desired position, release the track button. If a TRK button is not pressed for 15 seconds, the track line will disappear from the display.

VP - Once the desired azimuth is selected with the TRK button, press the VP button to enter the Vertical Profile mode of operation. When VP is selected the Vertical Profile screen will appear on the indicator and the radar will provide a vertical scan of ± 30 degrees at the location of the horizontal track line.

Selecting the Vertical Profile mode of operation will not change the selected mode of operation displayed in the lower left corner of the display (TST, Wx, WxA or GND MAP). Once in Vertical Profile, these modes may be changed as desired. Vertical Profile will engage from the NAV MAP mode, but NAV data will be disabled during Vertical Profile operation.

Note: *VERTICAL PROFILE OPERATIONAL ADVISORY: The RDR 2000 is a weather analysis and avoidance tool. It should never be used for pre-planned penetration of storms. However, in the event of required navigation in areas of bad weather, the proper use of this tool can reduce the likelihood of encountering excessive precipitation and turbulence. The RDR 2000 radar greatly simplifies the task of determining vertical characteristics of a storm by pictorially displaying a vertical slice of the cell and showing its radar height. The accuracy of radar height is limited by beam illumination and range resolution. Since cloud tops composed of ice crystals or dry hail, both of which have low radar reflectivity, or storm associated turbulence without precipitation may extend several thousand feet or higher, appropriate caution must be exercised when attempting to over fly any cell which exhibits high radar reflectivity or extends above the freezing level. Vertical Profile is not intended to measure the absolute height of a storm although it can be useful in determining relative radar heights of different cells. Flying near or under a thunderstorm should never be attempted, even if radar returns are weak at low levels, due to the possibility of extreme turbulence and windshear.*

Lateral clearance of at least 20 nautical miles is recommended for all storm cells providing red or magenta level returns.

Note: *The NAV MAP mode is disabled during Vertical Profile operation.*

A few seconds will normally elapse before the display will paint the Vertical Profile radar returns. This delay is due to the time it takes the antenna to move to the selected azimuth position to begin the vertical scan pattern.

Once Vertical Profile is selected, the desired profile position may be moved left or right in azimuth by pressing and holding the TRK button. The selected azimuth position (i.e. track line position) is shown on the upper left corner of the display.

Note: *Vertical Profile is most useful in the wings level operation mode. During a turn, constant adjustment of the track button would be required to view the same area of a given cell. Roll stabilization is not functional during Vertical Profile operation; therefore during a roll, the Vertical Profile slice angle equals the bank angle of the aircraft providing a skewed Vertical Profile display.*

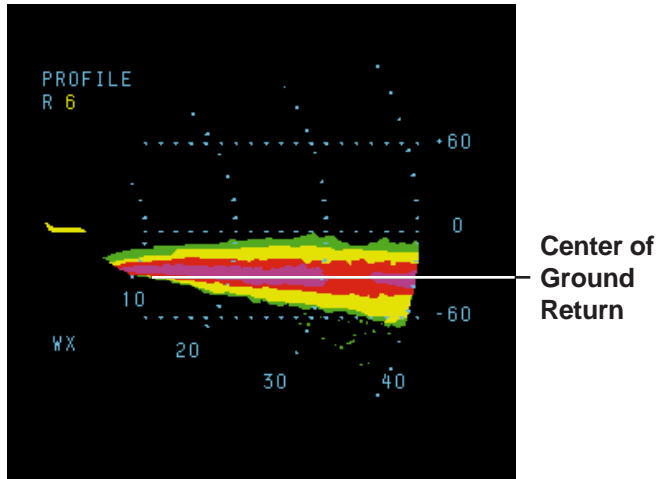
To terminate the Vertical Profile mode and return to horizontal scanning operation, press the VP button. The radar system will remain in the same mode (Wx, WxA, MAP or TEST) of operation and same range scale as it was in Vertical Profile.

If you have completed the above operations in flight on a sunny day as suggested, you have experienced the simple operation of Vertical Profile and observed display of ground paint similar to that shown in [Figure 5](#). The understanding of this very basic presentation is an important key in interpreting low level weather.

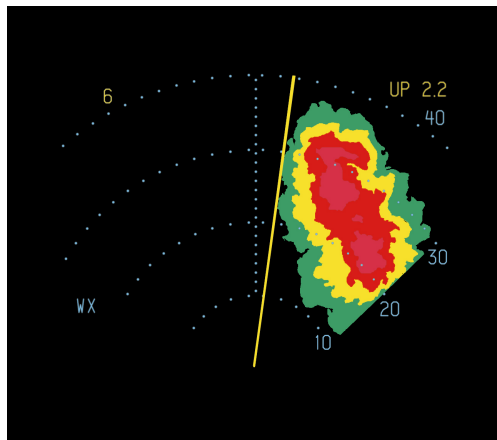
To improve your use and understanding of Vertical Profile, adjust the tilt angle to ground map a city or mountain. Use the TRK buttons to select the ground map target, and activate Vertical Profile by pressing the VP button. Depending on range, altitude and magnitude of the ground mapped target, the display should now resemble [Figure 6](#). Note the differences between Figure 5 and 6. However, at the location of the ground mapped target the image is still symmetrical. The symmetrical display is key in distinguishing the differences between ground returns (ground, cities, and mountains) and low level weather.

[Figures 5 through 10A](#) illustrate normal horizontal scan and Vertical Profile scan examples of various returns from different weather patterns encountered during actual flights with the RDR 2000.

Note: *Cell intensity (color threshold) in VERTICAL PROFILE may appear different than cell intensity in horizontal mode. The beam passes upward through varying reflective levels (see chart on page 11). When scanning horizontally, the level remains constant.*

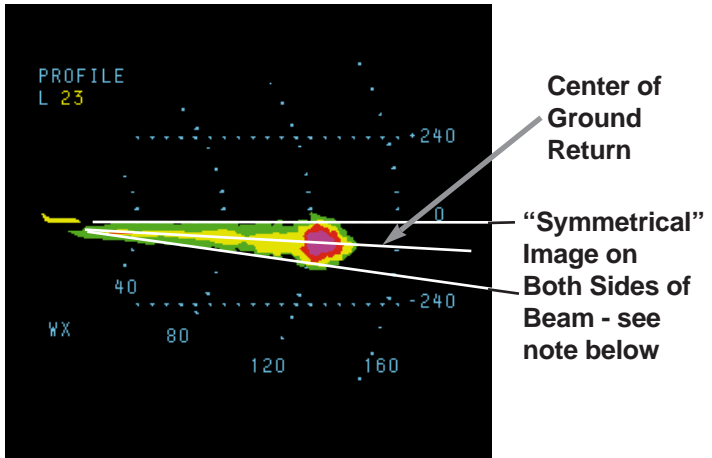


**Figure 5: Vertical Profile View
Ground Returns
Aircraft at 20,000 feet MSL**

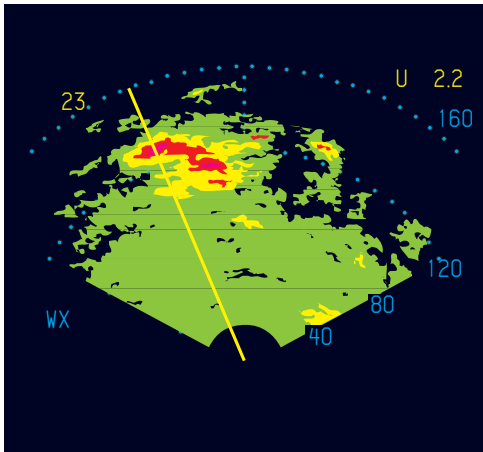


**Figure 5A:
Standard Azimuth View
Aircraft at 20,000 feet MSL**

Figure 5: 40 nm range selected showing normal ground returns over that terrain. The aircraft is at 20,000 feet MSL. The flashlight like beam image provides a good representation of the radar beam characteristics. The center line of this image is the ground. As the beam is scanned over the ground the solid returns create a mirror image above and below the ground level providing reflectivity equal to the beam width and power level. As aircraft altitude and range increase, the ground returns will decay in much the same way as they increased from where the beam first intersected the ground.



**Figure 6: Vertical Profile View
Ground Mapping Denver & Mountains
Aircraft at 20,000 feet MSL**



**Figure 6A: Standard Azimuth View
Ground Mapping Denver & Mountains
Aircraft at 20,000 feet MSL**

Figure 6: 160 nm range selected showing normal ground returns over flat terrain with Denver and the background mountains displayed as strong symmetrical ground returns at 130 nautical miles. The aircraft is at 20,000 feet MSL. When the beam shows a symmetrical image about the ground return center line, either the returns are from a very solid object such as the ground or a very intense low level close in storm.

Note: The image will be symmetrical in ground map mode and slightly truncated at the bottom side of the return in Wx Mode.

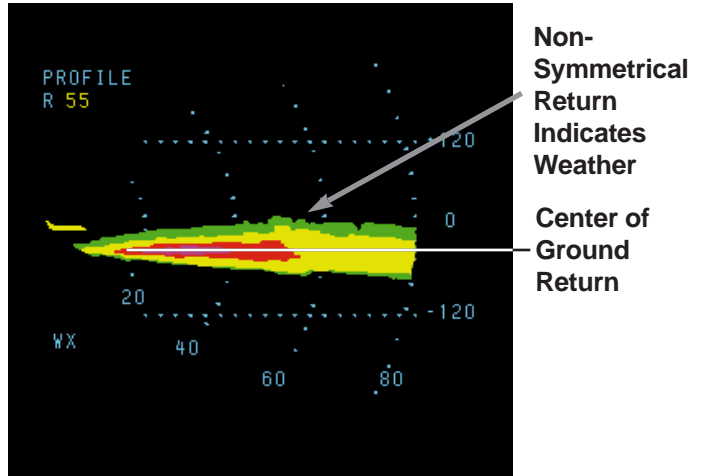


Figure 7:
Vertical Profile View
Isolated Low Level Weather
Aircraft at 20,000 feet MSL

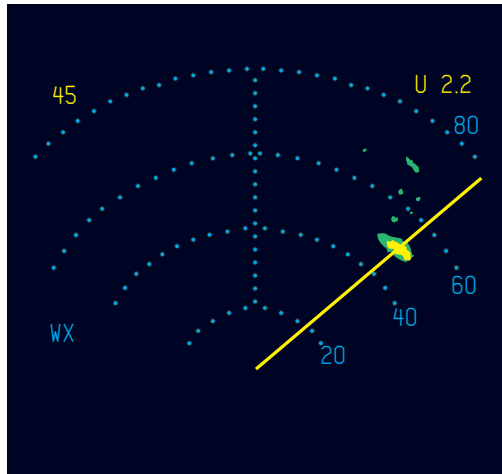


Figure 7A
Standard Azimuth View
Isolated Low Level Weather
Aircraft at 20,000 feet MSL

Figure 7: 80 nm range selected showing normal ground returns over flat terrain. An isolated low level storm at 50 nautical miles is depicted by the non-symmetrical return. The aircraft is at 20,000 feet MSL.

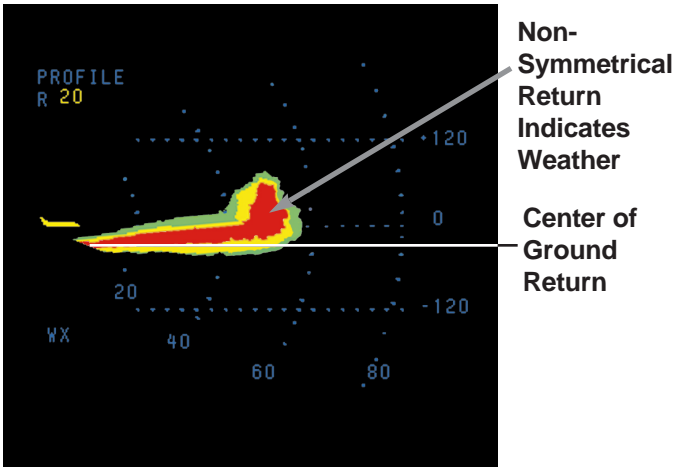


Figure 8
Vertical Profile View
Strong Weather Line
Aircraft at 20,000 feet MSL

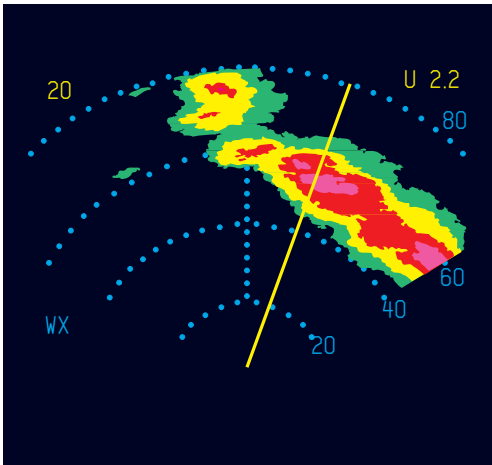
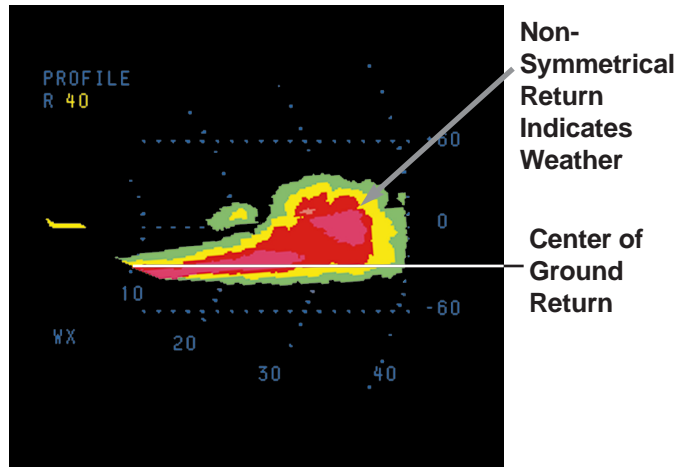
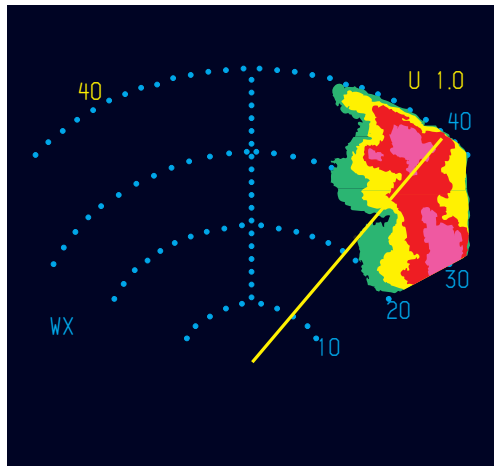


Figure 8A
Standard Azimuth View
Strong Weather Line
Aircraft at 20,000 feet MSL

Figure 8: 80 nm range selected showing normal ground returns out to 60 nautical miles. An intense high-level storm is depicted by the non-symmetrical returns. The aircraft is at 20,000 feet MSL.

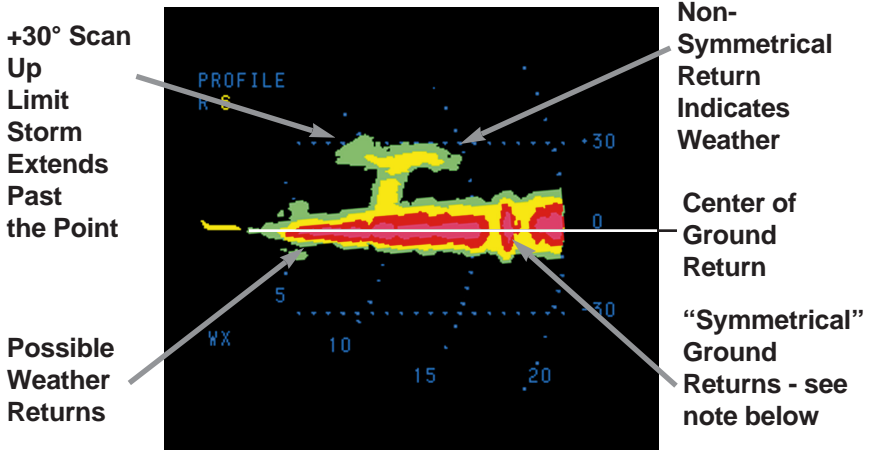


**Figure 9: Vertical Profile View
Strong Weather Returns
Aircraft at 20,000 feet MSL**

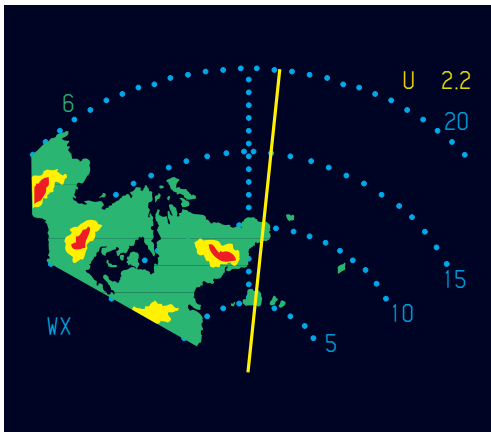


**Figure 9A: Standard Azimuth View
Strong Weather Returns
Aircraft at 20,000 feet MSL**

Figure 9: 40 nm range selected showing normal ground returns out to 25 nautical miles. At 20 nautical miles the RDR 2000 shows an area of isolated precipitation between the aircraft and the major storm which starts at 25 nautical miles. This “Roll Cloud” is a fairly typical phenomenon associated with severe weather. The aircraft is at 20,000 feet MSL.



**Figure 10: Vertical Profile View
Low Level Weather & Ground Returns
Aircraft on Ground at Fort Collins
Loveland, Colorado**



**Figure 10A: Standard Azimuth View
Low Level Weather Ground Returns
Aircraft on Ground in Fort Collins
Loveland Colorado**

Note: The image will be symmetrical in ground map mode and slightly truncated at the bottom side of the return in Wx Mode.

Figure 10: 20 nm range selected, aircraft on the ground at Fort Collins Loveland, Colorado airport. Strong symmetrical ground returns are depicted out to 20 nautical miles. A shaft of precipitation approximately 3 nautical miles wide starts at 9 nautical miles, rises and mushrooms. An interesting point to note between the azimuth and VP presentation is the

storm depth painted. The Vertical Profile presentation depicts the storm tops to be 7 nautical miles deep while the azimuth view depicts a storm depth of 2 nautical miles. The selected tilt angle would account for this discrepancy. The vertical scan in the Vertical Profile mode of operation is up and down 30 degrees. Normal azimuth scan tilt adjustment is up and down 15 degrees, which limits the upward scan and ability to paint the higher level development of the storm as depicted in Vertical Profile presentation.

Between 3 and 5 nautical miles the low altitude areas of precipitation are detected. Due to their proximity to the ground and aircraft, sufficient returns are detected to provide the symmetrical returns we normally associate with ground returns.

WEATHER RADAR INTERFERENCE

There are at least four common types of external interference that may cause spokes to appear on the radar display.

The first type of interference is referred to as CW (Continuous Wave). Figures 11 through 14 show variations of this type of interference. One possible source is ground based microwave data links. Another source is various kinds of military equipment.

The most common type of CW interference appears as a wedge on the radar display (see Figure 12). In rare cases the entire display may be washed out momentarily. If the wedge-type source of interference happens to be located in the aircraft flight path, the interference may last for thirty minutes or more.

If the CW interference comes from a ground based source, the azimuth angle of the wedge will change as the aircraft flies past the source location (see Figures 12 and 14). Frequently, when a radar system is experiencing this type of interference, spokes of lesser intensity will be observed at various off-beam-axis angles. In other words, there will be a high intensity spoke with one or more lower intensity spokes at different azimuth angles

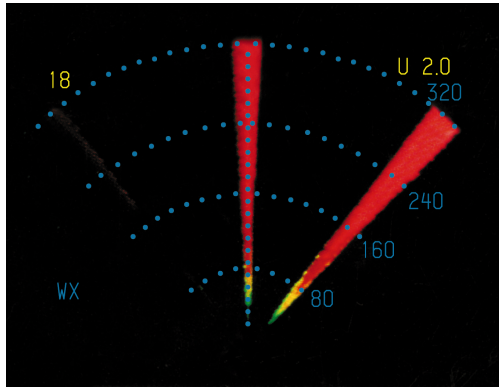


Figure 11: Possible Jammer

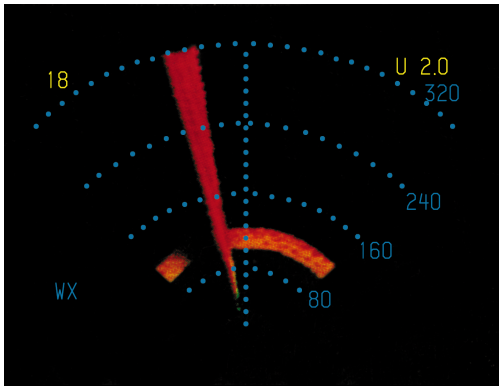


Figure 12: CW Interference

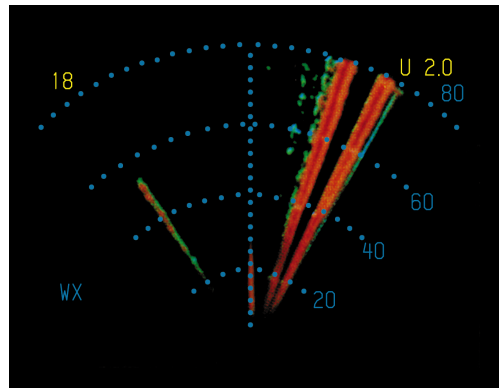


Figure 13: CW Interference (Possible Jammer)

(see Figures 13 and 14). This phenomenon results from the side-beam characteristics of the antenna.

If the source of interference is an airborne jammer, multiple spokes may be displayed as in Figures 11 and 13. Normally, adjusting the antenna tilt angle to extreme up or down angles will reduce, or even eliminate, this type of interference.

The second type of radar interference comes from other weather radars operating within the area. All radar systems have a low-power CW oscillator within the system. Some of the power emitted from this oscillator is continually radiated from the antenna. These oscillator emissions are well below the level which will harm an individual, but well above the sensitivity of a nearby weather radar. When some weather radars are in the TEST mode, the CW oscillator periodically scans the entire range of frequencies normally used by weather radar systems. When one of these systems is in your area and operating in the TEST mode, a spoke may appear on the display when the other system scans through the RDR 2000 operating frequency (see Figure 15). This condition will most likely occur before takeoff or when landing in the vicinity of other weather radar equipped aircraft. Adjusting antenna tilt angle will not have much effect in remedying this situation. However, once airborne extreme tilt angle adjustment can reduce or eliminate this interference.

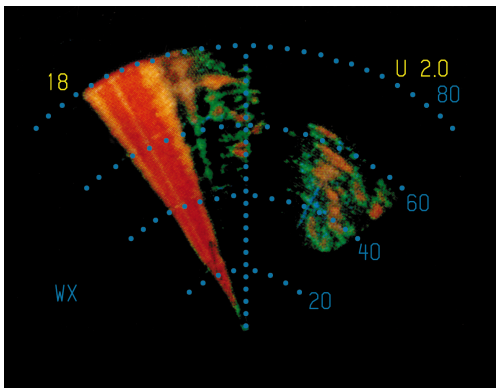


Figure 14: CW Interference with Side-Beam Characteristics

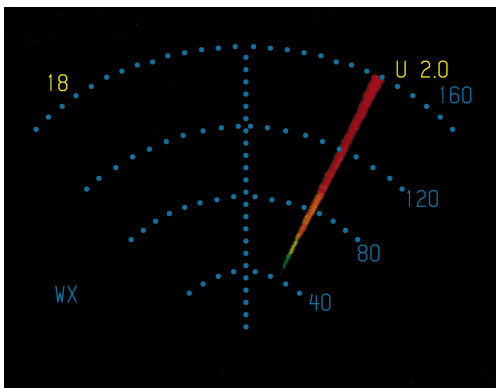


Figure 15: Another Weather Radar's CW Oscillator Interference

Weather Radar Interference

The third common source of interference occurs when another weather radar system with similar characteristics is transmitting in the area. Figure 16 shows what is displayed in this situation. These are commonly referred to as “rabbit tracks”. Again, while the aircraft is on the ground antenna tilt angle adjustment will have little effect, but once airborne extreme tilt angle positions will be more effective toward removing this interference from the display.

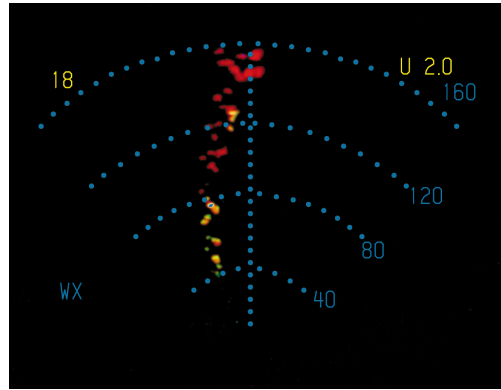


Figure 16: Rabbit Tracks

The fourth source of interference, as shown in Figure 17, is the result of another pulse-type radar system operating at a much higher transmission rate than the RDR 2000. This type of spoke is normally 3 to 12 degrees wide in the azimuth direction. The same interference reduction techniques described earlier will also work well here.

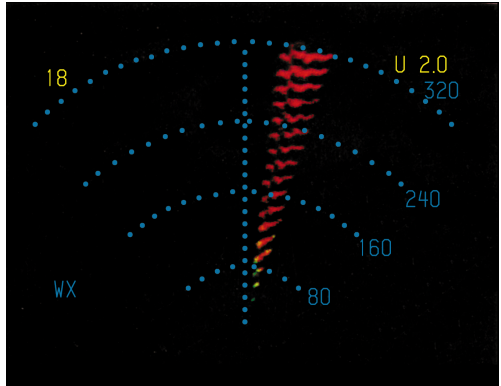


Figure 17: Interference from Radar with High Transmission Rate

OPTIONS

CHECKLIST

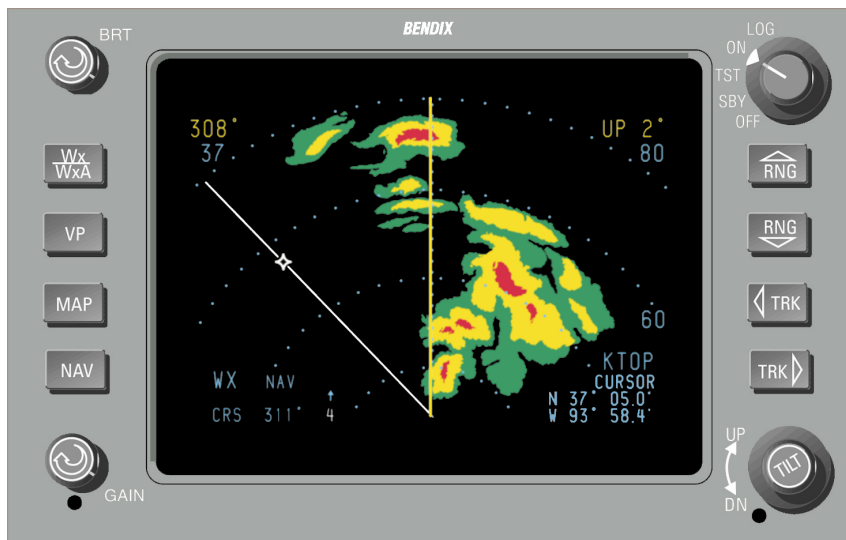


With an optional checklist unit installed, the pilot is provided with up to 935 lines of programmable information. These pages may be custom programmed by the pilot for the specific aircraft's performance specifications.

When the checklist is switched ON, the radar screen will display checklists. Note that the radar does not transmit when the checklist is displayed.

Selecting the checklist overrides all other indicator displays. To restore control to the radar system, turn the checklist to standby or to off.

MOVING-MAP NAVIGATION



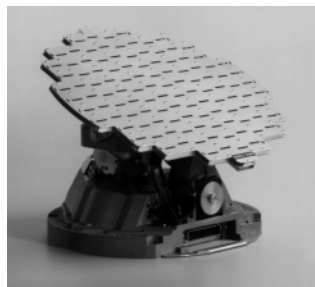
When your radar is equipped with the proper Bendix/King radar graphics unit (IU-2023B, GC-360A, GC-381A) with a Bendix/King Flight Management System (KNS-660, KNS-81, KLN-88, KLN-90/B, KLN 900, GNS-XLs) or NAV System (KNR 634A, KDM 706A or DM 441B), it is possible to display one or more way points as well as the flight path to the way points.

Refer to the pilot's manuals on these units for details of their operation.

Warning: With the proper interface unit or Flight Management System connected to the radar system the radar will not transmit in the Log mode. However, if these systems are not connected the radar is capable of transmitting in Log mode.

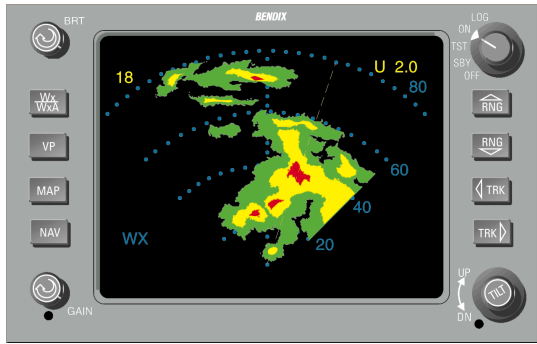
SPECIFICATIONS

RDR 2000 SENSOR (ANTENNA, RECEIVER, TRANSMITTER)



Performance Index - 10 inch	209.9 \pm 2.5 dB
- 12 inch	212.7 \pm 2.5 dB
Displayed Weather Ranges	10,20,40,80,160, 240 nm
Weather Colors	5 Including Black
Vertical Profile	\pm 30°
Ground Map Variable Gain	0 to -20 dB (configurable at installation)
Attenuation Compensation	3 to 240 nm
Peak Output	3.5 kW, nominal
Pulse width	4 micro-seconds
PRF	106.5 \pm 5 Hz
Antenna Size	10-in, or 12-in.
Antenna Scan Angle	90° or 100° (configurable at installation)
Antenna Scan Rate	25° per second
Tilt Angle, Manual	15° up to 15° down
Stabilization	\pm 30° combined pitch, roll & tilt
Stab. Adjustments (non-volatile)	Stored in Configuration Module (part of aircraft installation)
Power Requirements	28 VDC, 3.0A
Weight - radar 2000	9.9 lbs
Altitude	55,000 ft. unpressurized
Temperature Range	-55 to +70°C
TSO:	C63c Class 7
DO 160C Environmental Categories	
	F2-BA(CLMY)E1XXXXXA(BZ)(AB)(BZ)ARA(A2C2)XX

Specifications



INDICATOR IN-182A

Display Ranges	10, 20, 40, 80, 160, 240 nm (weather) (up to 1000 nm for navigation only)
Power Requirements	28 VDC, 2.0A Continuous
Weight	8.9 lbs (4.0 kg)
Altitude	25,000 ft. unpressurized
Temperature Range	-20 to +55°C
Size	4.11 in (10.44 cm) H x 6.4 in (16.28 cm) W x 12.57 in (32.38 cm) L w/connector
TSO:	C63 b Class 7
DO 160A Environmental Categories	A1B1/A/PKS/XXXXXXABABA

APPENDIX: LICENSE REQUIREMENTS

An aircraft radio station license is required to operate this system when installed in an aircraft. The Federal Communication Commission (FCC) has type-accepted and entered this equipment as "King Radio Corporation" FCC ID# ASYART2000. When completing form 404, Station License Application, use the exact description.

The FCC requires that the operator of the radar receiver-transmitter in this system hold a Restricted Radio Telephone Operator's permit or higher class license. This permit or license may be obtained from the nearest field office of the Federal Communication Commission. No examination is required, but the applicant must be a U.S. citizen.



ADVISORY CIRCULAR

DEPARTMENT OF TRANSPORTATION
Federal Aviation Administration
Washington, D.C.

SUBJECT: Recommended radiation safety precautions for ground operation of air borne weather radar
Initiated by: AFO-512

PURPOSE. This circular sets forth recommended radiation safety precautions to be taken by personnel when operating airborne weather radar on the ground.

CANCELLATION. AC 20-68A, dated April 11, 1975, is canceled.

RELATED READING MATERIAL.

- a. Barnes and Taylor, Radiation Hazards and Protection (London: George Newnes Limited, 1963), p. 211.
- b. U.S. Department of Health, Education and Welfare, Public Health Service, Consumer Protection and Environmental Health Service, "Environmental health microwaves, ultraviolet radiation and radiation from lasers and television receivers - An Annotated Bibliography", FS 2.300: RH-35, Washington, U.S. Government Printing Office, pp. 56-57.
- c. Mumford, W.W., "Some technical aspects of microwave radiation hazards", Proceedings of the IRE, Washington, U.S. Government Printing Office, February 1961, pp. 427-447

BACKGROUND. Dangers from ground operation of airborne weather radar include the possibility of human body damage and ignition of combustible materials by radiated energy. Low tolerance parts of the body include the eyes and testes.

PRECAUTIONS. Management and supervisory personnel should establish procedure for advising personnel of dangers from operating airborne weather radars on the ground. Precautionary signs should be displayed in affected areas to alert personnel of ground testing.

General.

- (1) Airborne weather radar should be operated on the ground only by qualified personnel.
- (2) Installed airborne radar should not be operated while the aircraft is in a hangar or other enclosure unless the radar transmitter is not operating, or the energy is directed toward an absorption shield which dissipates the radio frequency energy. Otherwise, radiation within the enclosure can be reflected throughout the area.

Body Damage. To prevent possible human body damage, the following precautions should be taken.

- (1) Personnel should never stand nearby and in front of radar antenna which is transmitting. When the antenna is not scanning, the danger increases.
- (2) A recommended safe distance from operating airborne weather radars should be established. A safe distance can be determined by using the equations in Appendix 1 or the graphs of figures 1 and 2. This criterion is now accepted by many industrial organizations and is based on limiting exposure of humans to an average power density not greater than 10 milliwatts per square centimeter.
- (3) Personnel should be advised to avoid the end of an open wave guide unless the radar is turned off.
- (4) Personnel should be advised to avoid looking into a wave guide, or into the open end of a coaxial connector or line connector to a radar transmitter output, as severe eye damage may result.
- (5) Personnel should be advised that when power radar transmitters are operated out of their protective cases, X-rays may be emitted. Stray X-rays may emanate from the glass envelope type pulsar, oscillator, clipper, or rectifier tubes, as well as magnetrons.

Combustible Materials. To prevent possible fuel ignition, an installed airborne weather radar should not be operated while an aircraft is being refueled or defueled.



M.C. Beard
 Director of Airworthiness
 AC 20-68B
 8/8/80

8/8/80
 AC-2068B
 Appendix 1

APPENDIX 1. SAFE DISTANCE DETERMINATION

The following information can be used in establishing a minimum safe distance from the antenna for personnel near an operating airborne weather radar.

NEAR FIELD/FAR FIELD INTERSECTION. The distance to the near field/far field intersection can be computed by:

$$R_i = \frac{G \lambda}{8 \pi} \tag{1}$$

where R_i = Intersection distance from the antenna (in meters)

λ = Wave length (in meters)

G = Antenna gain

DISTANCE TO 10 mw/cm2 SAFE LIMIT. For a far field power density of 10 mw/cm2, the distance (in meters) from the antenna may be calculated by:

$$R_s = \sqrt{\frac{GP}{400 \pi}} \tag{2}$$

where R_s = The minimum safe distance in meters.

P = Transmitted average power in watts.

G = Antenna gain

PROCEDURES. The above formulas or the graphs of figures 1 and 2 may be used to determine the minimum safe distance. In either case, the following procedures apply:

- a. Determine the distance (R_i) to the near field/far field intersection (paragraph 1).
- b. Determine the distance (R_s) to 10 mw/cm2 power density (paragraph 2).
- c. If the distance (R_s) determined in b above is less than (R_i) found in a above, use distance (R_i) as the minimum safe distance.
- d. If the distance (R_s) determined in b above is greater than (R_i) found in a above, use distance (R_s) as the minimum safe distance.

EXAMPLE.

Data. The following is typical data for the airborne weather radar.

Antenna Diameter	:22 inches=56 cm	Transmitter
Frequency	:9375 +30 Mhz	
Wave Length	:3.2 cm	
Pulse Length	:1.5 microseconds	(search)
Pulse Repetition	:400 Hz	
Peak Power	:40 kilowatts	
Average Power	:24 watts	(search)
Antenna Gain	:1000	(30 db)

Calculations:

(1) Distance (R_i) to the near field/far field intersection. (2) Distance (R_s) to 10 mw/cm2 safe limit.

$$R_i = \frac{G \lambda}{8 \pi} = \frac{1000 \times 0.032}{8 \pi} = 1.27 \text{ meters} = 4.2 \text{ feet}$$

$$R_s = \sqrt{\frac{GP}{400 \pi}} = \sqrt{\frac{1000 \times 24}{400 \pi}} = 4.37 \text{ meters} = 14.3 \text{ feet}$$

The distance (R_s) is greater than (R_i), therefore, the minimum safe distance is 14.3 feet.



Radiation

Warning

This instrument generates microwave radiation.

**DO NOT OPERATE UNTIL YOU HAVE READ
AND CAREFULLY FOLLOWED ALL SAFETY
PRECAUTIONS AND INSTRUCTIONS IN THE
OPERATING AND SERVICE MANUALS.**

**IMPROPER USE OR EXPOSURE MAY CAUSE
SERIOUS BODILY INJURY**

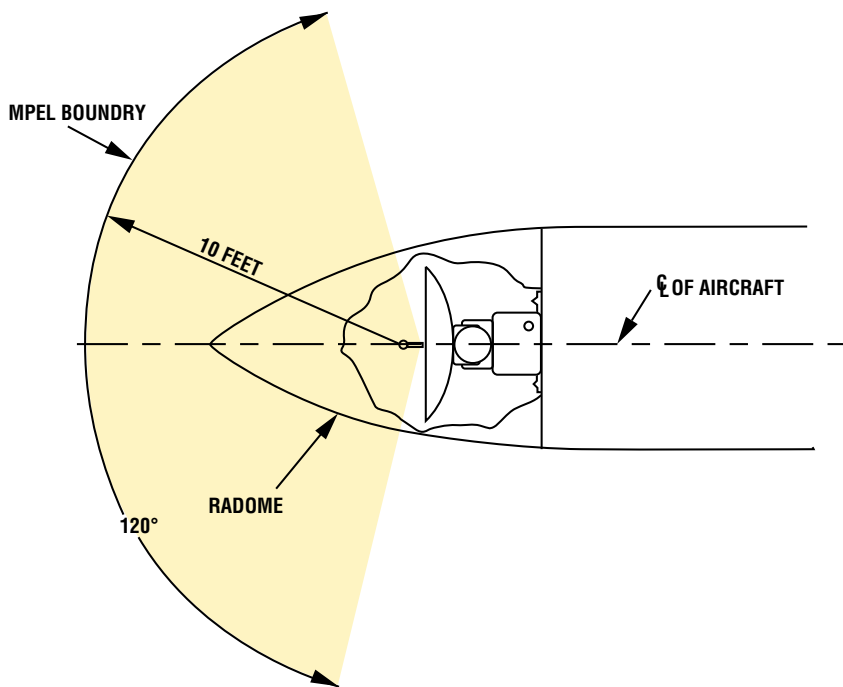
CAUTION:

- a. *MAINTAIN PRESCRIBED SAFE DISTANCE WHEN STANDING IN FRONT OF RADIATING ANTENNA.**
- b. *NEVER EXPOSE EYES OR ANY PART OF THE BODY TO AN UNTERMINATED WAVE GUIDE.*

**Reference FAA Advisory Circular #20-68*

Maximum Permissible Exposure Levels (MPEL)

In order to avoid the envelope in which the radiation level exceeds the U.S. Government standard of 10 mW per square centimeter, all personnel should remain beyond the distance indicated in the illustration below. The distance to the MPEL boundary is calculated upon the basis of the largest antenna available with the RDR 2000, rated output power of the transmitter and in the non-rotating or boresight position of the antenna. With a scanning beam, the power density at the MPEL boundary is significantly reduced.



List of Effective Pages

<u>Page</u>	<u>Rev</u>	<u>Date</u>
i	Rev 3	5/98
ii	Rev 3	5/98
1	Rev 3	5/98
2	Rev 3	5/98
3	Rev 3	5/98
4	Rev 3	5/98
5	Rev 3	5/98
6	Rev 3	5/98
7	Rev 3	5/98
8	Rev 3	5/98
9	Rev 3	5/98
10	Rev 3	5/98
11	Rev 3	5/98
12	Rev 3	5/98
13	Rev 3	5/98
14	Rev 3	5/98
15	Rev 3	5/98
16	Rev 3	5/98
17	Rev 3	5/98
18	Rev 3	5/98
19	Rev 3	5/98
20	Rev 3	5/98
21	Rev 3	5/98
22	Rev 3	5/98
23	Rev 3	5/98
24	Rev 3	5/98
25	Rev 3	5/98
26	Rev 3	5/98
27	Rev 3	5/98
28	Rev 3	5/98
29	Rev 3	5/98
30	Rev 3	5/98
31	Rev 3	5/98
32	Rev 3	5/98
33	Rev 3	5/98
34	Rev 3	5/98
35	Rev 3	5/98
36	Rev 3	5/98
37	Rev 3	5/98
38	Rev 3	5/98

List of Effective Pages

<u>Page</u>	<u>Rev</u>	<u>Date</u>
39	Rev 35/98
40	Rev 35/98
41	Rev 35/98
42	Rev 35/98
43	Rev 35/98
44	Rev 35/98
45	Rev 35/98
46	Rev 35/98
47	Rev 35/98
48	Rev 35/98
49	Rev 35/98
50	Rev 35/98
51	Rev 35/98
52	Rev 35/98
53	Rev 35/98
54	Rev 35/98
55	Rev 35/98
56	Rev 35/98
57	Rev 35/98
58	Rev 35/98
59	Rev 35/98
60	Rev 35/98
61	Rev 35/98
62	Rev 35/98
63	Rev 35/98
64	Rev 35/98
65	Rev 35/98
66	Rev 35/98

AlliedSignal, Inc.
Electronic and Avionics Systems
One Technology Center
23500 West 105th Street
Olathe, Kansas 66061
FAX 913-791-1302
TELEPHONE (913) 782-0400

© 1996 -1998 AlliedSignal Inc.

006-08755-0001 Printed in USA
Revision 3 5/98

