



July 28, 2011

ULA Rideshare Capabilities

Jake Szatkowski
Business Development
& Advanced Programs



Rideshare Missions

- ULA's family of expendable launch vehicles has a long history of providing high-value payload accommodations for a variety of customer spacecraft & missions throughout the solar system





ULA PLANETARY MISSIONS (Since 2001)	VEHICLE	LAUNCH DATE	DESTINATION
Mars Odyssey	Delta II 7925	4/7/2001	Mars
CONTOUR	Delta II 7425	7/3/2002	Comet
Mars Rover A (Spirit)	Delta II 7925	6/10/2003	Mars
Mars Rover B (Opportunity)	Delta II 7925H	7/7/2003	Mars
MESSENGER	Delta II 7925H	8/3/2004	Mercury
Deep Impact	Delta II 7925	1/12/2005	Comet
Mars Reconnaissance Orbiter	Atlas V 401	8/12/2005	Mars
New Horizons	Atlas V 551	1/19/2006	Pluto
STEREO	Delta II 7925	10/25/2006	Sun (Earth orbit)
Phoenix	Delta II 7925	8/4/2007	Mars
Dawn	Delta II 7925H	9/27/2007	Asteroid Belt
Lunar Reconnaissance Orbiter	Atlas V 401	6/18/2009	Moon

- Most of these missions were launched as primary payloads and used the full capability of the launch vehicle, but there are lower-cost alternatives for achieving these science objectives

Rideshare Concept

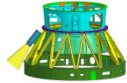
- ❑ What is Rideshare?
 - Sharing available performance and volume margin that would otherwise go unused by the primary payload
- ❑ Advantages to Rideshare
 - Provides an inexpensive and reliable solution
 - Cost-savings allows more funding to be applied to the science mission
 - Rideshare payload receives the benefits of full-up launch service
- ❑ Successfully demonstrated in 2009, with LCROSS was flown as a secondary payload on an Atlas V that launched the LRO

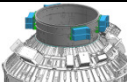
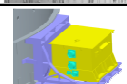
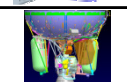
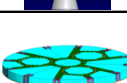
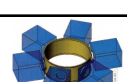
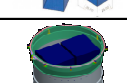
ULA Rideshare Capability Overview

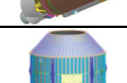
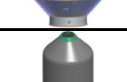
CAPABILITY	MAXIMUM MASS PER PAYLOAD	VOLUME	INTERFACE	MAXIMUM # / LAUNCH	COMPATIBILITY			STATUS
					DII	DIV	AV	
Delta II Second-Stage Mini-Skirt 	1.0 kg (2.2 lb)	10 cm ³ (4 in ³)	P-POD	6 Cubesats	X			ILC 2011
Delta IV Equipment Shelf 	1.0 kg (2.2 lb)	10 cm ³ (4 in ³)	P-POD (NPSCuL)	24 Cubesats		X		Concept Development
ULA EELV P-POD 	1.0 kg (2.2 lb)	10 cm ³ (4 in ³)	P-POD	24 Cubesats		X	X	Concept Development
CAP (C-Adapter Platform) 	45 kg (100 lb)	23 cm x 31 cm x 33 cm (9 in x 12 in x 13 in)	15" clampband	4		X	X	ILC 2012
ABC (Aft Bulkhead Carrier) 	77 kg (170 lb)	51 cm x 51 x 76 cm (20 in x 20 in x 30 in)	15" clampband or P-POD	1			X	ILC 2012
A-DECK (Auxiliary Payload Deck) (Adaptive Launch Solutions) 	905 kg (2,000 lb)	152-cm dia. (60-in dia.)	15", 23", 37" clampband	1		X	X	ILC 2012
ESPA (EELV Secondary Payload Adapter) (Moog CSA Engineering) 	180 kg (400 lb)	61 cm x 71 cm x 96 cm (24 in x 28 in x 38 in)	15" bolted	6		X	X	Operational
IPC (Integrated Payload Carrier) 	910 kg (2,000 lb)	137-cm dia. (54-in dia.)	8", 15", 37" clampband	1		X	X	Operational
XPC (External Payload Carrier) (Special Aerospace Services) 	1,590 kg (3,500 lb)	20.1 m ³ (710 ft ³)	60" diameter	1			X	PDR 12/2010
DSS-4M (Dual Spacecraft System - 4M) 	2,270 kg (5,000 lb)	254-cm dia. x 127 cm (100-in dia. x 50 in)	37" clampband	1		X	X	ILC 2012
DSS-5M (Dual Spacecraft System - 5M) 	5,000 kg (11,000 lb)	4-m dia. x 6.1 m (13.1-ft dia. x 20 ft)	62" bolted	1		X	X	Concept Development

C-Adapter Platform (CAP)

❑ Description

- A cantilevered platform attached to the side of a C-adapter to accommodate secondary payloads
- Alt config: flat plate using same brackets w/ 15 in. sep ring

❑ Capabilities

- Mass: 45 kg (100 lb)
- Volume: 23 cm x 31 cm x 33 cm (9 in x 12 in x 13 in)
- Interface: 15-in clampband
- Capacity: 4 slots
- Vehicle: Atlas V, Delta IV

❑ Status

- First launch 2012

❑ Why?

- Can be used to advance TRL for electronics into the Van Allen Belt

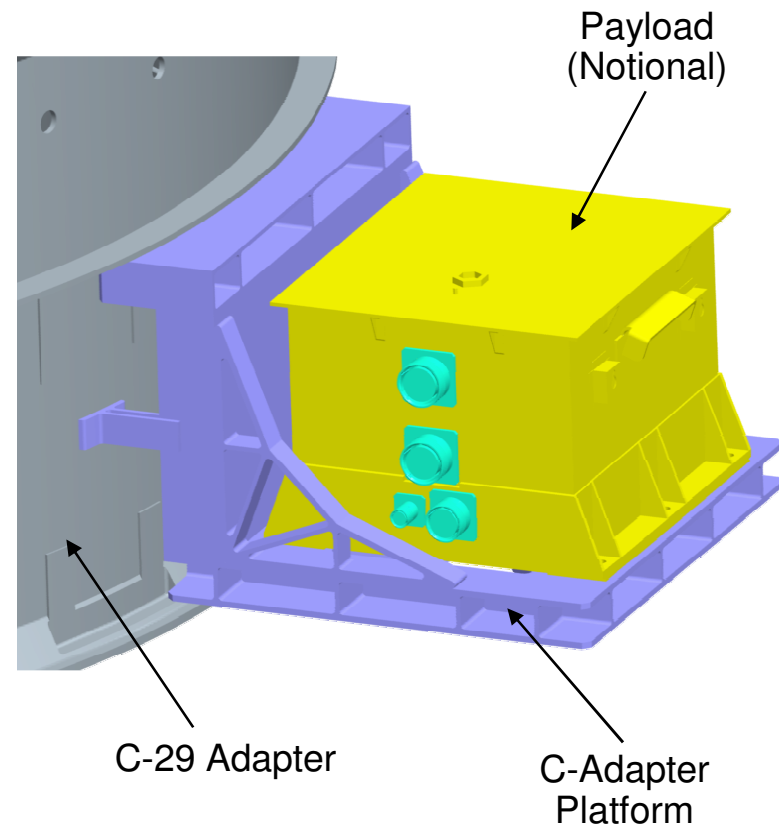

Aft Bulkhead Carrier (ABC)

- ❑ Description
 - I/F located at the aft-end of the Atlas V Centaur second-stage
- ❑ Capabilities
 - Mass: 77 kg (170 lb)
 - Volume: 51 cm x 51 cm x 76 cm (20 in x 20 in x 30 in)
 - Interface: 15-in clampband or P-POD dispenser
 - Capacity: 1 slot
 - Vehicle: Atlas V
- ❑ Status
 - First launch 2012 (NROL-36)
 - ABC Users Guide available 9/11
- ❑ Why?
 - Sep from primary – release any time, no contamination, no re-contact, no security

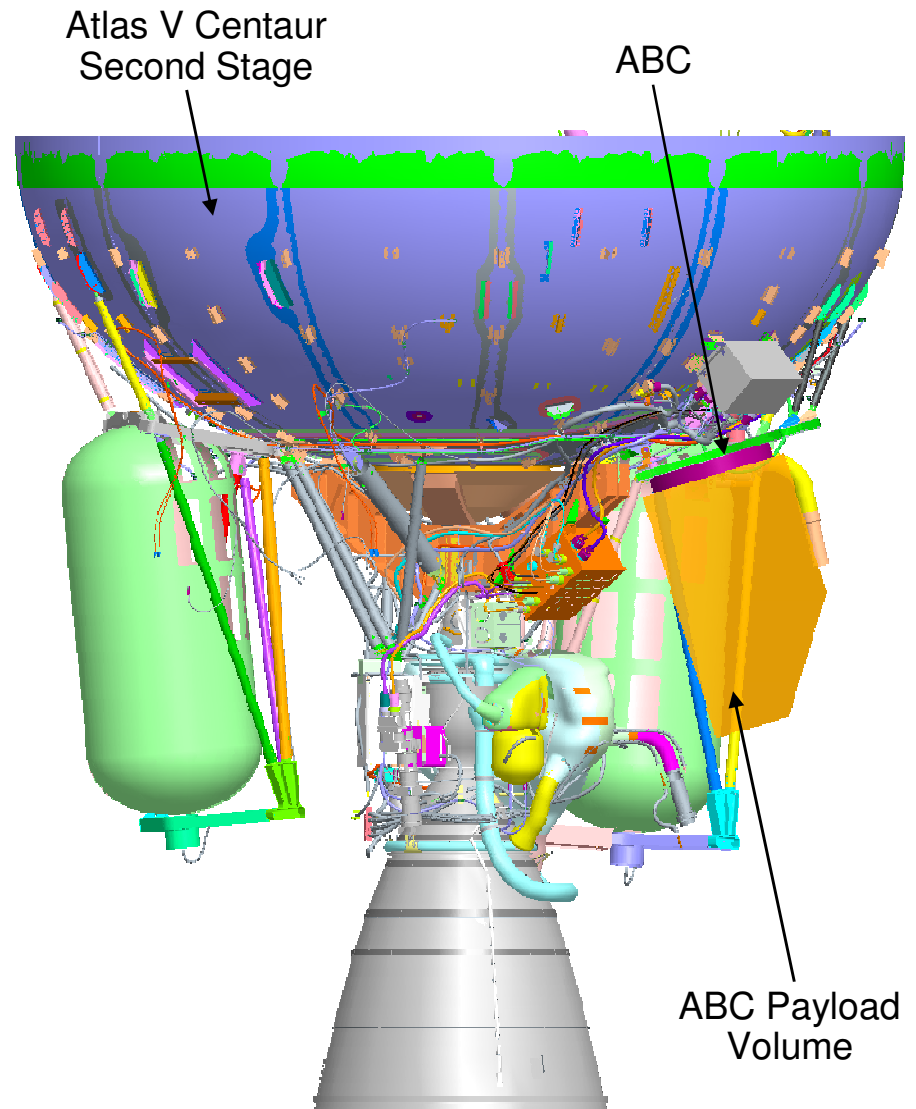

Integrated Payload Carrier (IPC)

- ❑ Description
 - A flexible **stack of ring segments**
 - Config: **conic or A-Deck**
- ❑ Capabilities
 - Mass: 910 kg (2,000 lb)
 - Volume: 137-cm dia. (54-in dia.)
 - Vehicle: Atlas V, Delta IV
- ❑ Status
 - Operational
- ❑ Why?
 - Large volume
 - on centerline
 - treated as single SC
 - height up to 7 ft

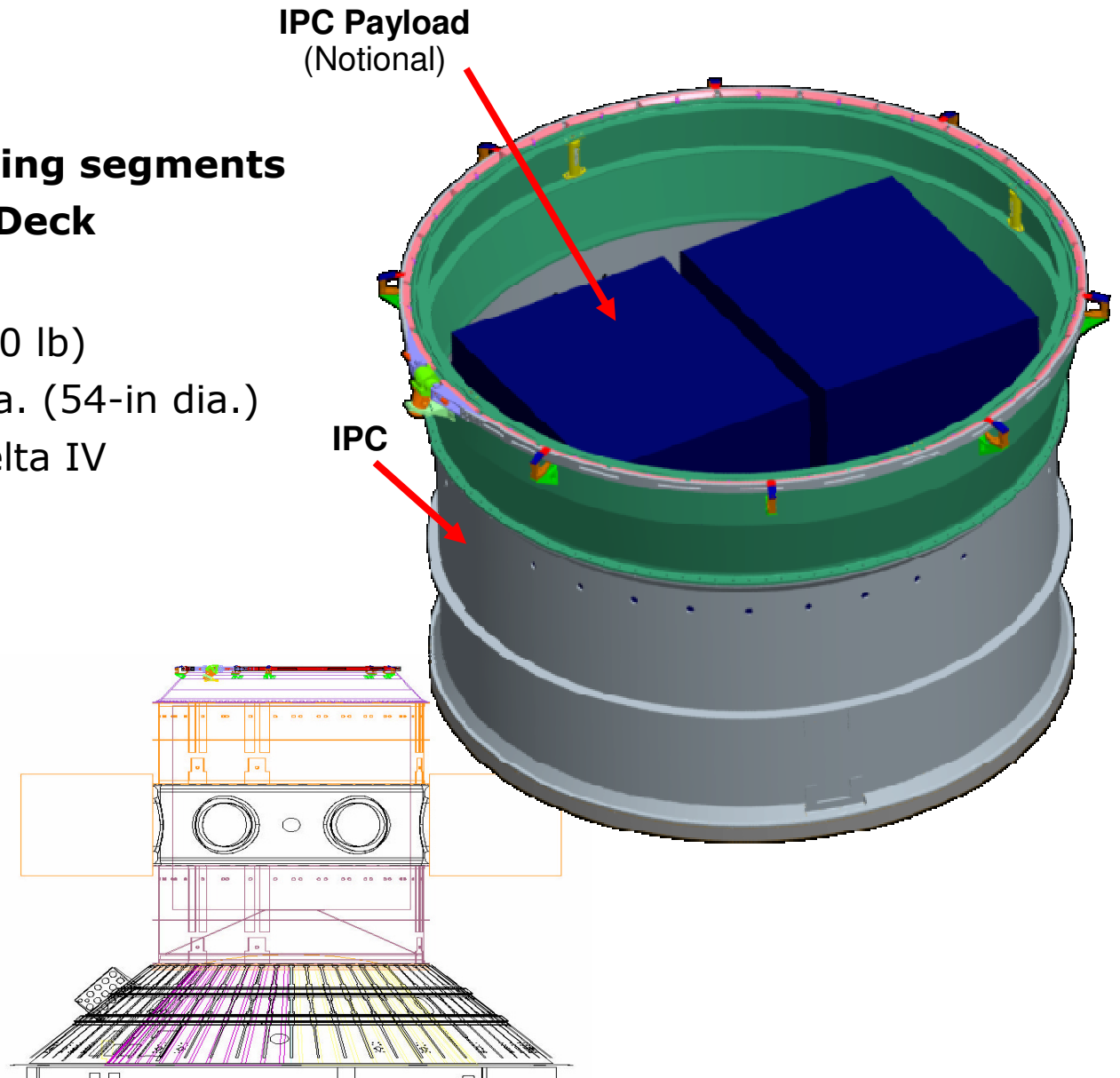

EELV Secondary Payload Adapter (ESPA)

□ Description

- An adapter located between the second-stage and the primary payload, which can accommodate up to six secondary payloads

□ Capabilities

- Mass: 180 kg (400 lb)
- Volume: 61 cm x 71 cm x 96 cm (24 in x 28 in x 38 in)
- Interface: 15-in bolted
- Capacity: 6 slots
- Vehicle: Atlas V, Delta IV
- Developer: Moog CSA Engineering

□ Status

- Operational
- ESPA Rideshare Users Guide currently available

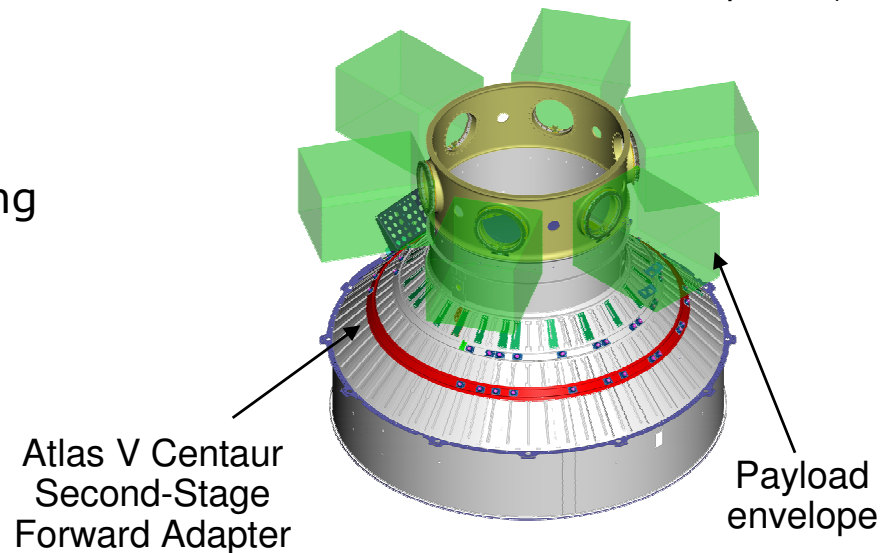
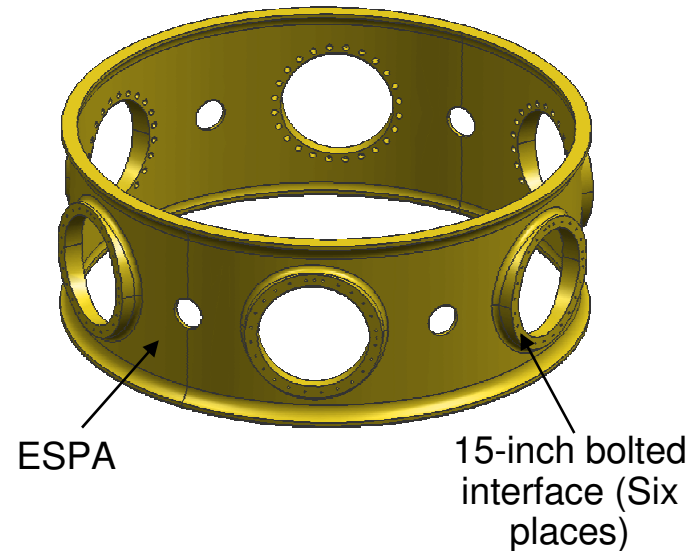

Electric 3rd-Stage

- The **ESPA TUG (Transfer Utility Guide)** provides high deltaV to perform delivery of ESPA class payloads to a variety of orbits and Earth Escape missions
 - Delivery to Earth Escape (Lunar, NEO, Mars)
 - Delivery of a constellation suite
 - Delivery to GSO
 - High delta-V
 - Solar Electric propulsion
 - Based on the ESPA Ring

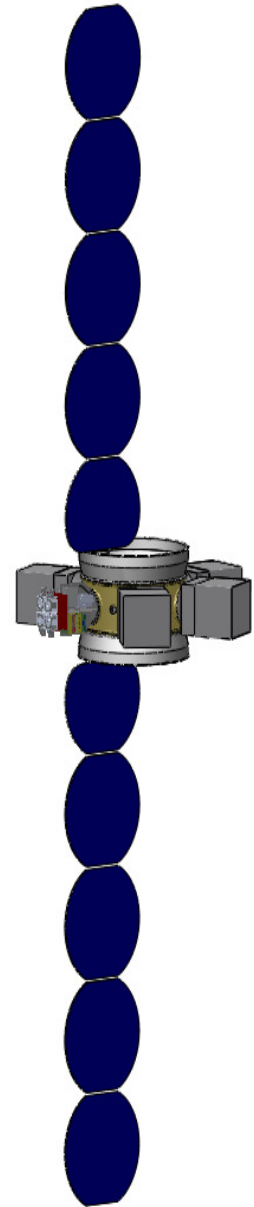

Dual Spacecraft System, 4-m (DSS-4)

❑ Description

- A modular dual-manifest launch capability for 4m fairings, using Centaur Forward Assembly hardware

❑ Capabilities

- Mass: 2,270 kg (5,000 lb)
- Volume: 254-cm dia. x 127 cm (100-in dia. x 50 in)
- Interface: Variable
- Capacity: 1 slot
- Vehicle: Atlas V, Delta IV

❑ Status

- CDR Dec 2009

❑ Why?

- Can lift 2 Delta-II class S/C, variable stack height, 10,000 lb upper w/ 5,000 lb lower

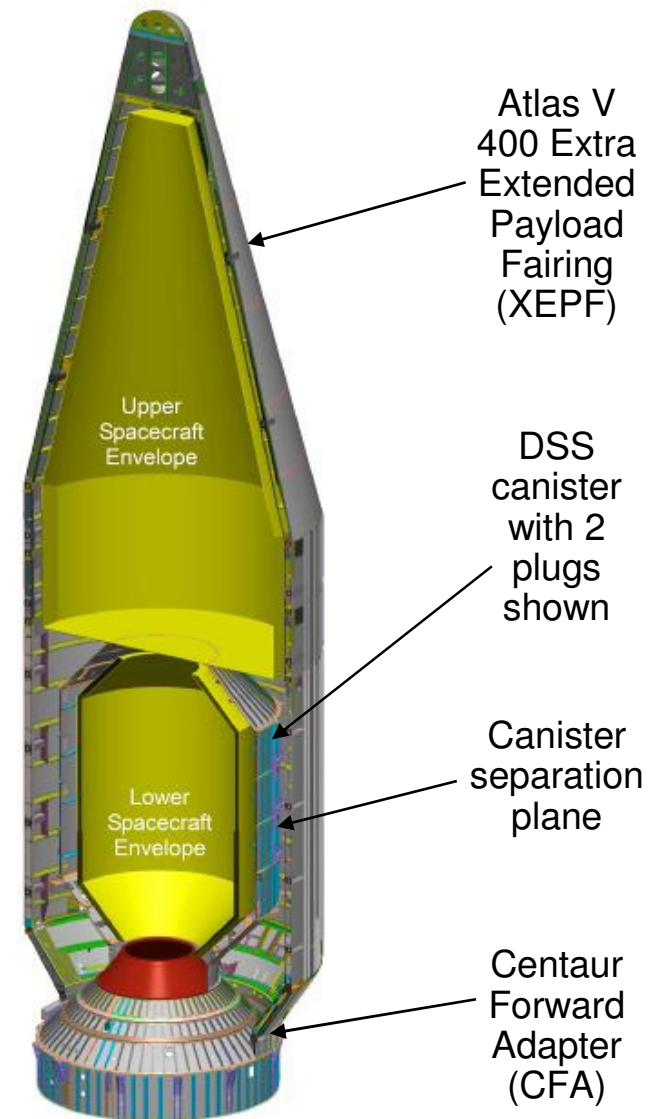

Dual Spacecraft System, 5-m (DSS-5)

- ❑ Description
 - A dual-manifest launch capability for 5-m fairings, using newly designed composite structure
- ❑ Capabilities
 - Mass: 5,000 kg (11,000 lb)
 - Volume: 4-m dia. x 6.1 m (13.1-ft dia. x 20 ft)
 - Interface: 62-in Bolted
 - Capacity: 1 slot
 - Vehicle: Atlas V, Delta IV
- ❑ Status
 - Concept Development
- ❑ Why?
 - Can support 2 GPS III S/C

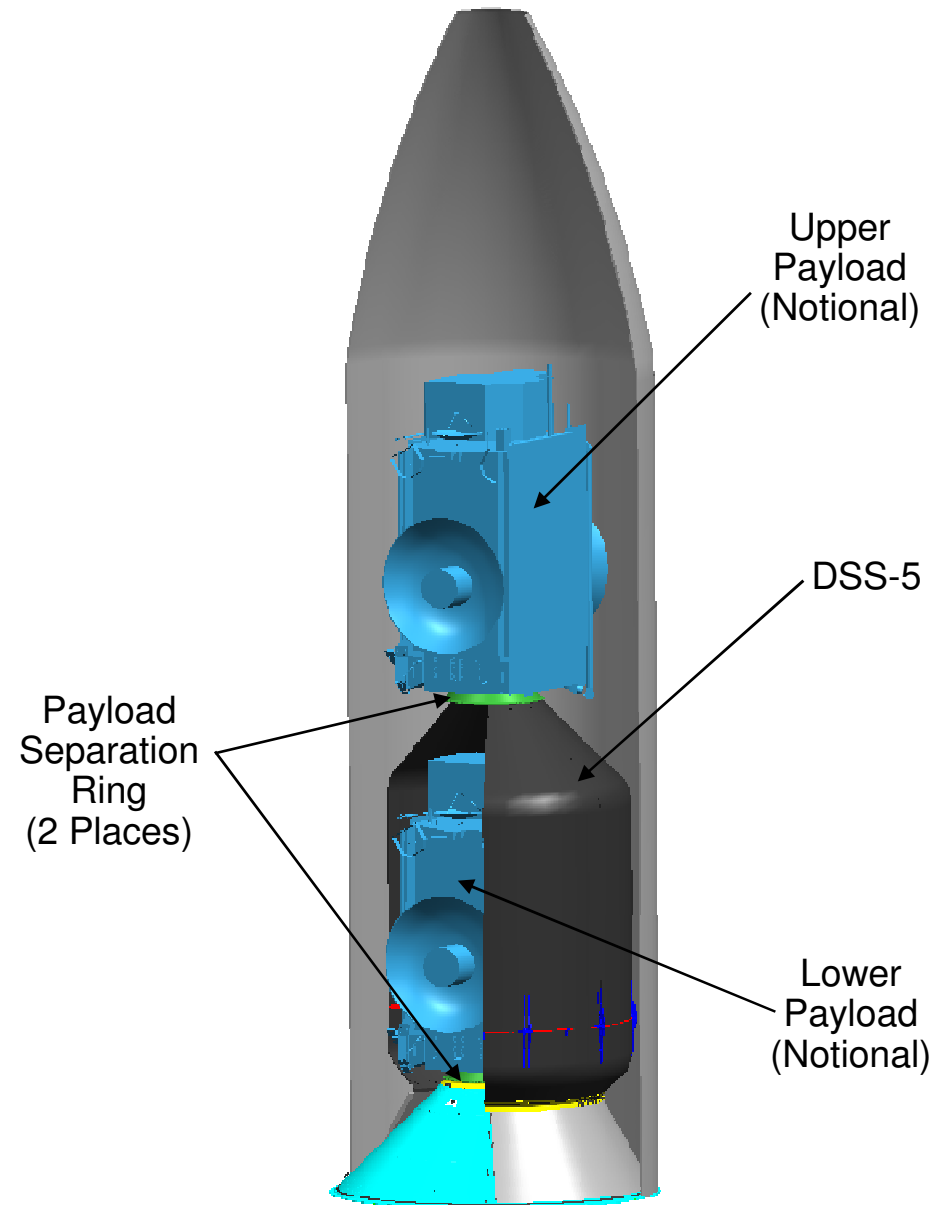

eXternal Payload Carrier (XPC)

- ❑ Description
 - An inert Solid Rocket Motor to hold small payloads for injection into a hypersonic suborbital trajectory
- ❑ Capabilities
 - Mass: 8000 lb
 - Volume: 60" diameter x 70 ft
 - Payload: ~3500 lb
 - Capacity: 1 SRM slot
- ❑ Status
 - Tailored PDR
- ❑ Why?
 - XPC goes ballistic w/ the booster
 - 900,000 ft going Mach 14,
 - ideal for Mars re-entry or SCRAMjet technology,
 - will have 6 min. of 0-g

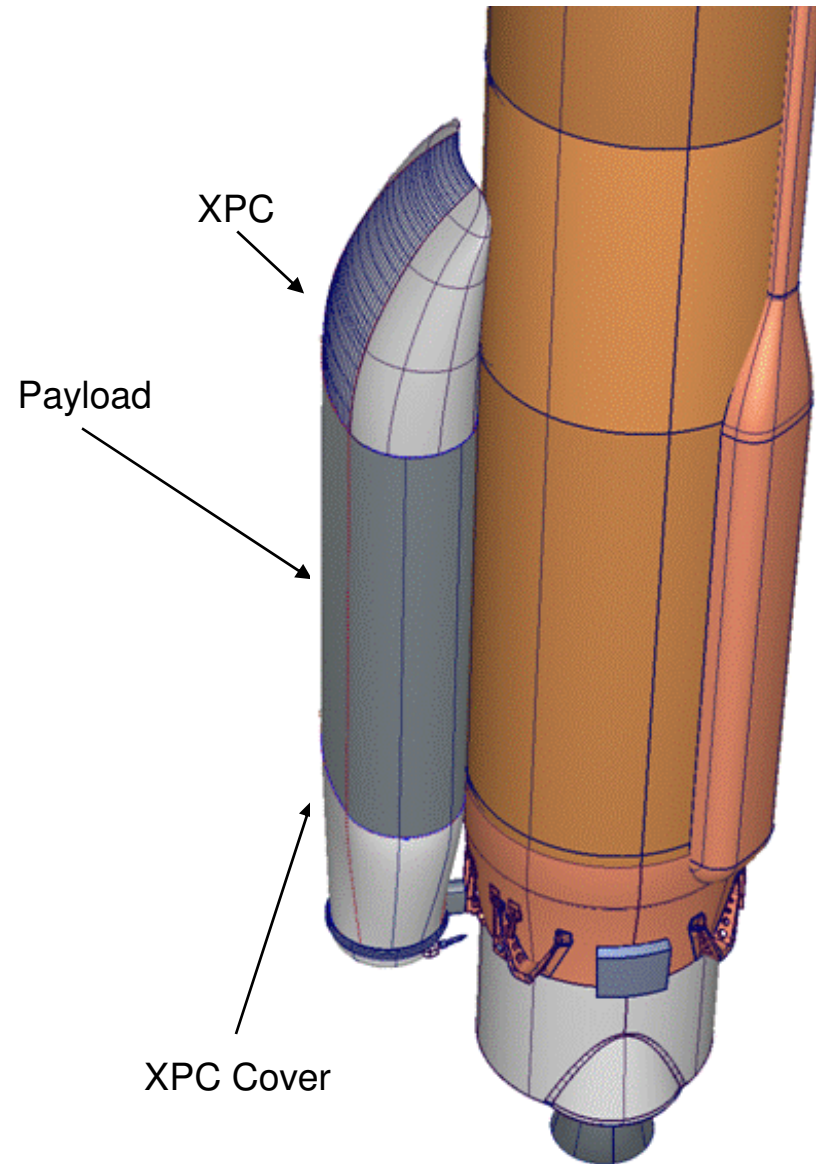

Potential Rideshare Opportunities

- All potential mission opportunities will need to be:
 - Assessed for technical compatibility
 - Coordinated and approved by the primary payload customer

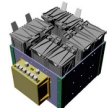
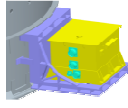
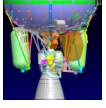
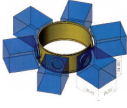
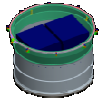
MISSION	TIMEFRAME	ORBIT TYPE	PROSPECTIVE CAPABILITY MATCHUPS				
			 P-POD	 CAP	 ABC	 ESPA	 IPC
AEHF	2011-2020	GTO	X		x		
DMSP	2012-2015	LEO (WR)	X	X	X	X	
GPS IIF	2010-2015	MEO	X	X	X	X	X
GPS III	2014-2020	MEO	X	X	X		
SBIRS	2011-2020	GTO	X	X	X		
LDCM	2012	LEO (WR)	TBD				
MMS	2014	GTO	TBD				
RBSP	2012	GTO	X	X	X	X	
TDRS	2012-2017	GTO	X	X	X		
CLS 1	2013	LEO	X	X	X	X	X
CLS 2	2014	LEO	X	X	X	X	X

Rideshare Spectrum of Capabilities

A range of capabilities address differing size, mass, and other requirements and provide individual operational advantages

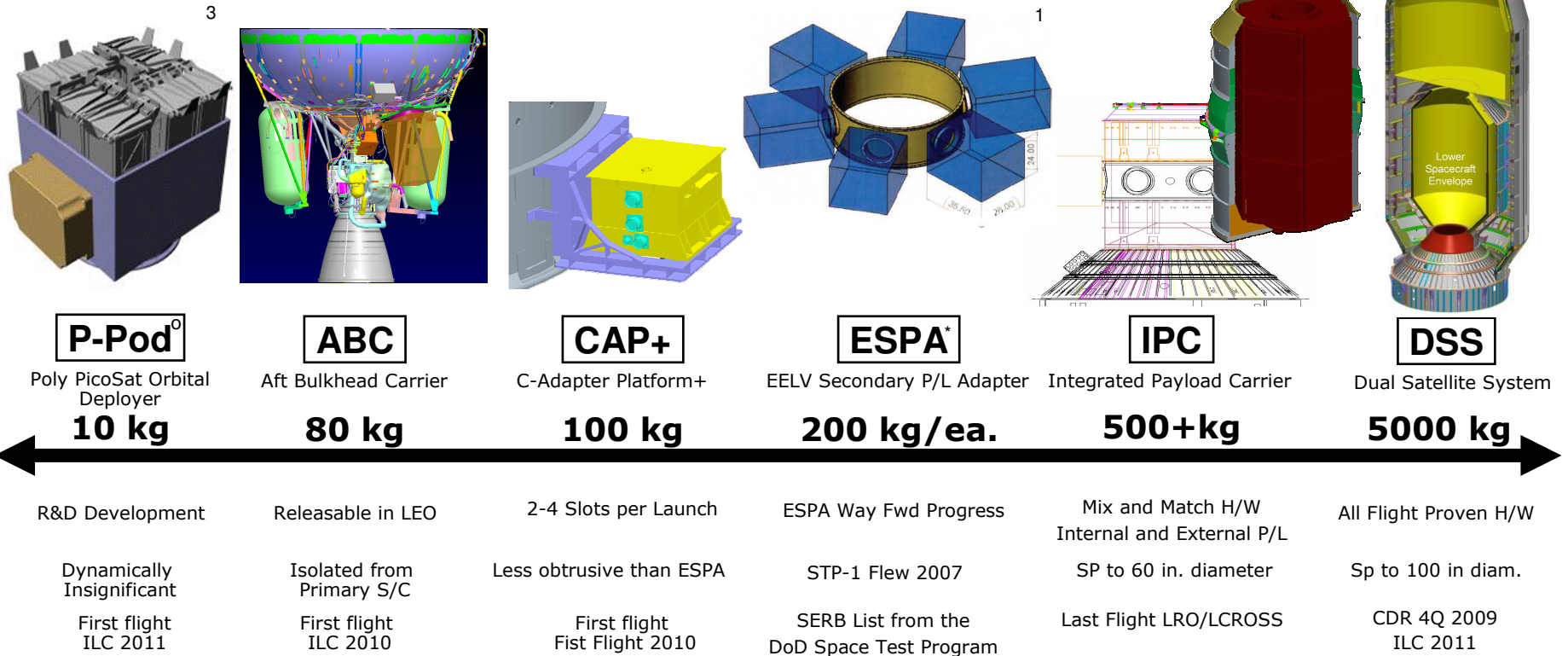

Delivering a Wide Range of Small Spacecraft with the Appropriate Conops and Technical Accommodations

1 ESPA Graphic courtesy of CSA Engineering, Inc
 2 COTSAT courtesy of NASA/AMES
 3 NPSCuL courtesy of NPS